

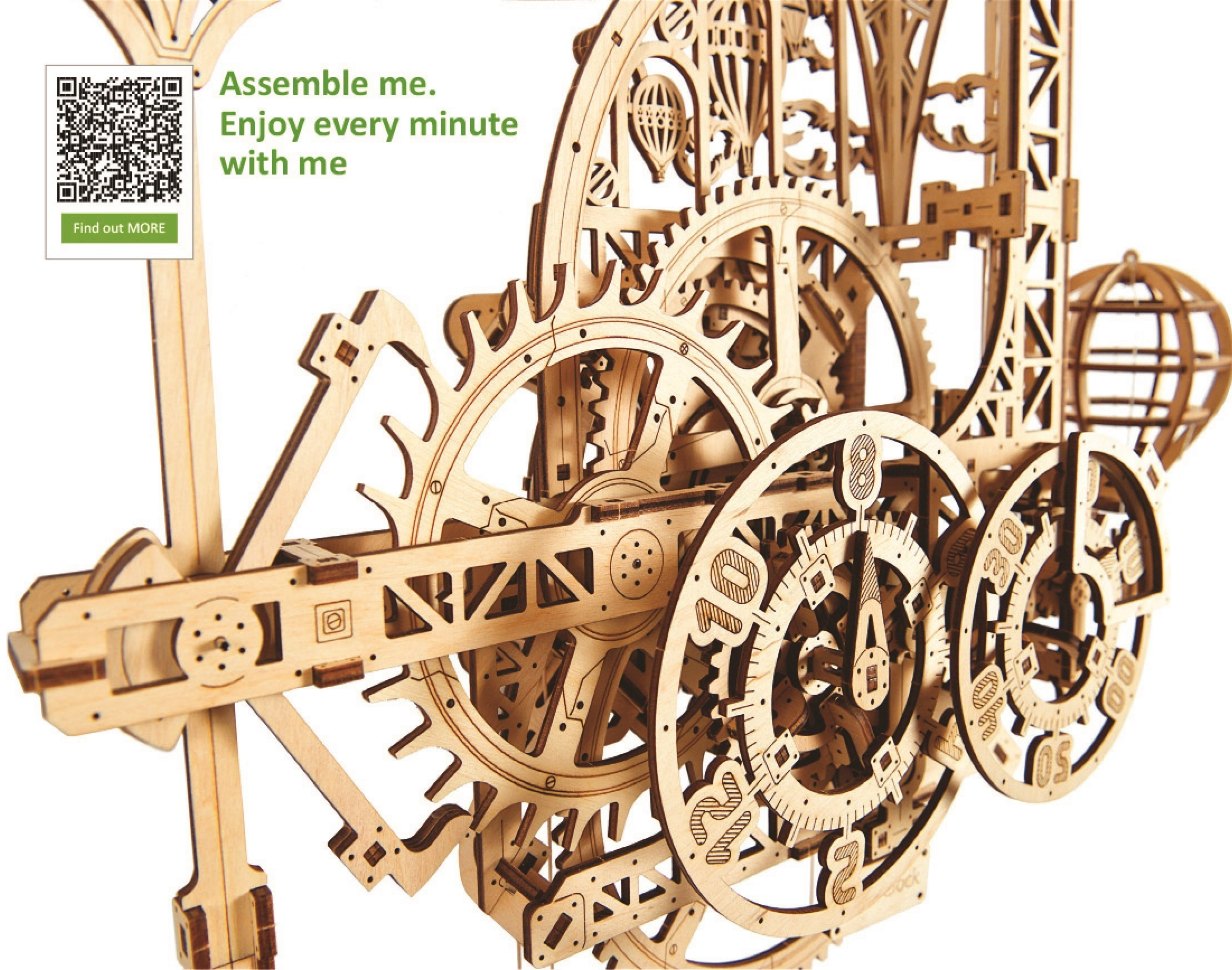

Find out MORE

Assemble me.  
Enjoy every minute  
with me



  
UGEARS®  
Mechanical models

## Aero Wandklok met Slinger

Handleiding in het Nederlands



MECHANICAL  
МЕХАНІЧНІ



NO GLUE CONNECTION  
БЕЗ КЛЕЮ



PLYWOOD  
З ФАНЕРИ



EDUCATIONAL  
ПІЗНАВАЛЬНІ

## NED

### Bouwinstructies.

Verwijder de onderdelen van de borden zoals hieronder is geïllustreerd. Pas op dat de onderdelen niet breken. Wanneer het niet loskomt, gebruik dan voorzichtig een mesje. Dit model bouwt u zelf zonder gebruik te maken van lijm. Wanneer onderdelen moeilijk te plaatsen zijn. Smeer deze dan in met een kaars. Om frictie te voorkomen behandelt u ook alle beweegbare onderdelen met een kaars.

### Waarschuwing!



Gebruik geen kaars die brand!



Opgepast, de spieën zijn scherp!

## Pictogrammen.

-  Opgelet! Controleer de goede positie.
-  Schuur om de bramen te verwijderen.
-  Smeer het onderdeel in met kaarsvet.
-  Controleer grootte.
-  Druk de onderdelen aan zover als ze willen gaan.
-  Knippen (elastiek, draad enz.).
-  Controleer het mechanisme op een soepele en goede beweging. Breng het mechanisme in beweging om de onderdelen in positie te krijgen.
-  Overtuig u ervan dat de onderdelen goed zijn uitgelijnd met de andere onderdelen voor u ze goed aandrukt.
-  Snijd dwarsstukken voordat u het onderdeel van het bord verwijdert.
-  Het onderdeel moet gemakkelijk te draaien zijn.



## + Reserveonderdelen.

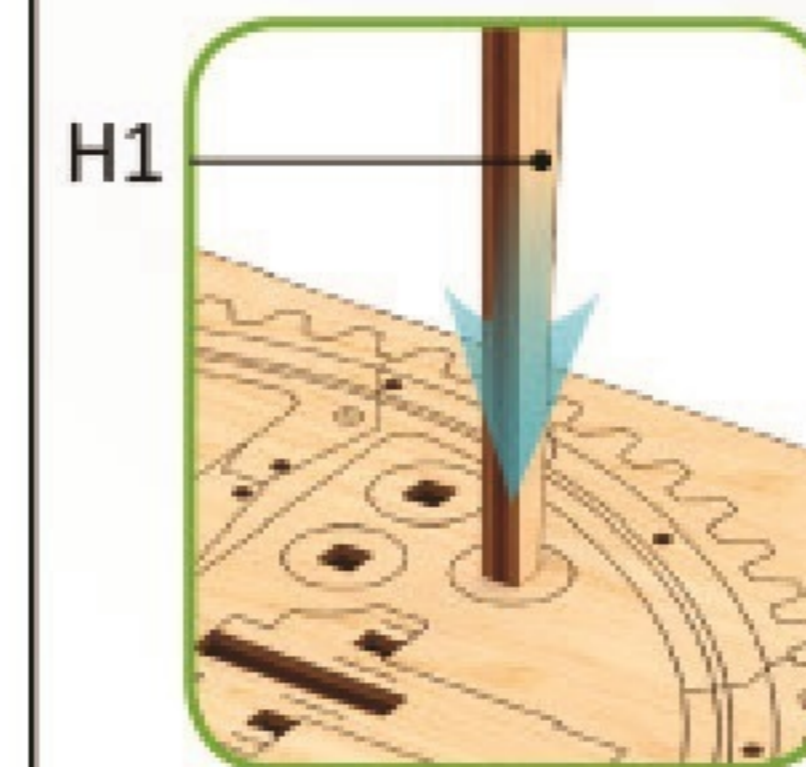
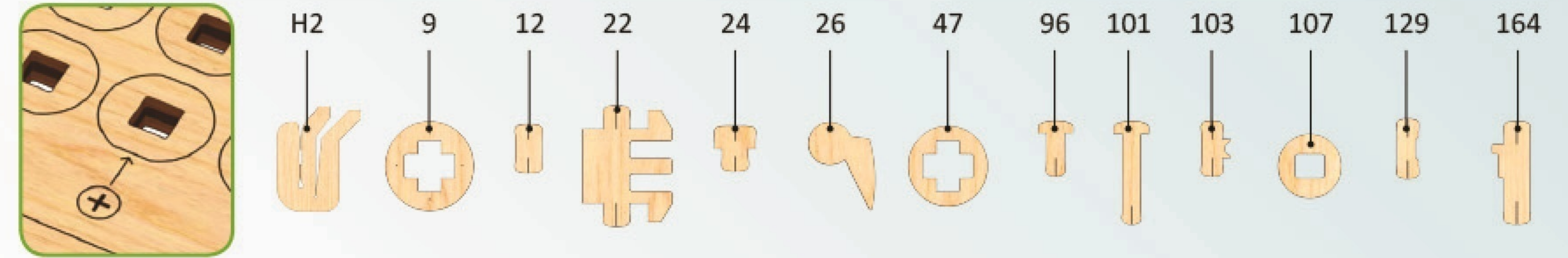

Dit is geen onderdeel. Het is een gereedschap voor meting en montage. Leder model heeft z'n eigen gereedschap.

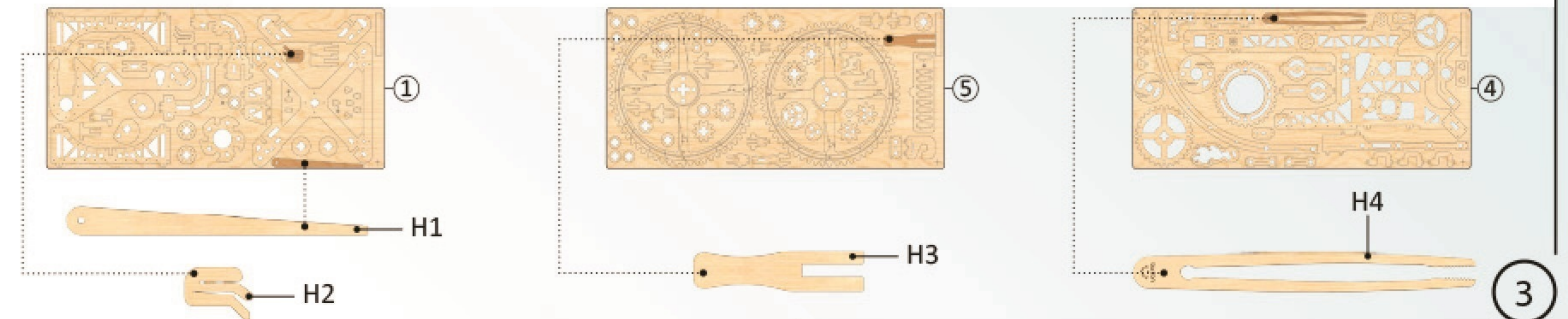

Mechanical models

Het is gemakkelijker om sommige onderdelen eruit te trekken met de helper "H1".

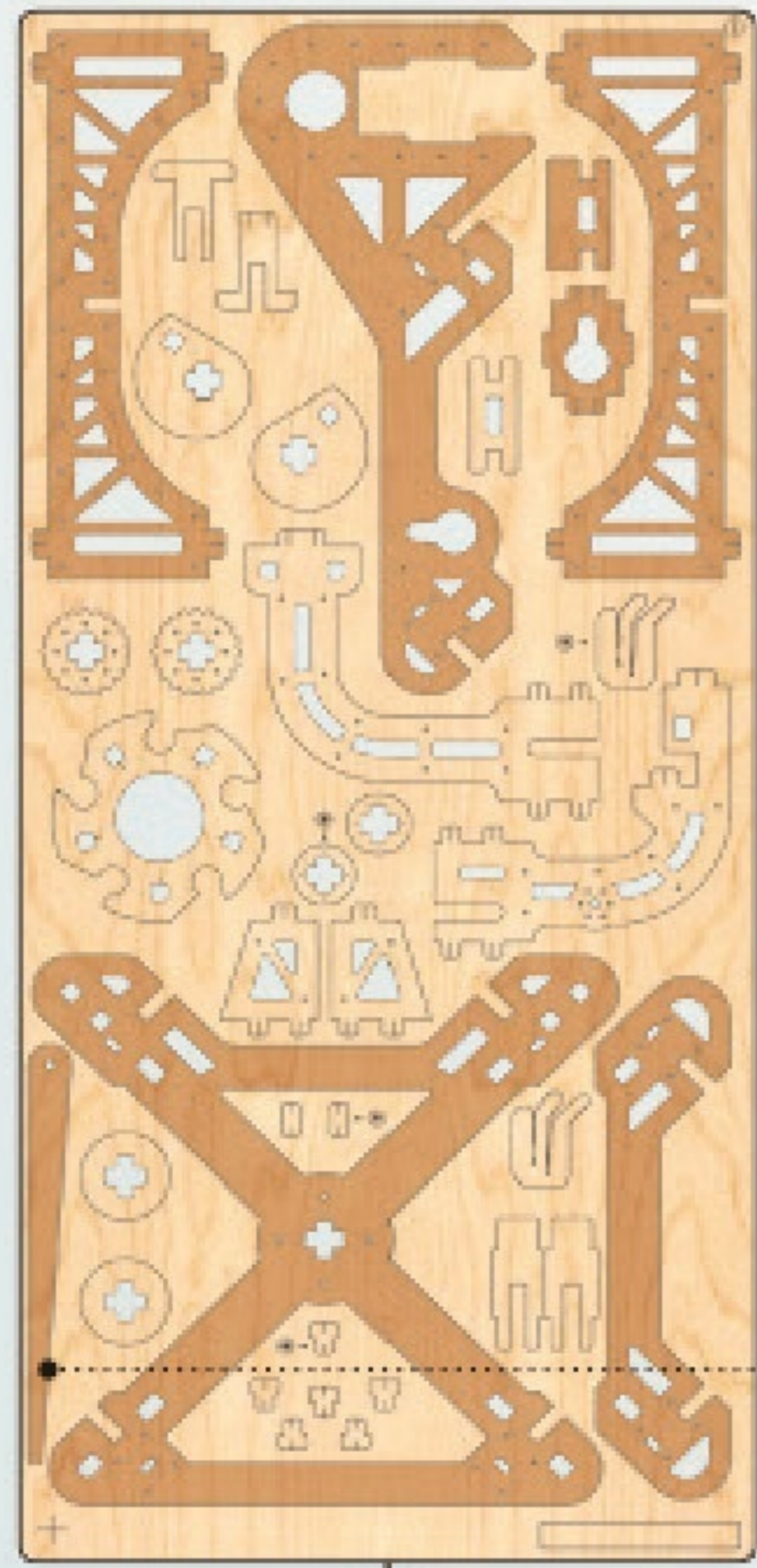

1



1

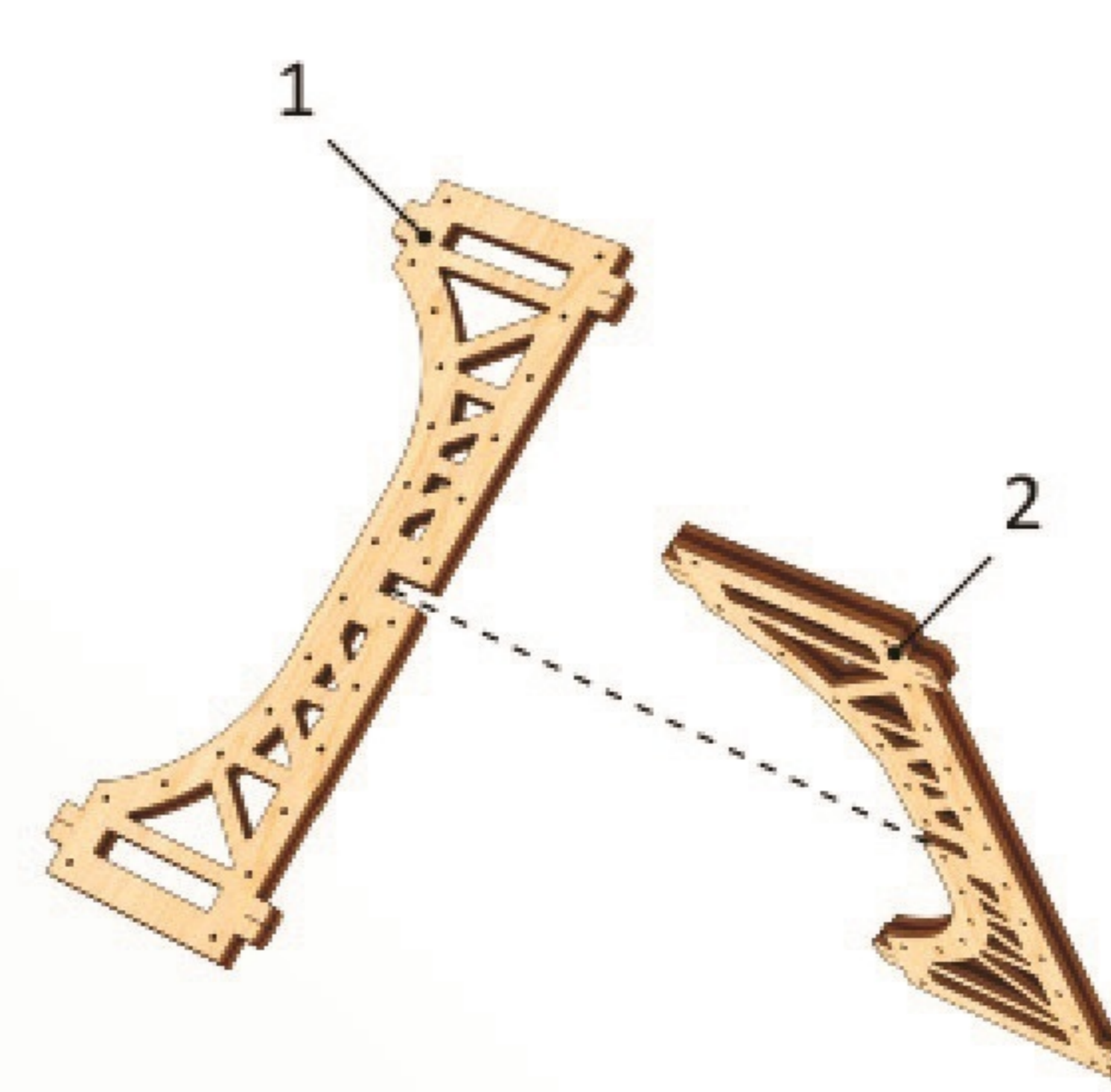

2

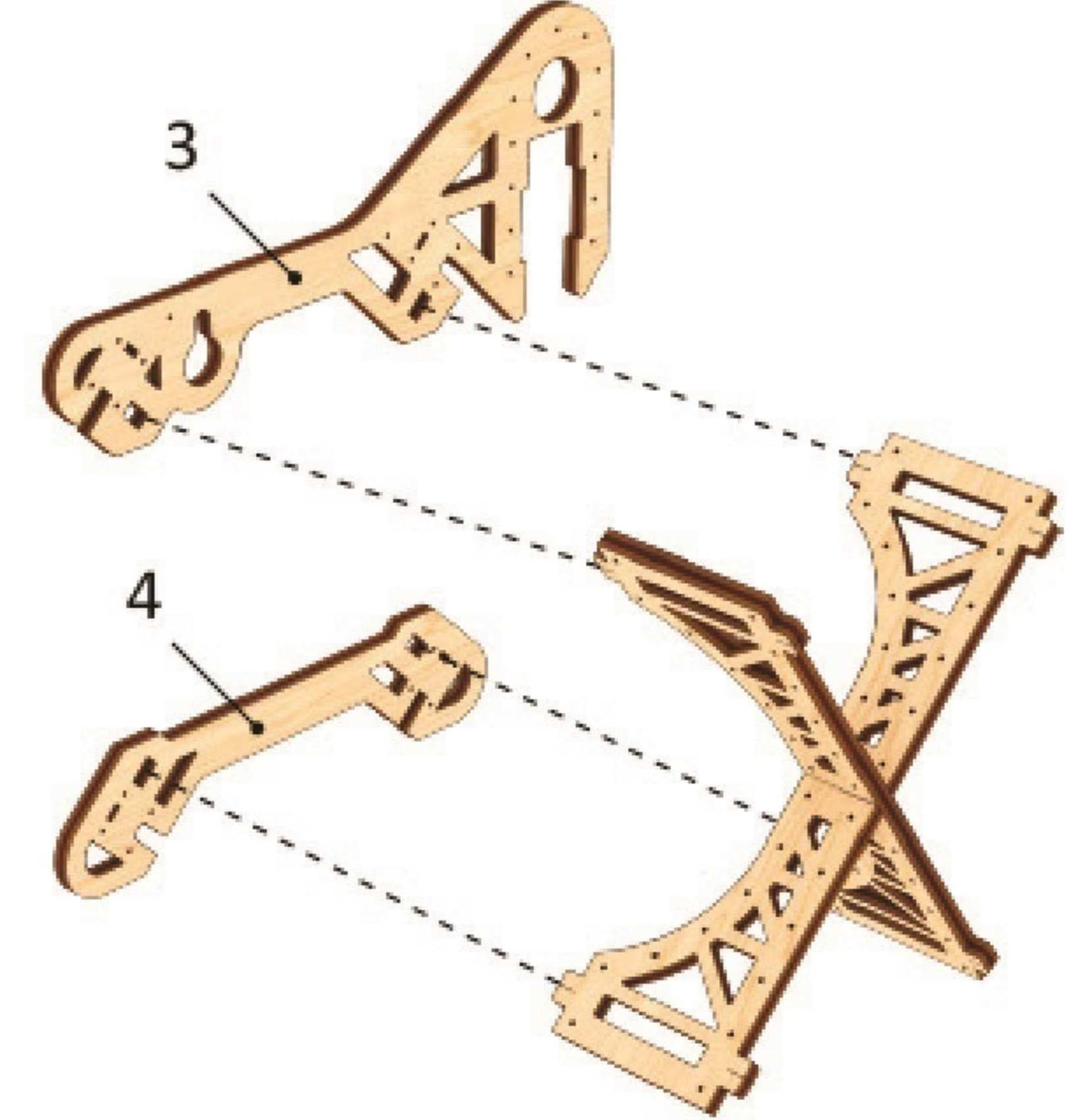

3

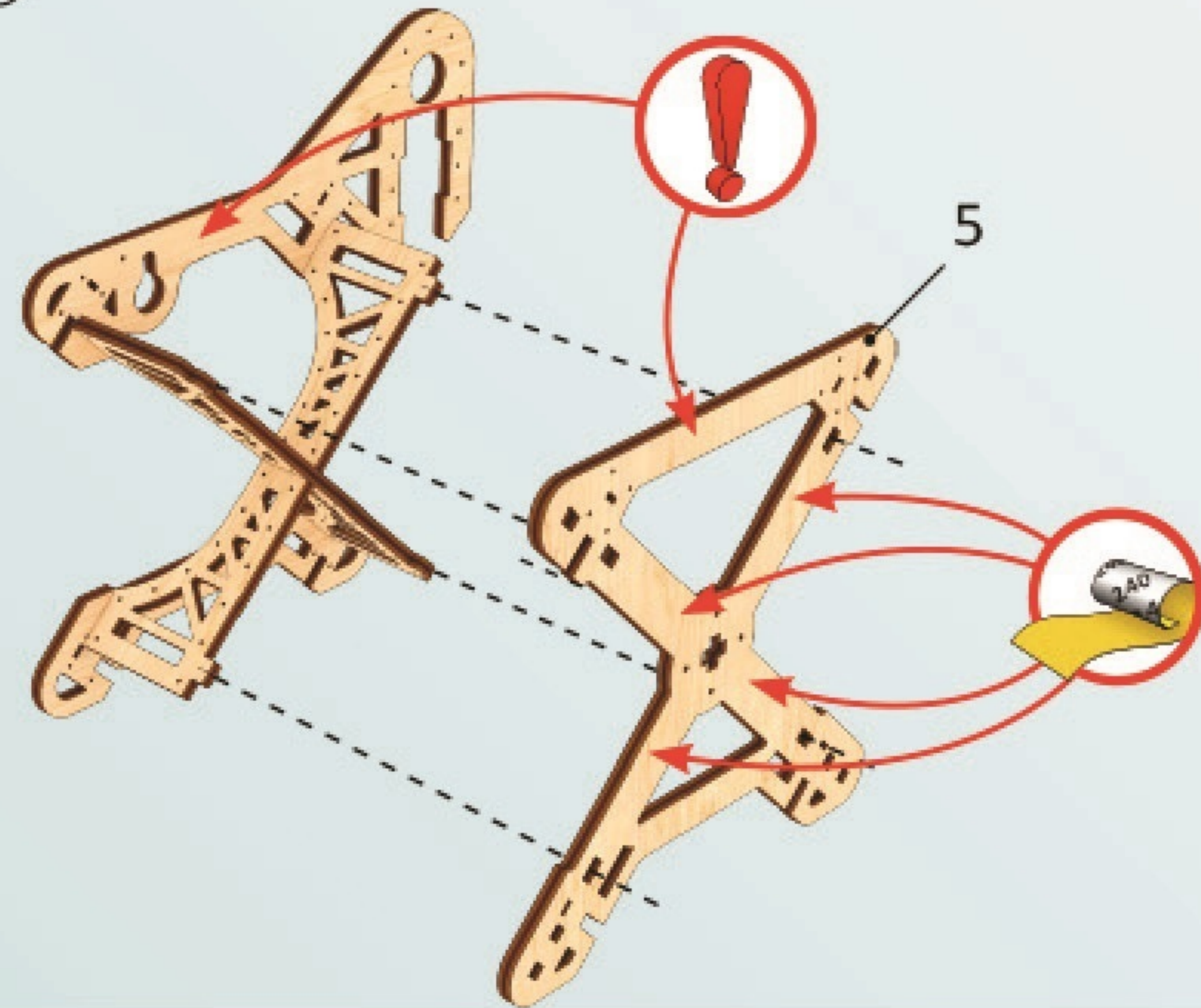

4

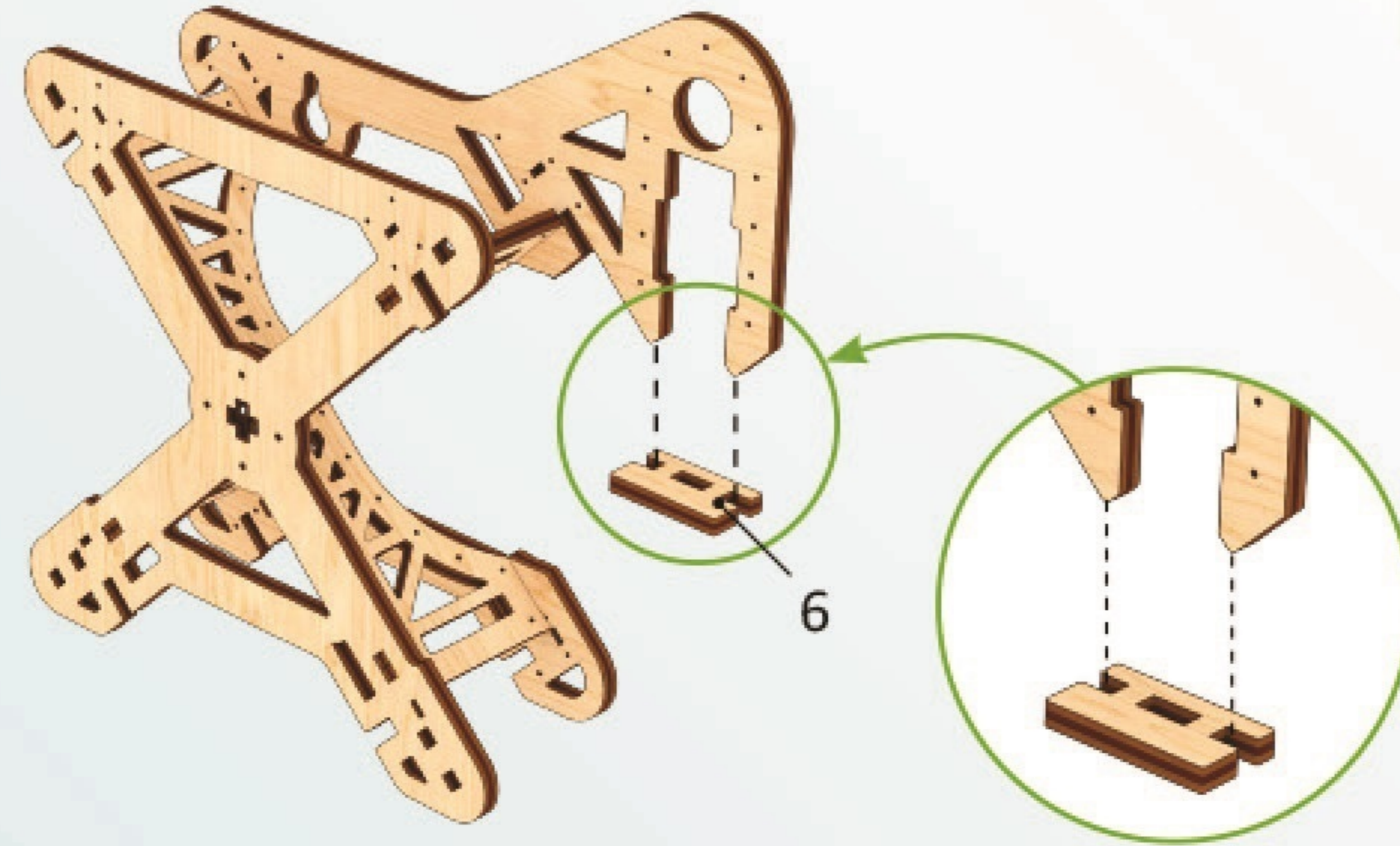

5

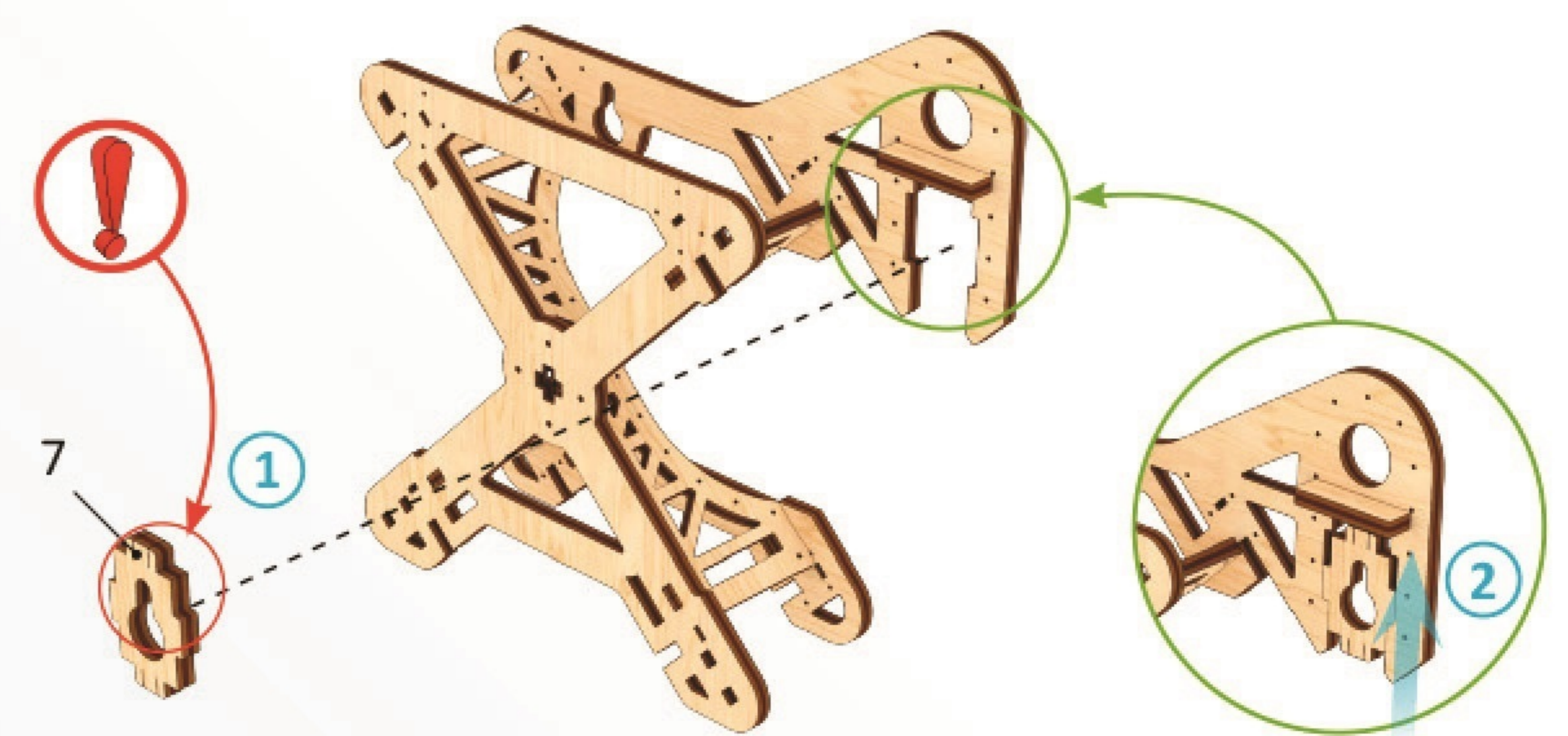

4



Opgelet! Controleer de goede positie.



Schuur om de bramen te verwijderen.

6

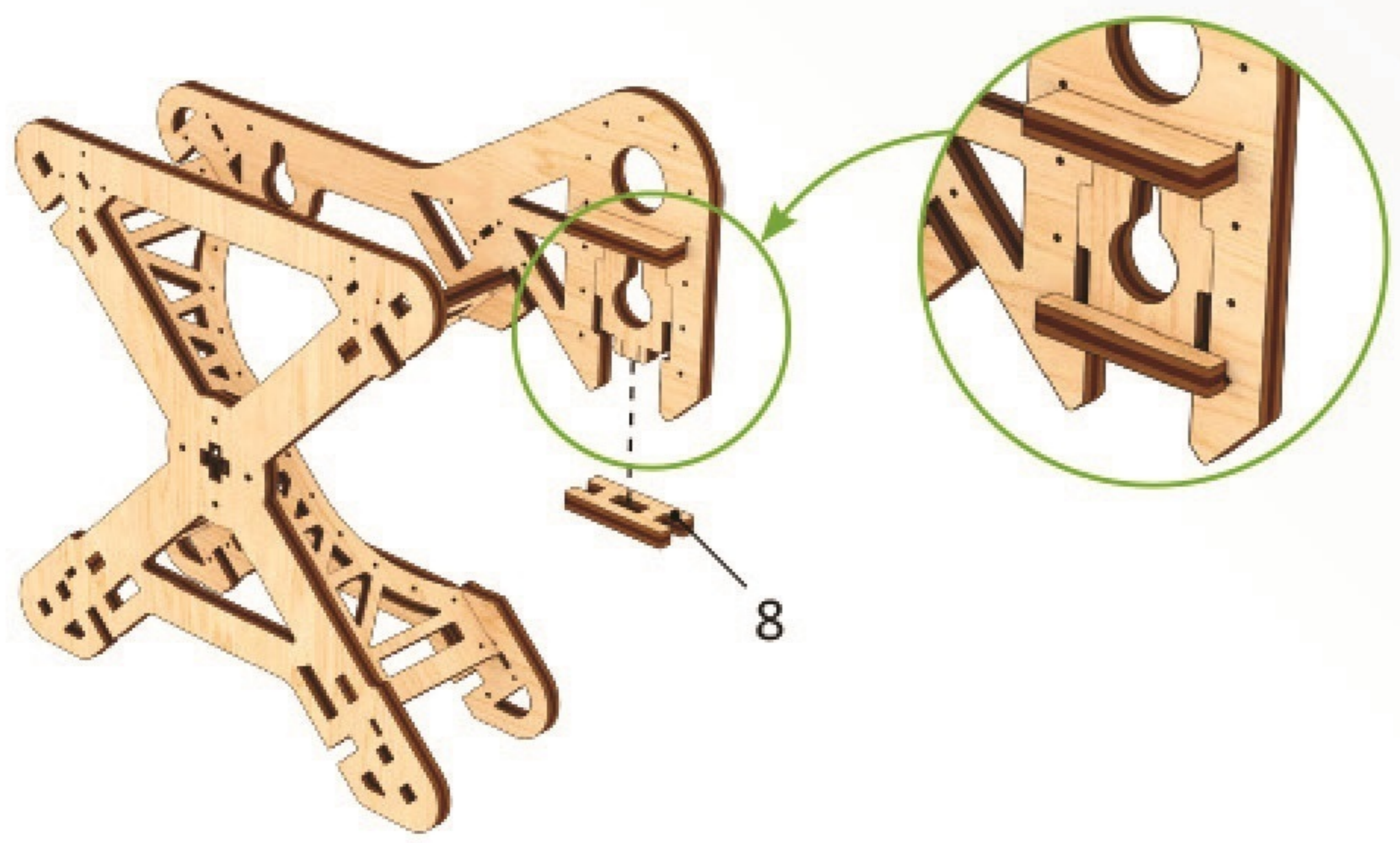

7

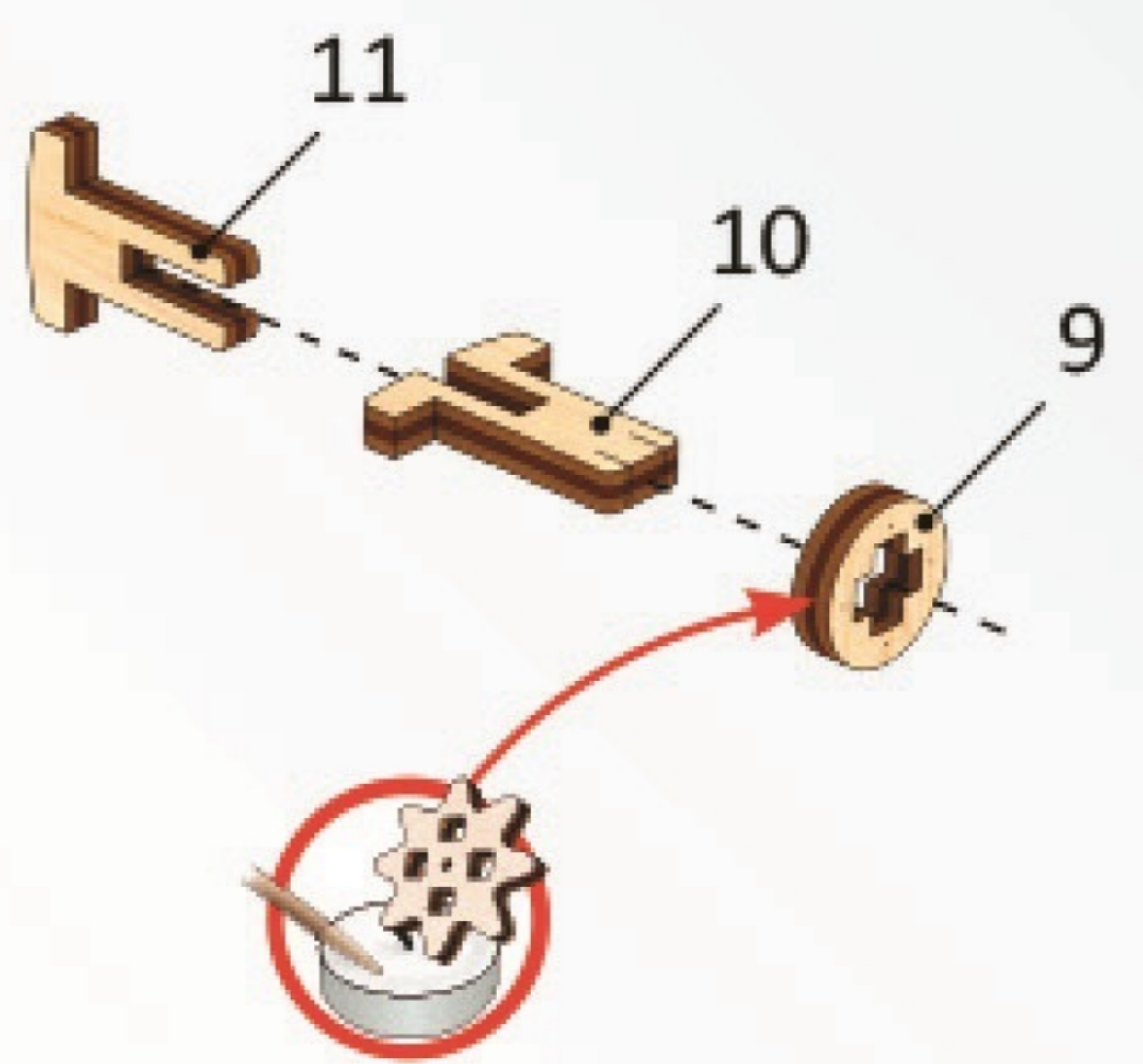

8

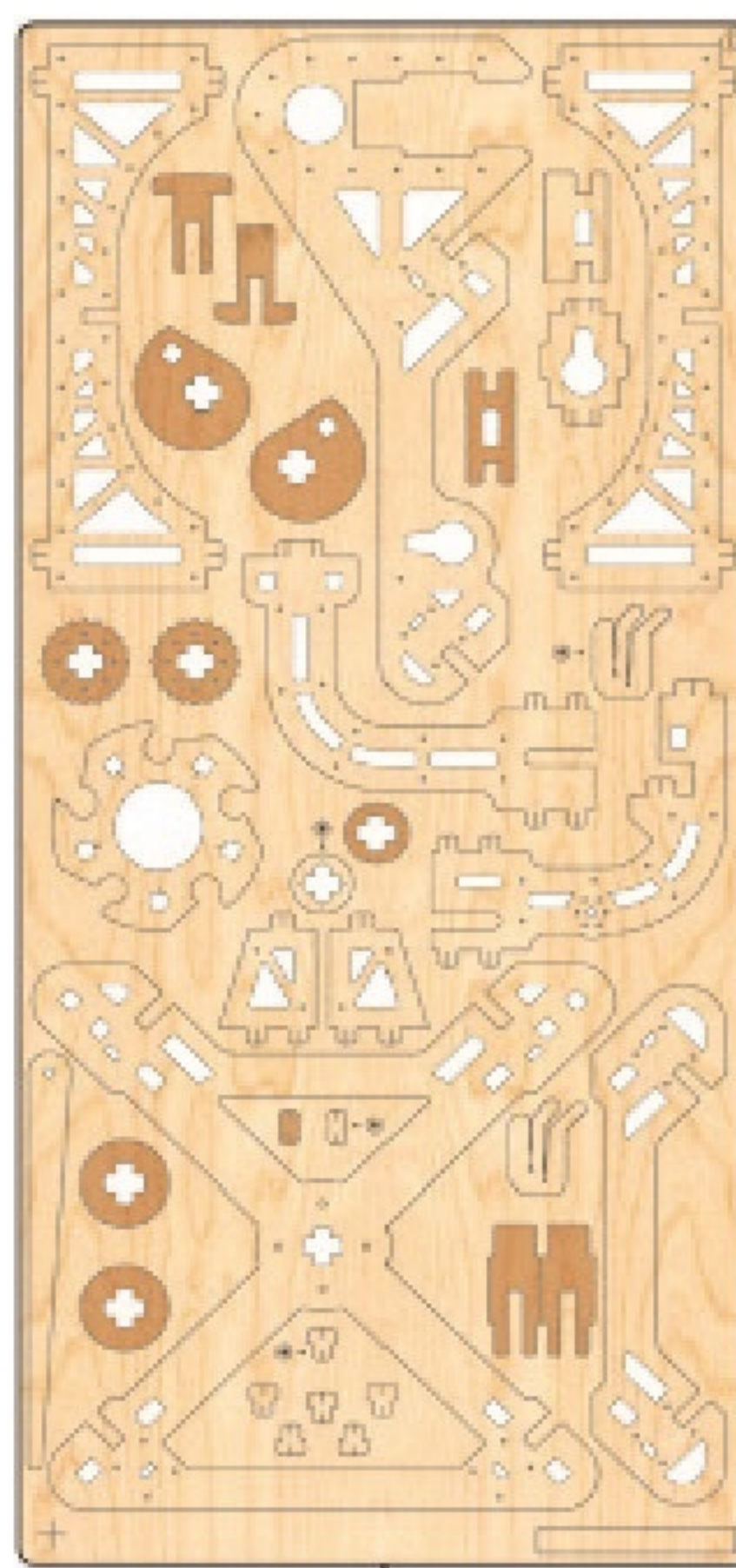
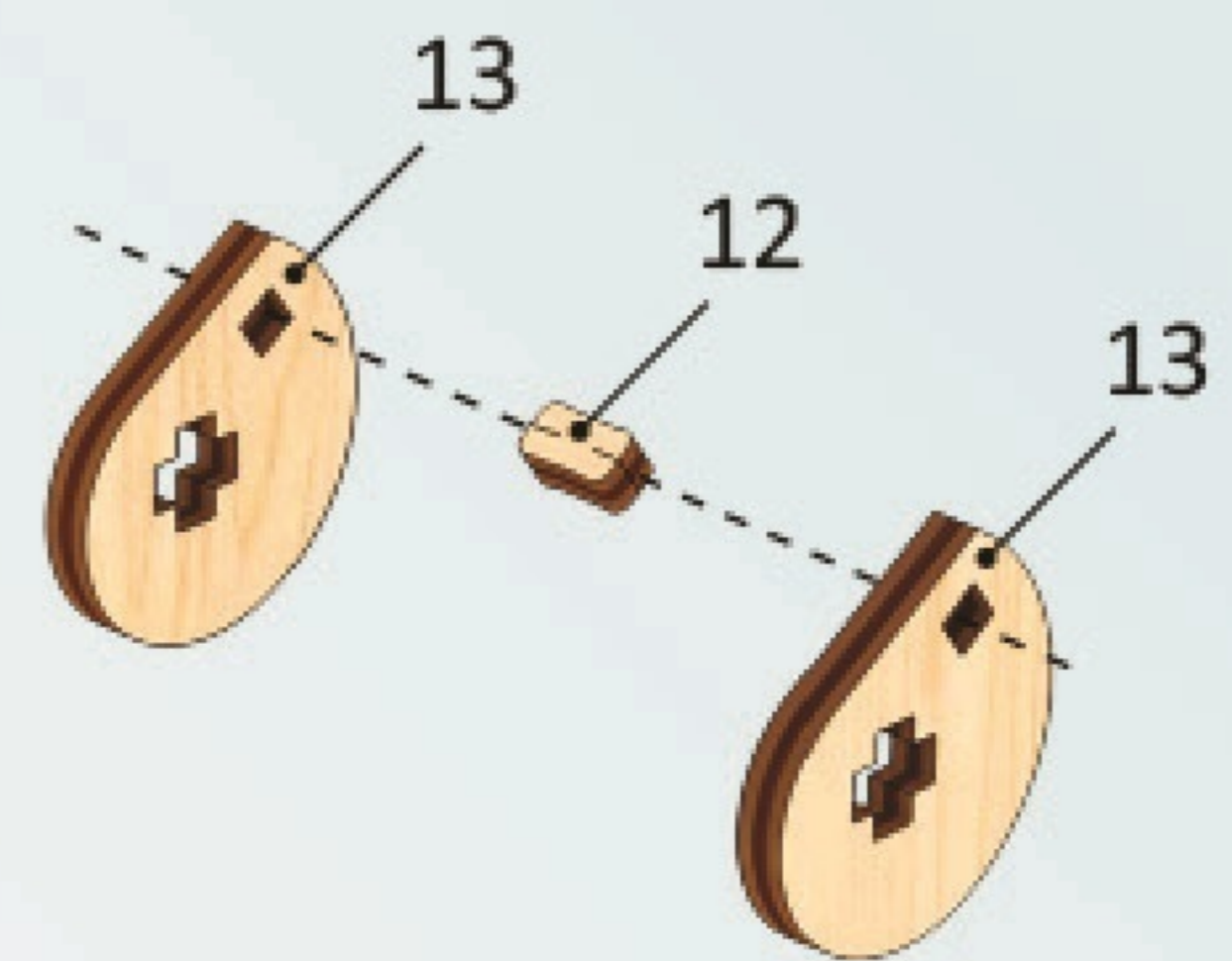

①

9

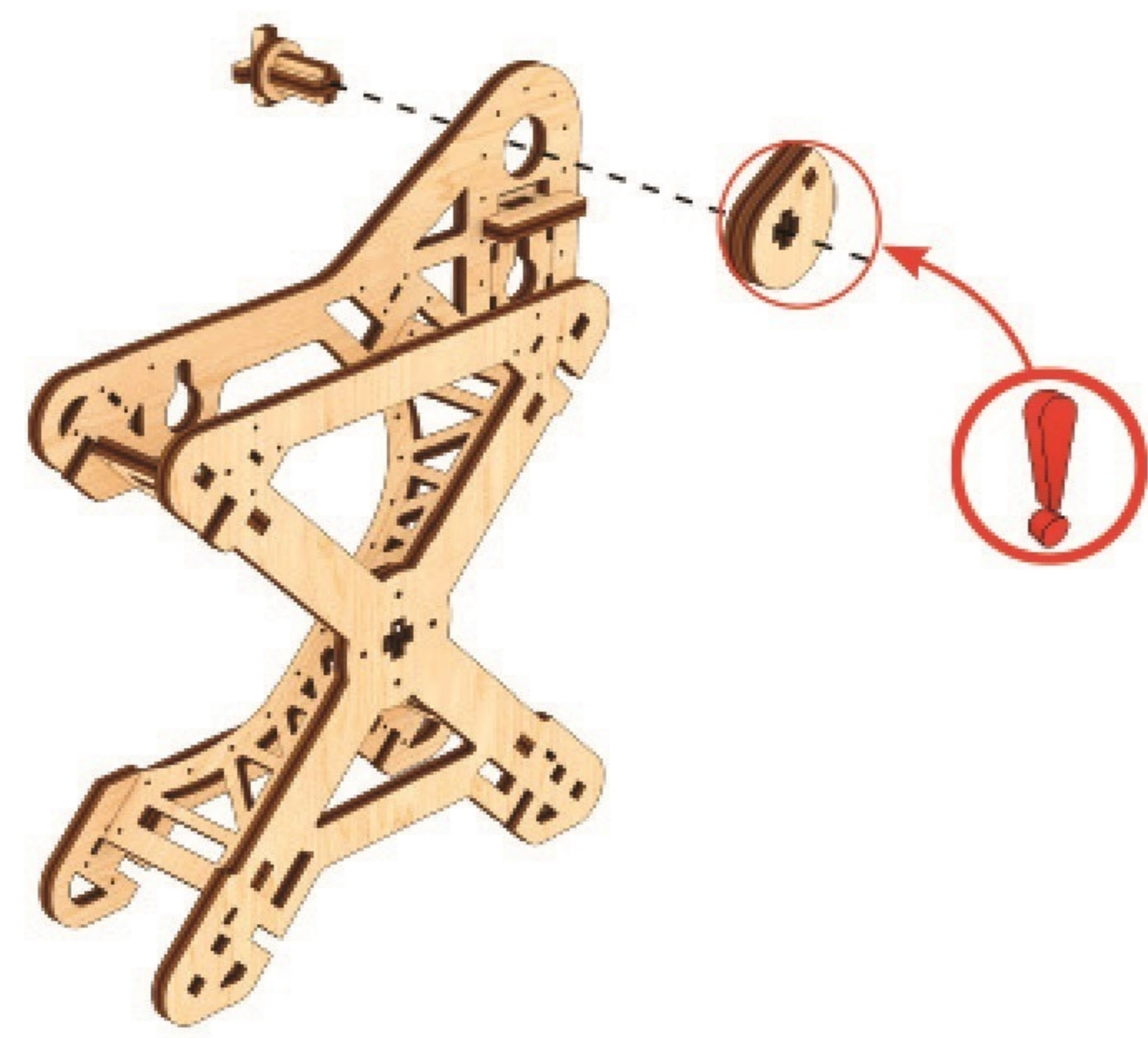

10

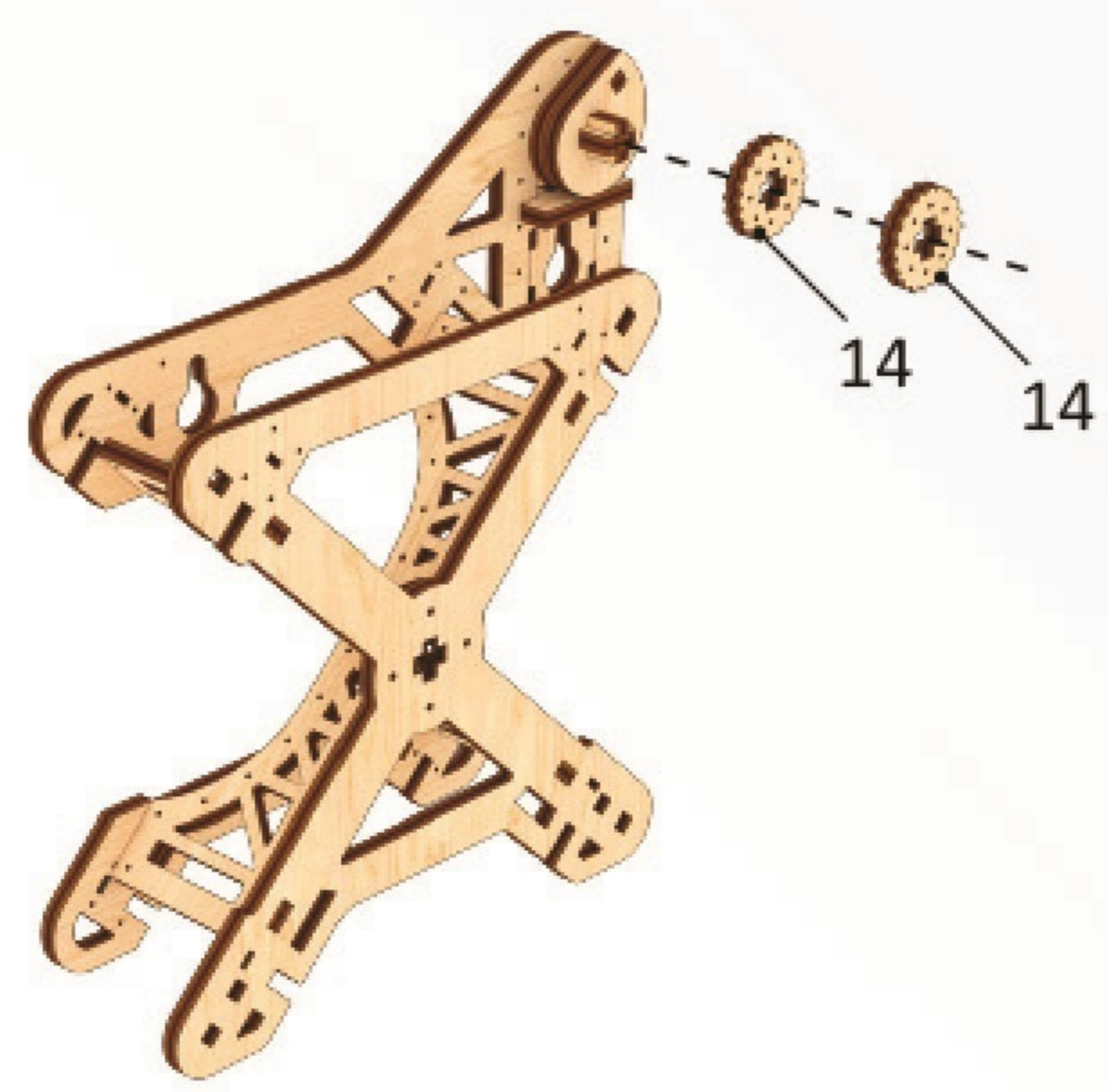

11

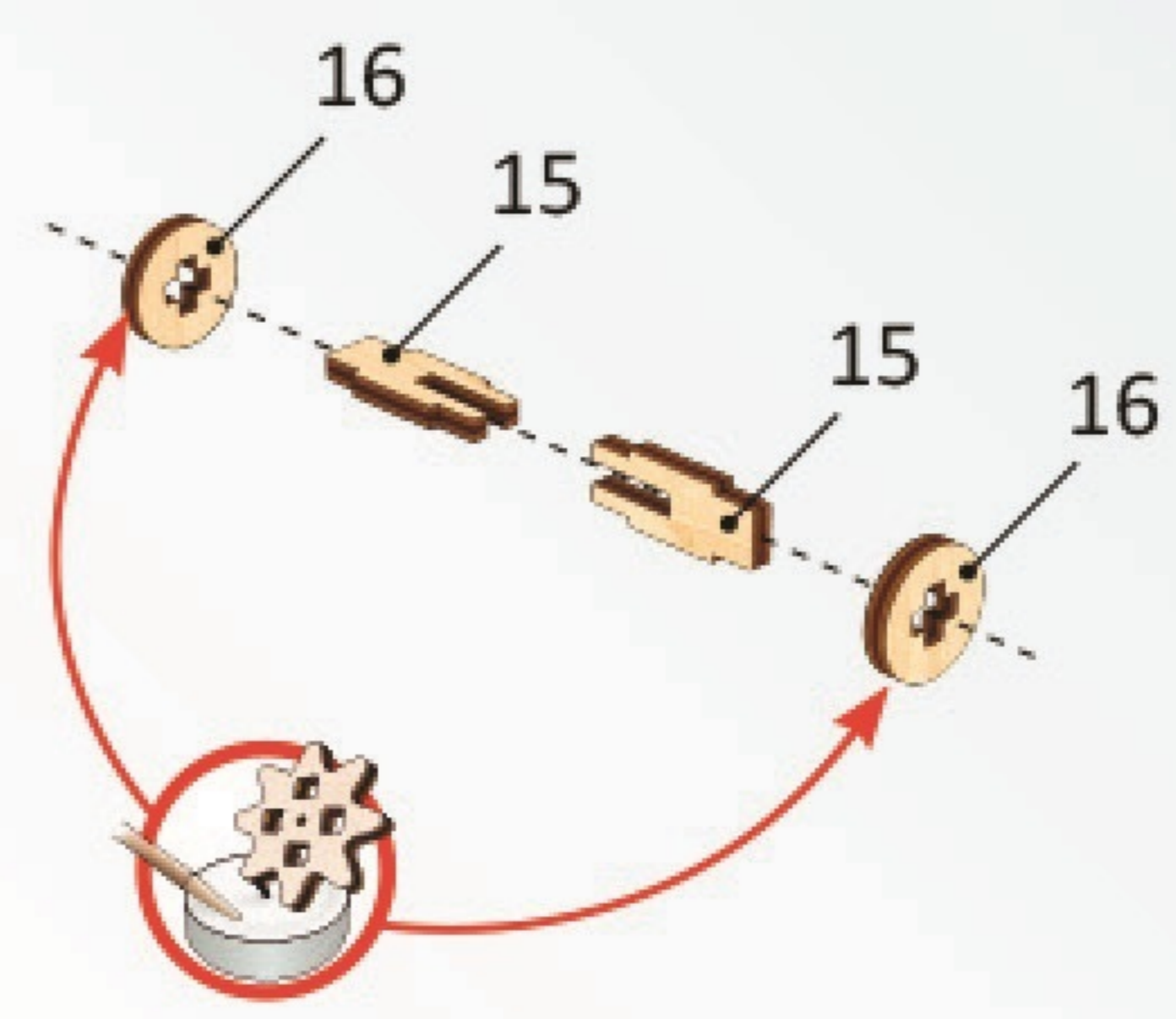

12

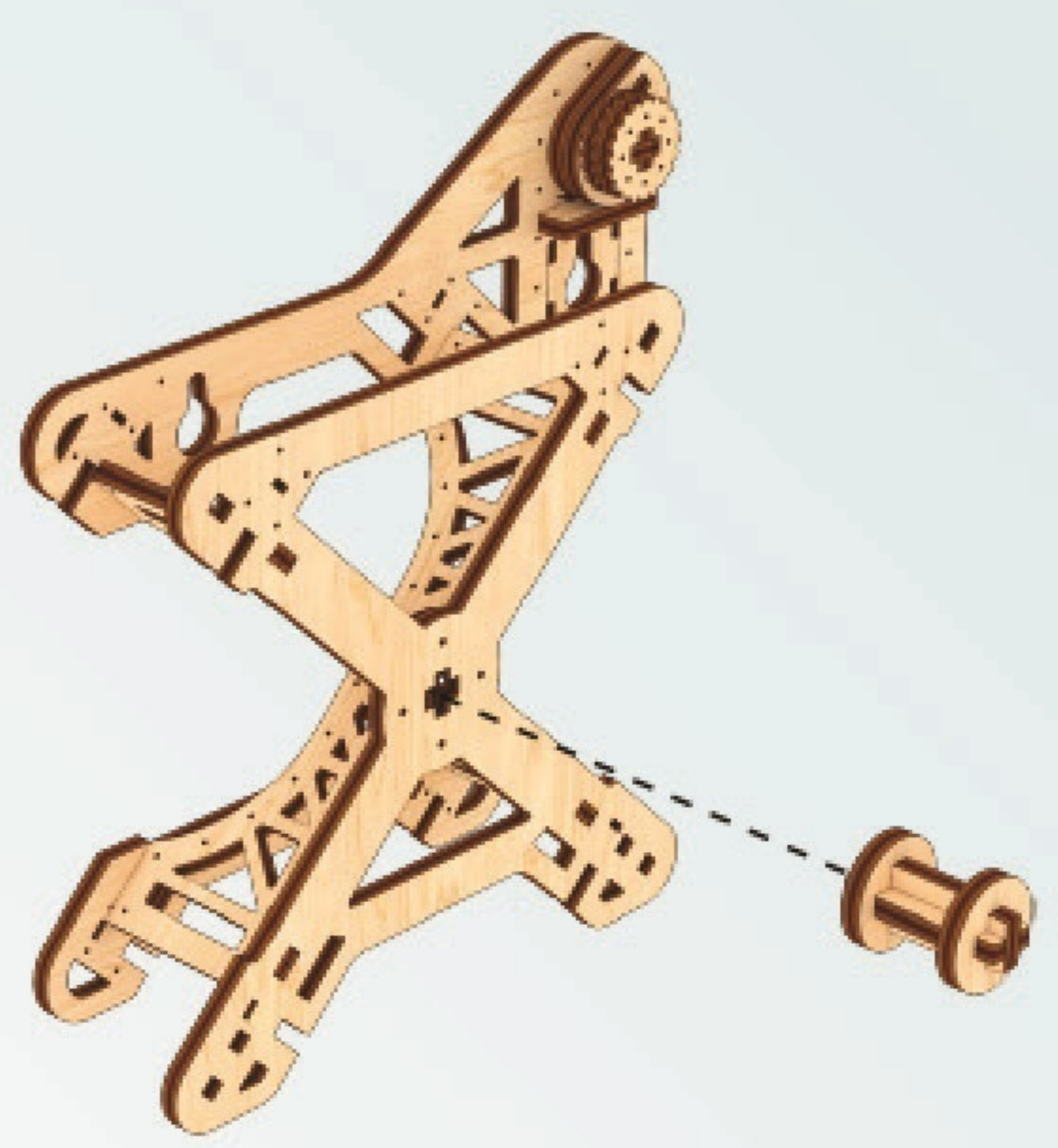

Smeer het onderdeel in met kaarsvet.

5

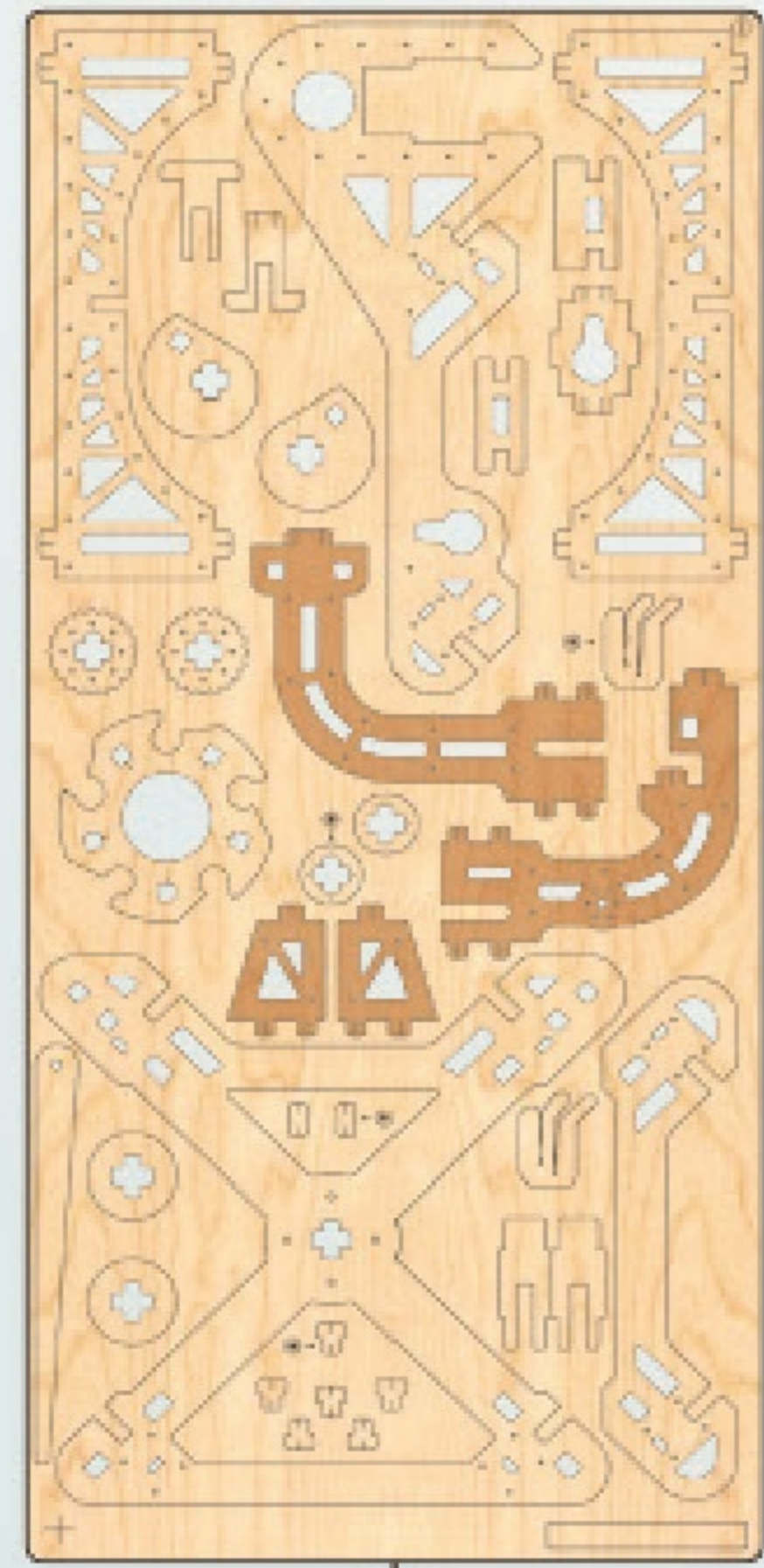

①

13

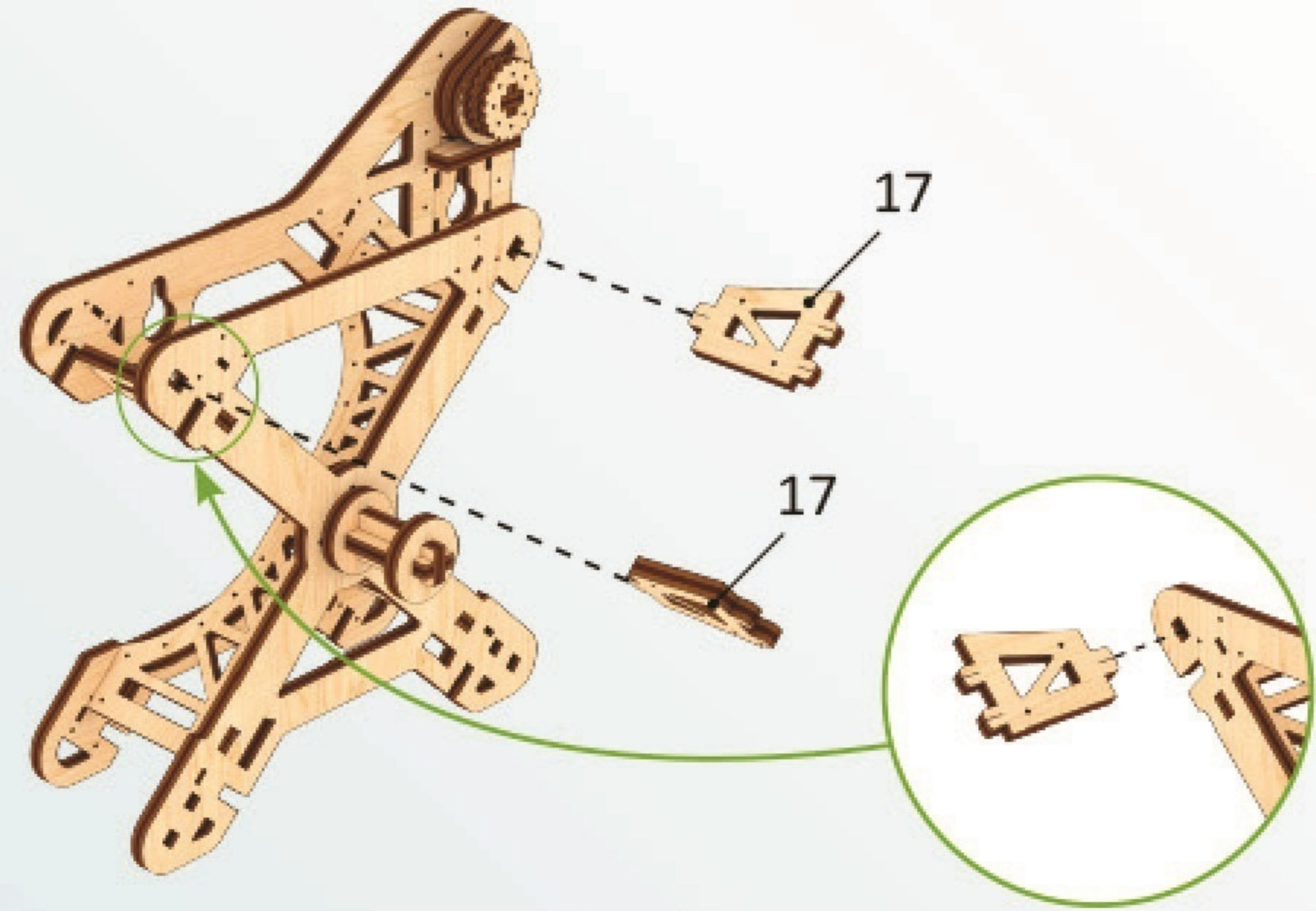

14

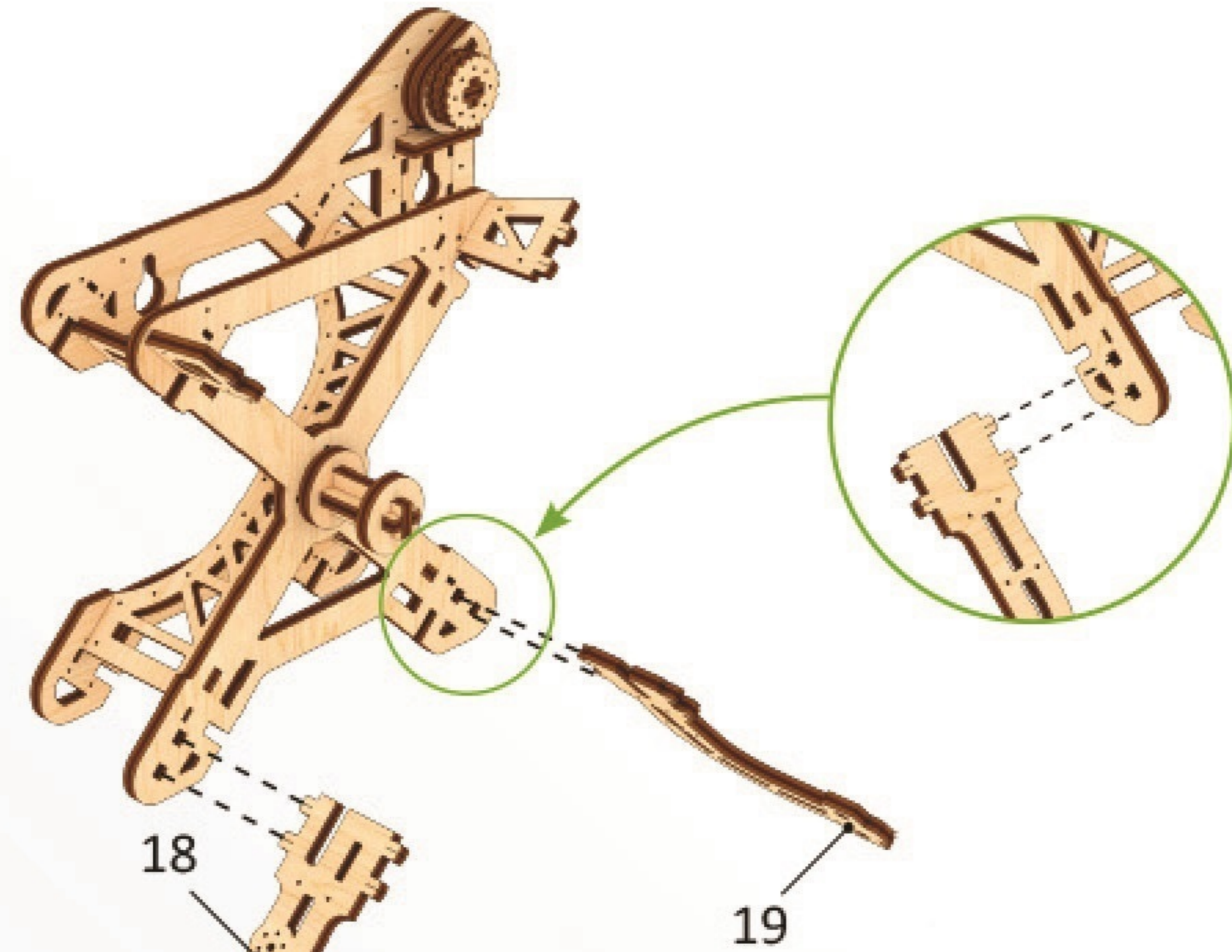

a1

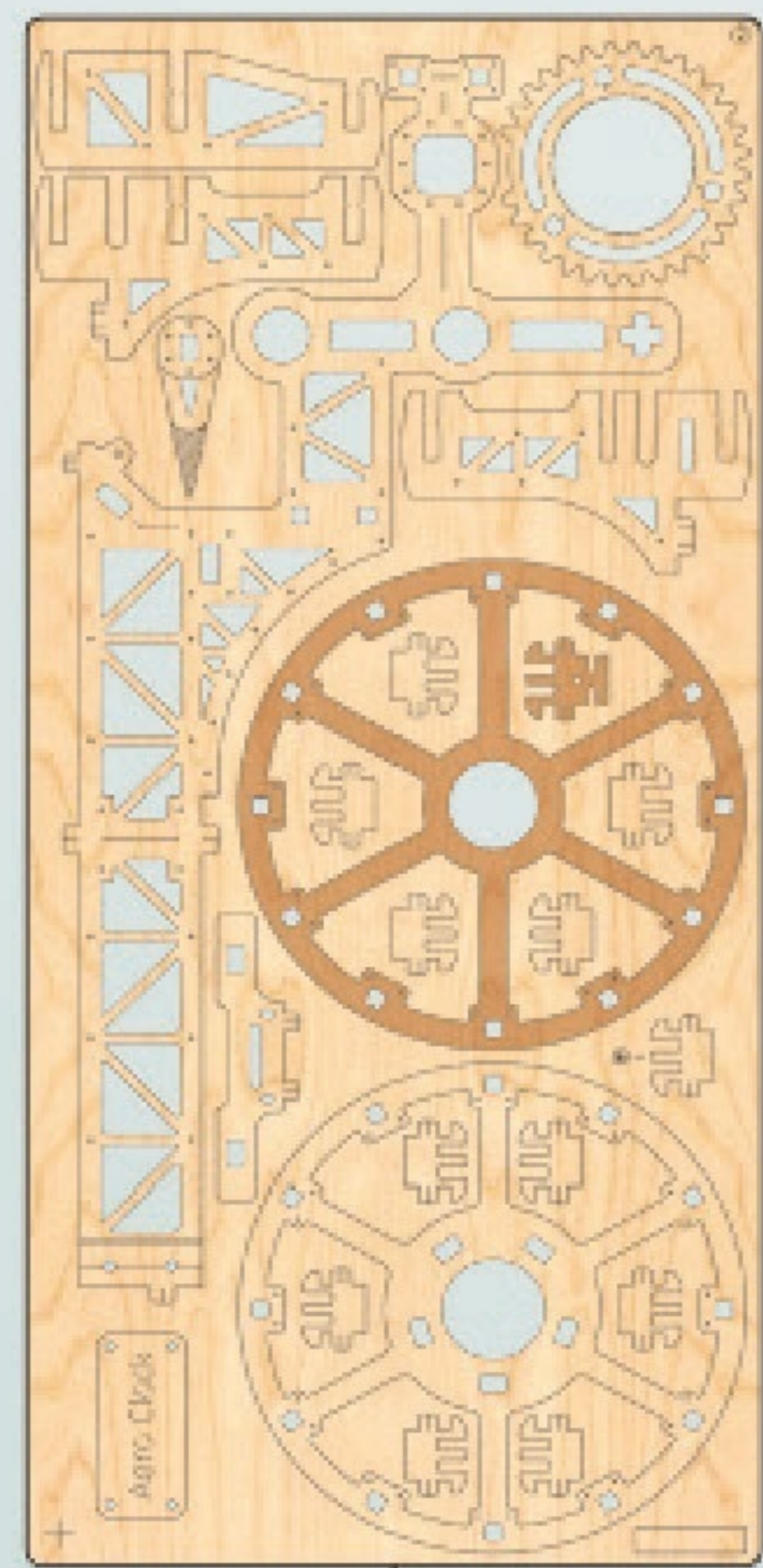
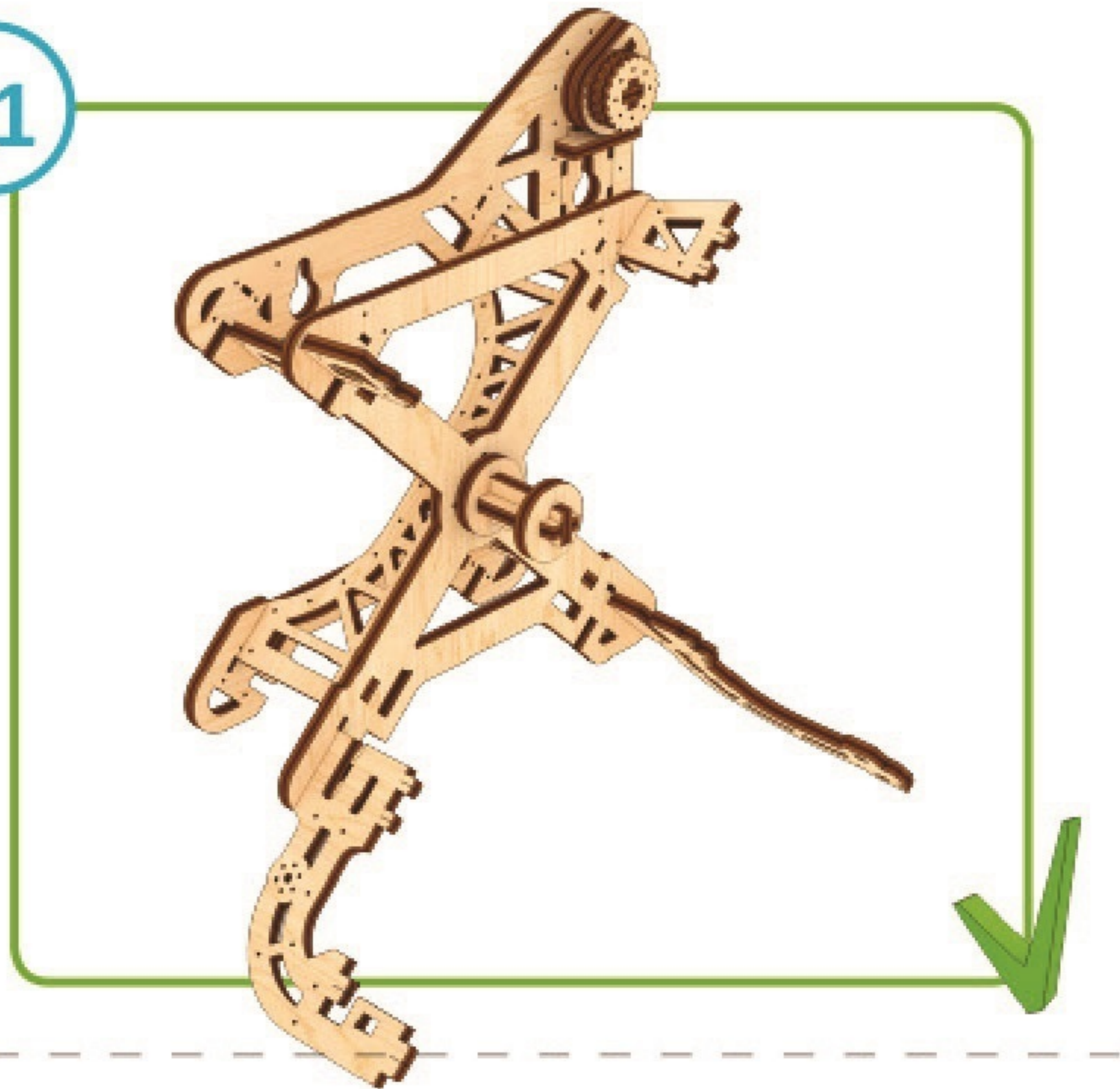

②

1

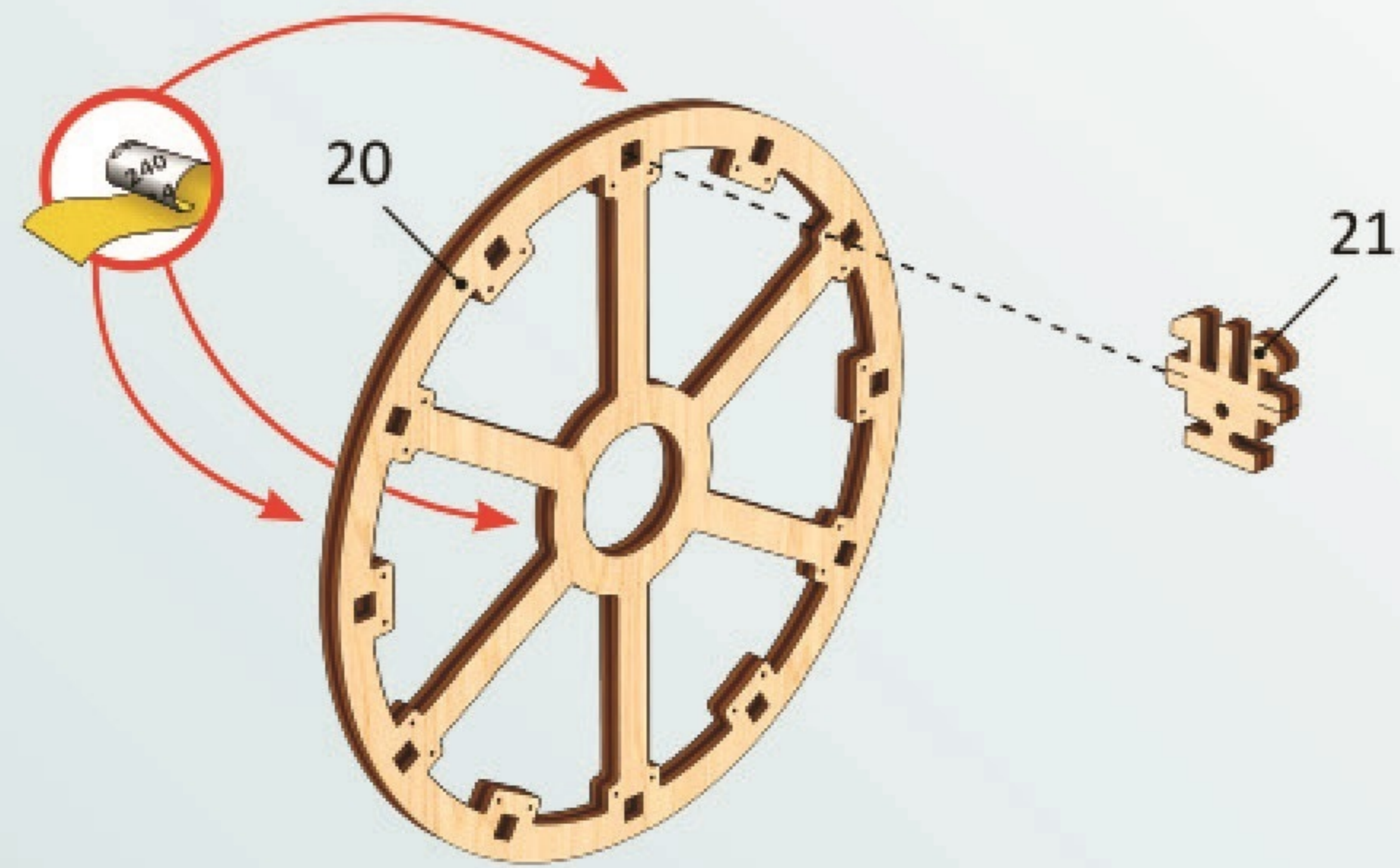

2



6



Controleer grootte.

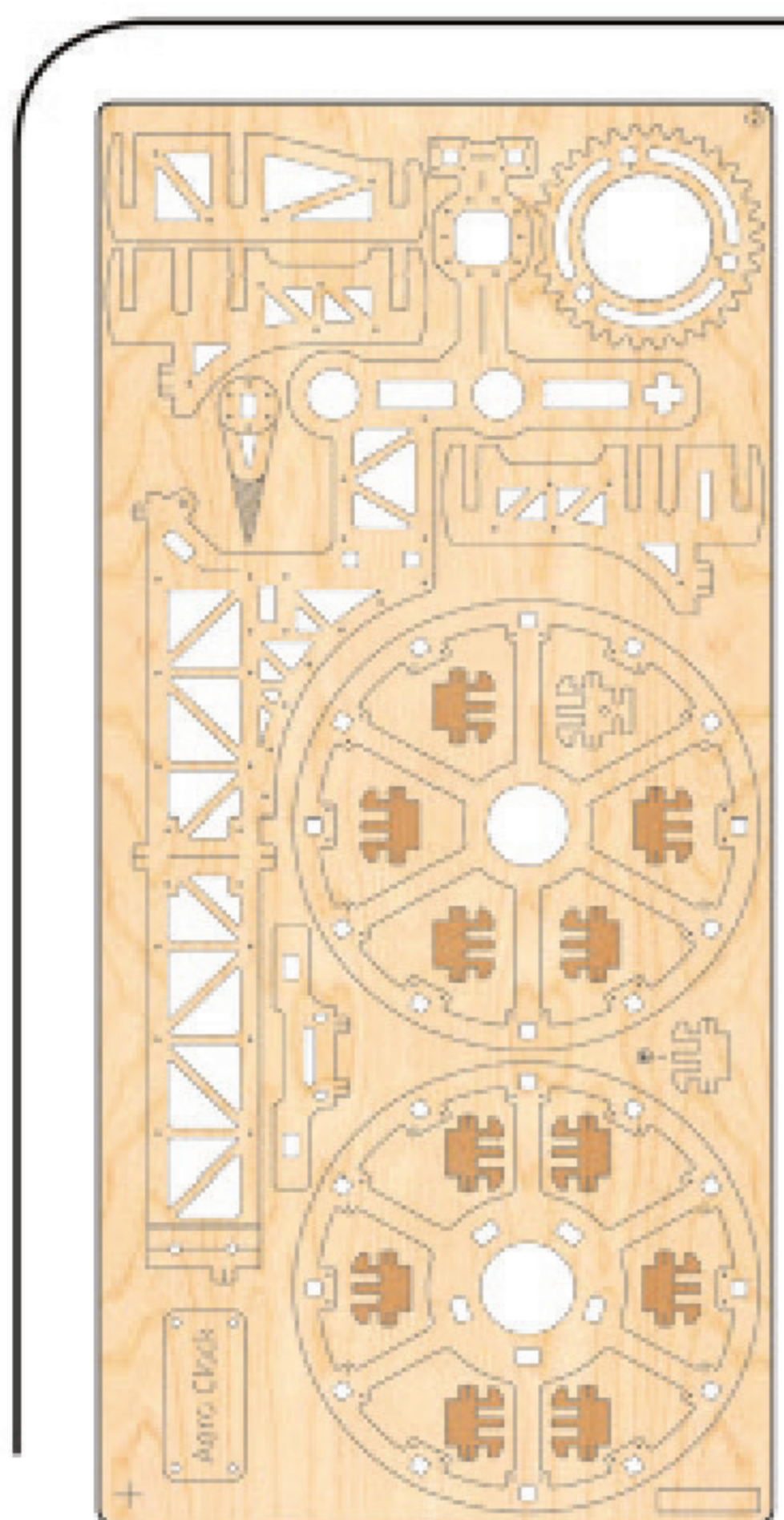

3

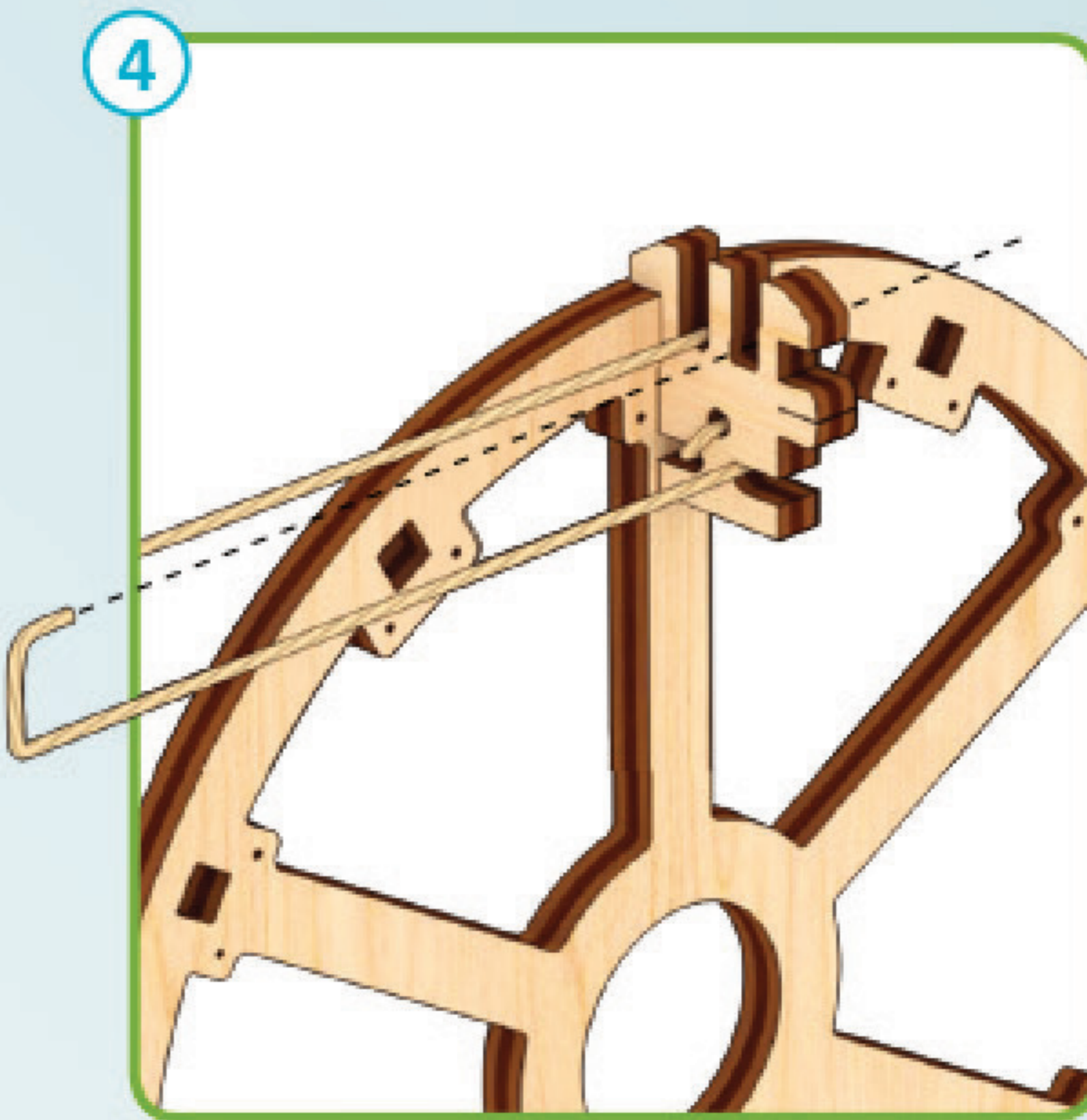
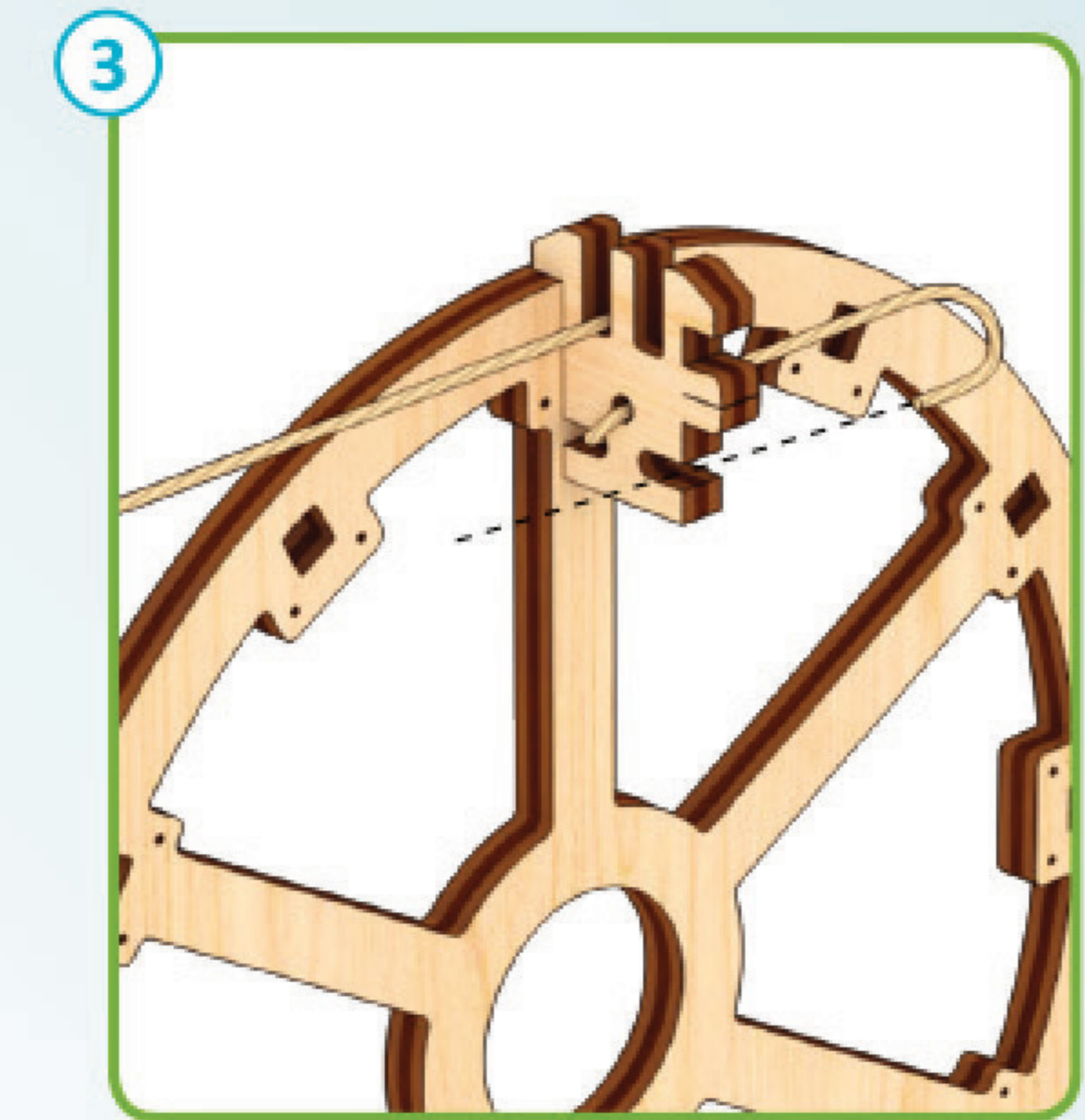
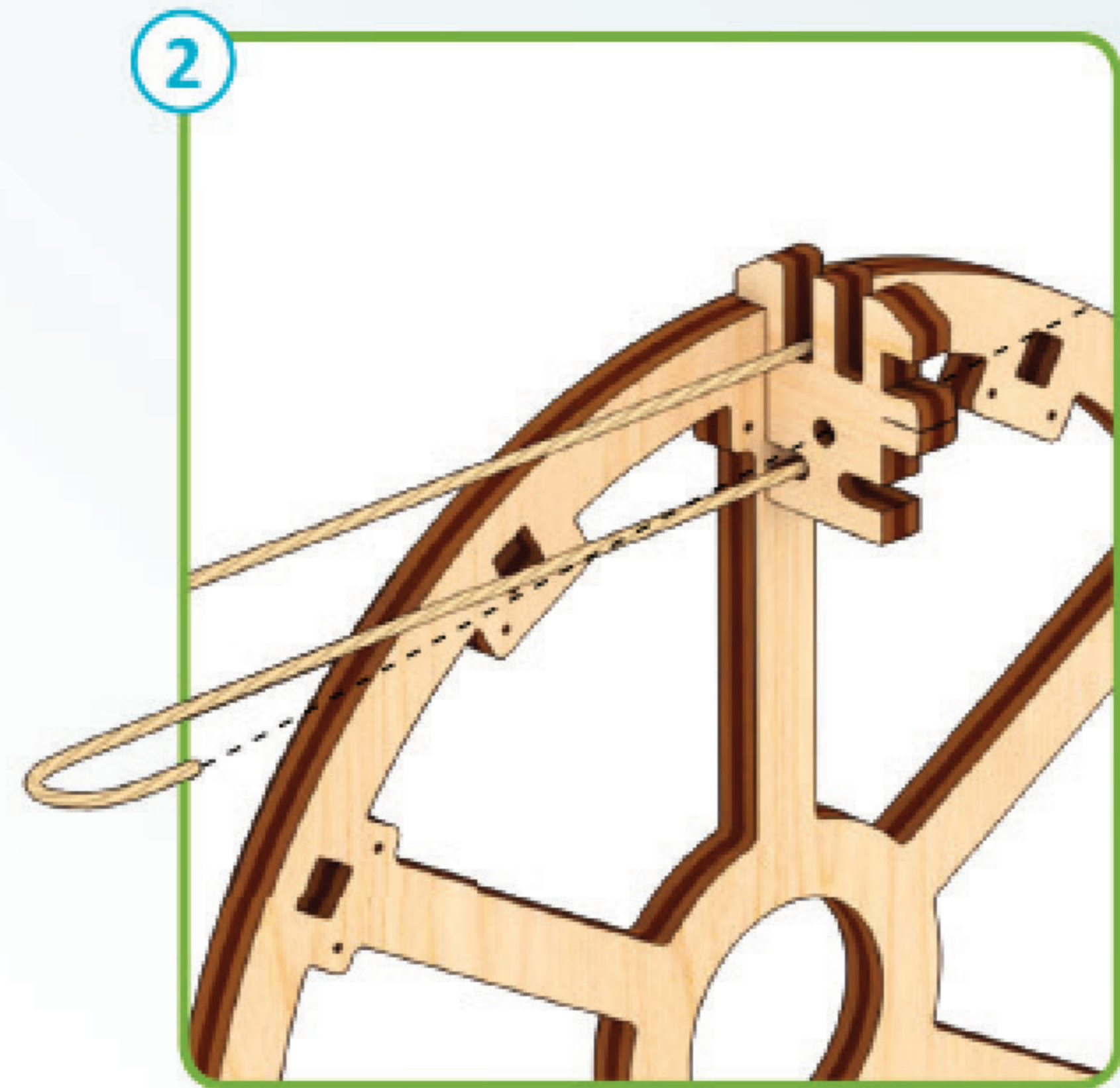
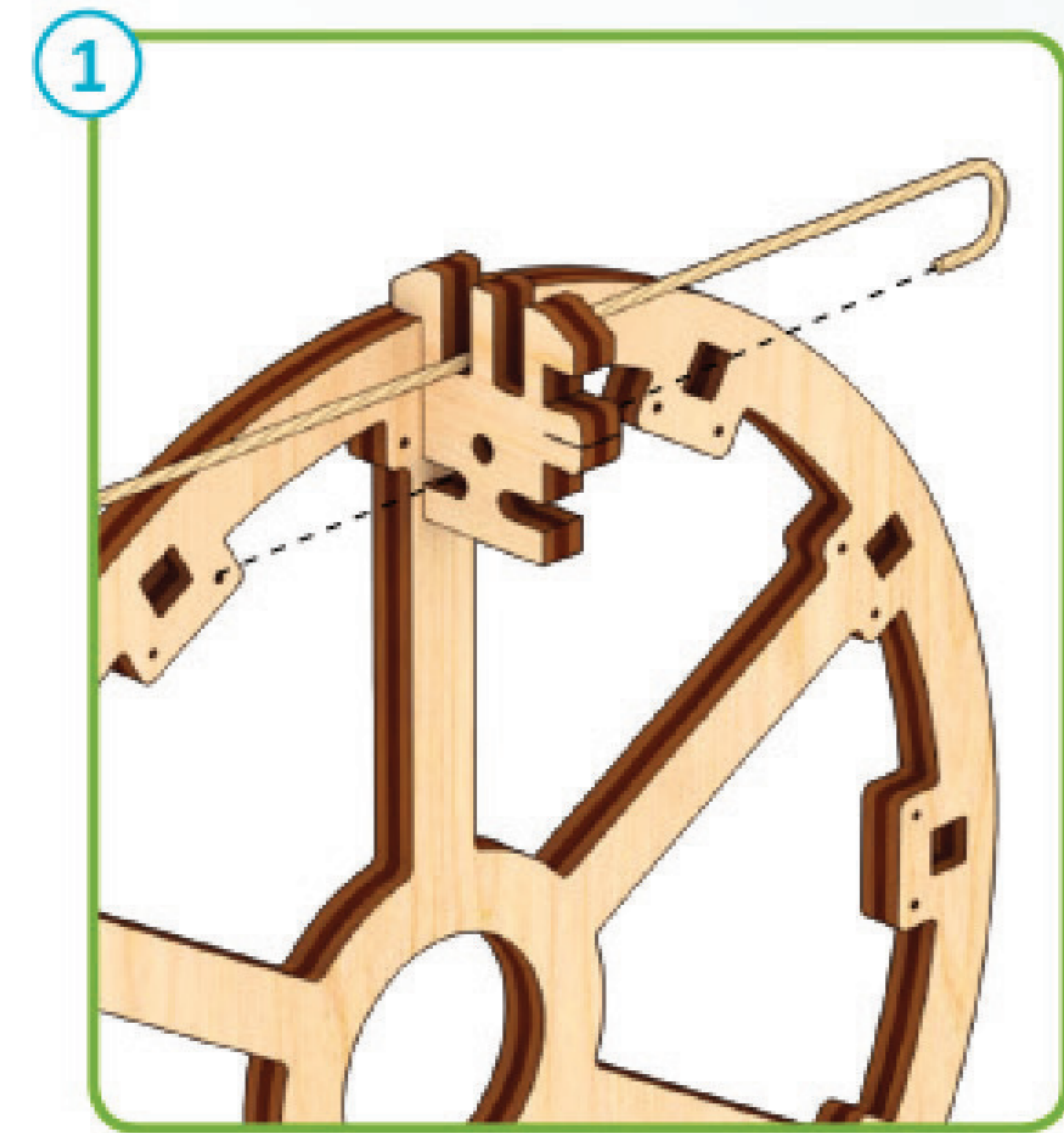

4

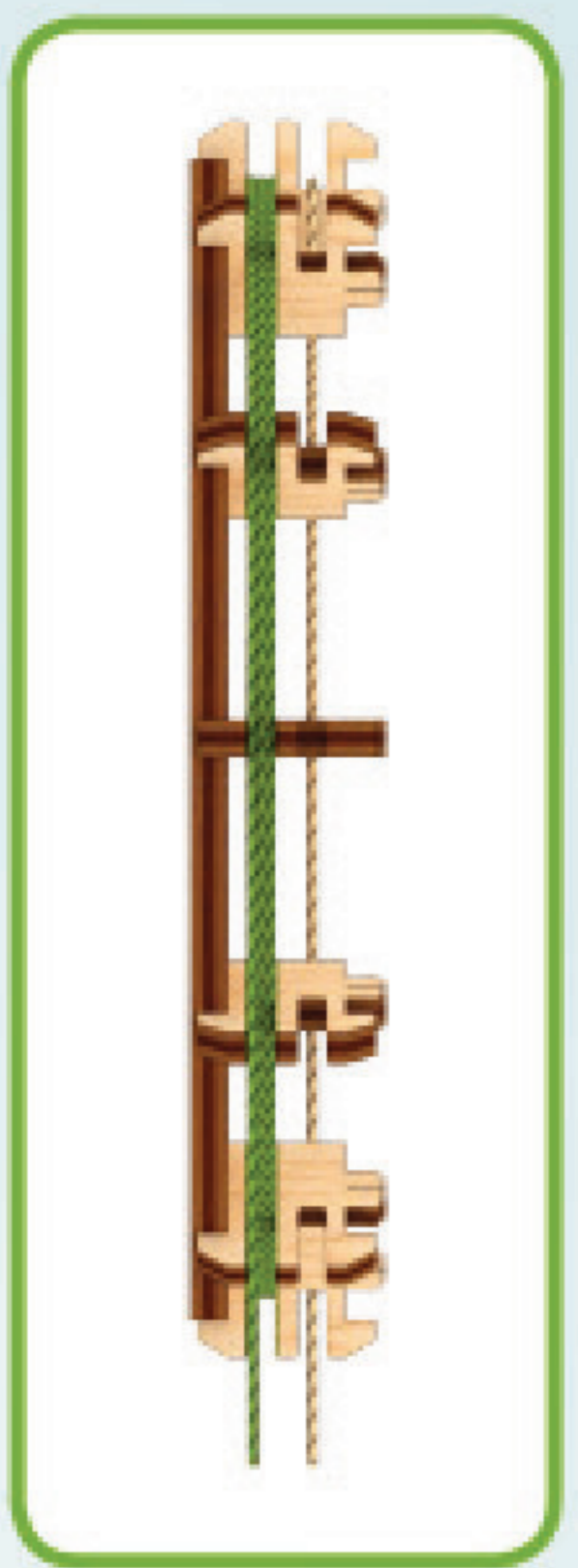
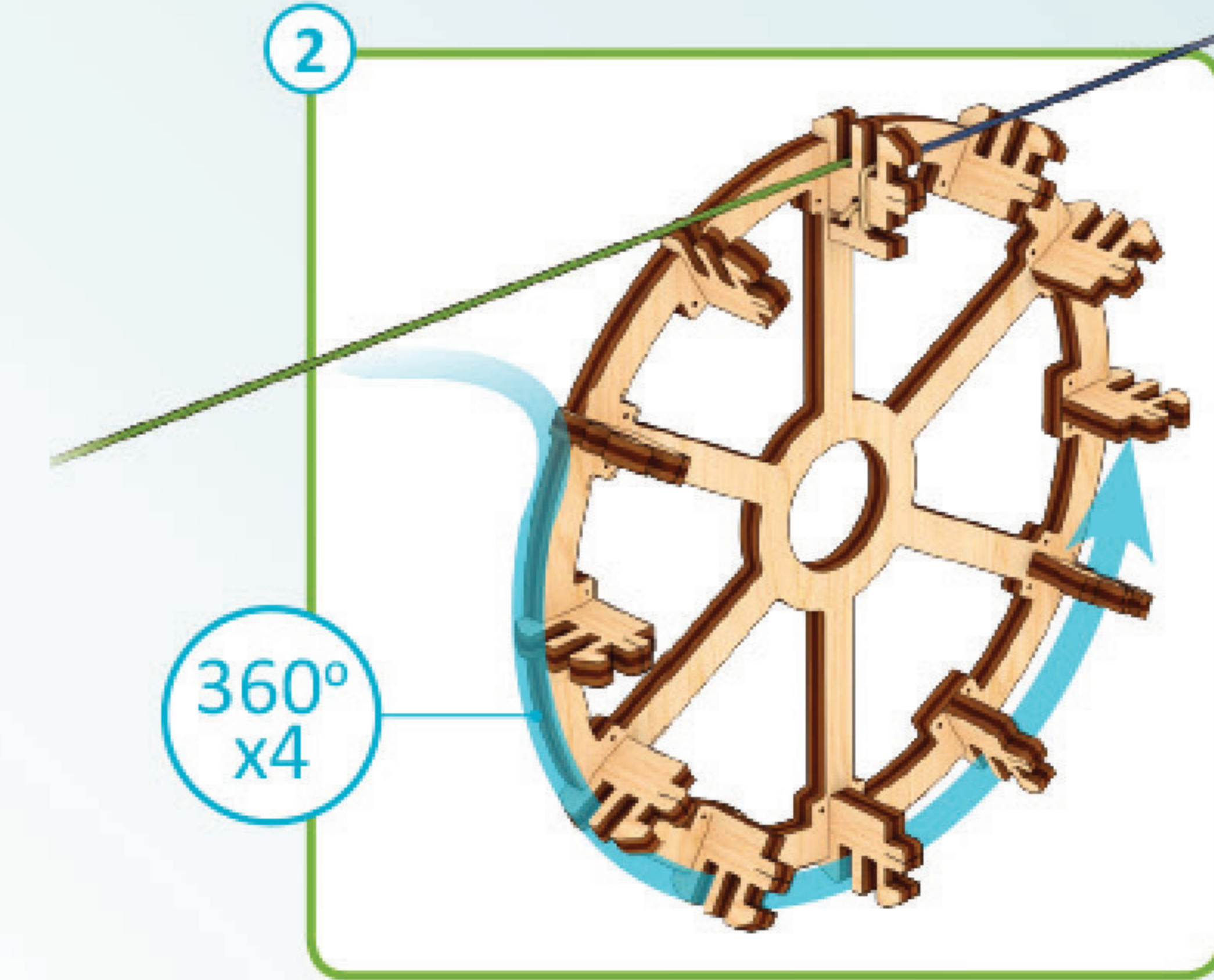
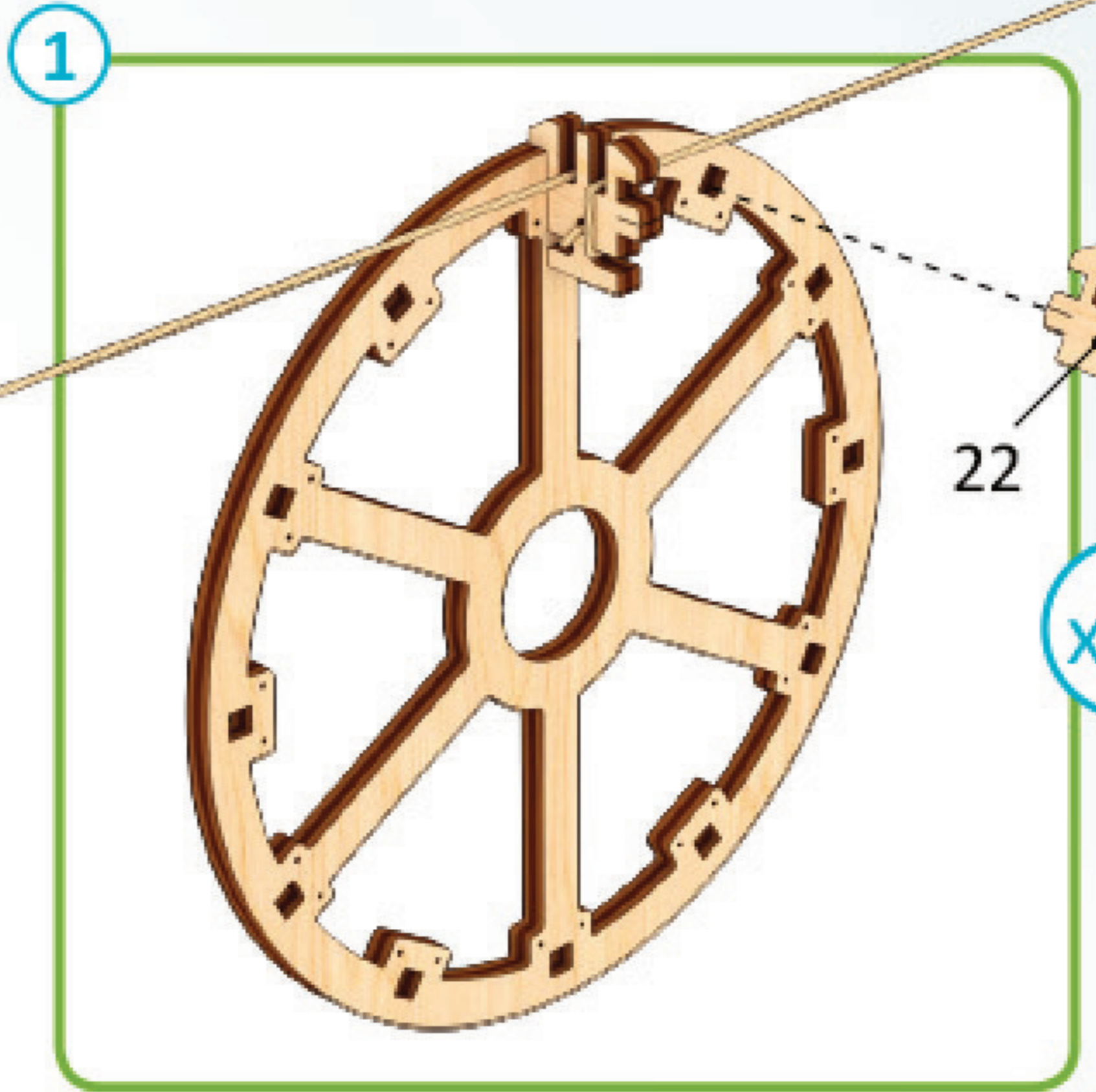
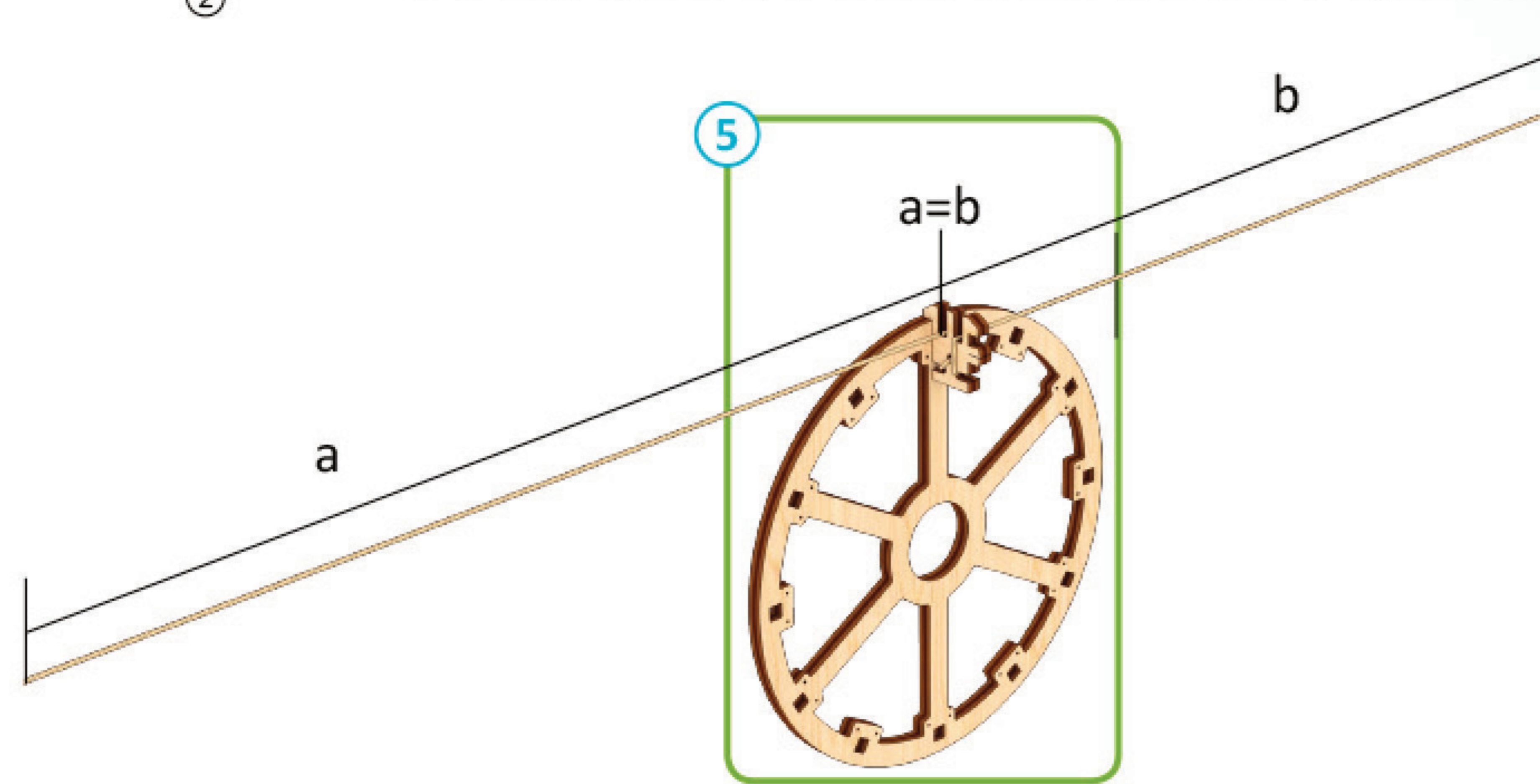

3

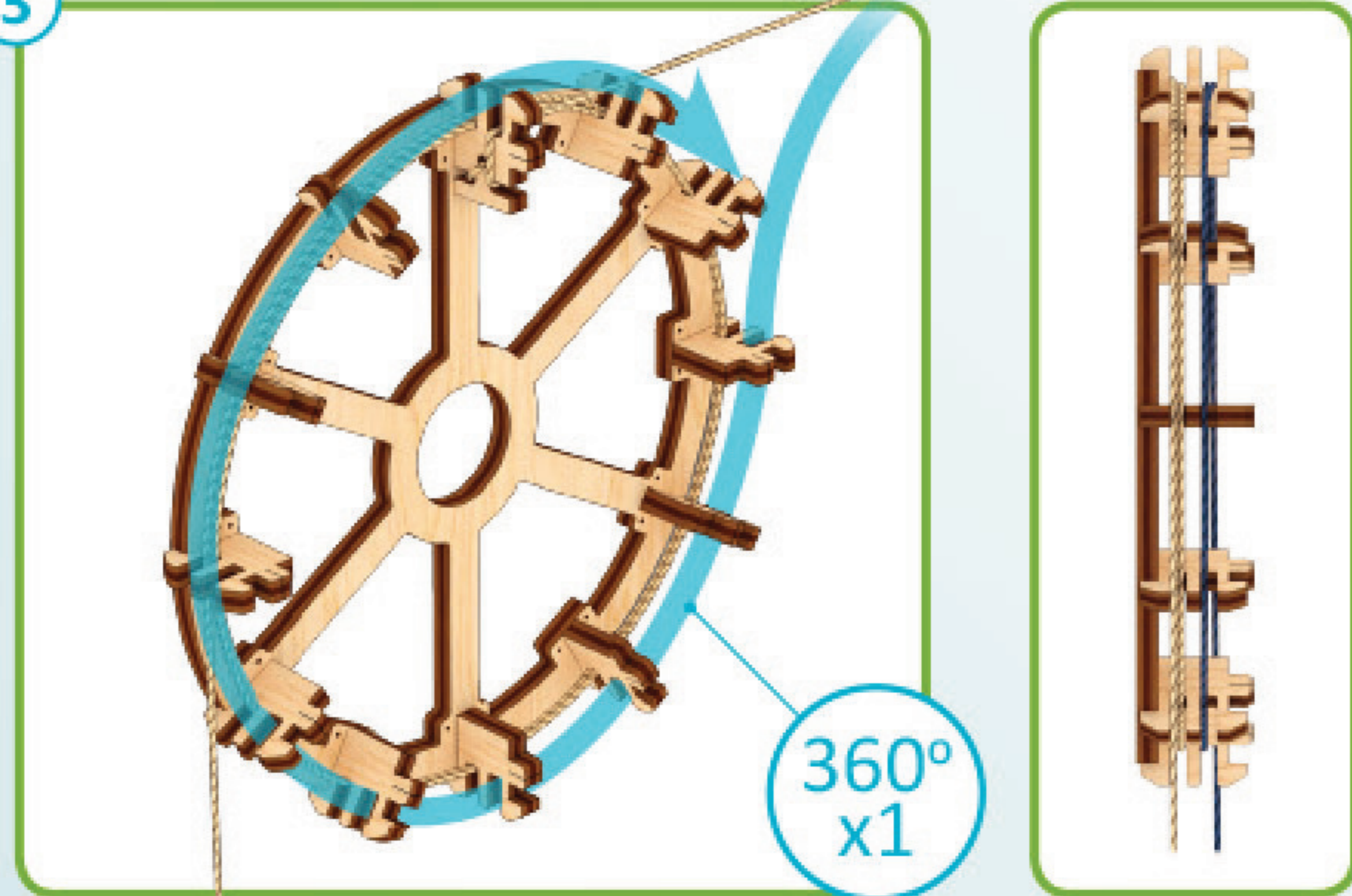

5



6

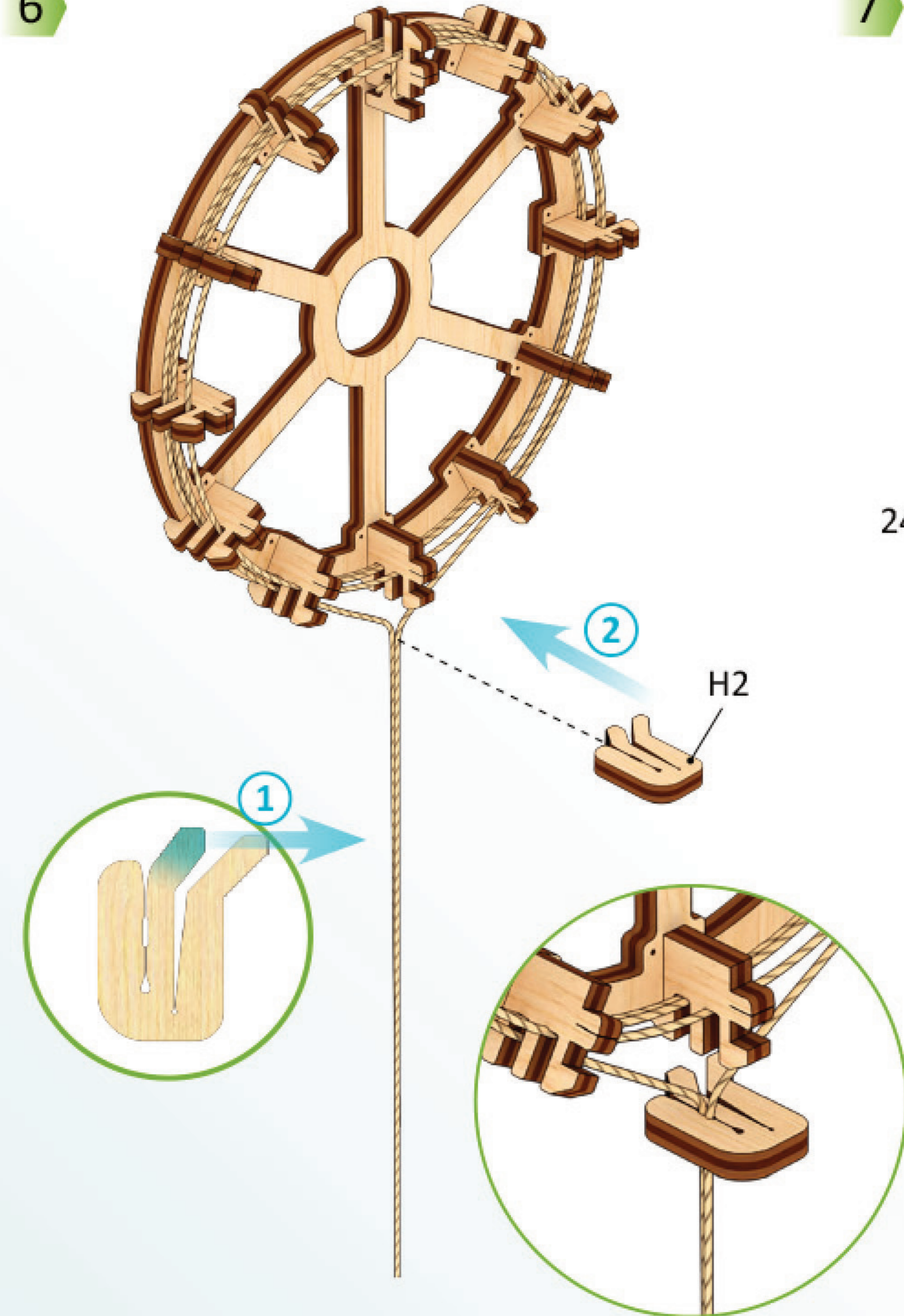

7

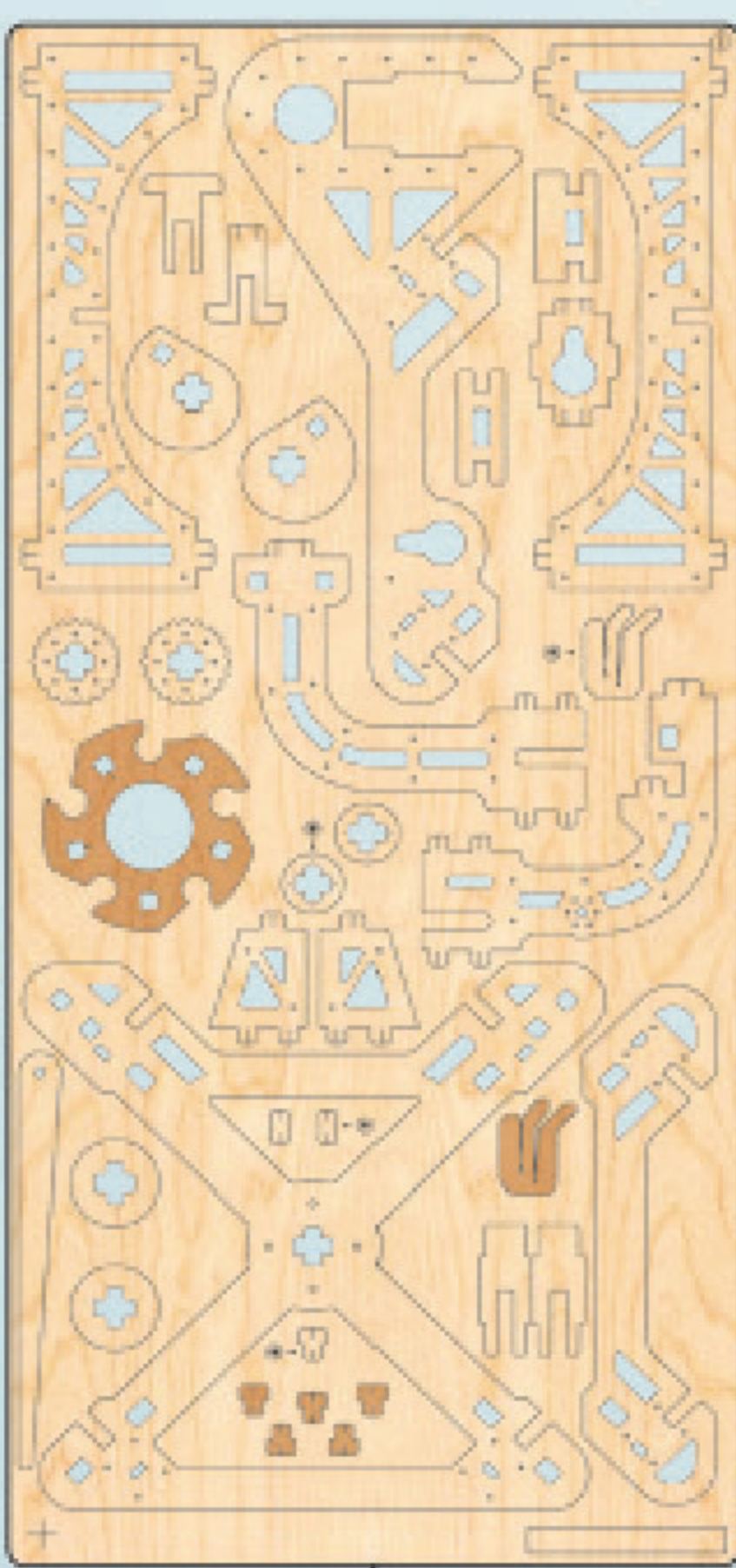
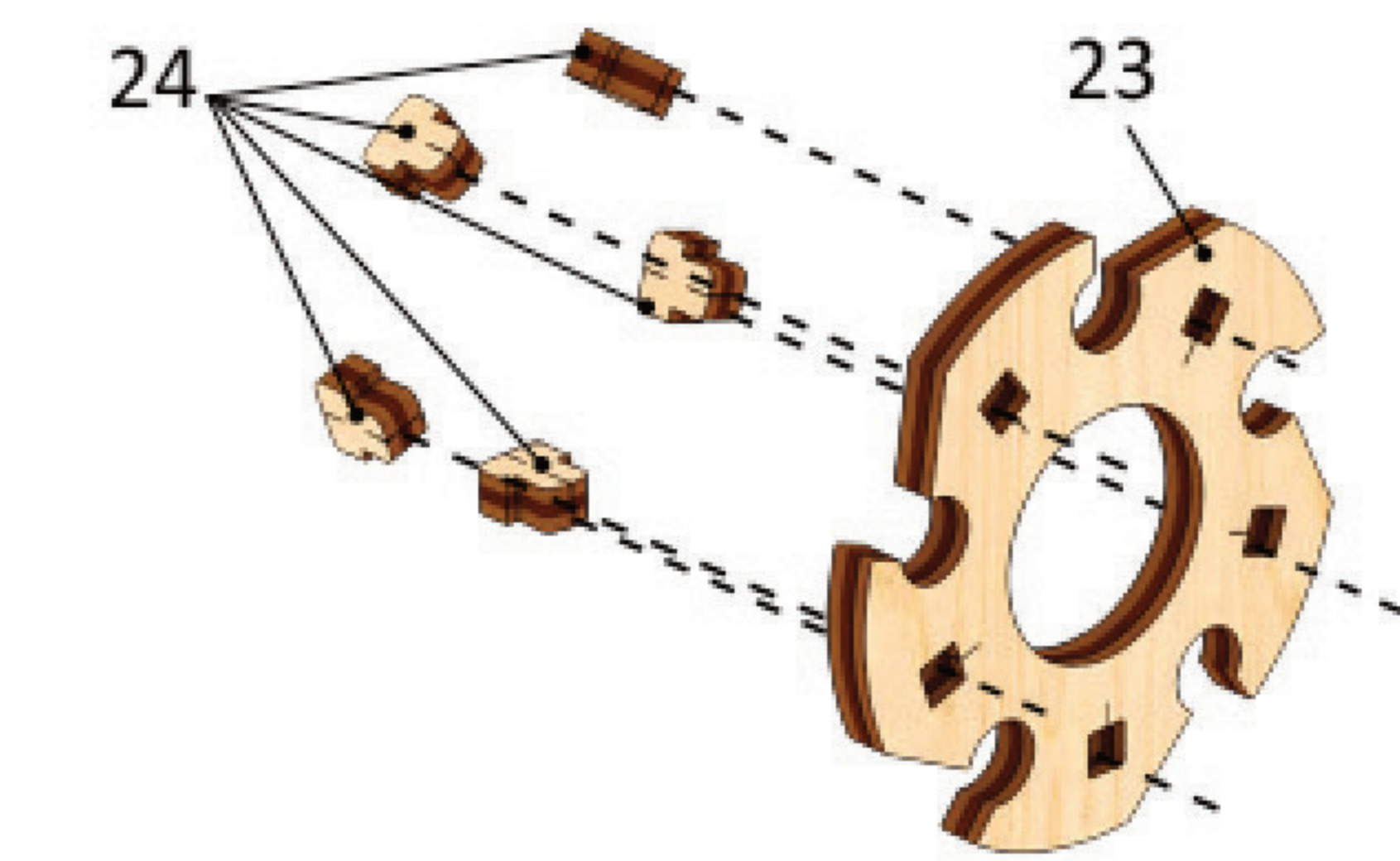

8

1



8

25

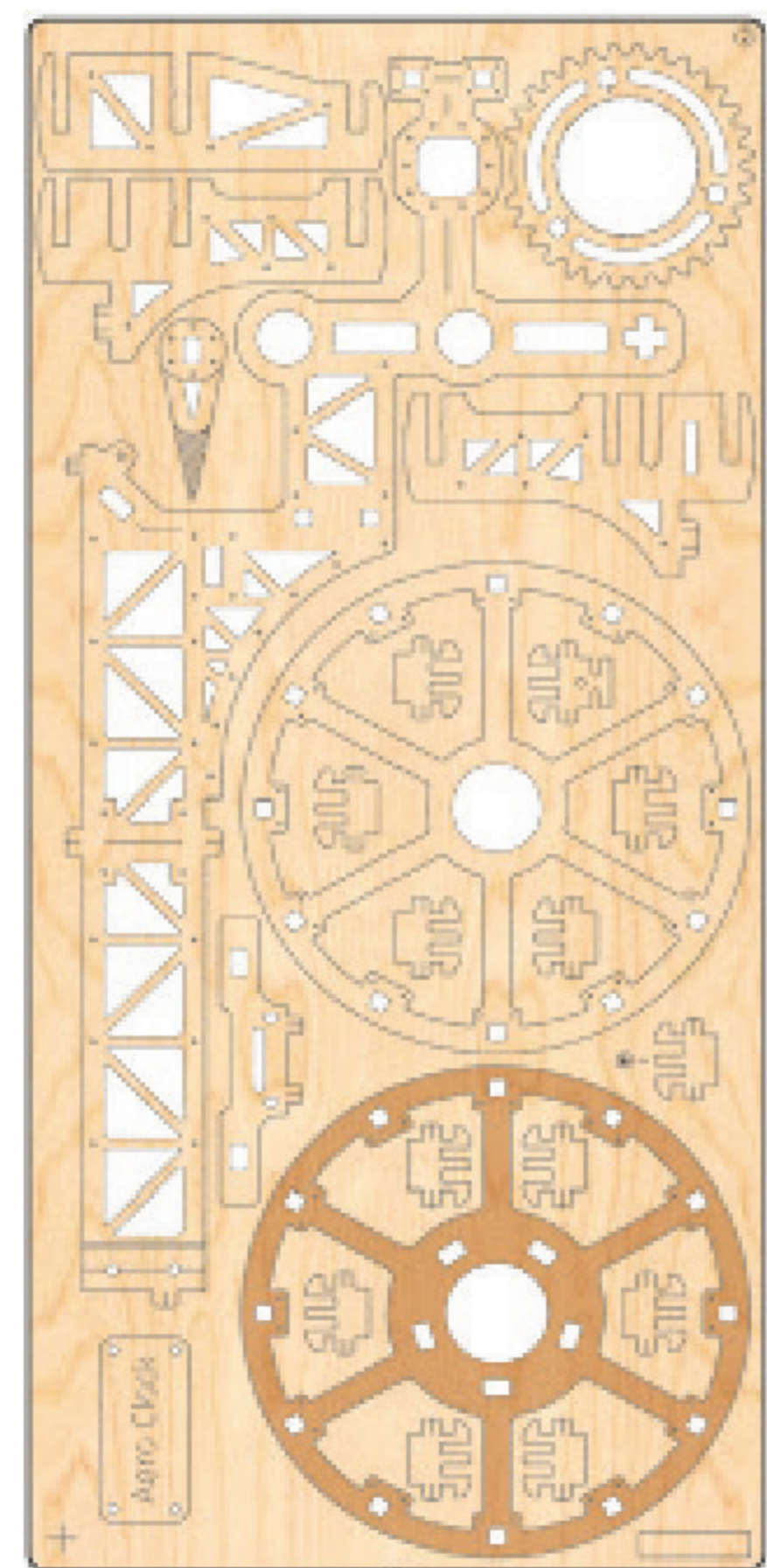
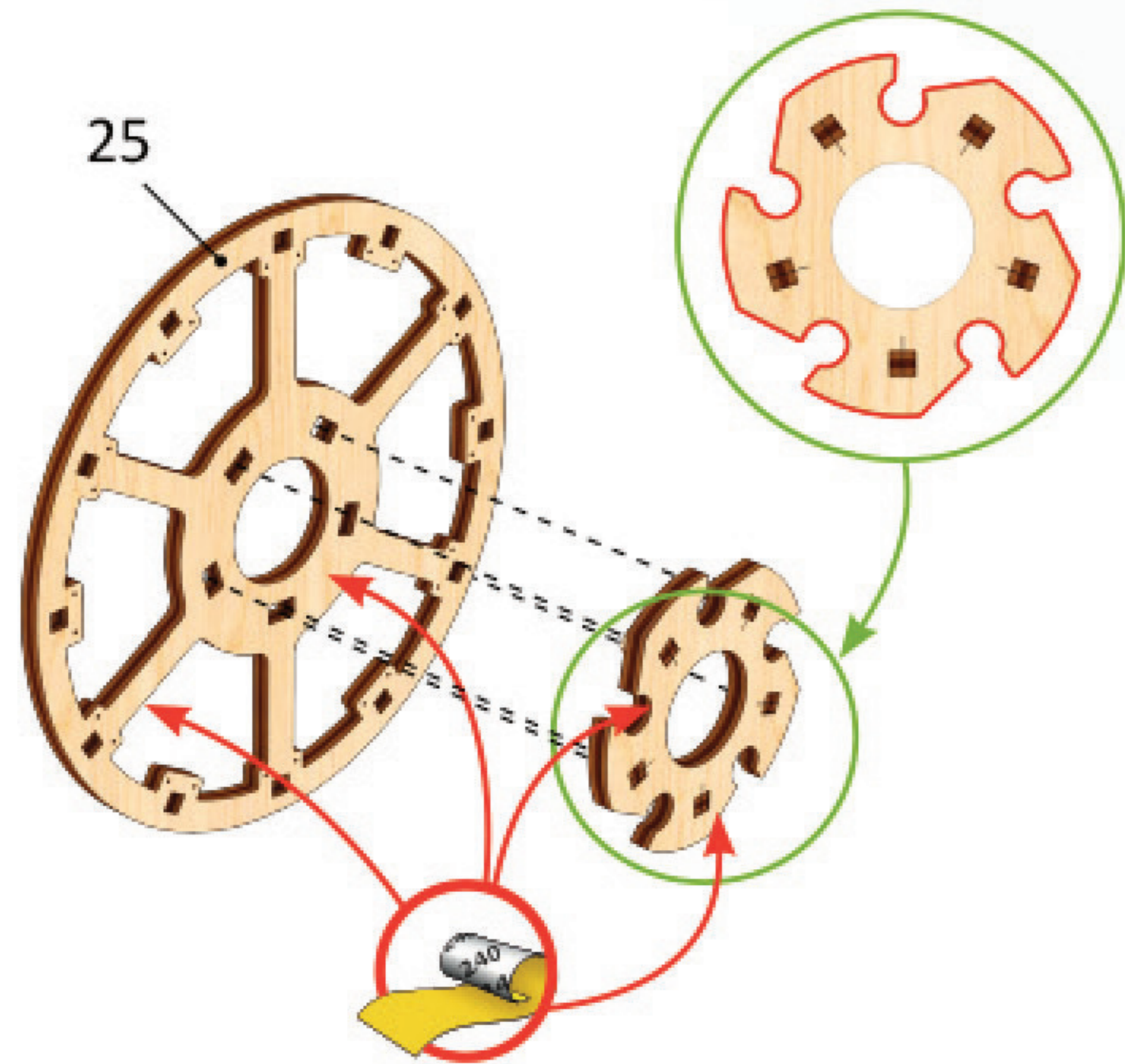

2

9

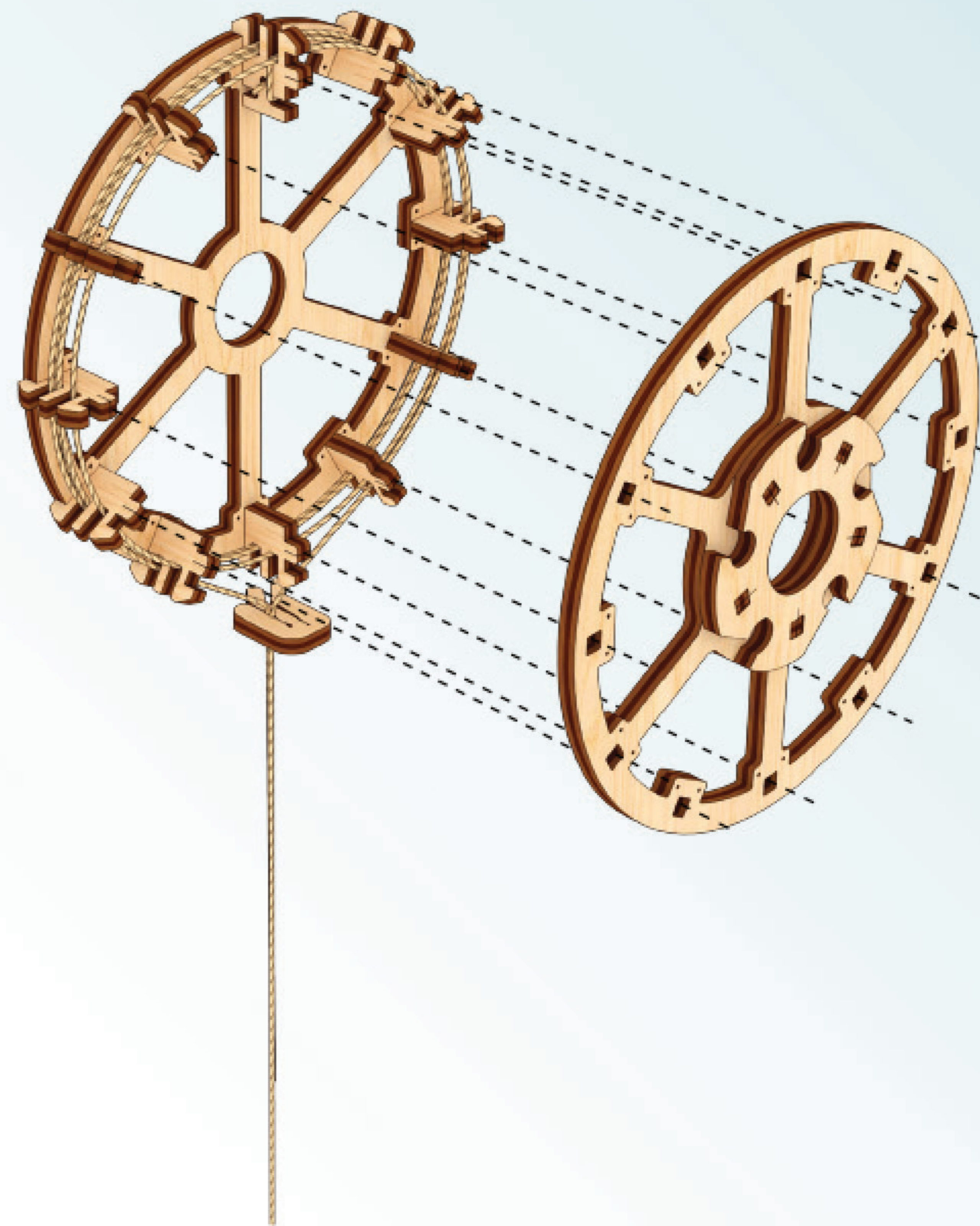
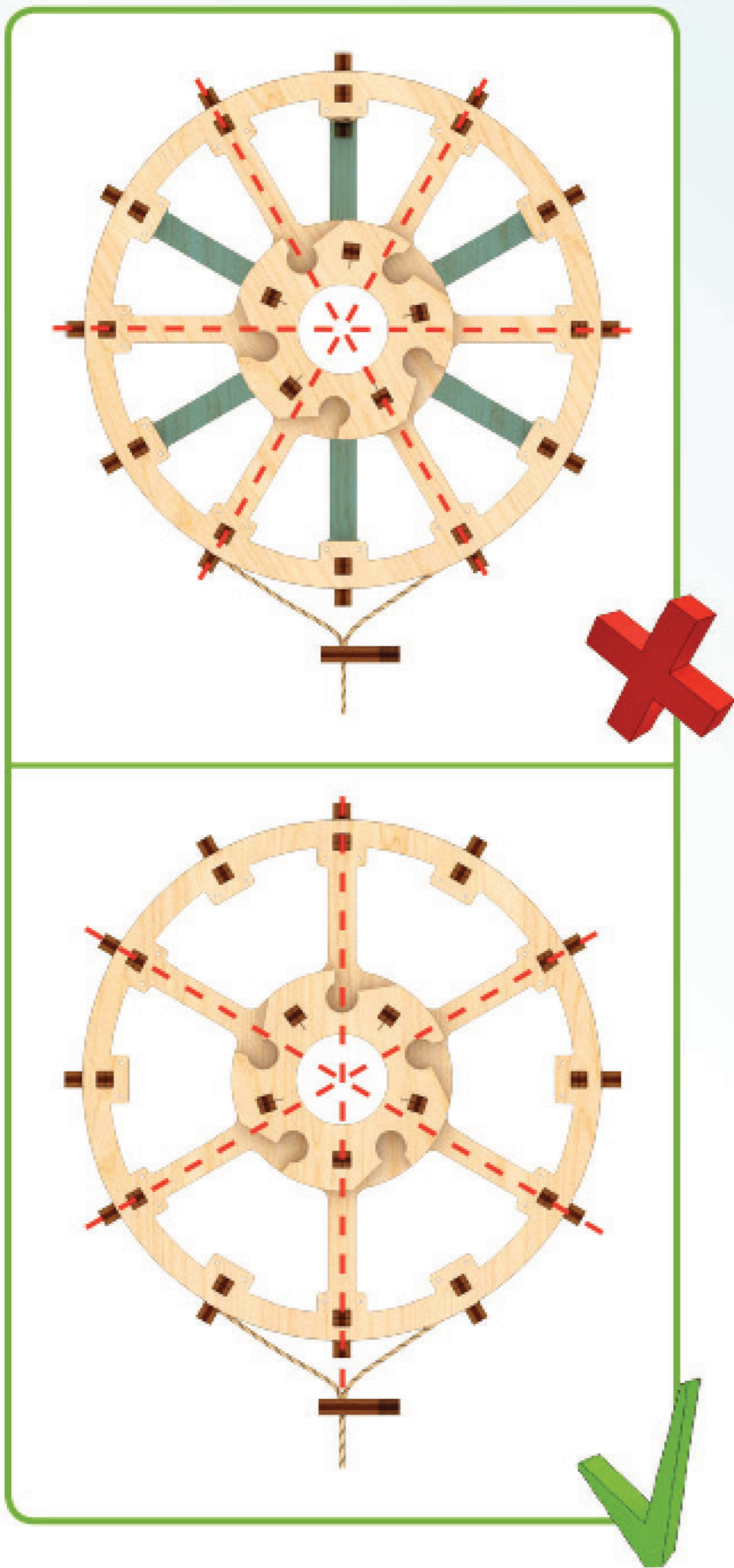

a2



9

1

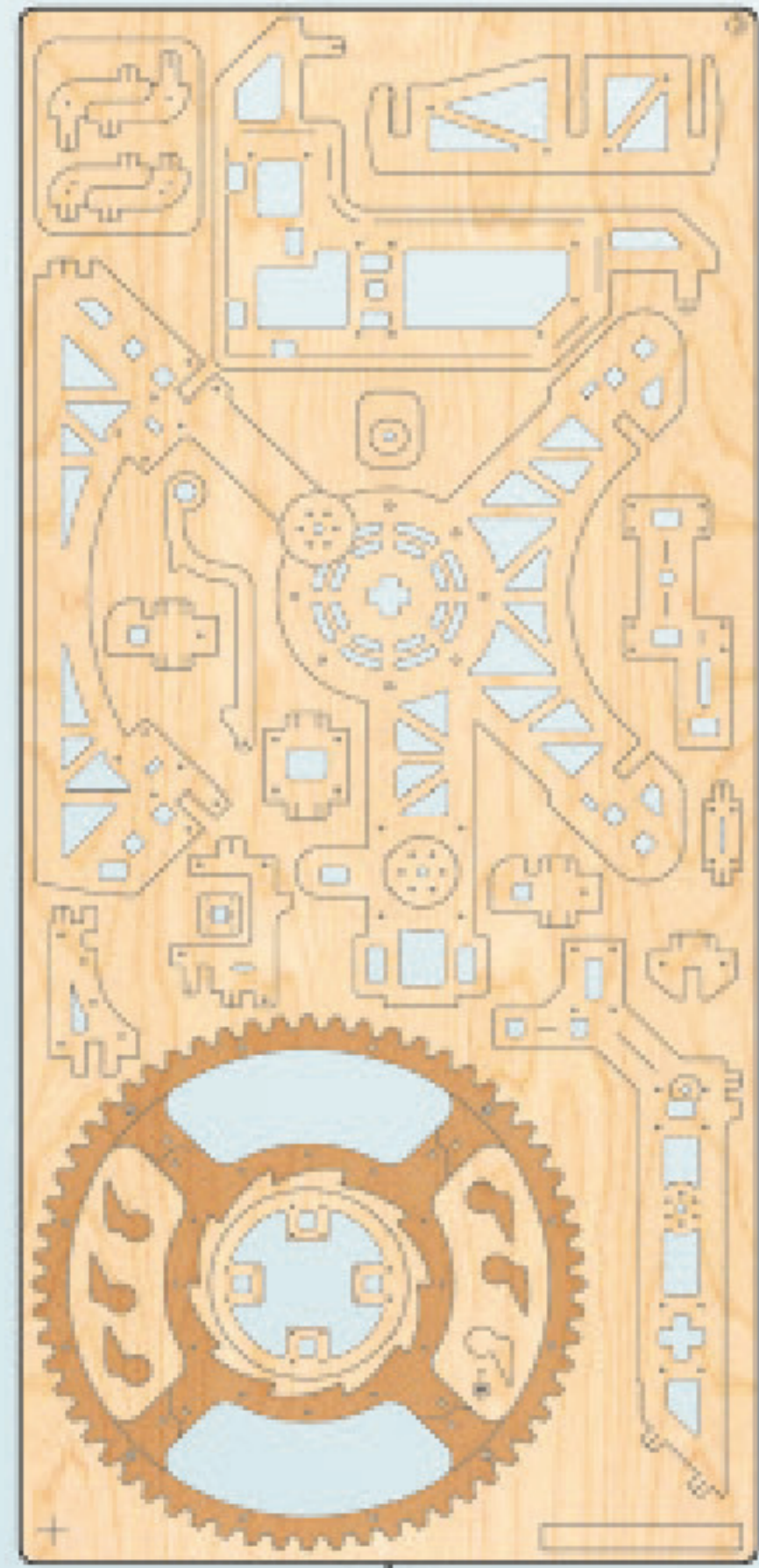

3

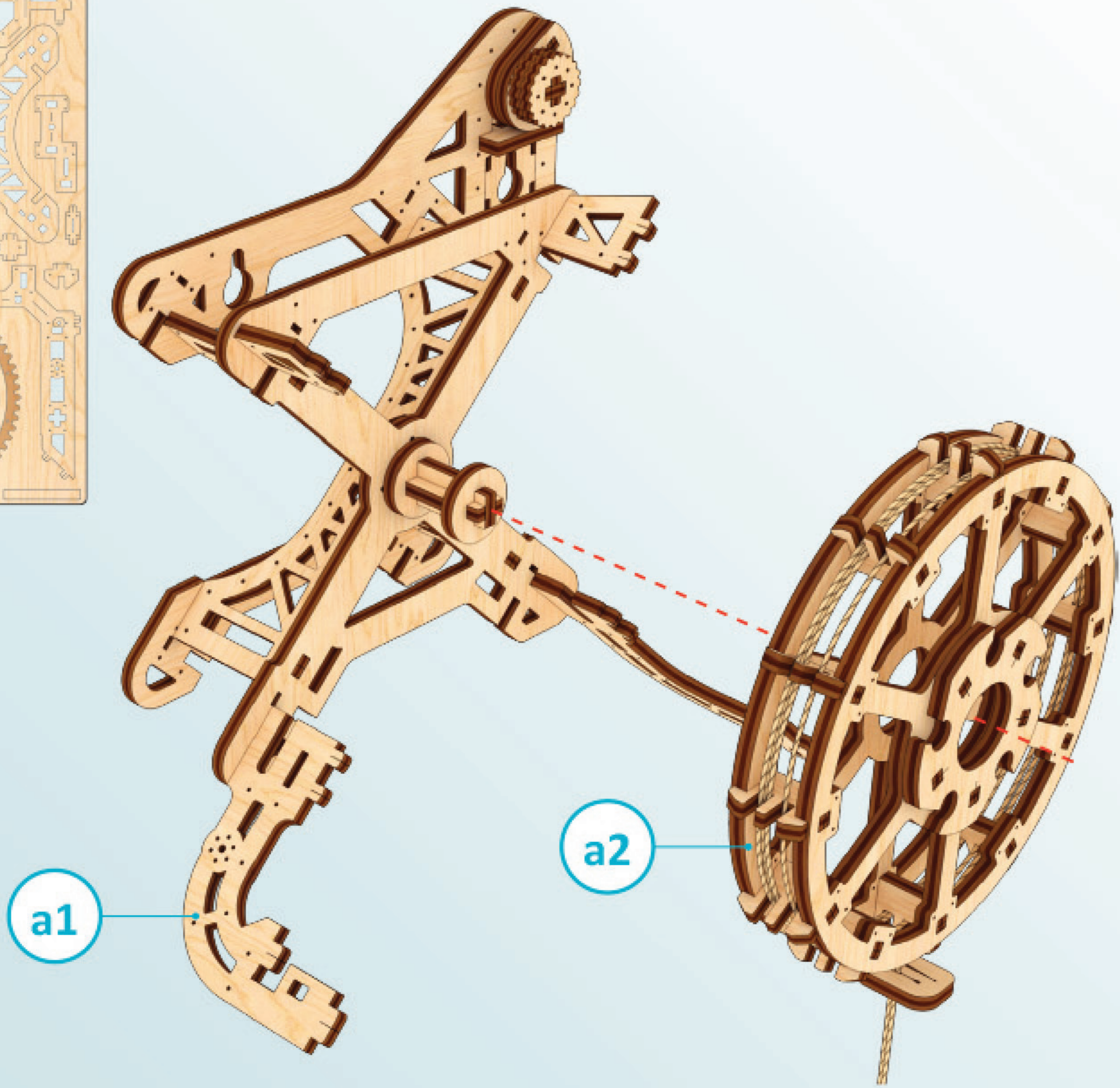

a1

a2

2

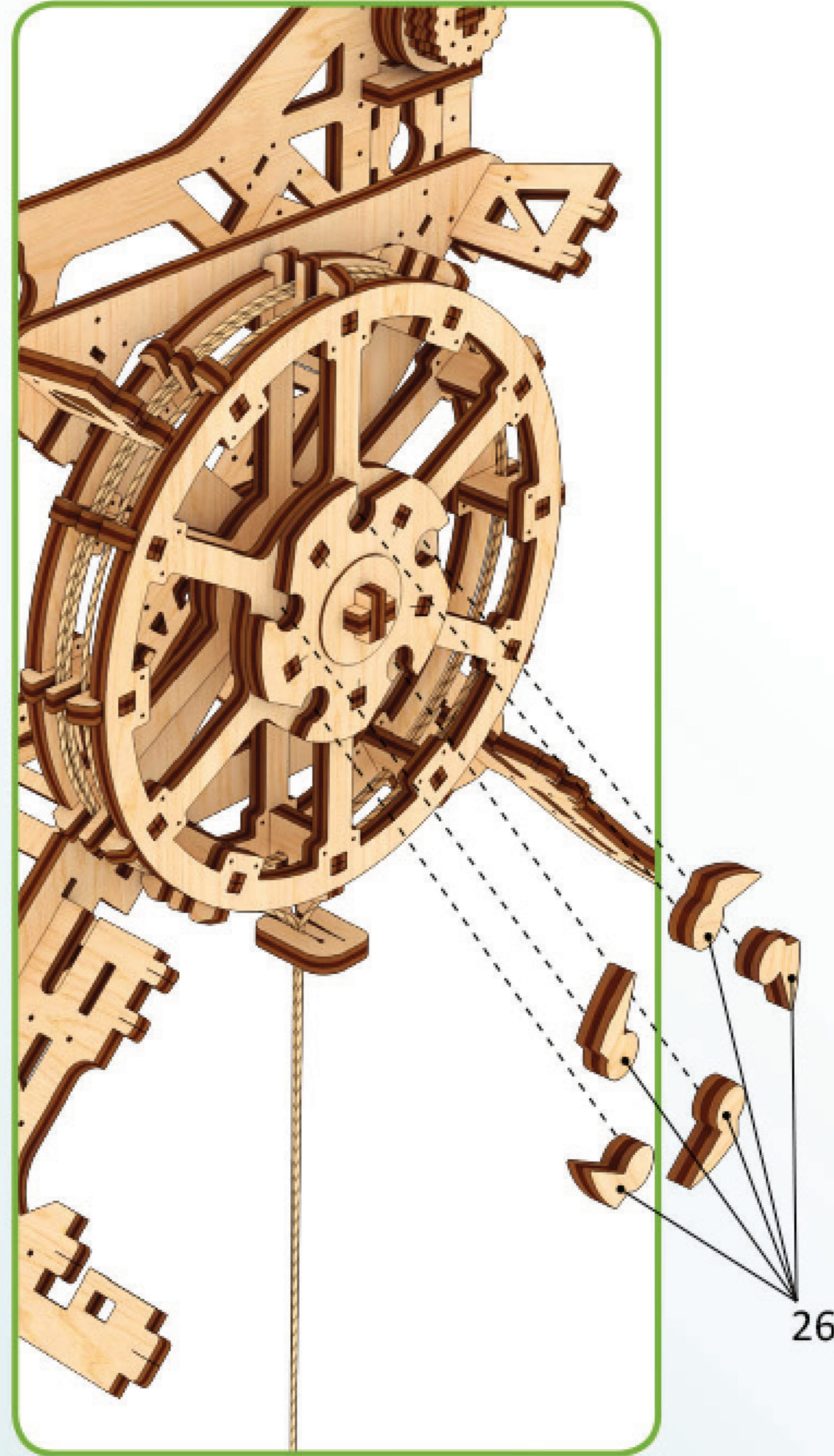

26

3

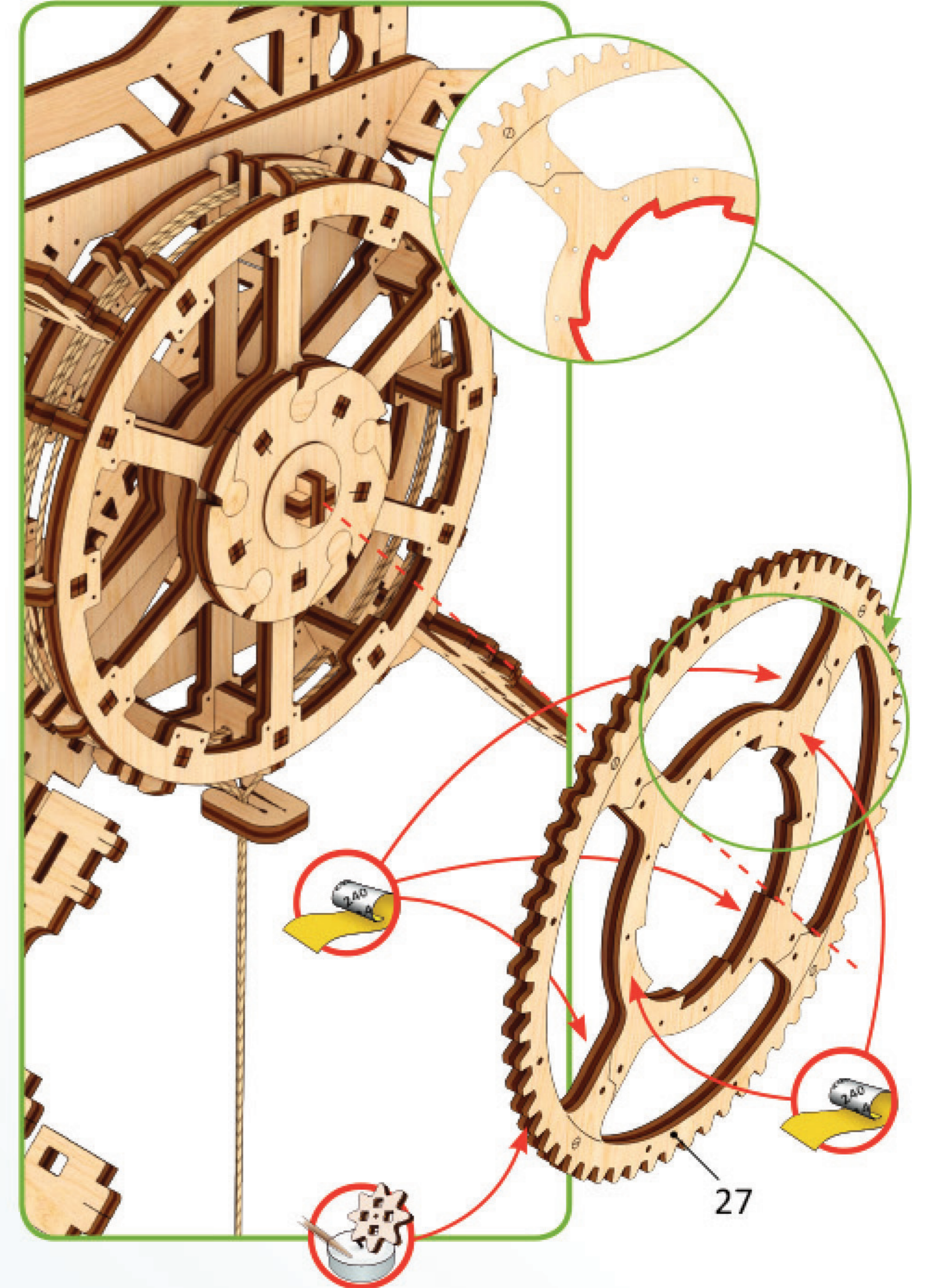

27

4

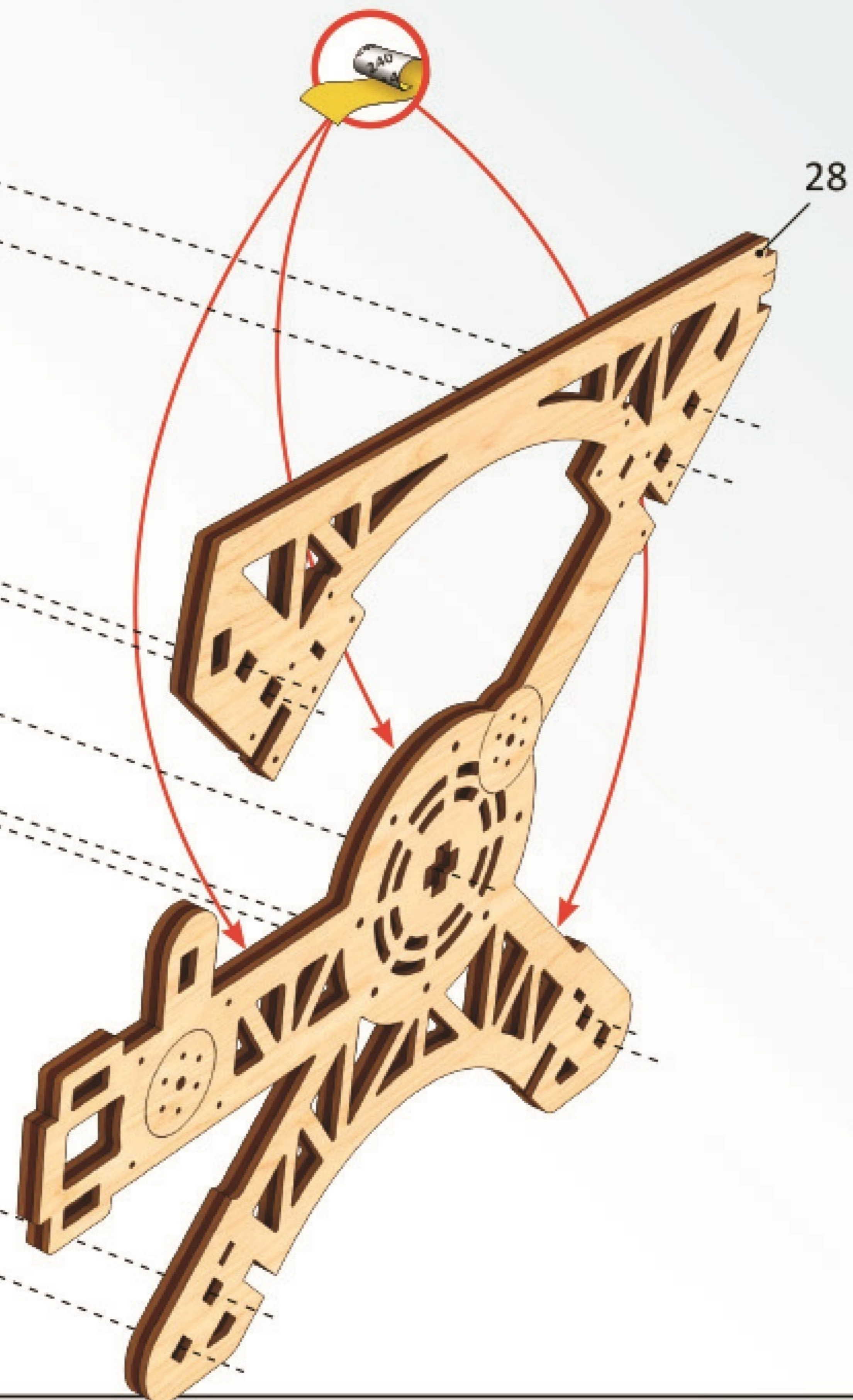
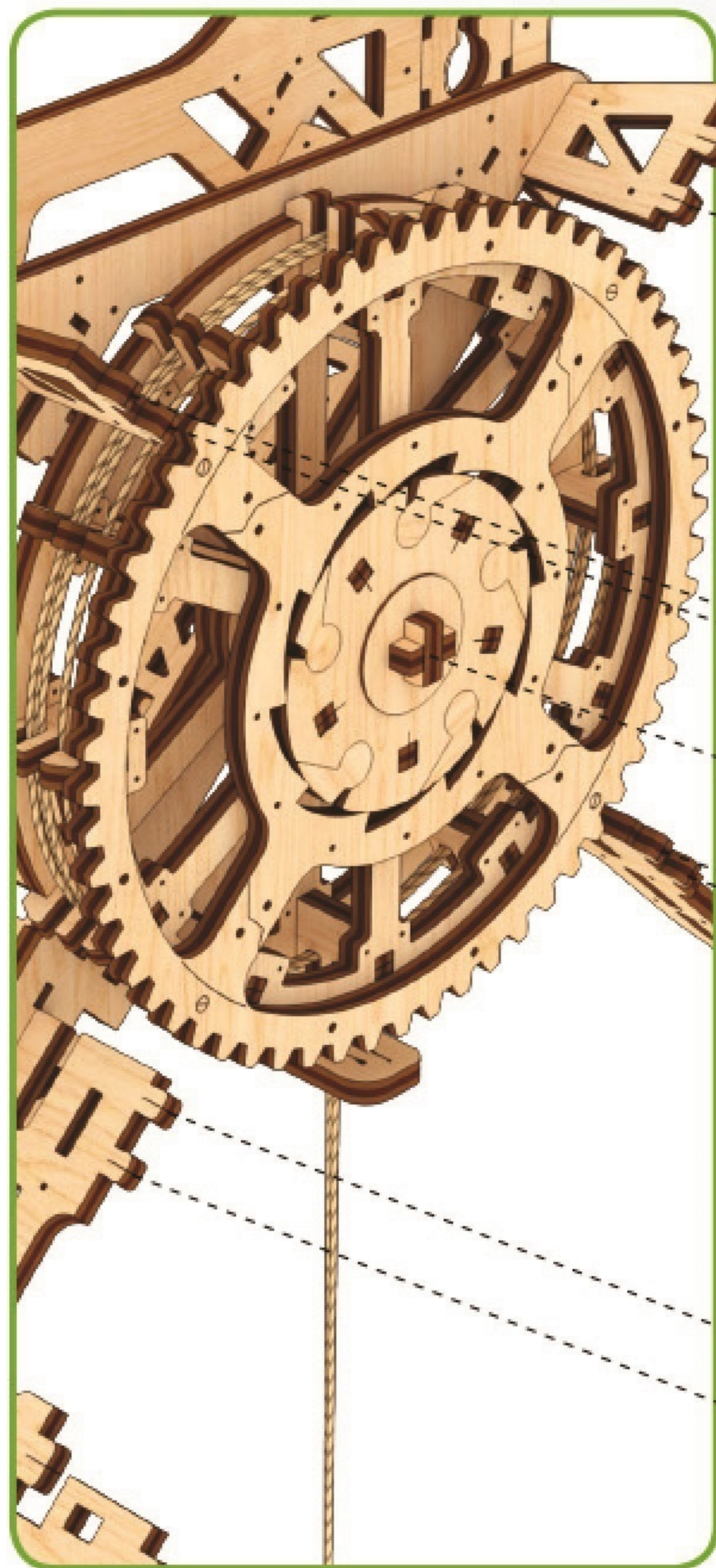
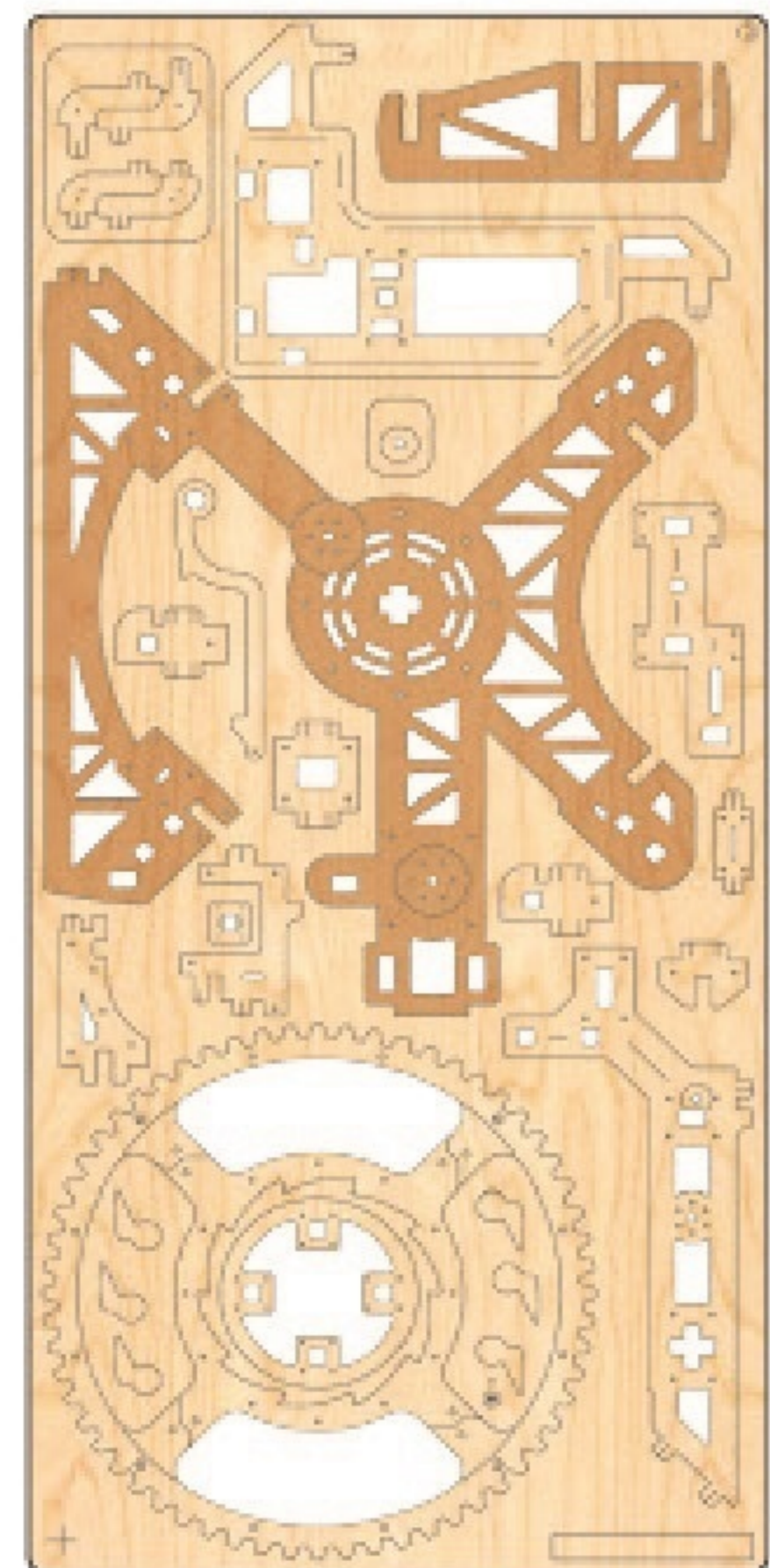

5

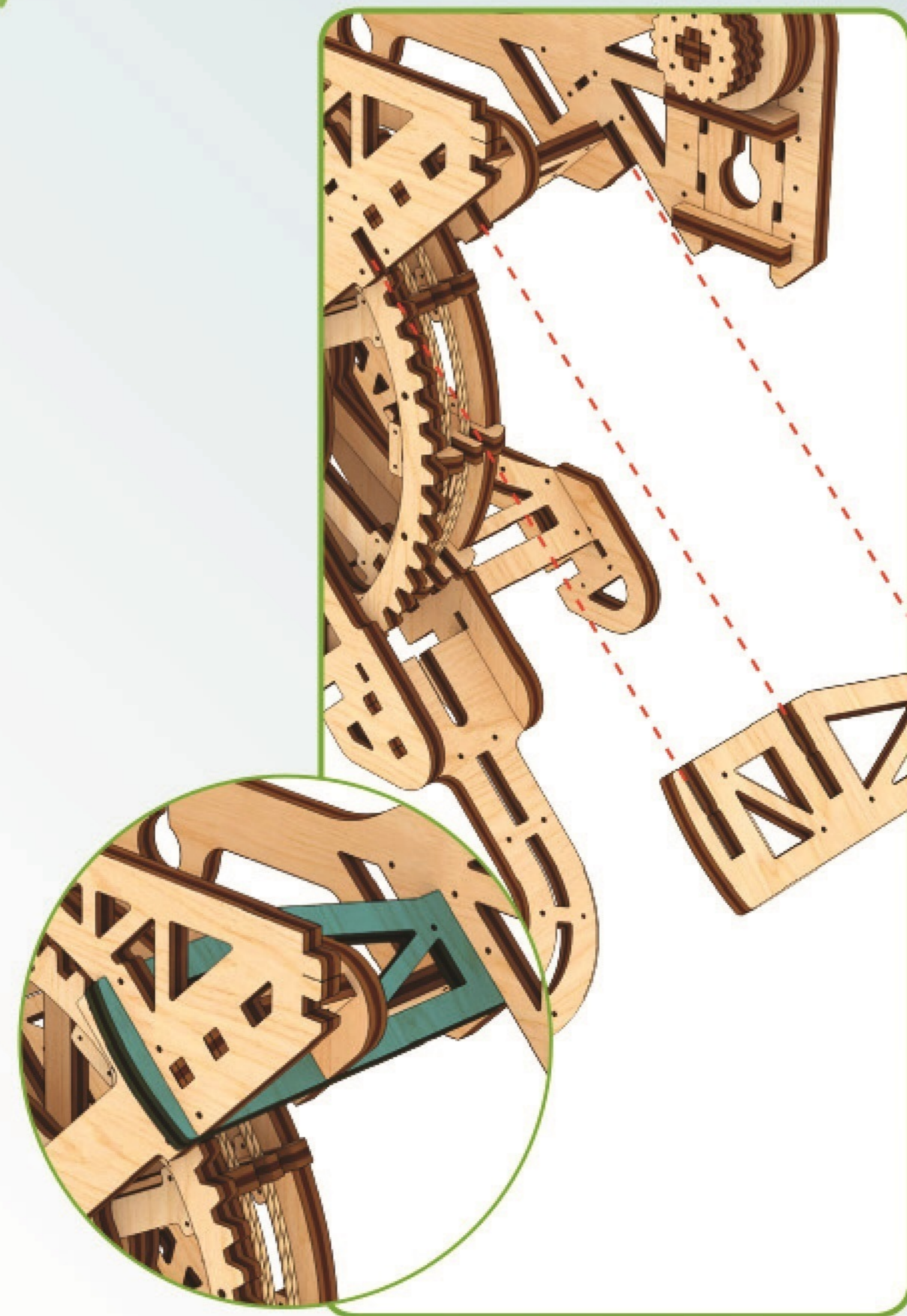

Druk de onderdelen aan zover als ze willen gaan.

6

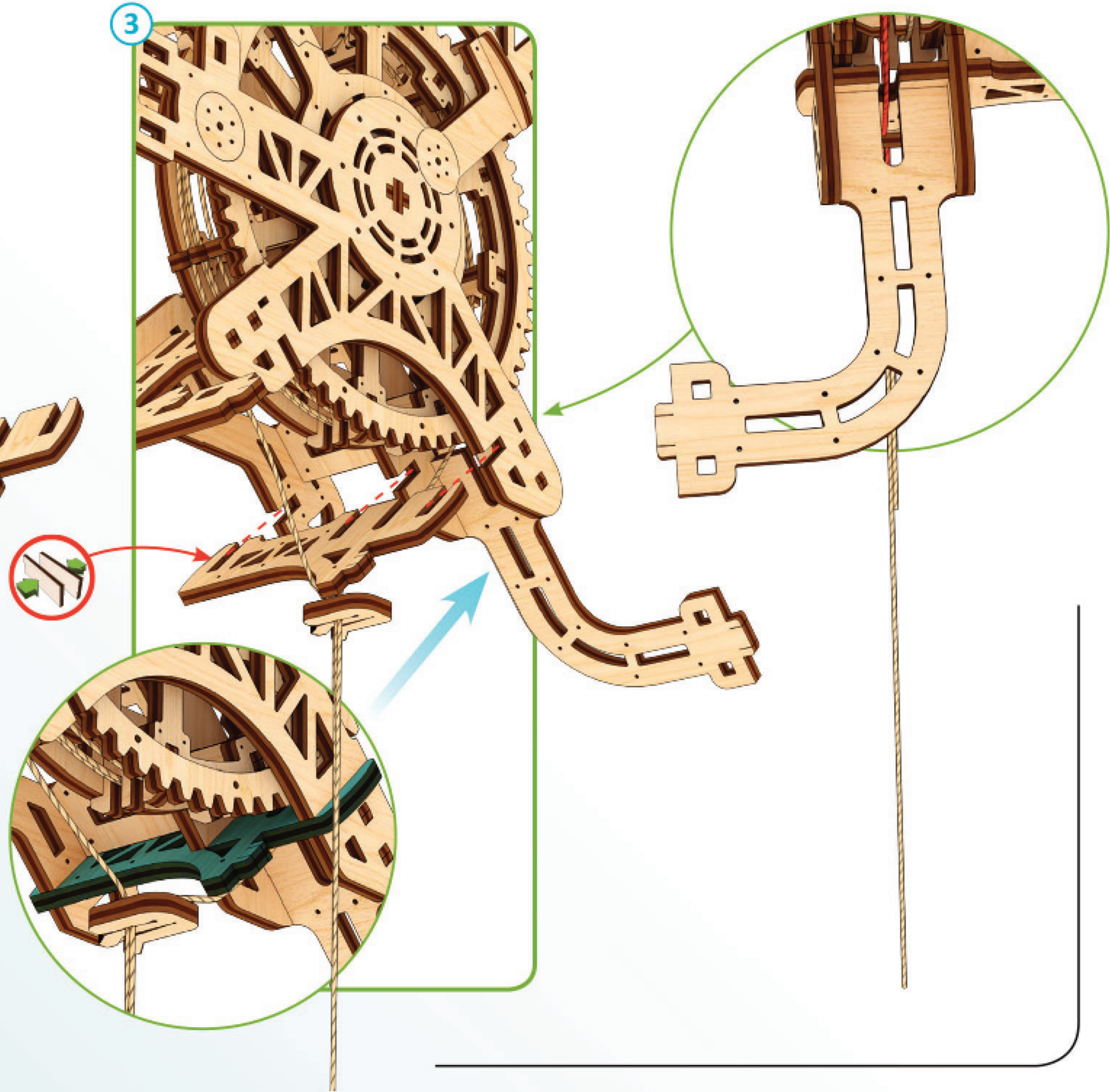
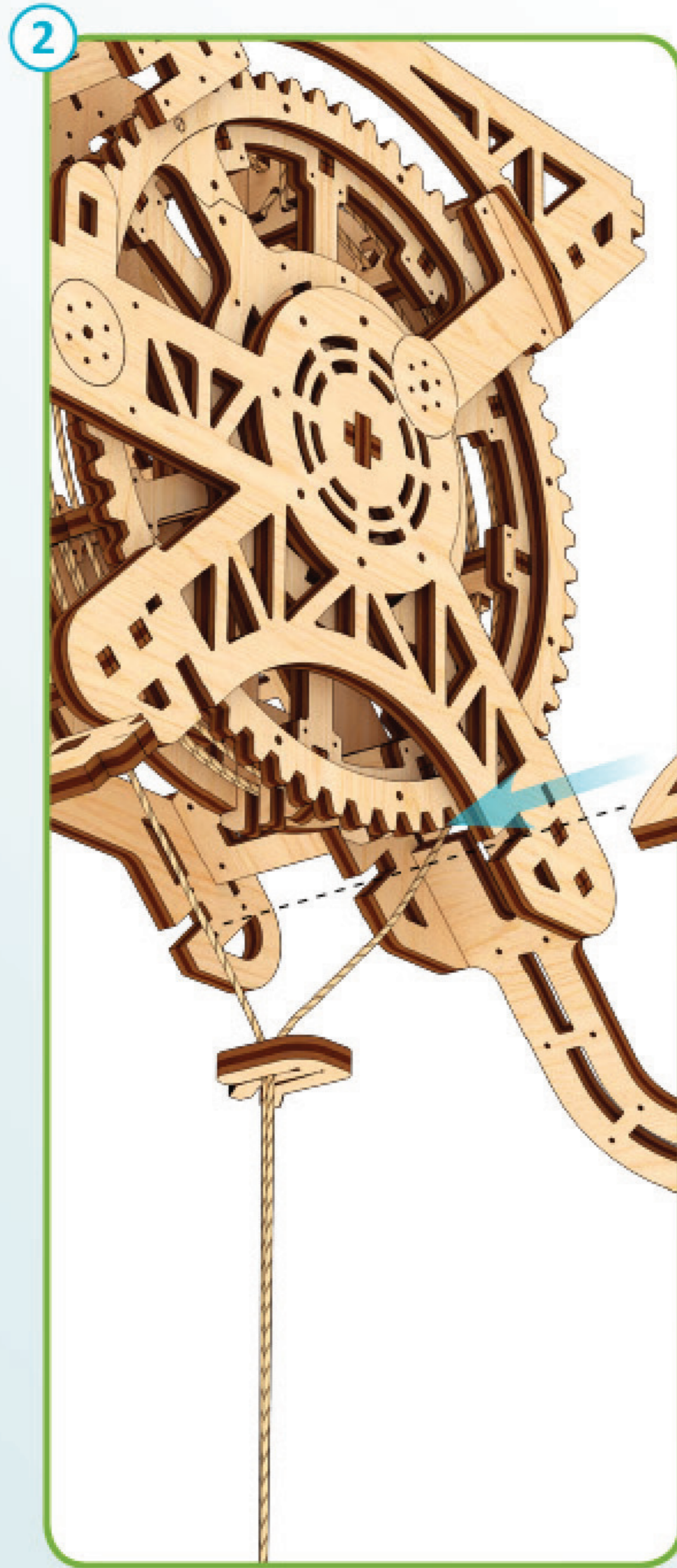
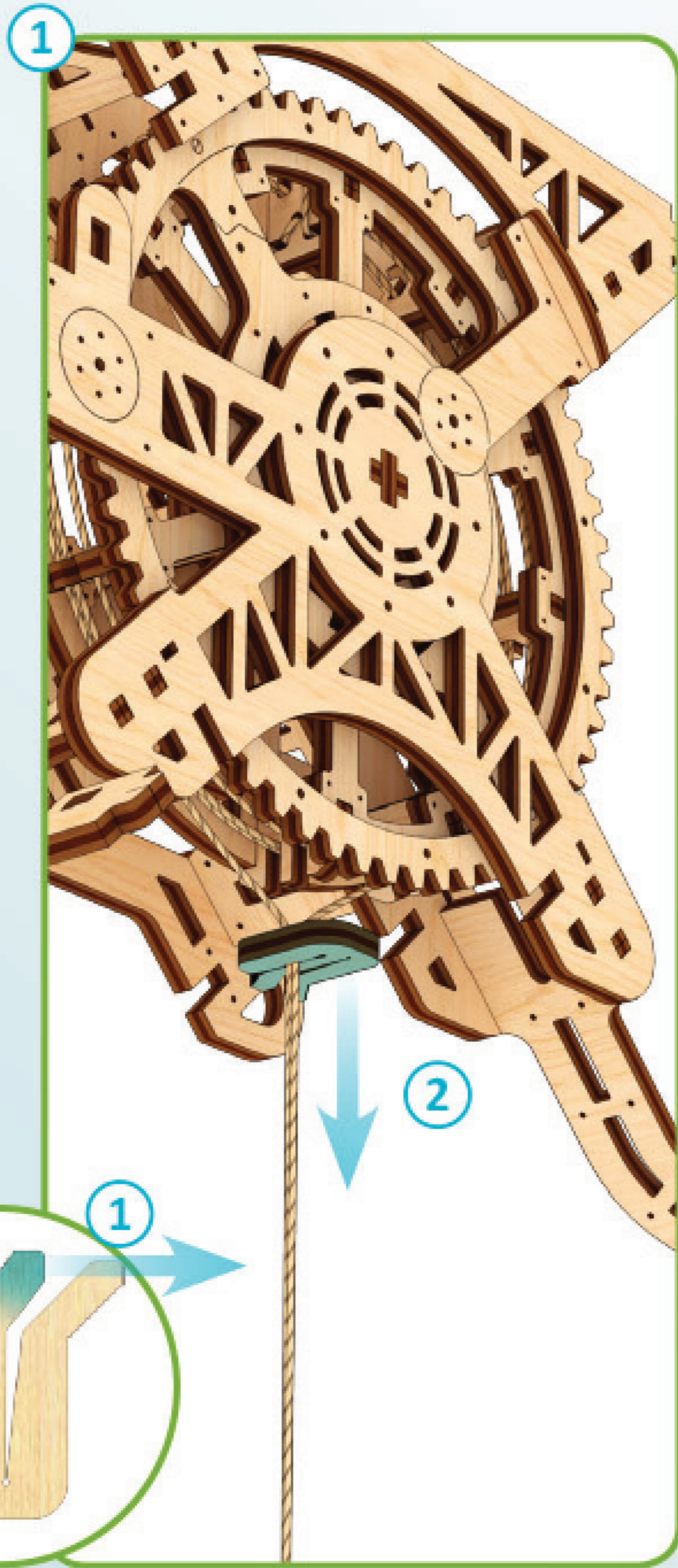
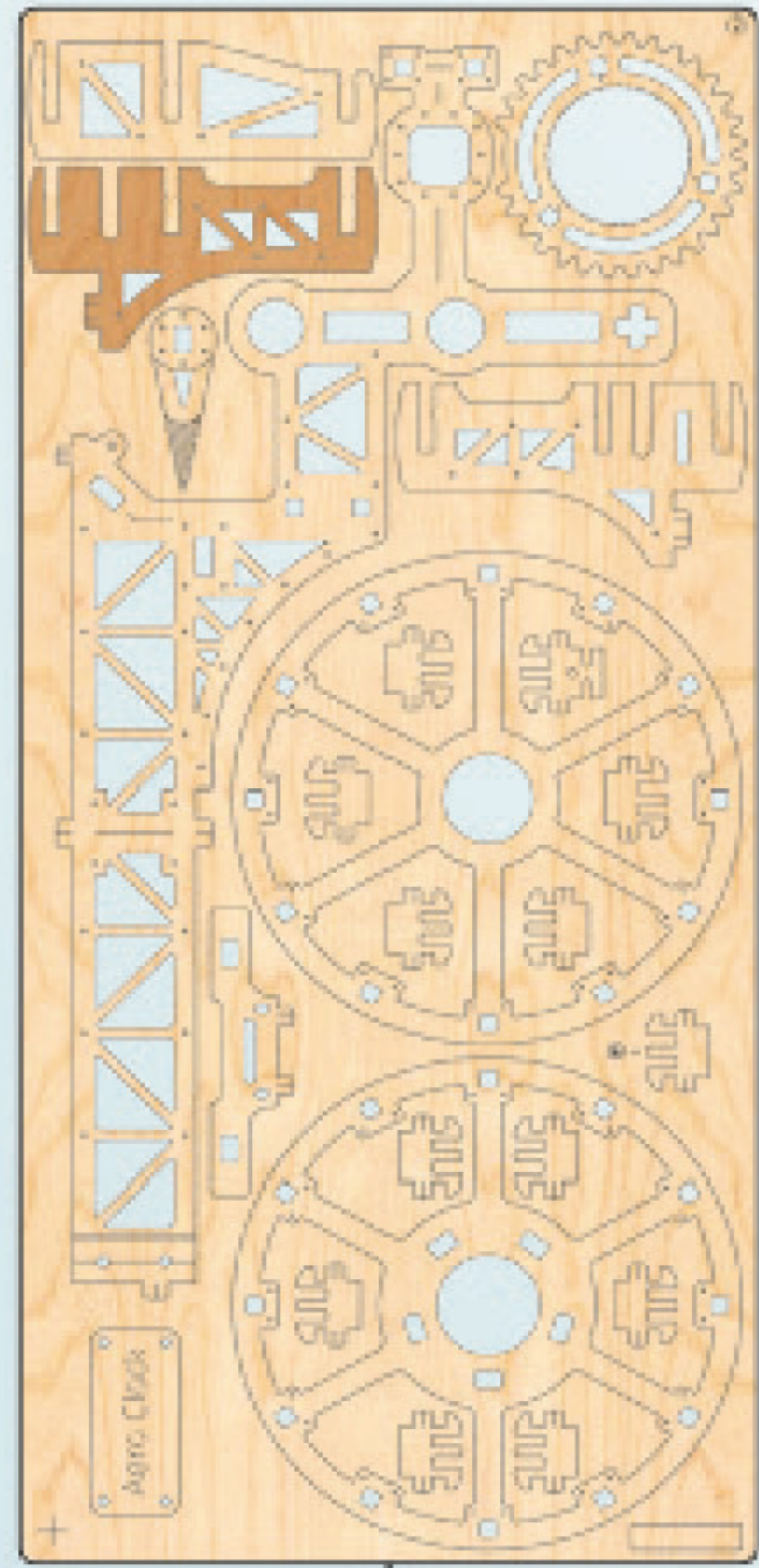

7

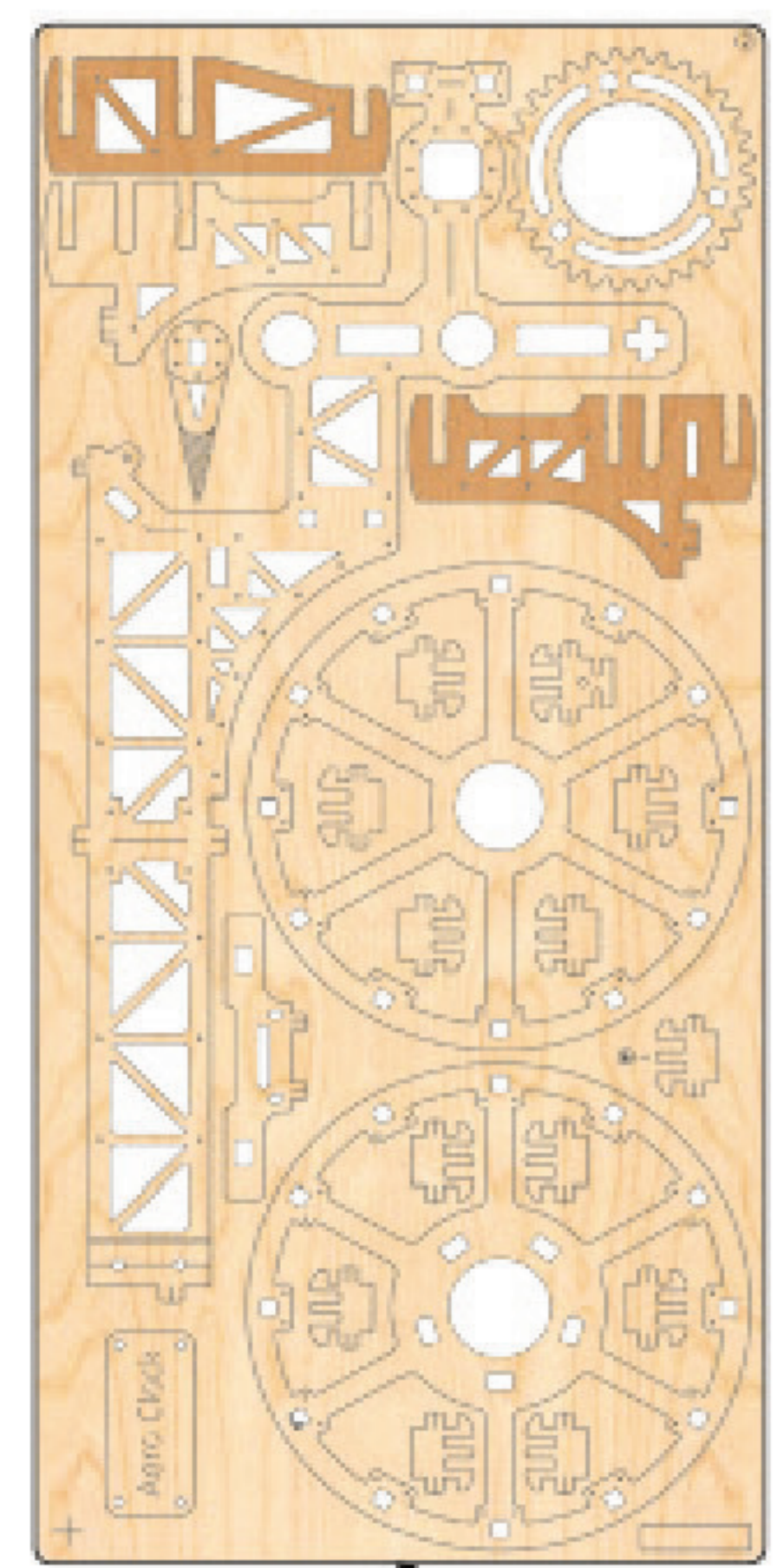

1

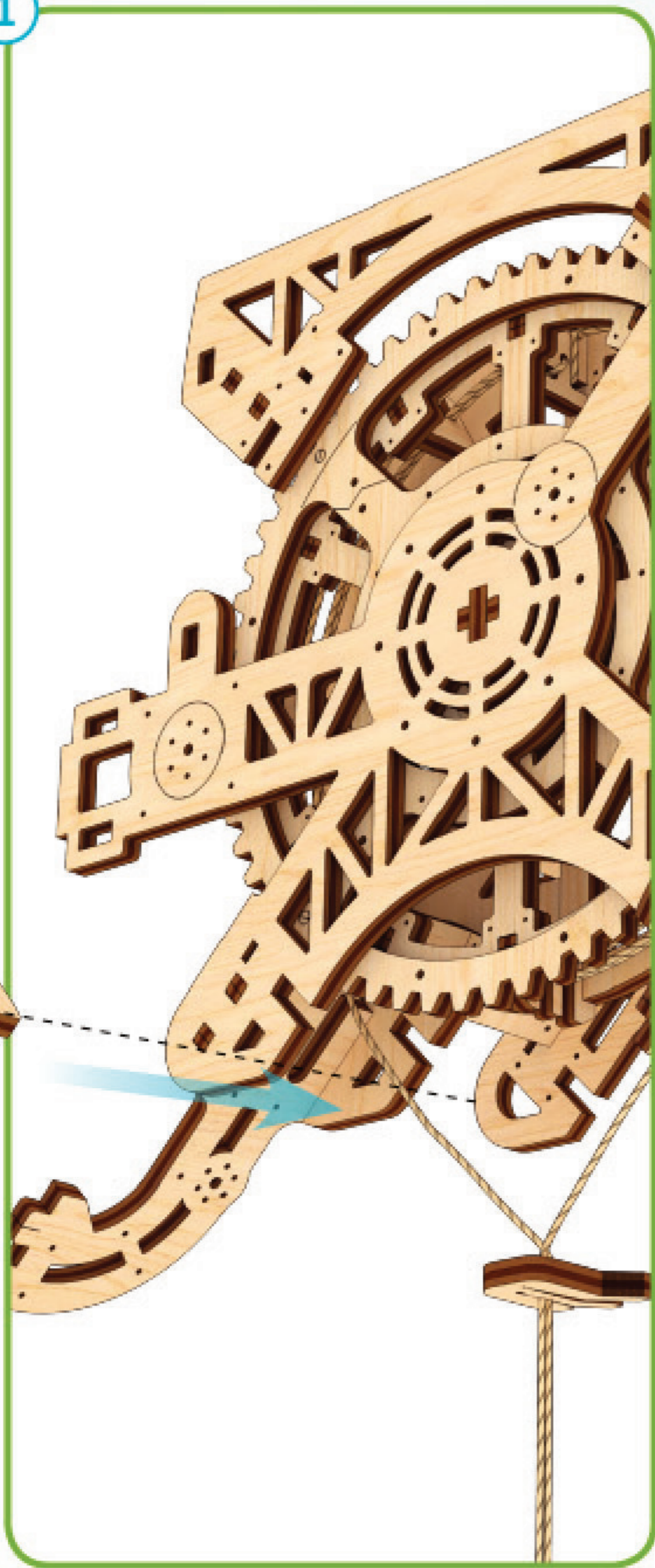

31

2

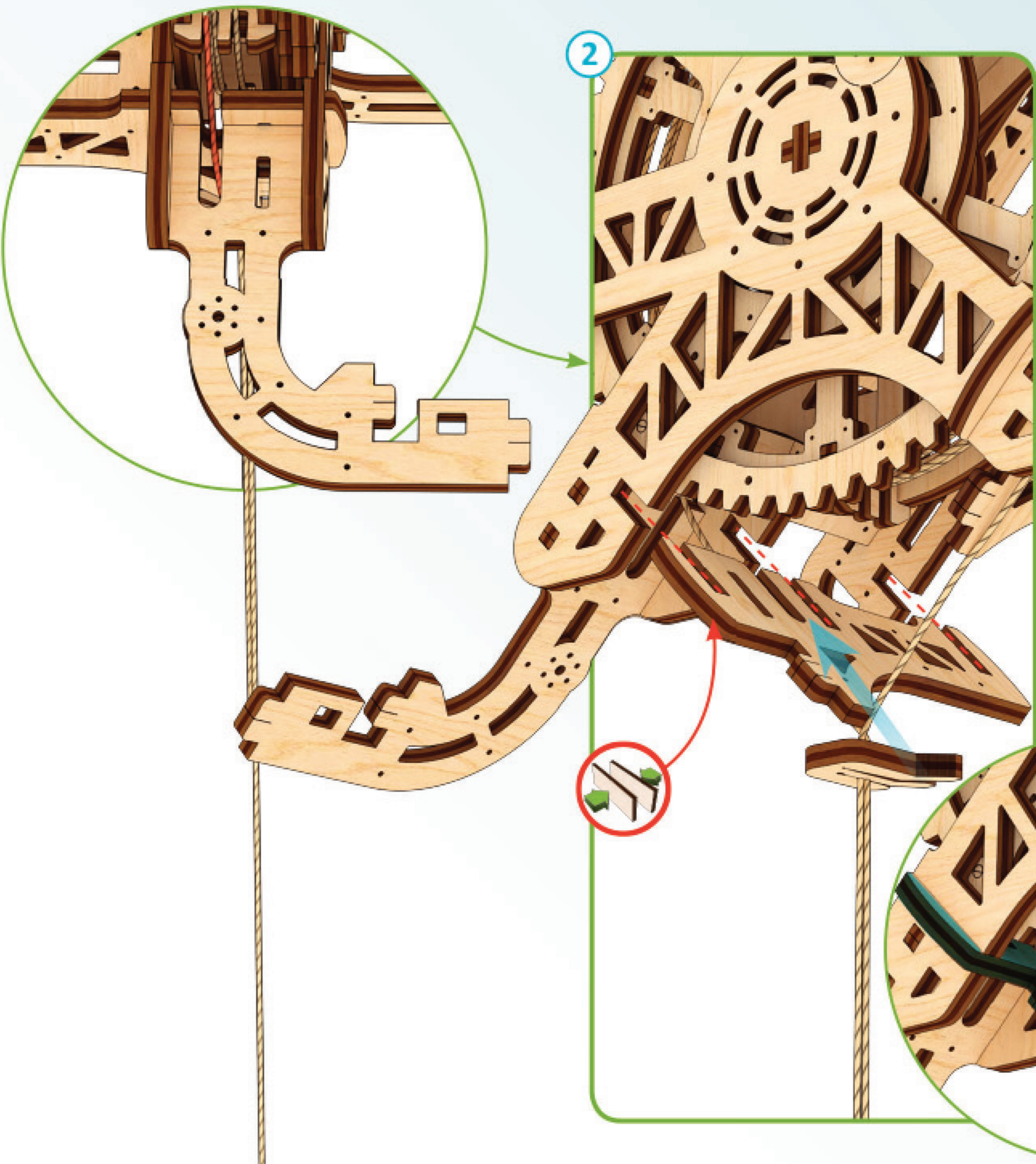

8

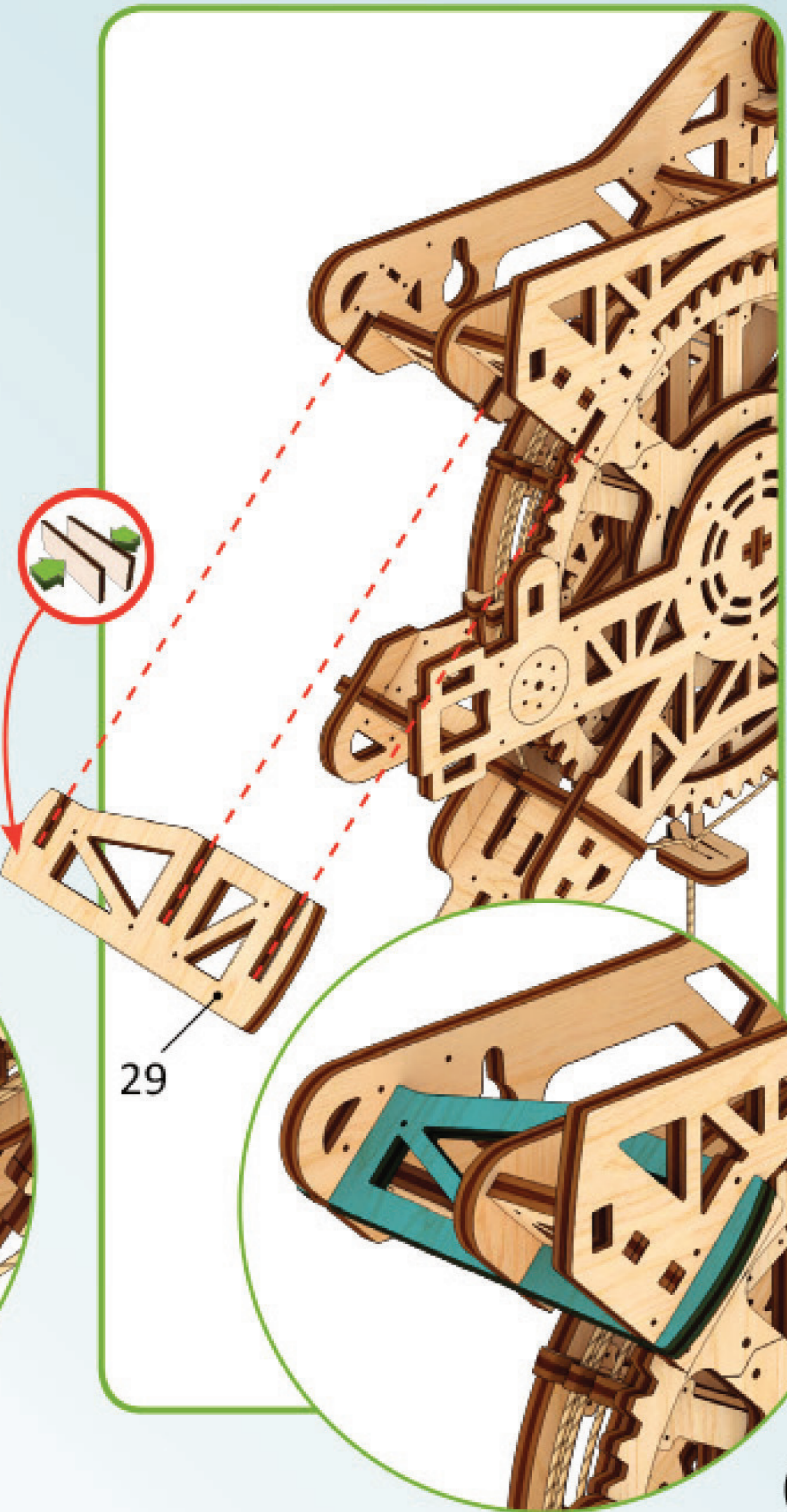

29

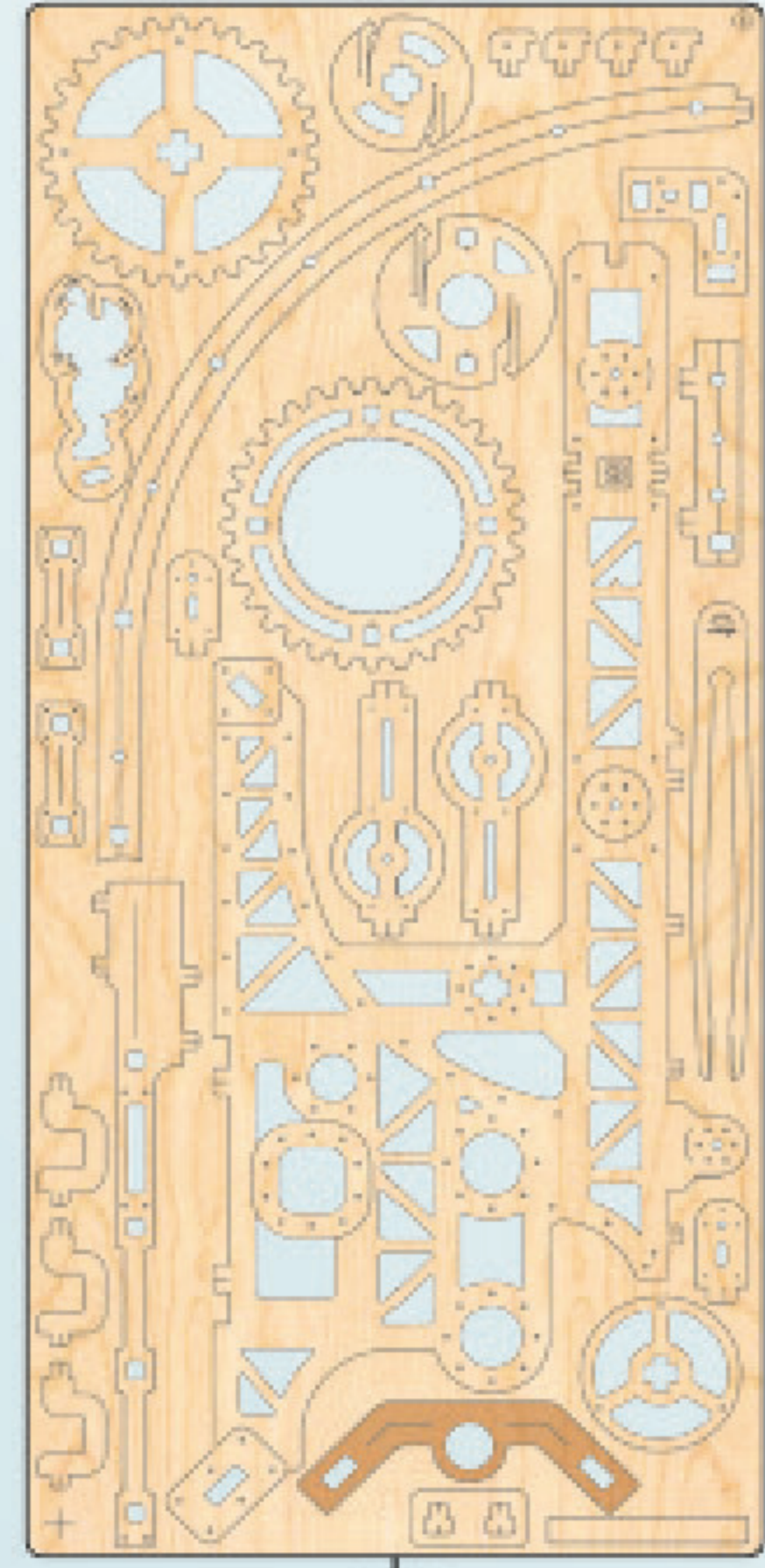

9

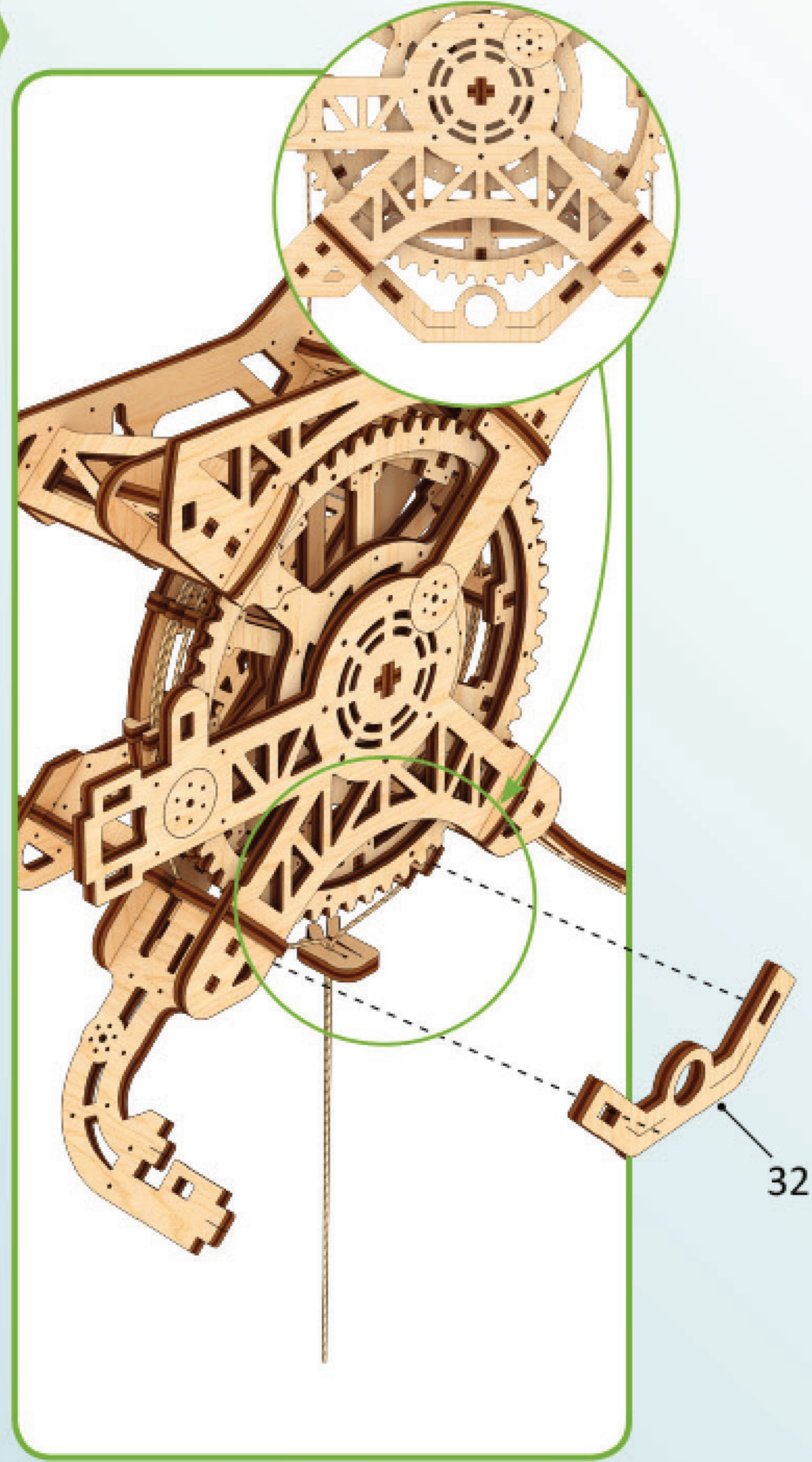

10

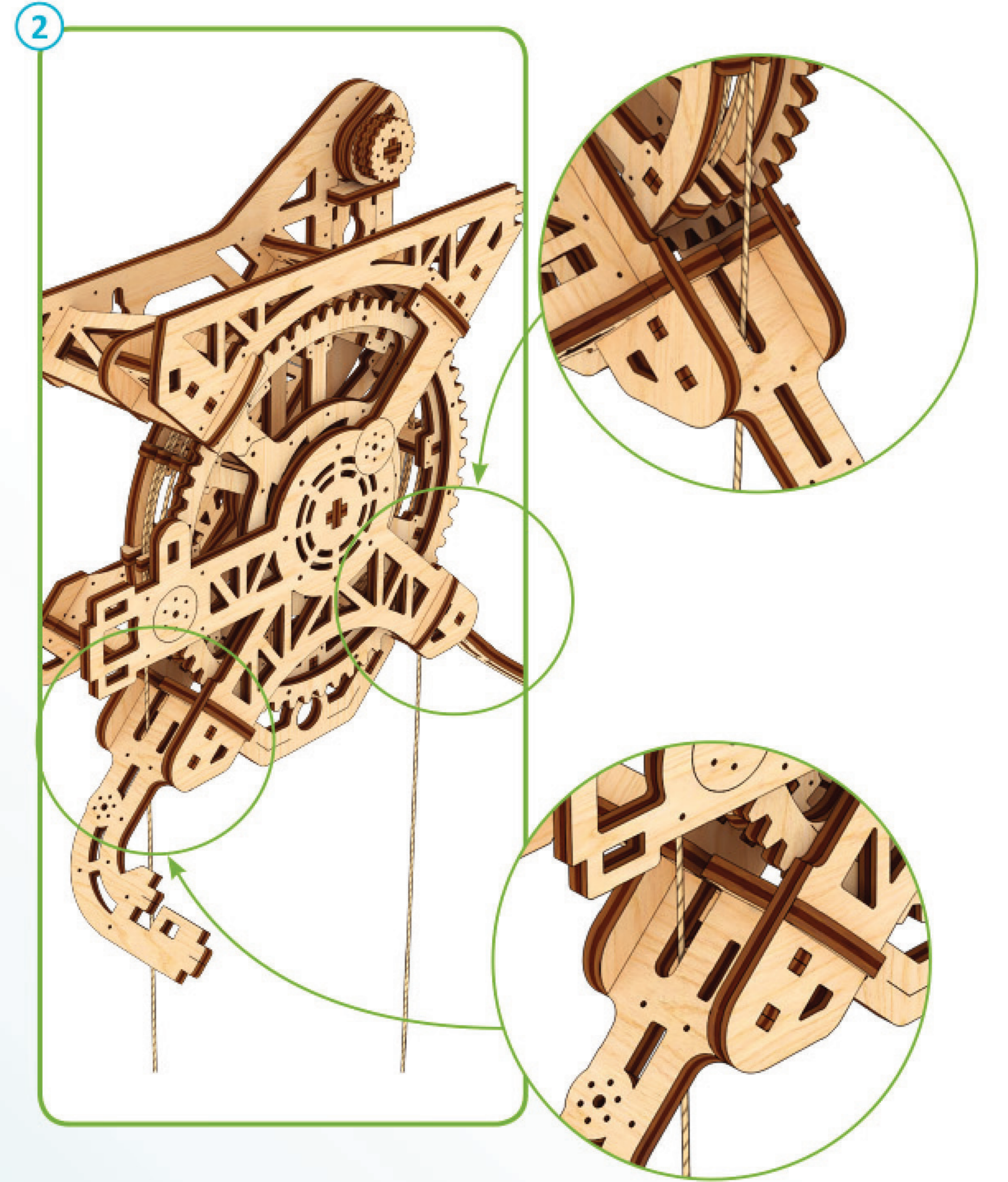
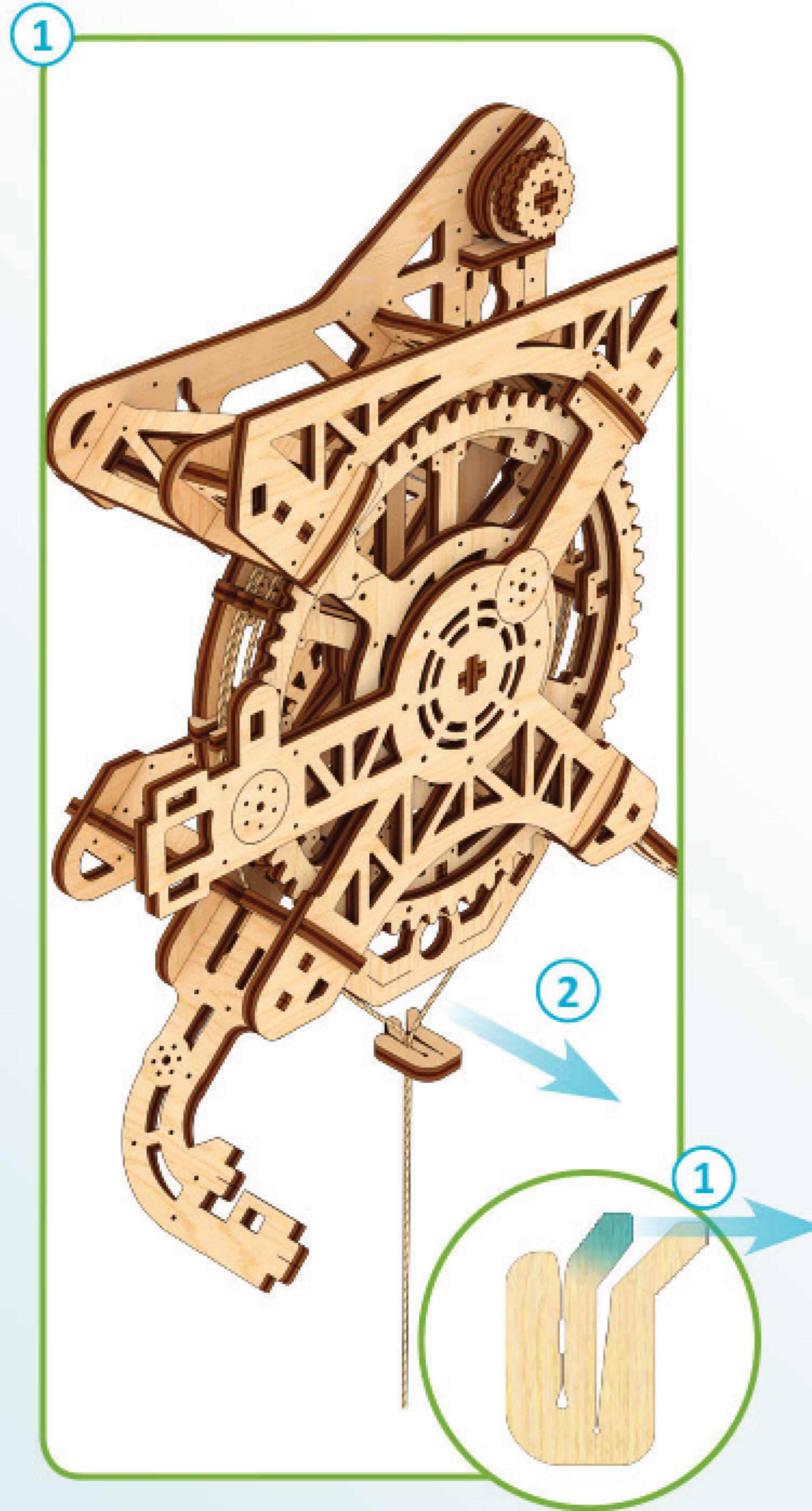

11

1

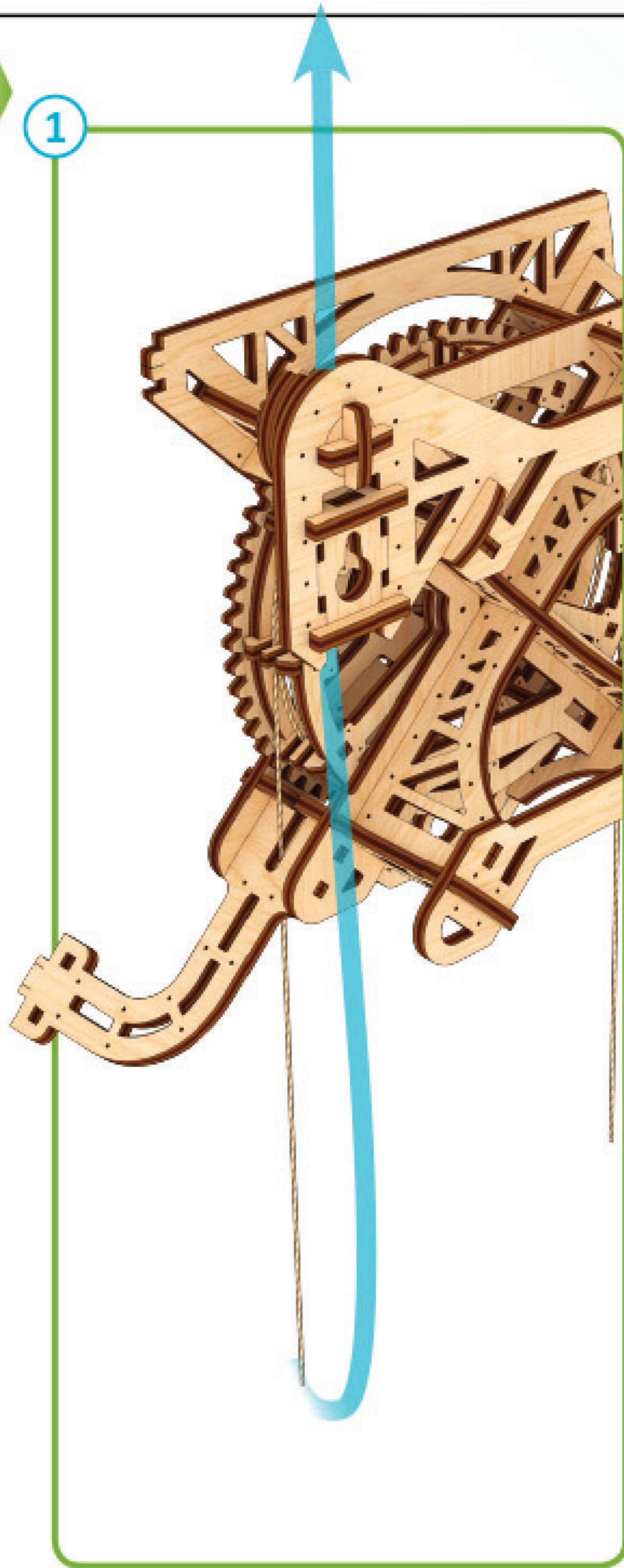

2

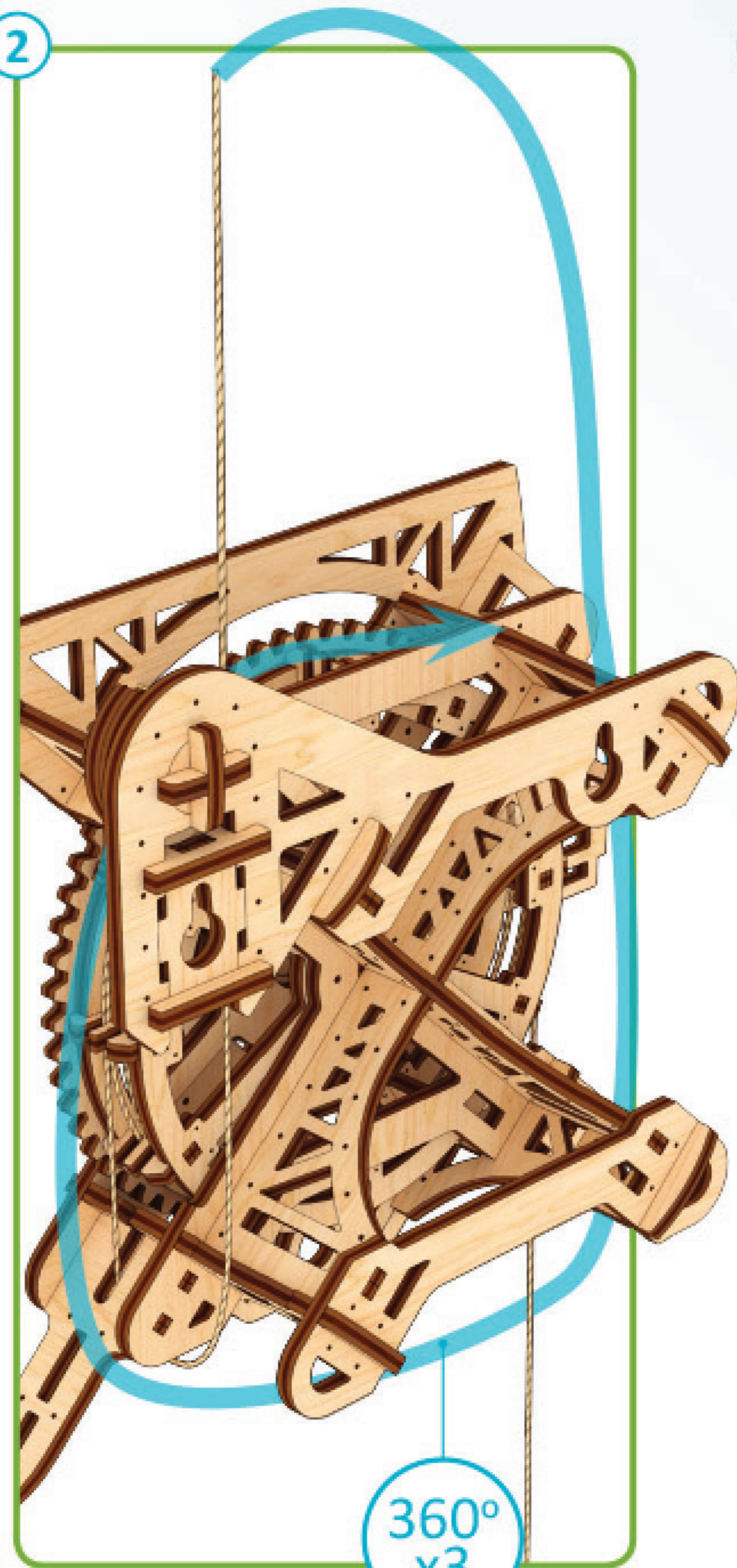

3

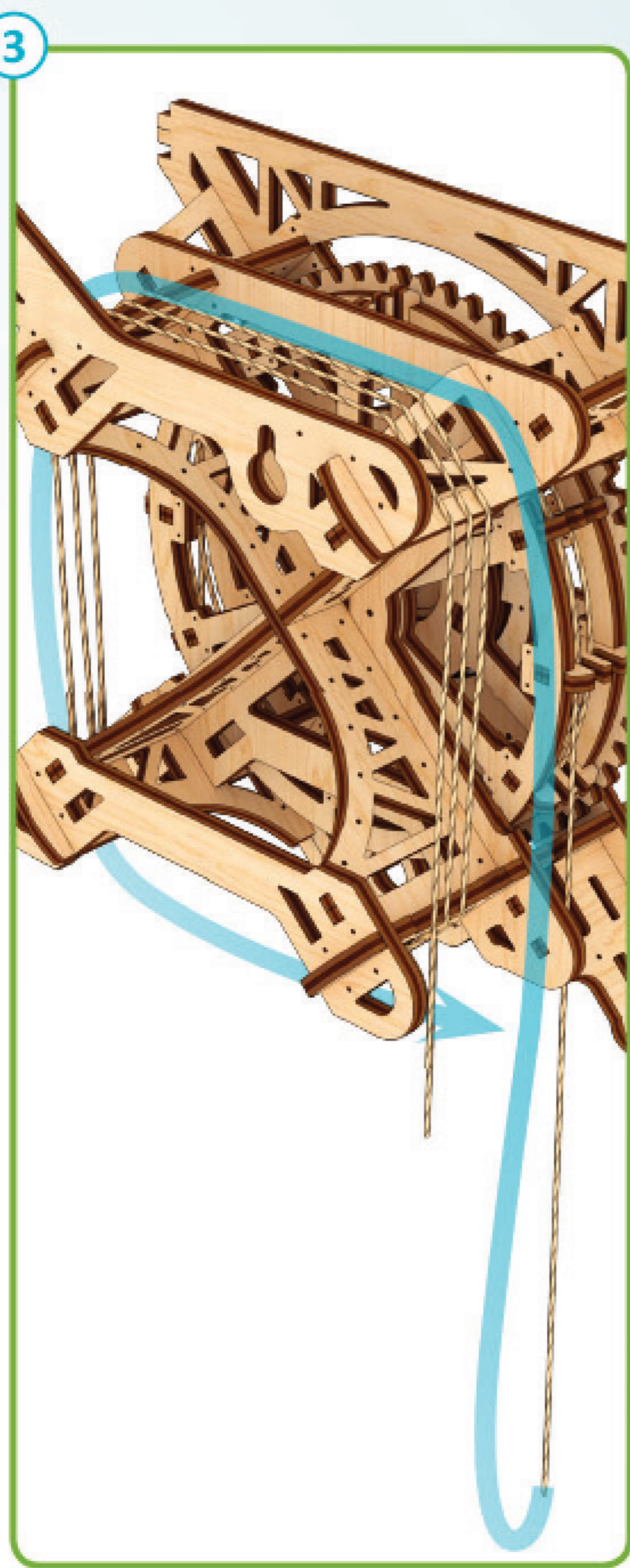

4

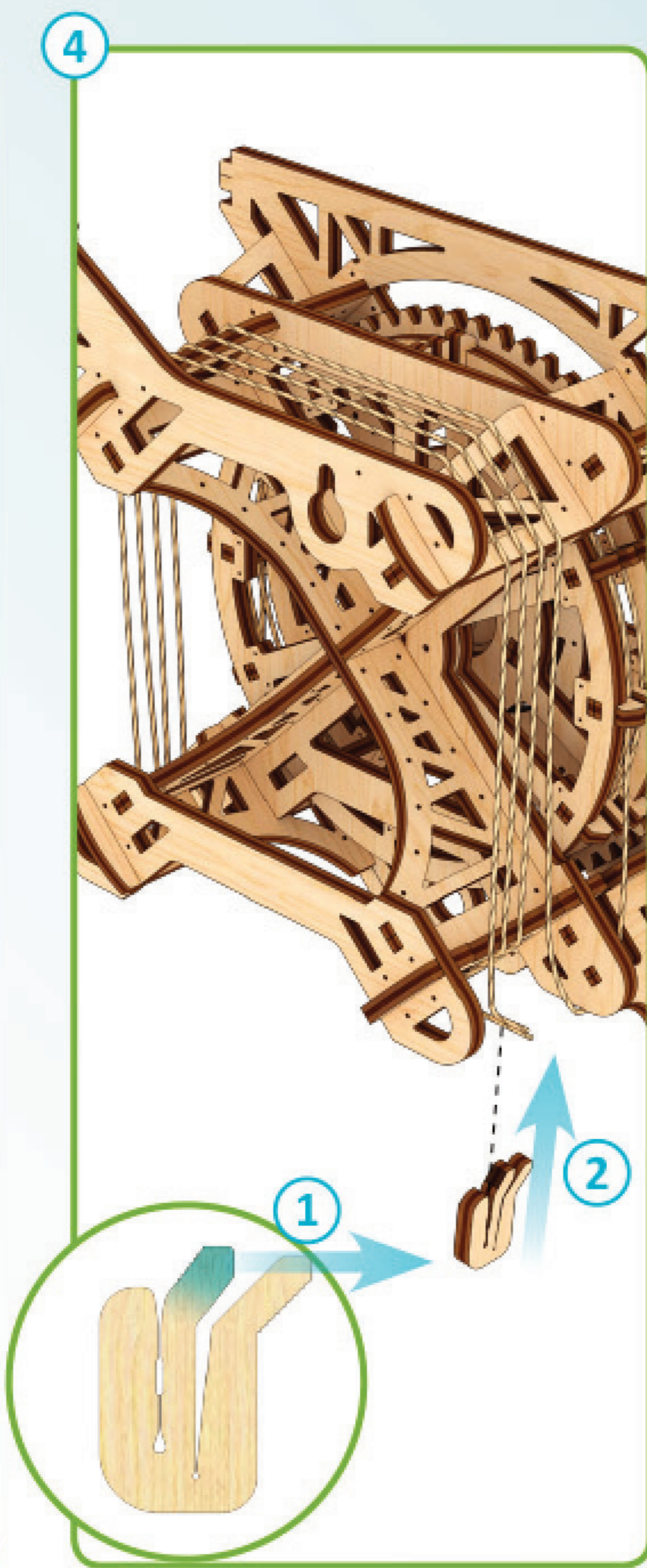

A

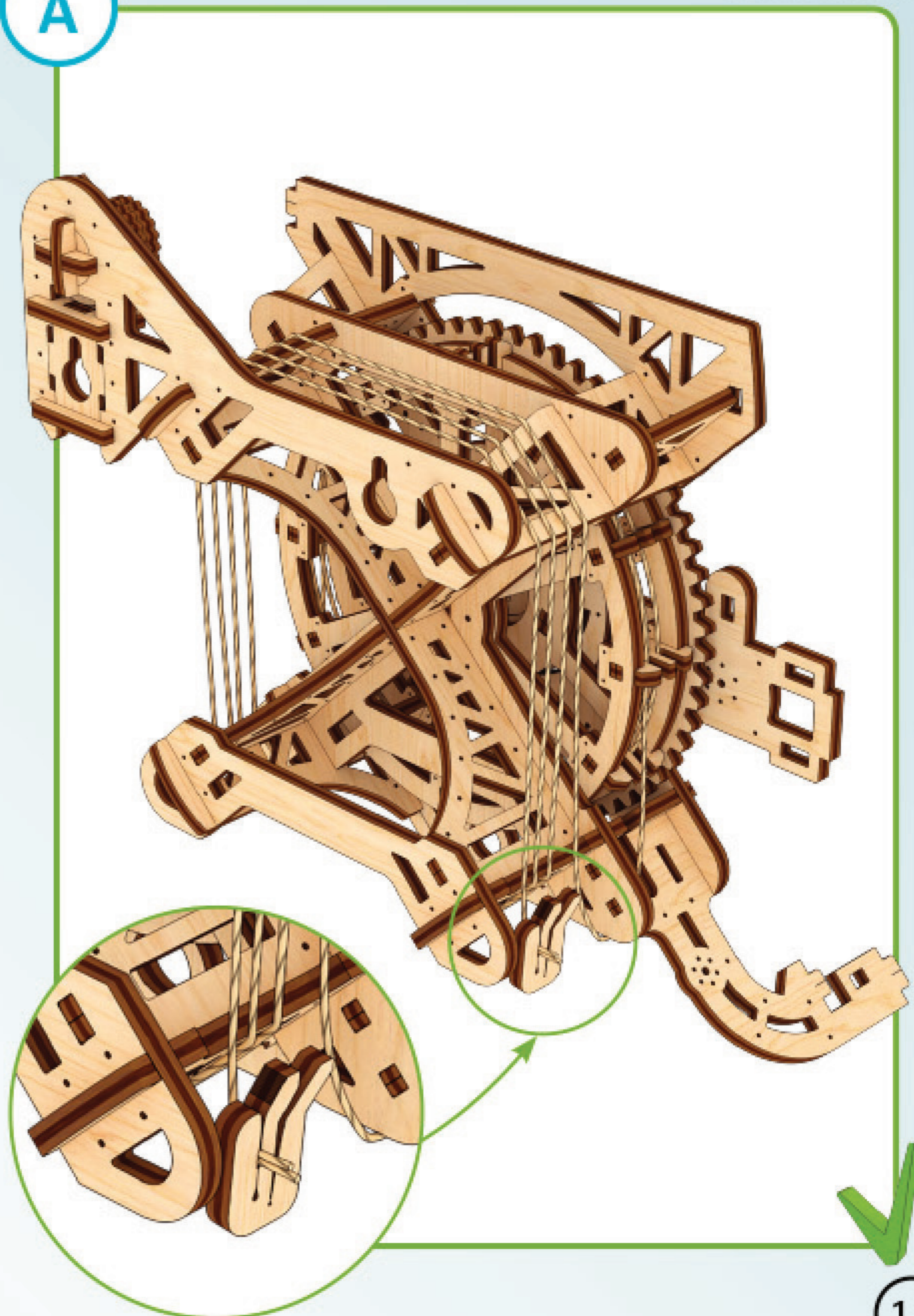

15

Mechanical models

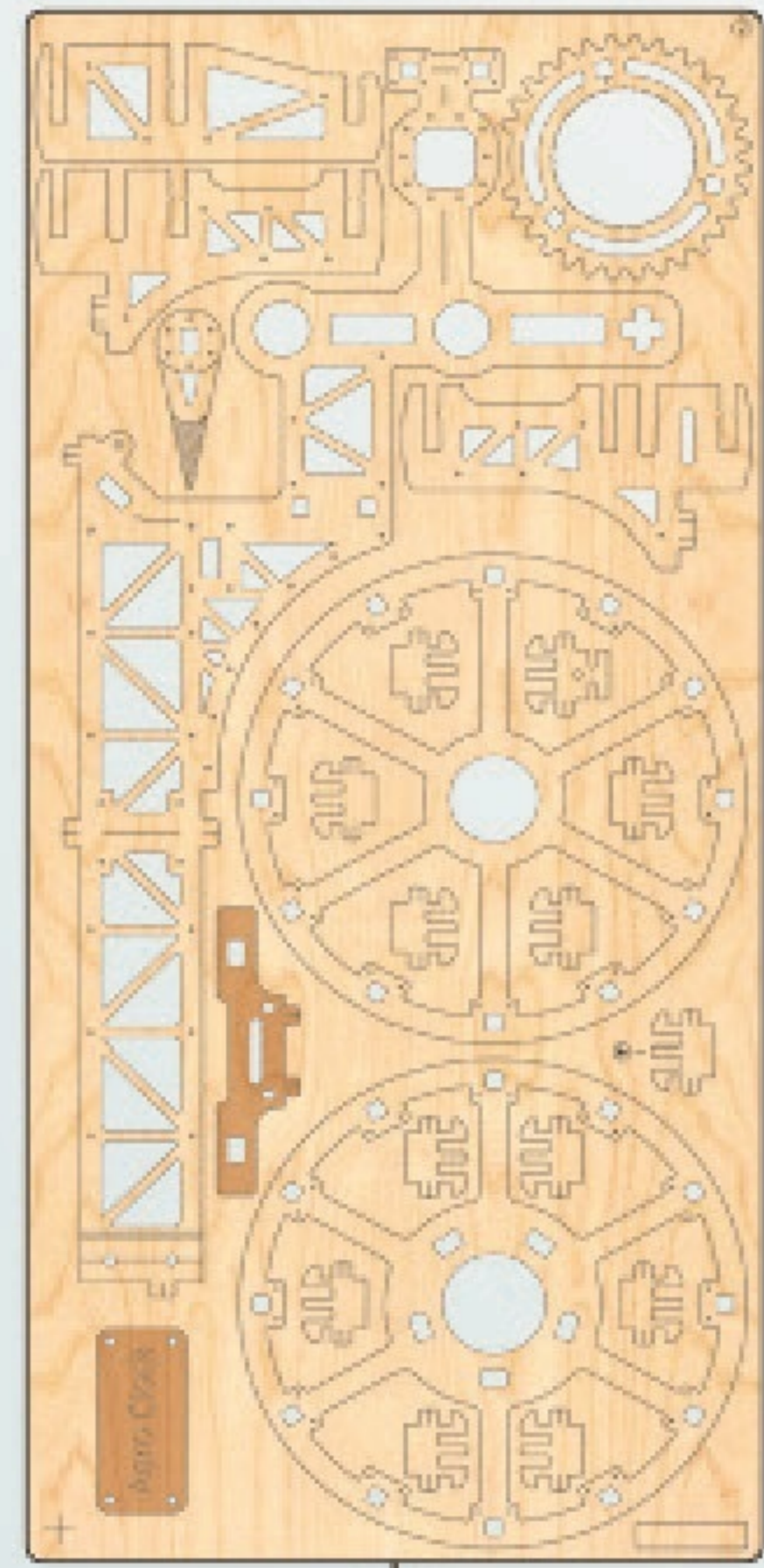

2

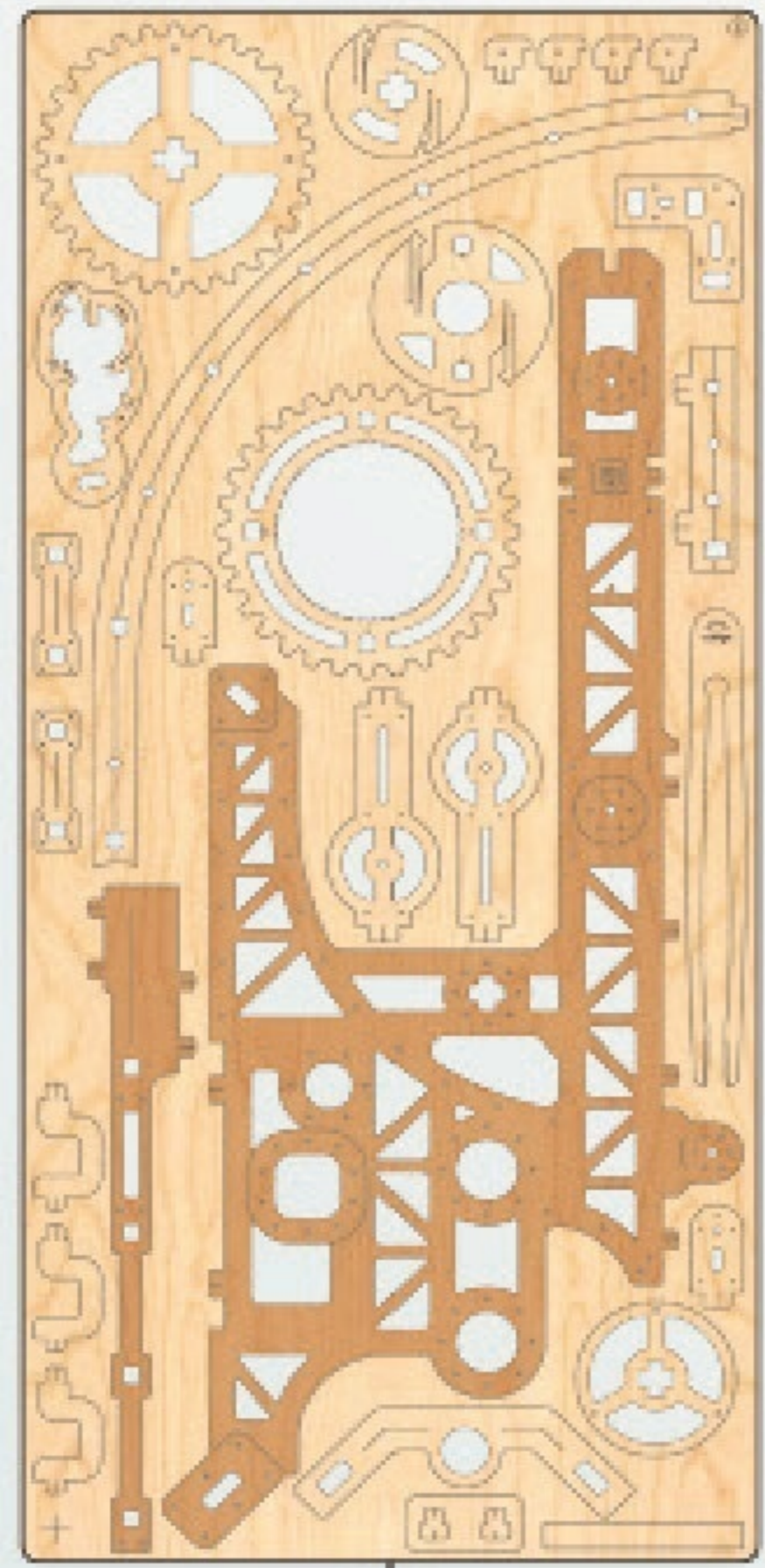

4

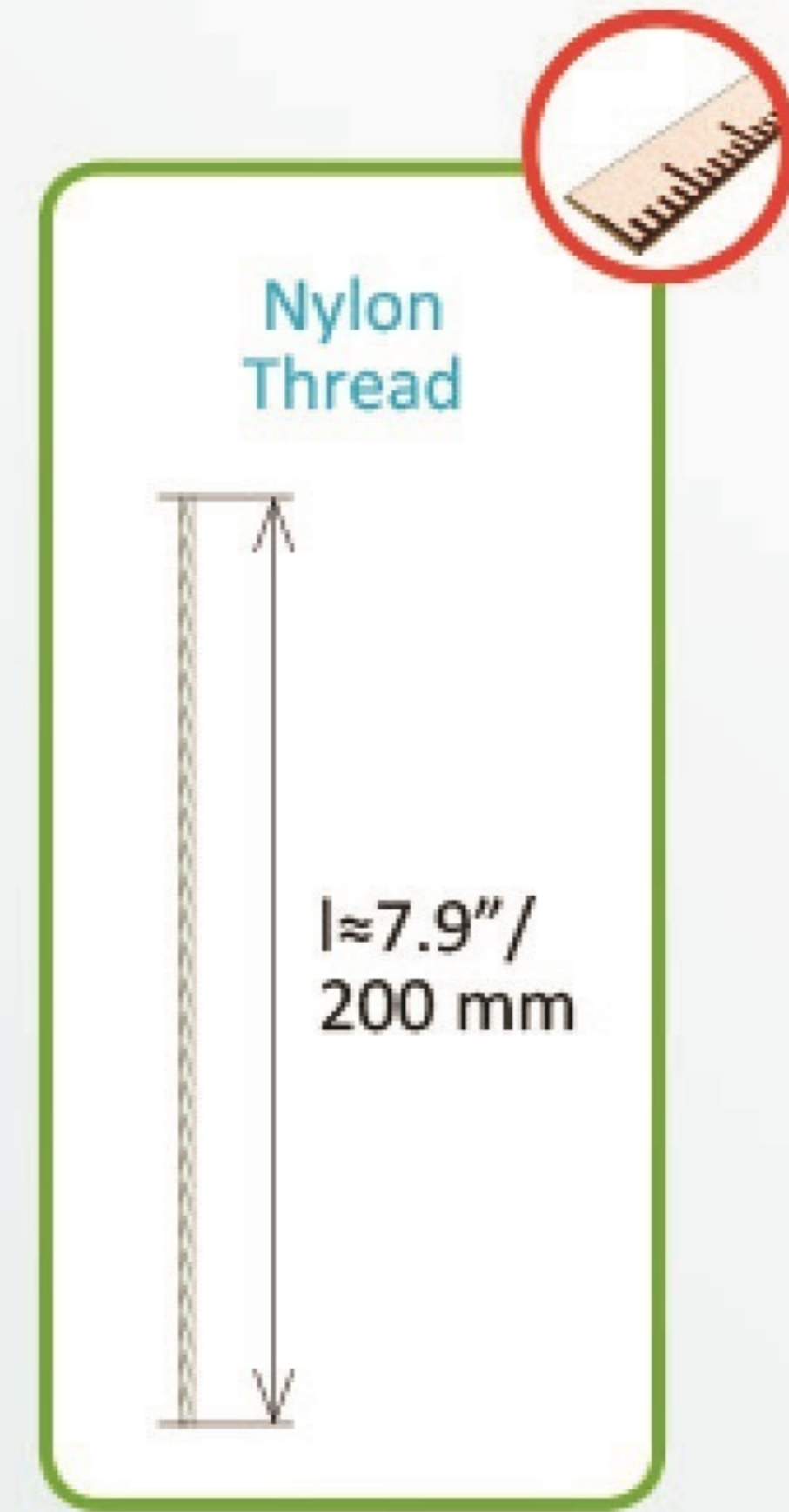

1



2



3

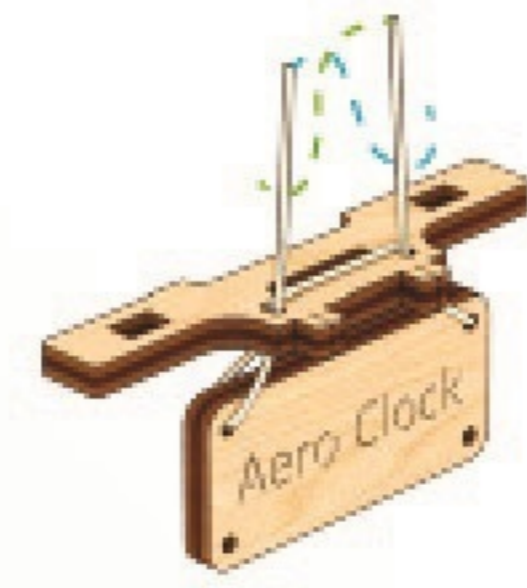

4

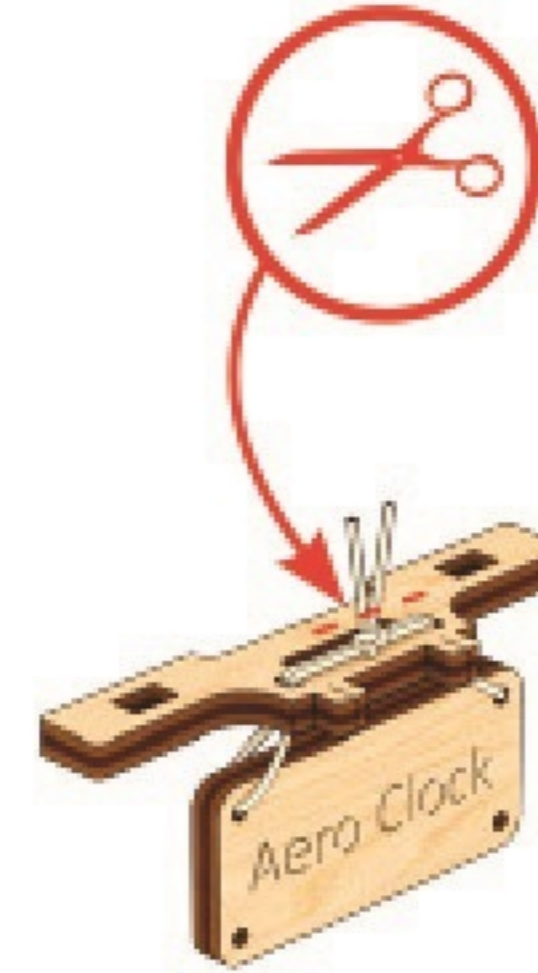

5

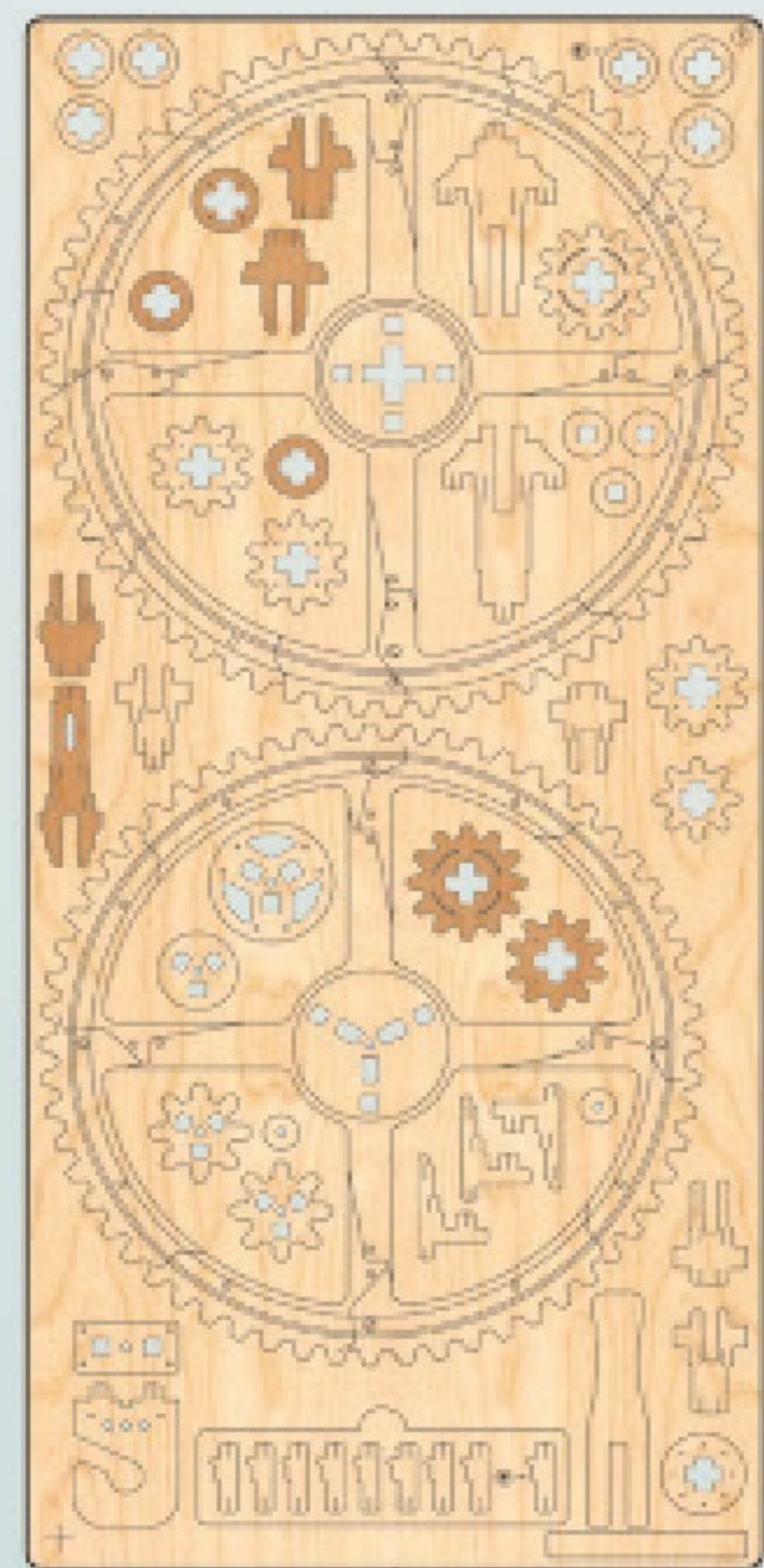
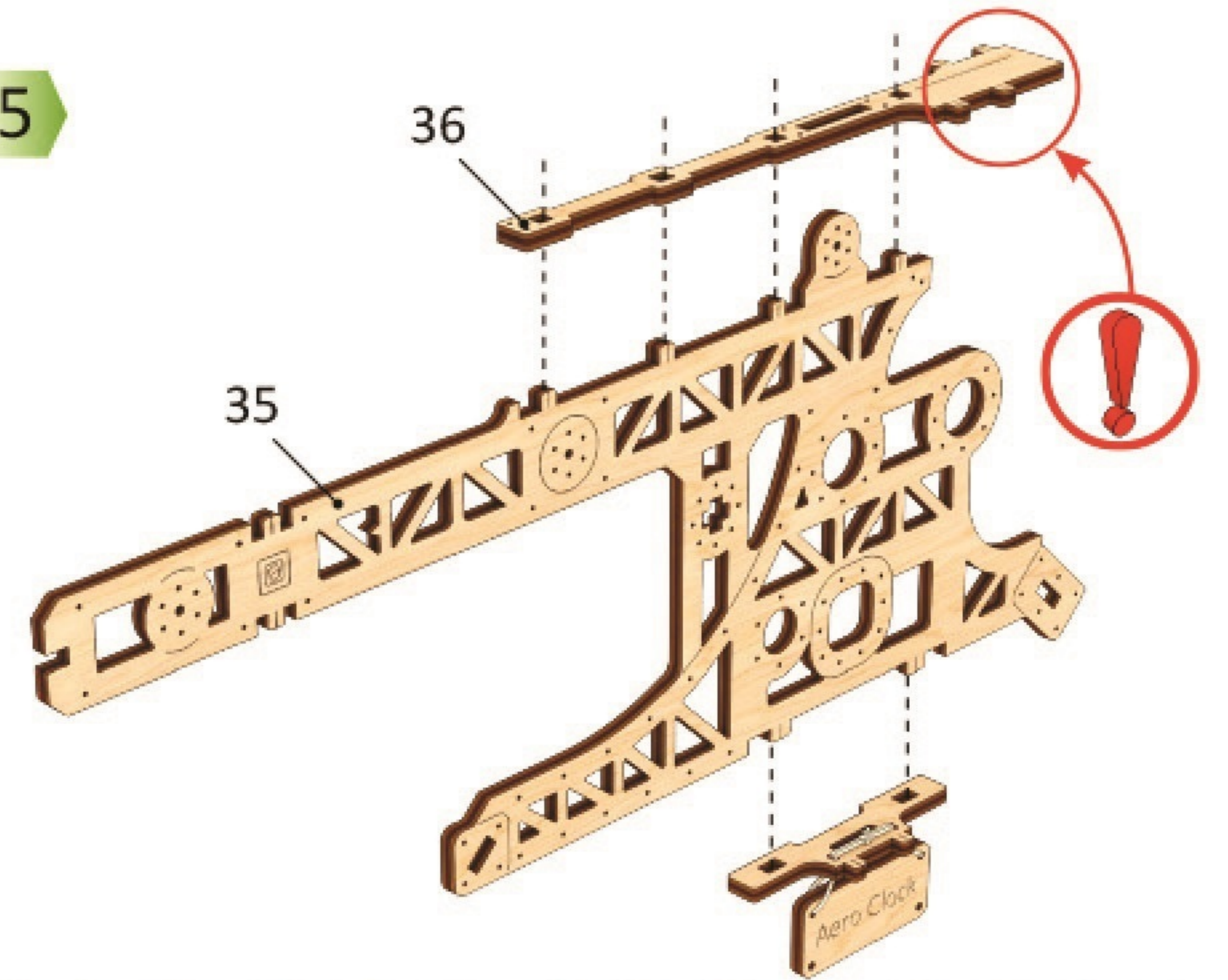

5

6

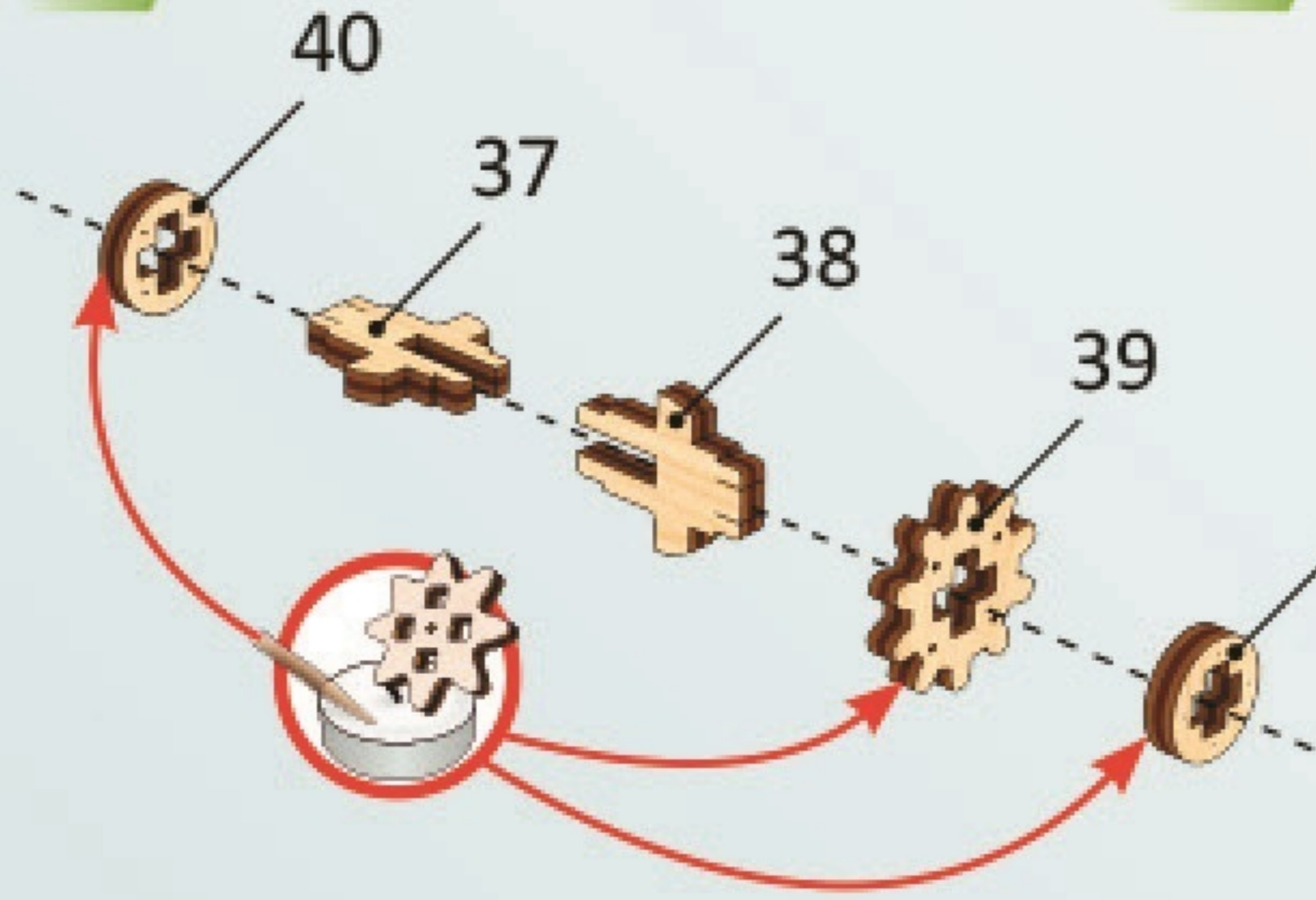

7

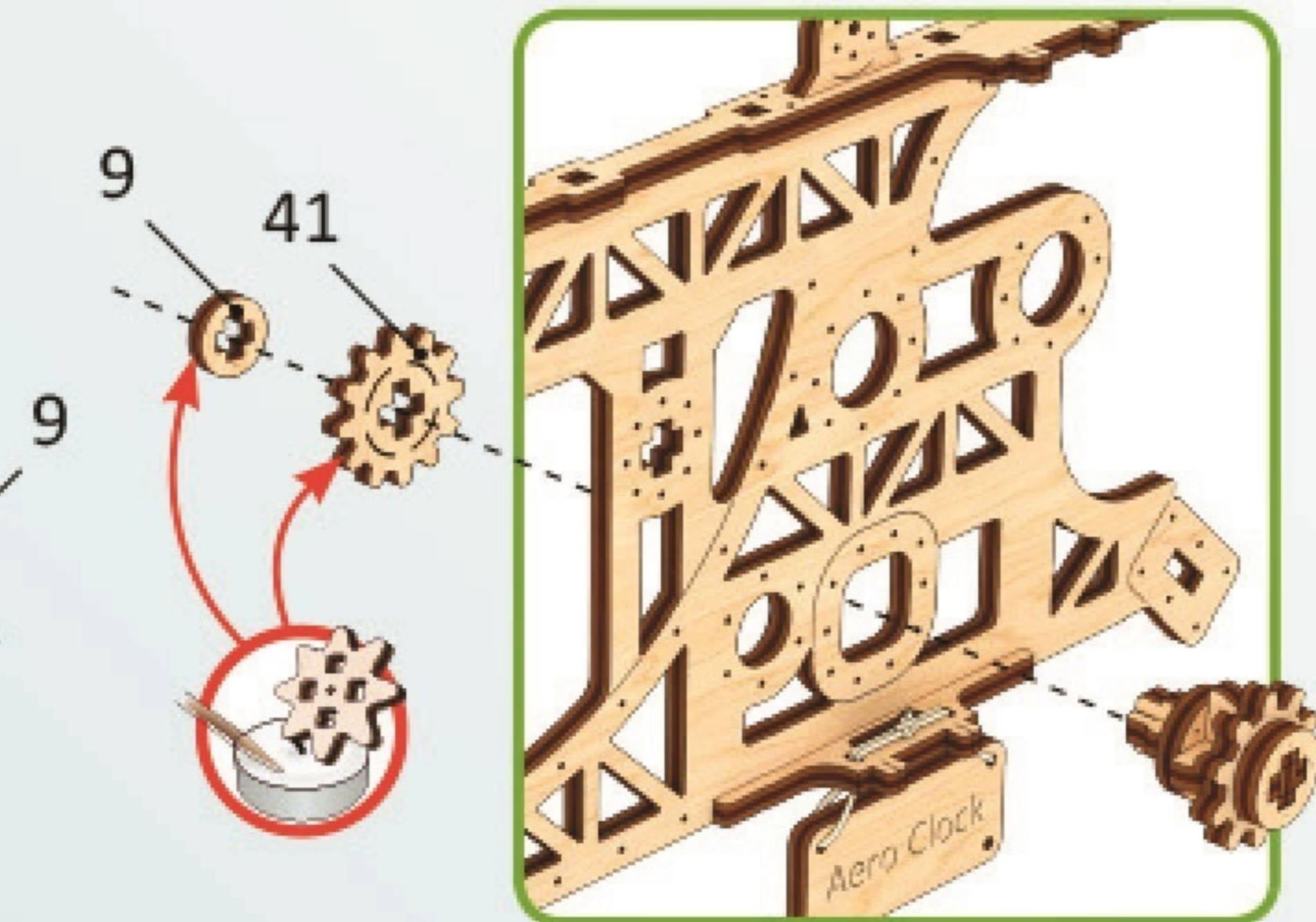

8

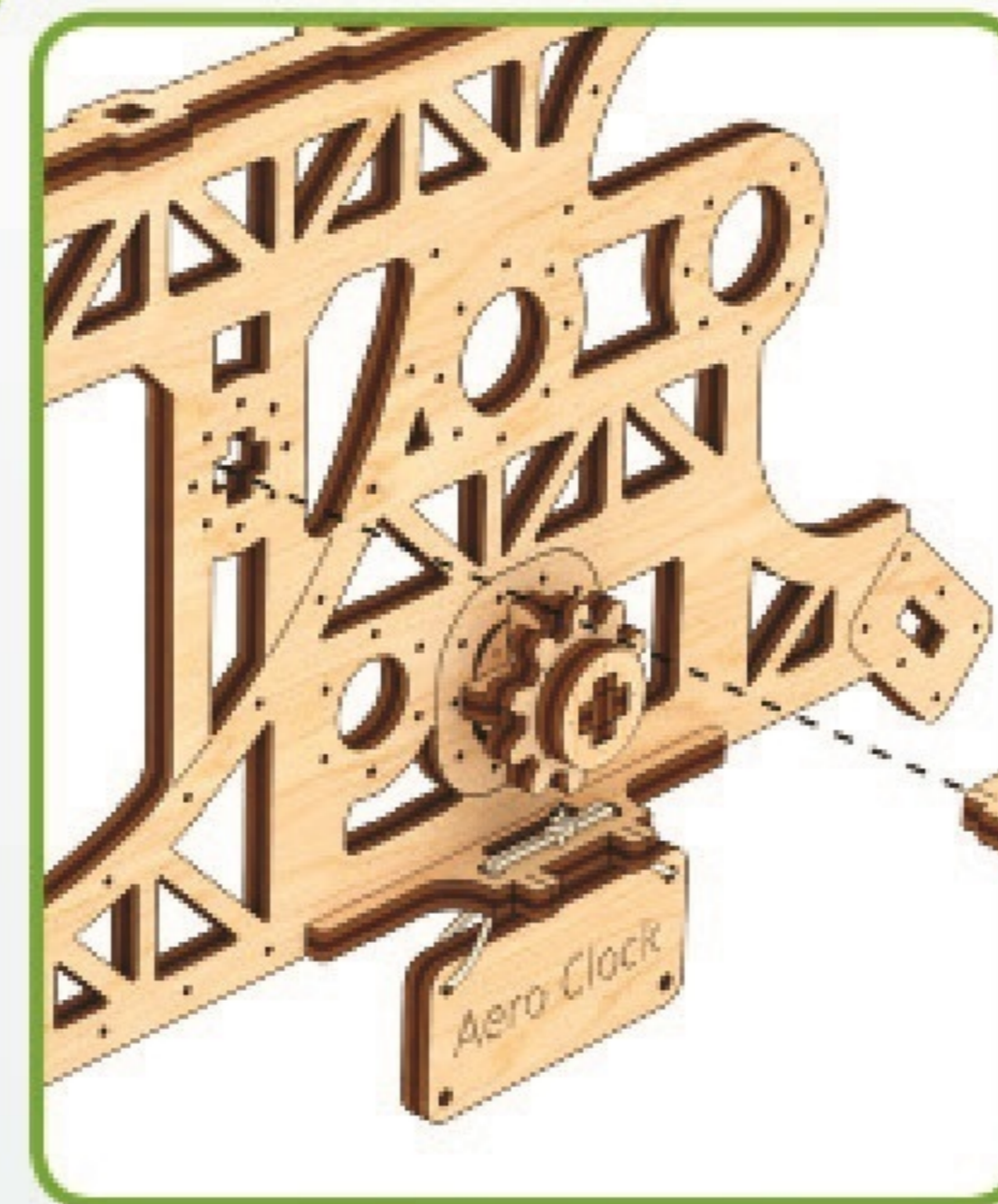

b1

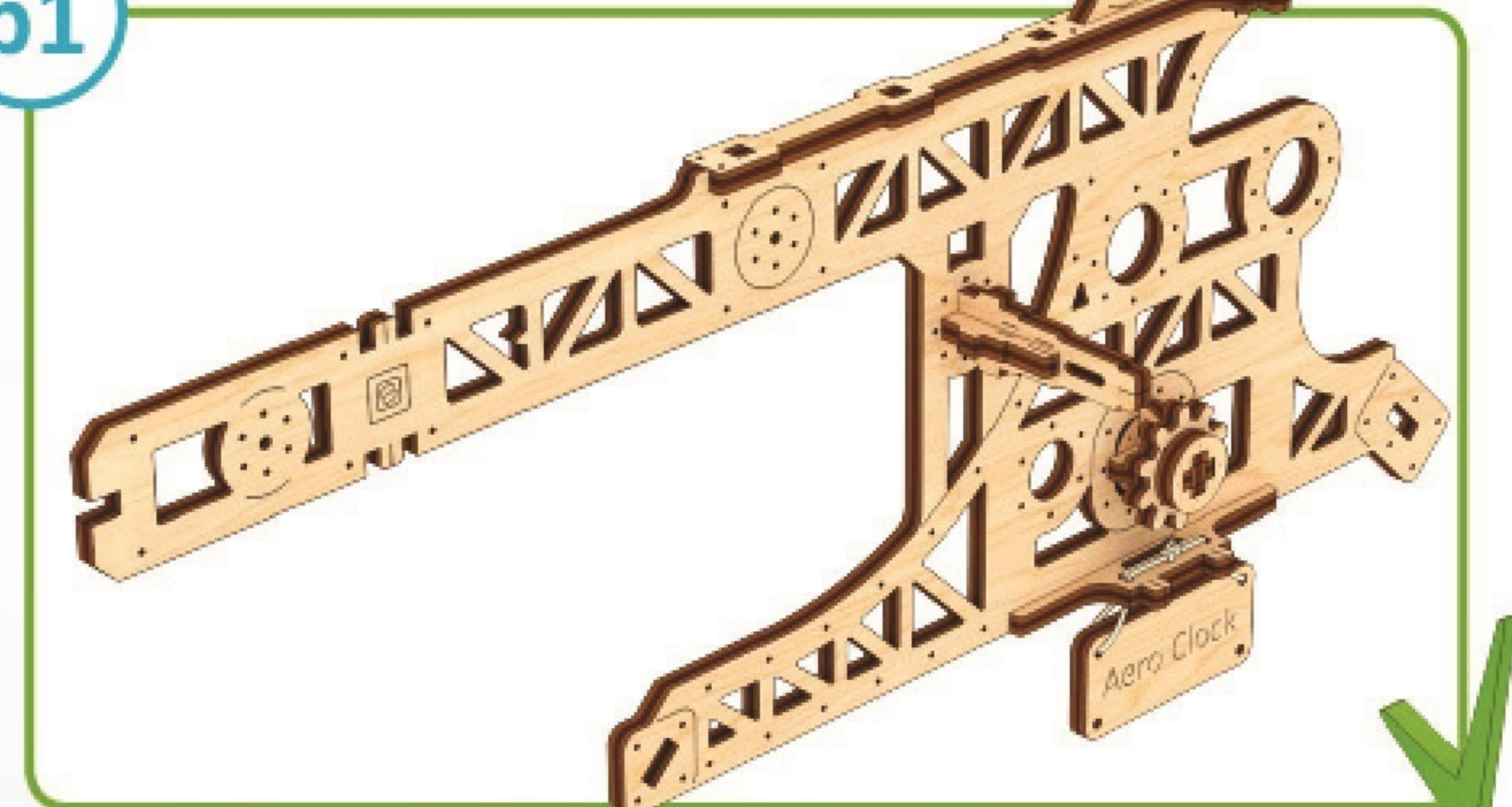



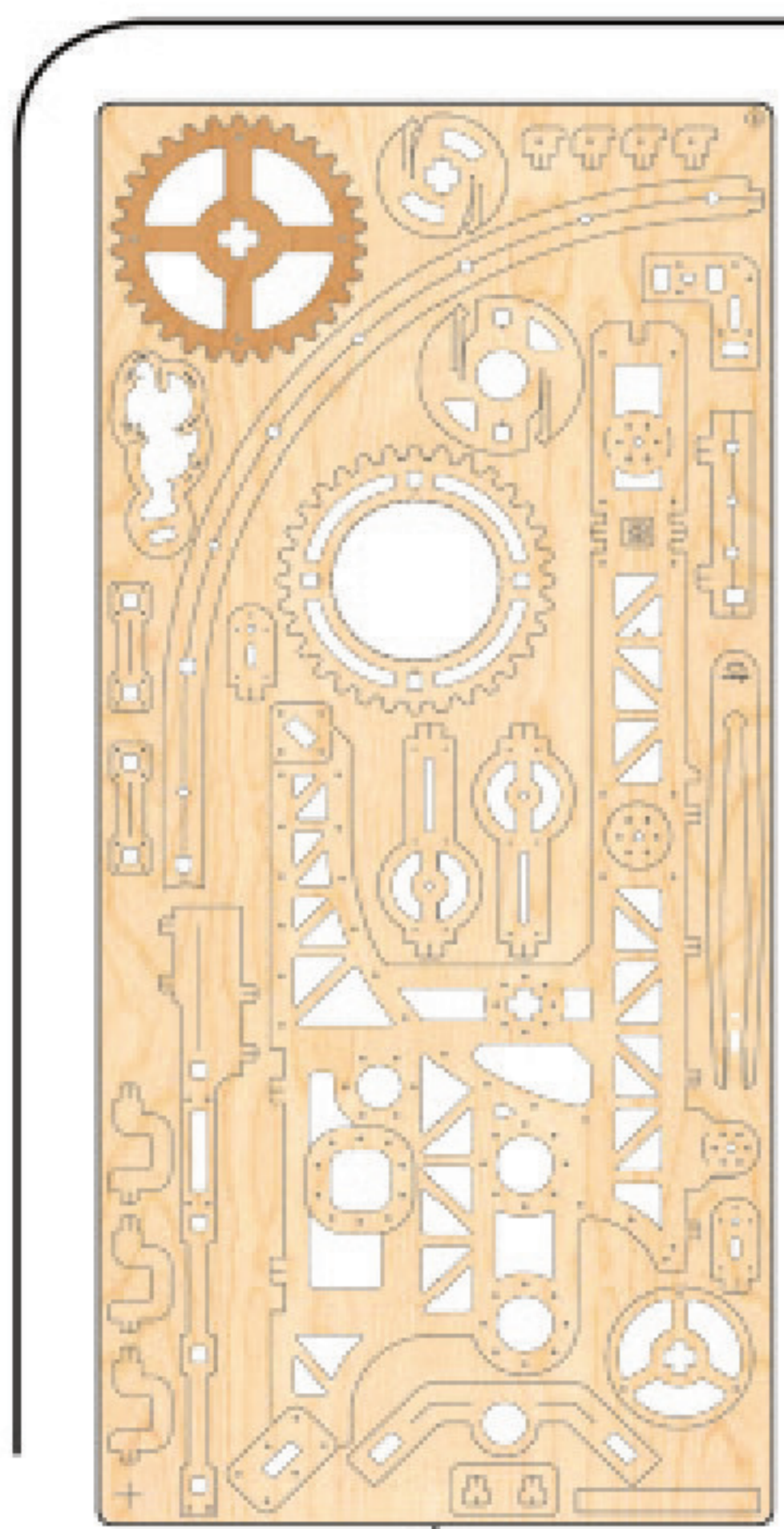

4

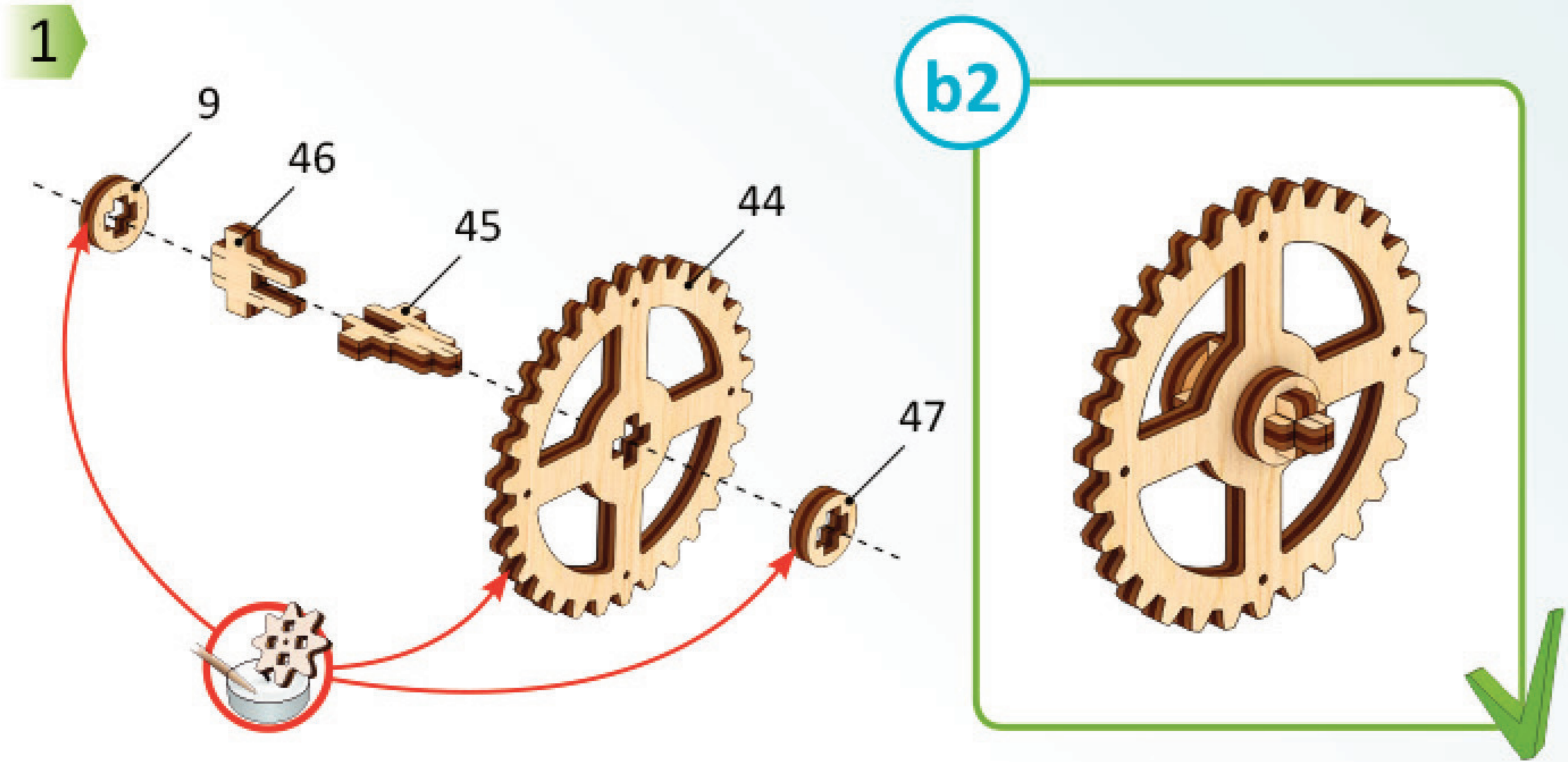

5

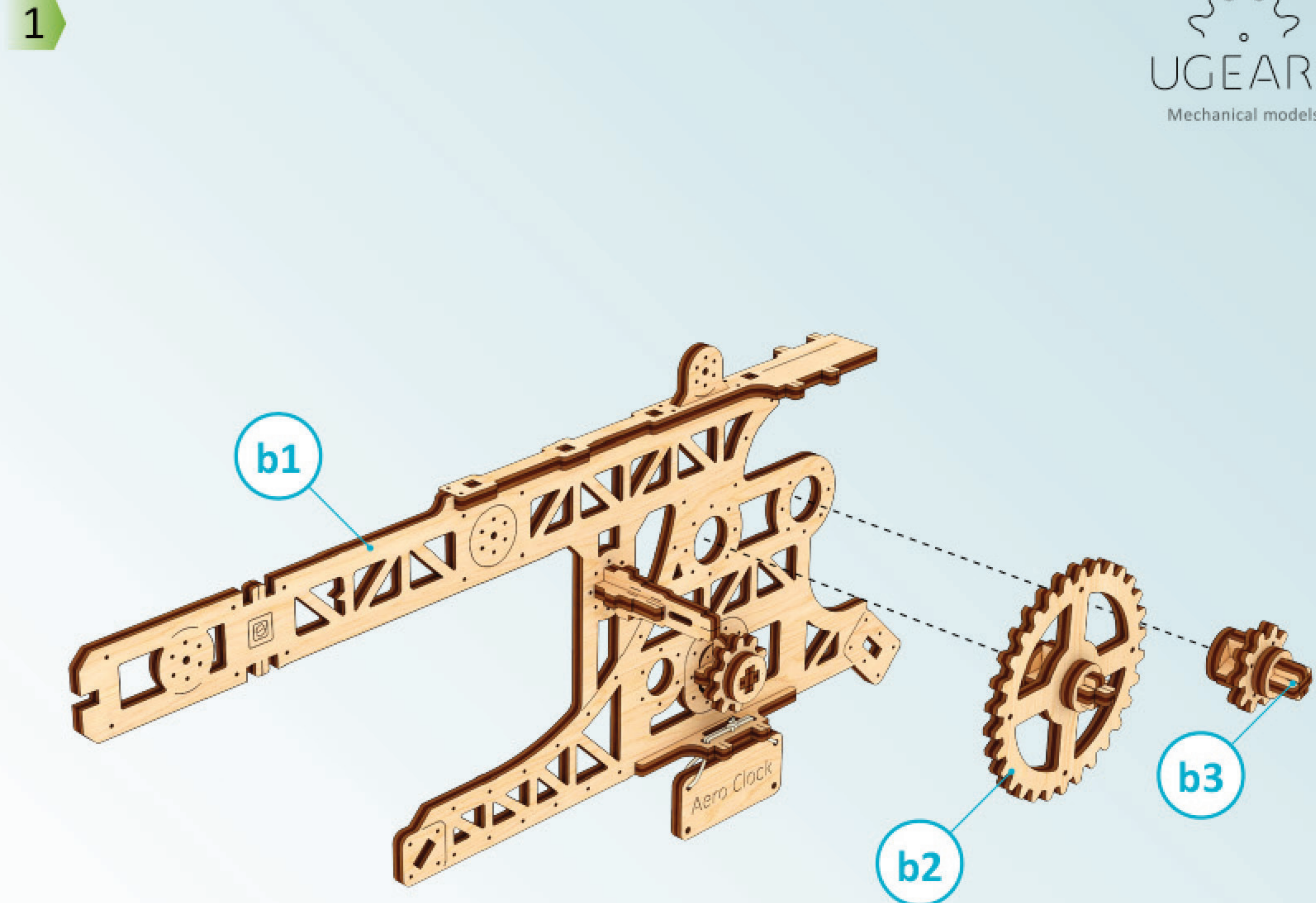
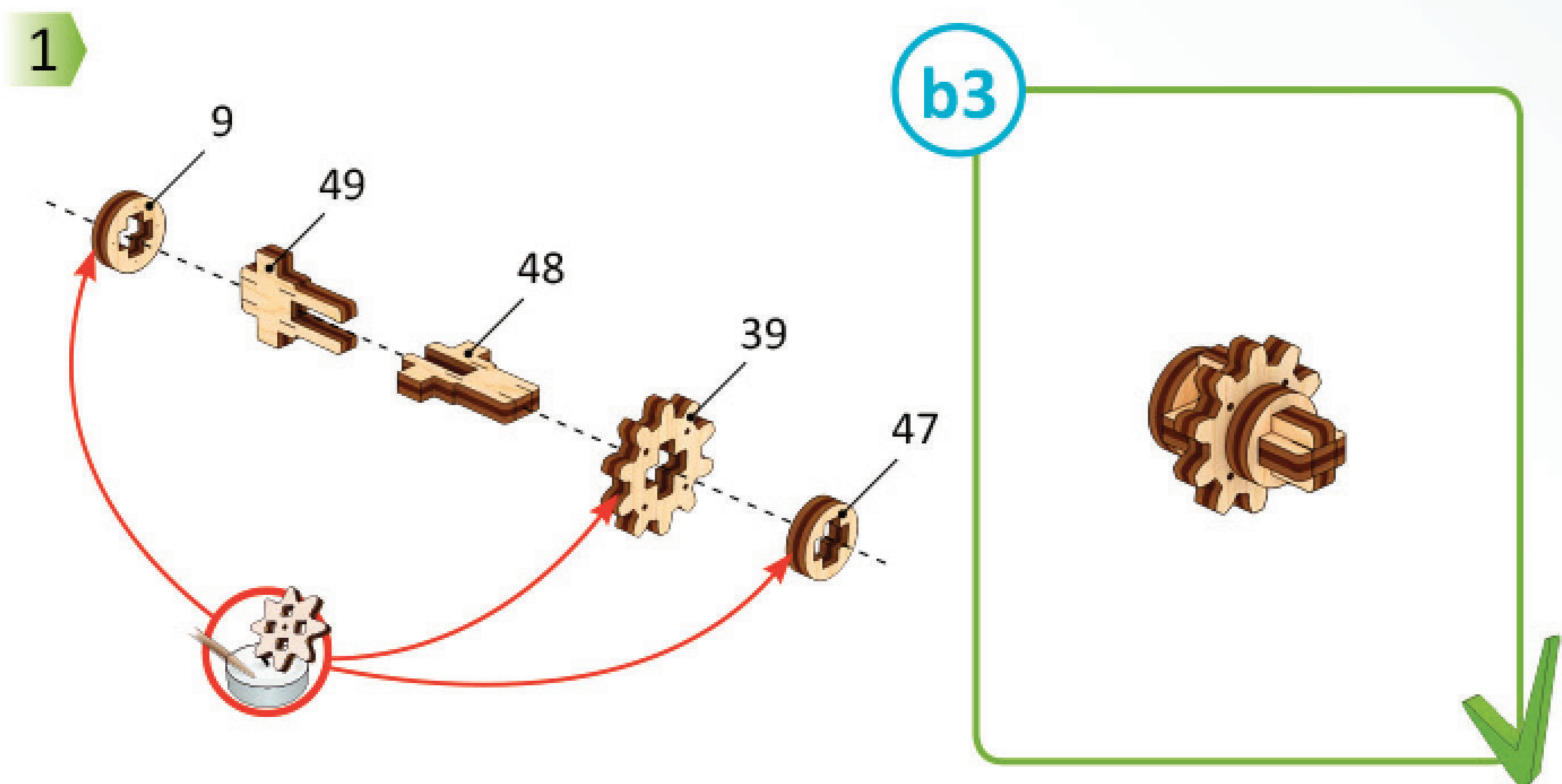

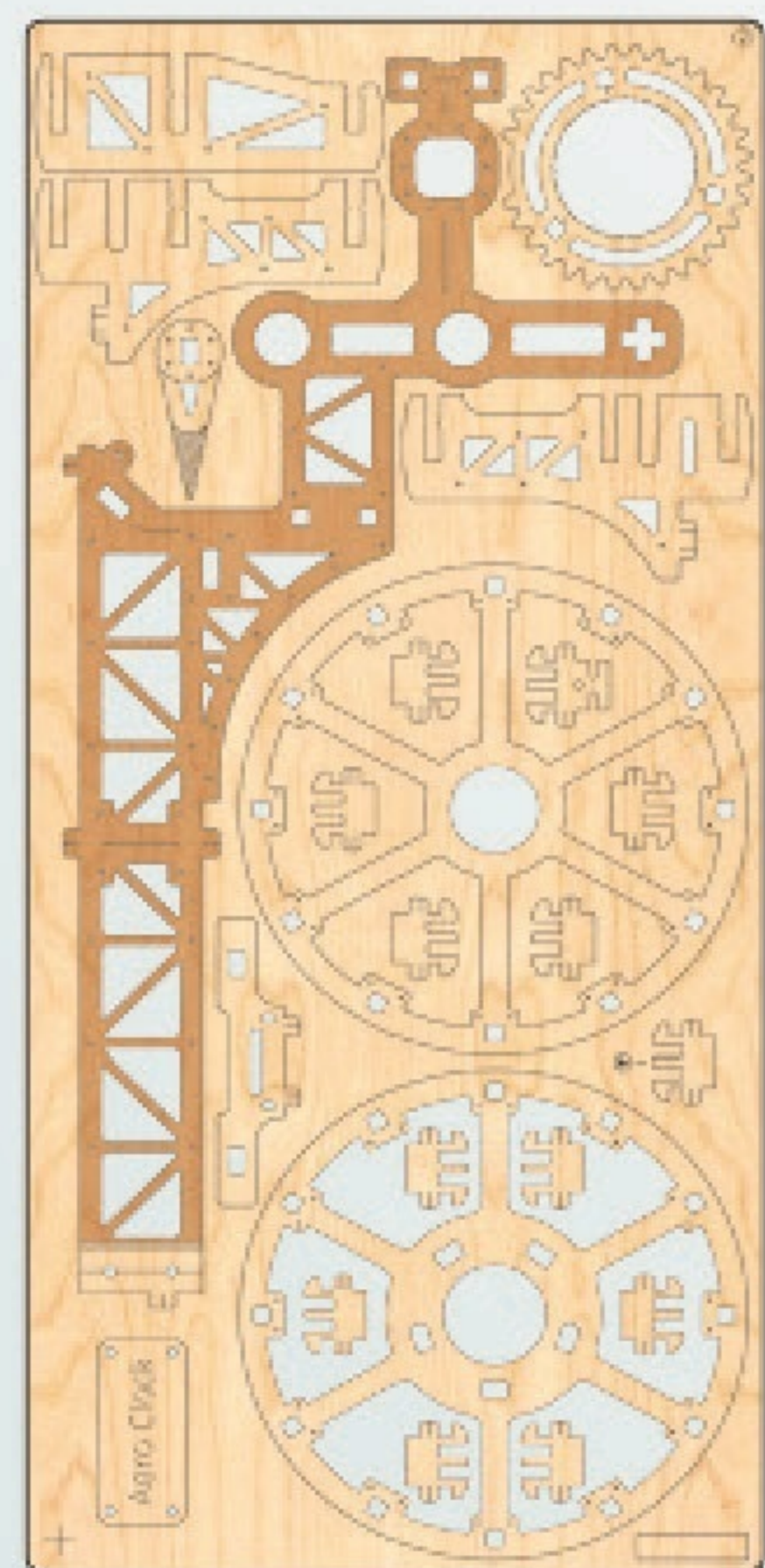

2

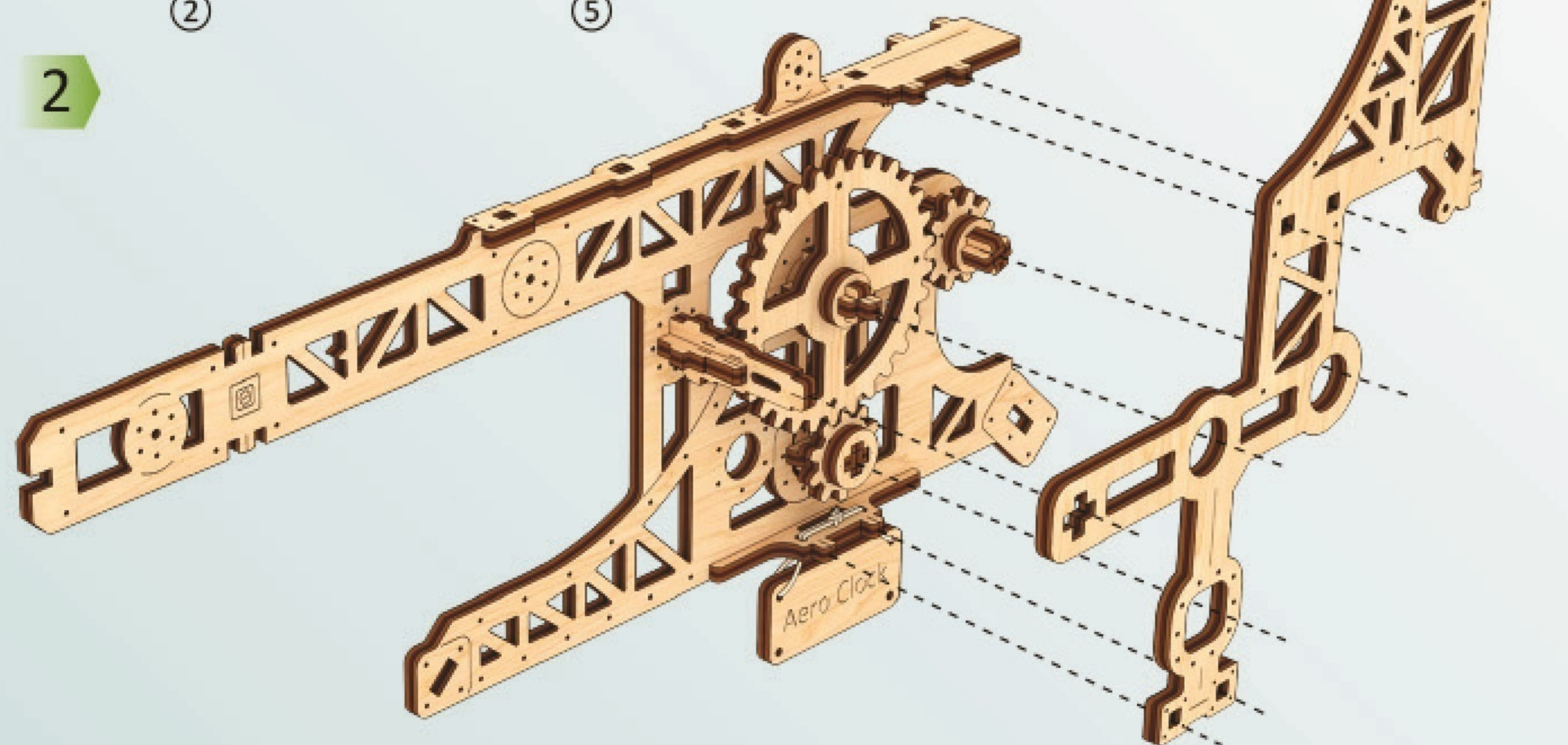

3

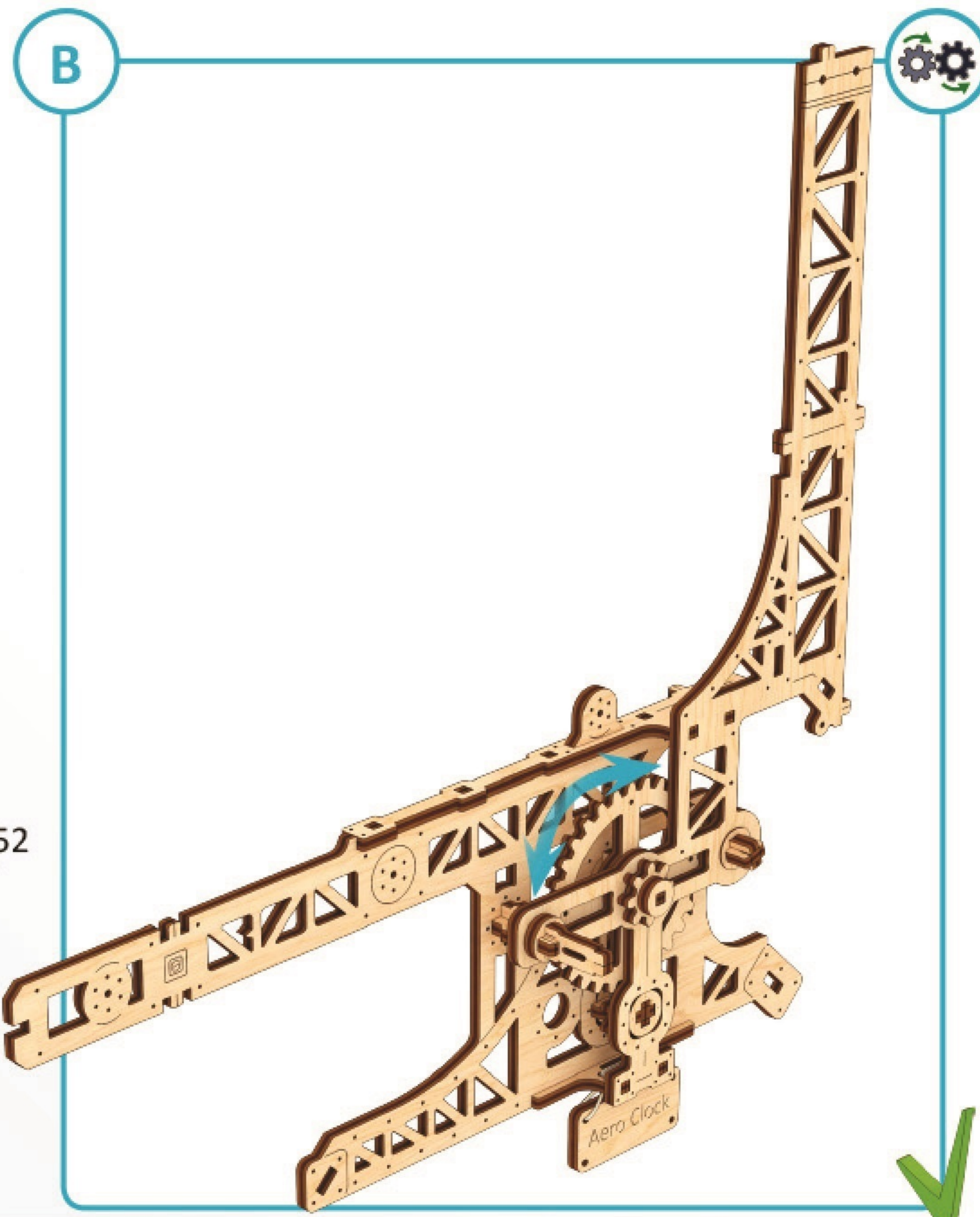
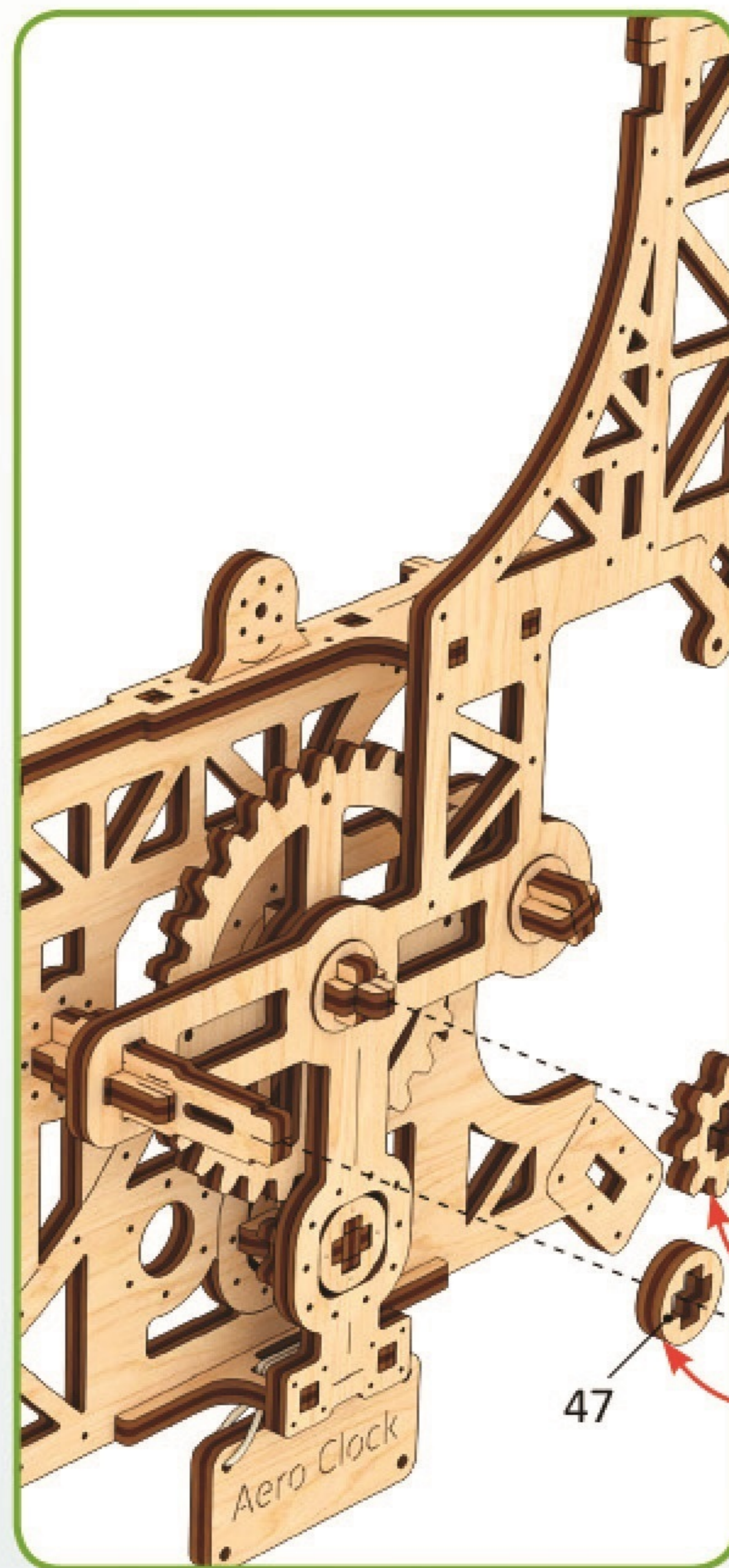

Controleer het mechanisme op een soepele en goede beweging. Breng het mechanisme in beweging om de onderdelen in positie te krijgen.

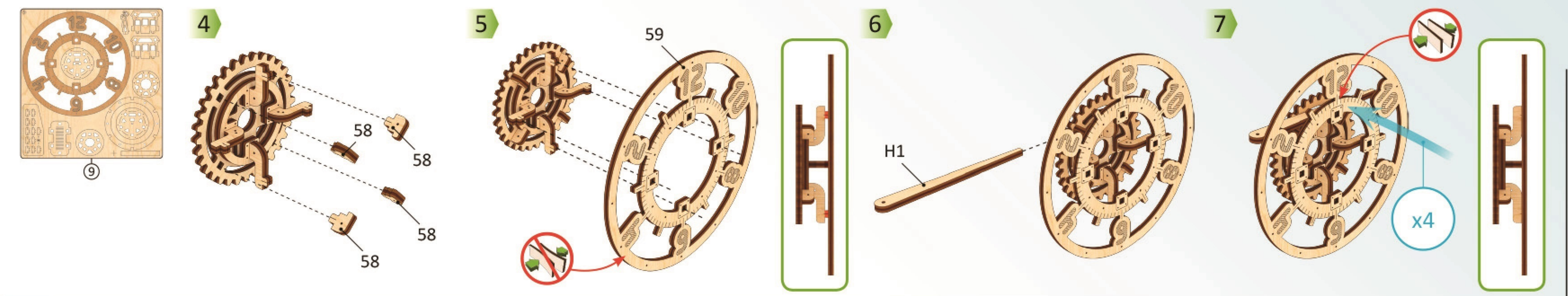
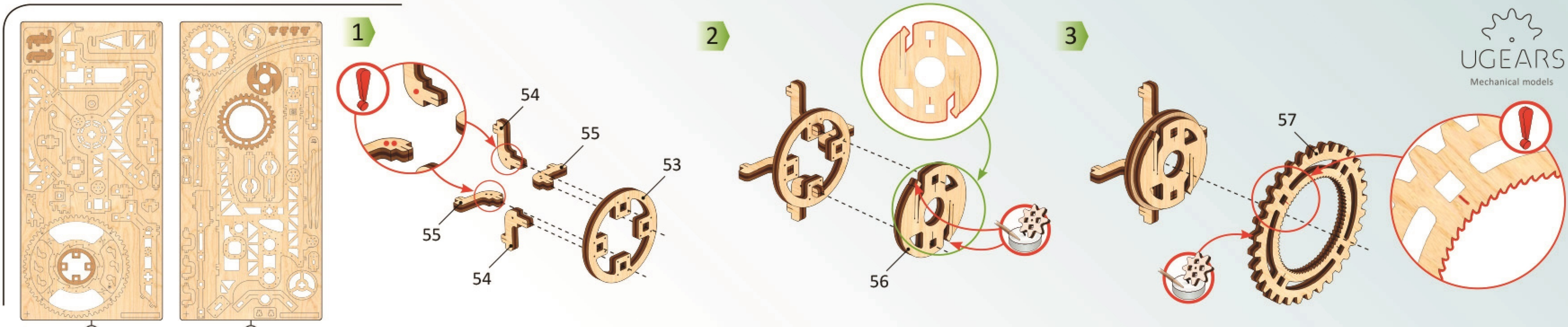

 Overtuig u ervan dat de onderdelen goed zijn uitgelijnd met de andere onderdelen voor u ze goed aandrukt.

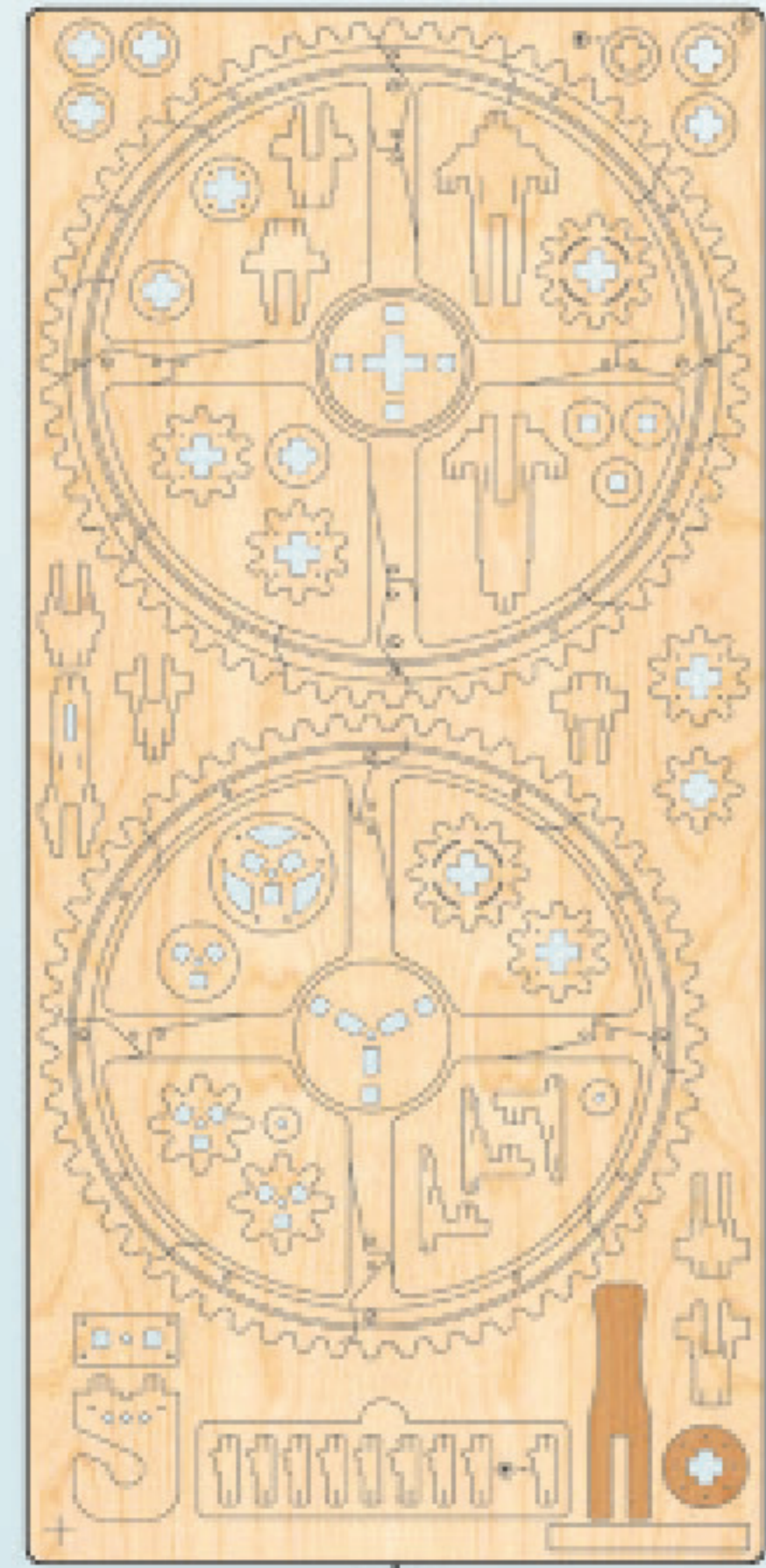

8

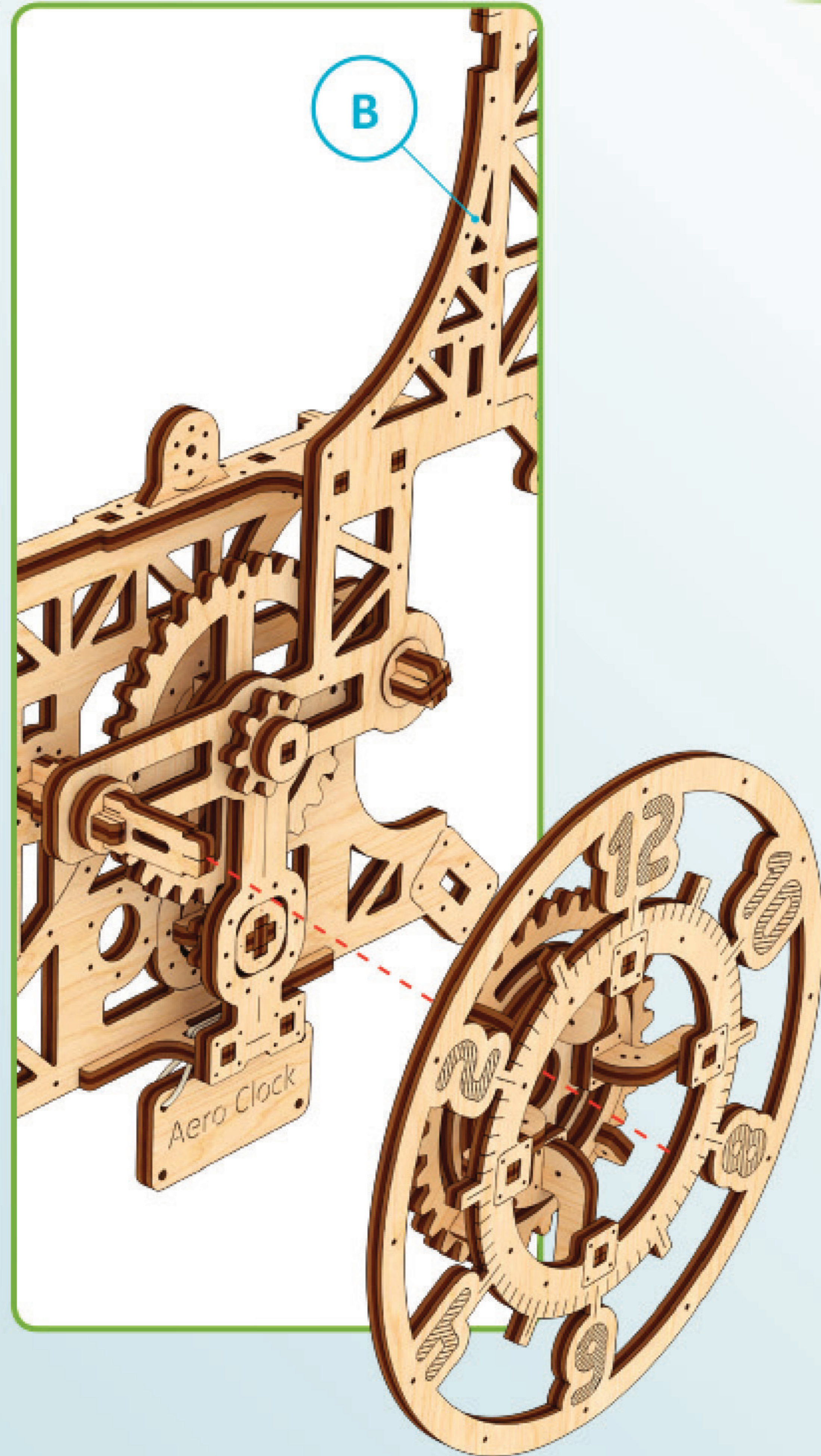

9



10



11

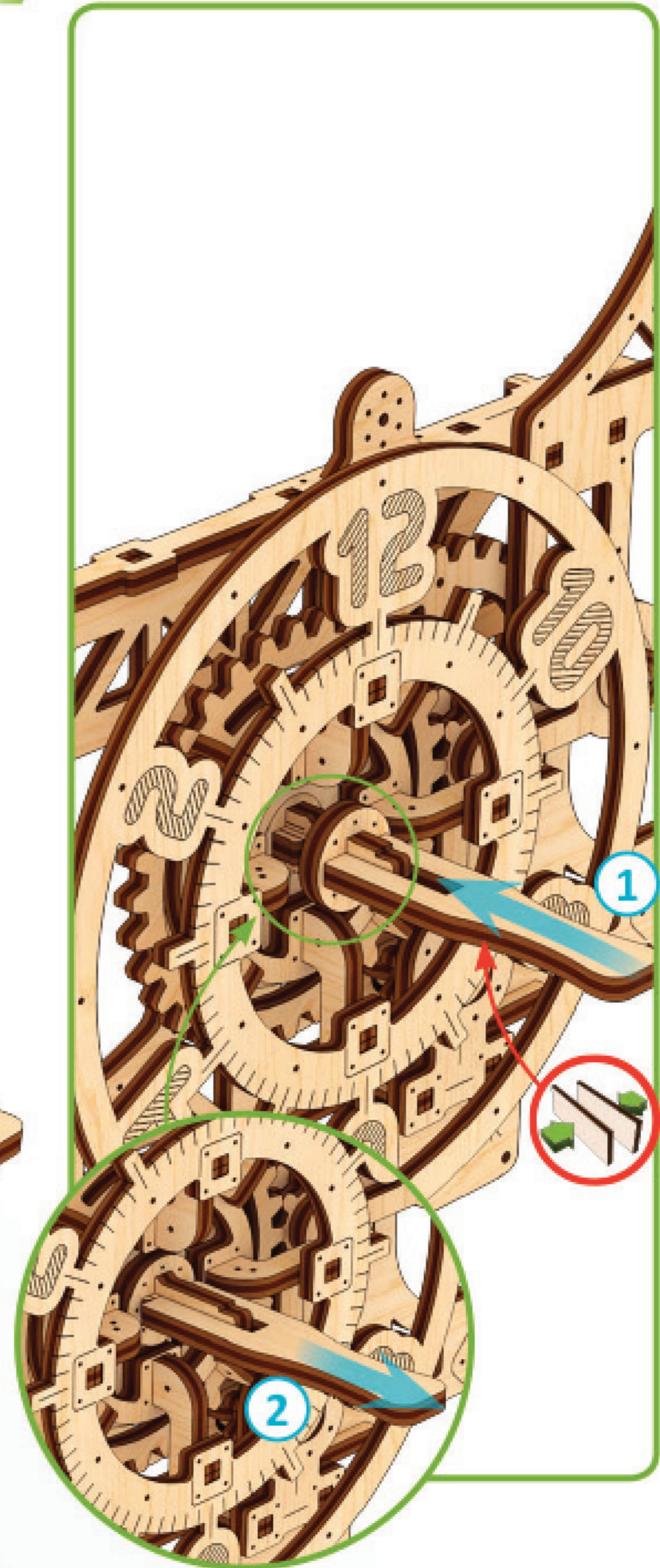

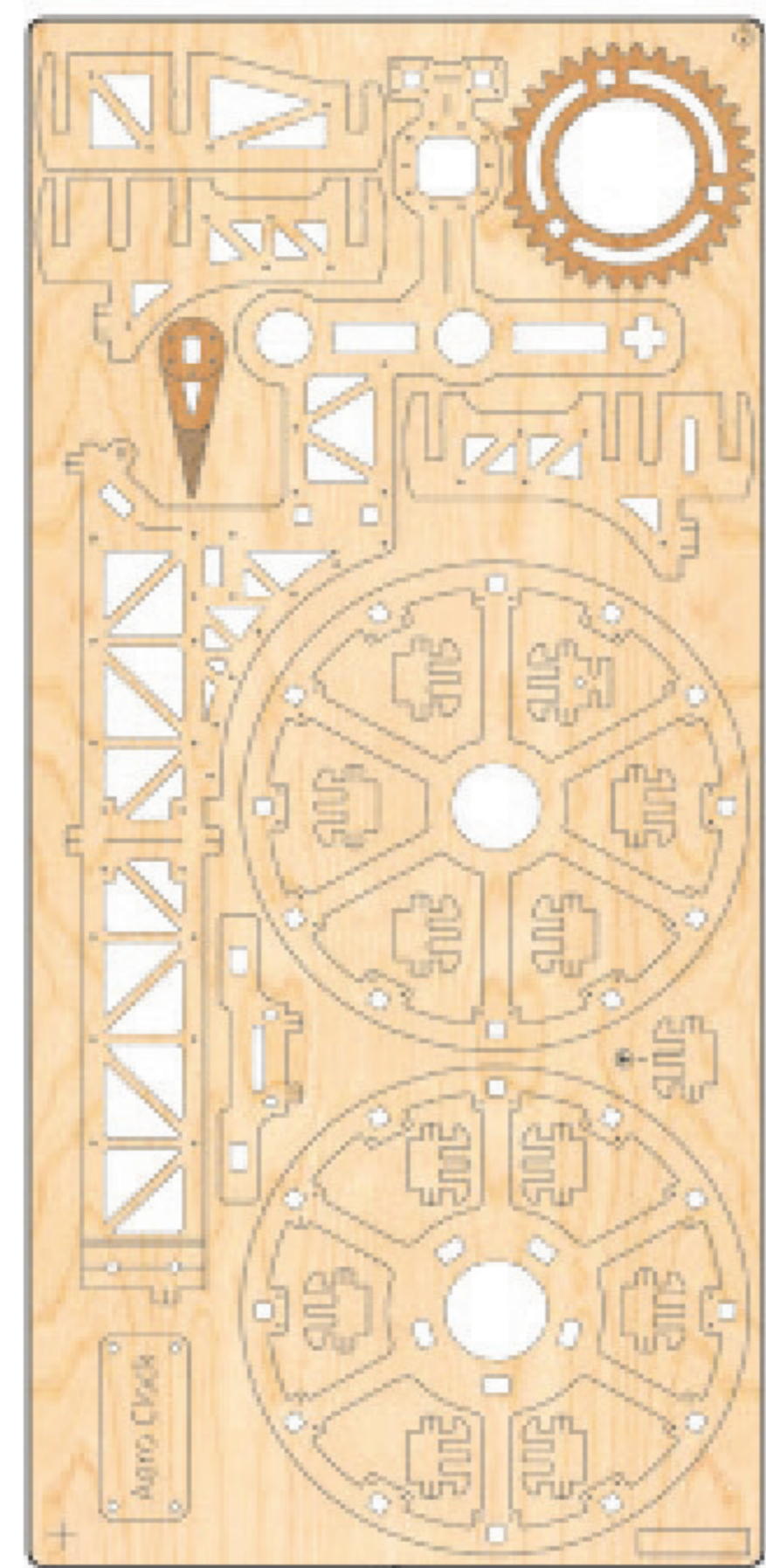

2

12

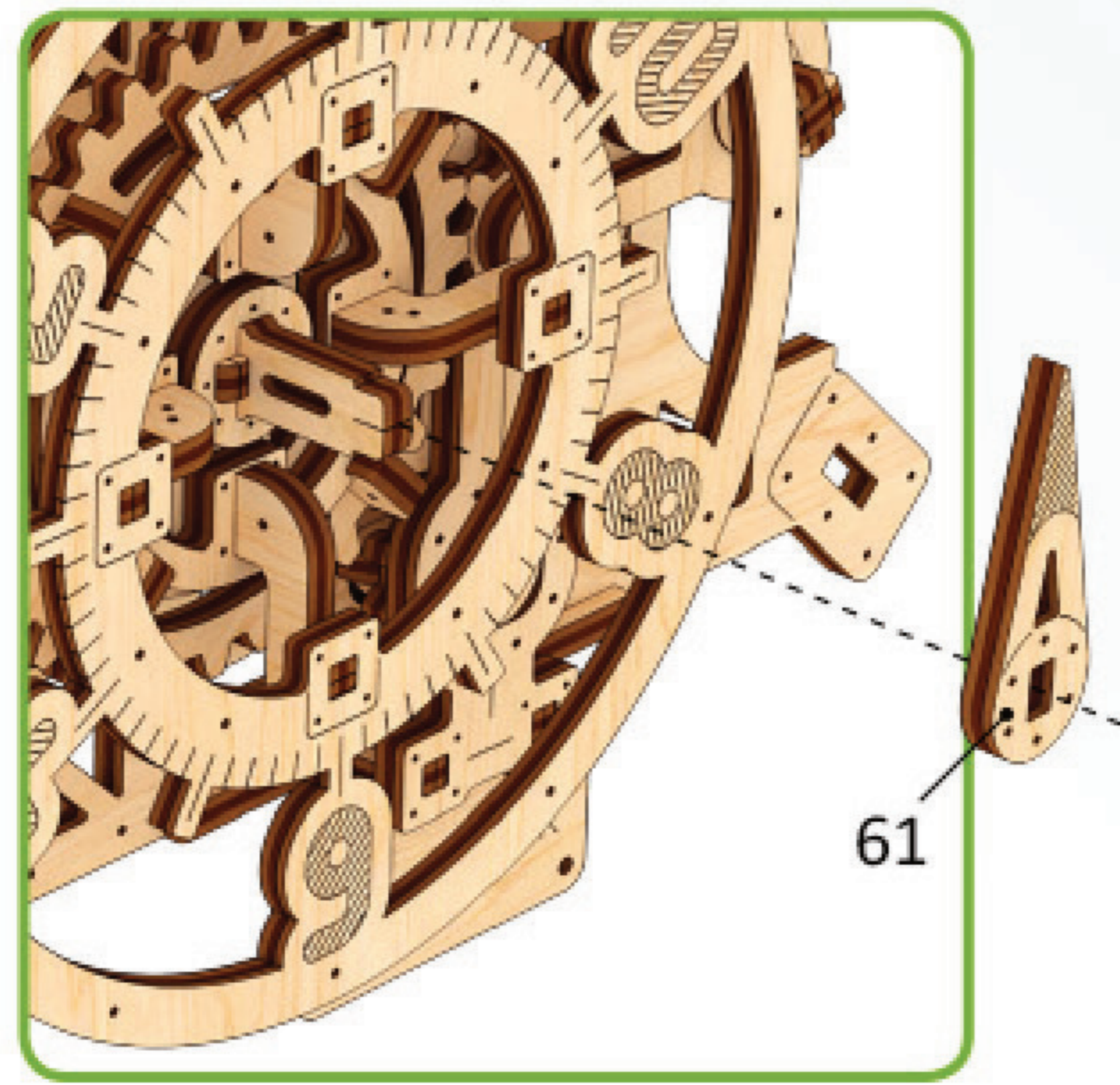

13

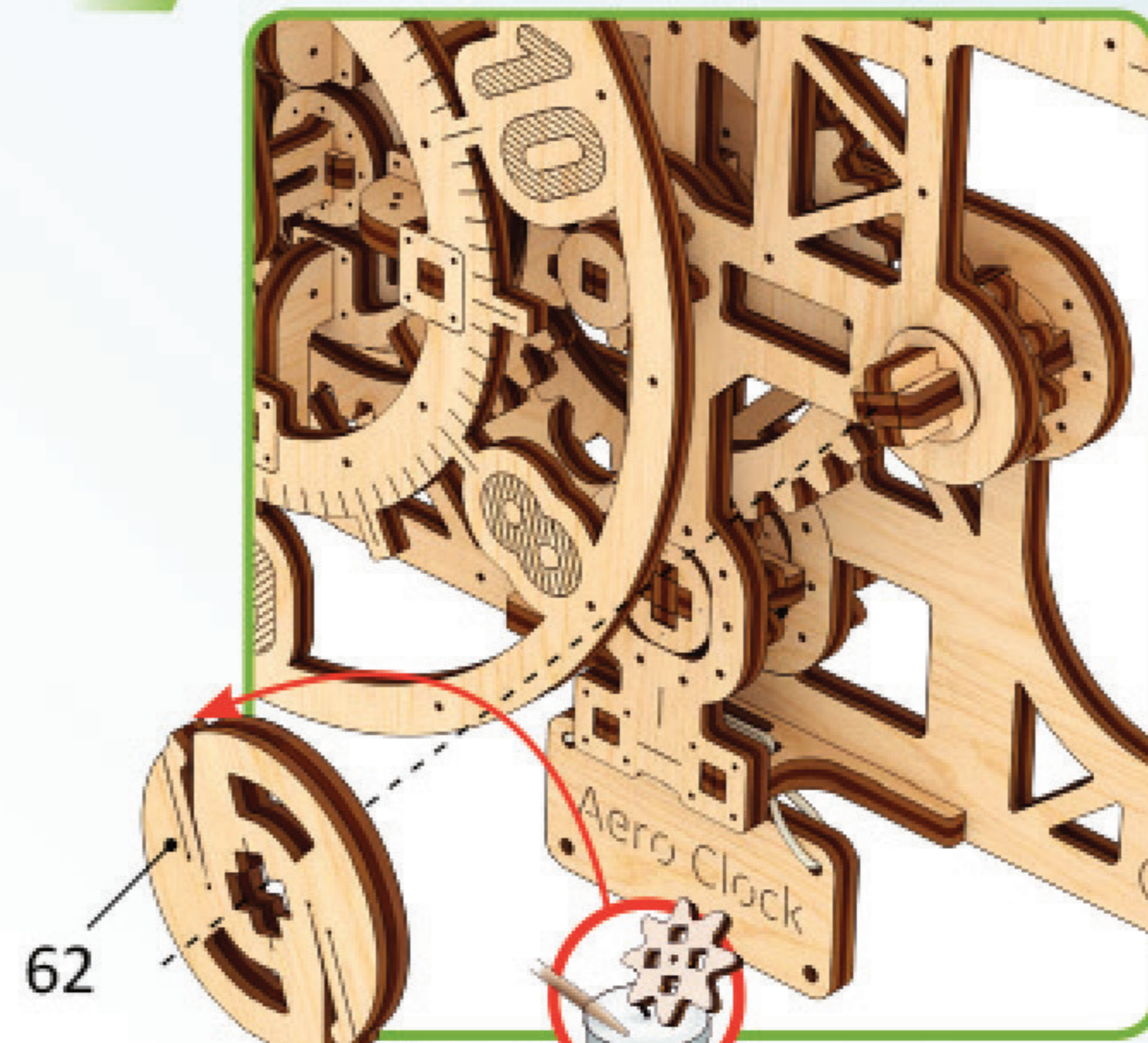

14

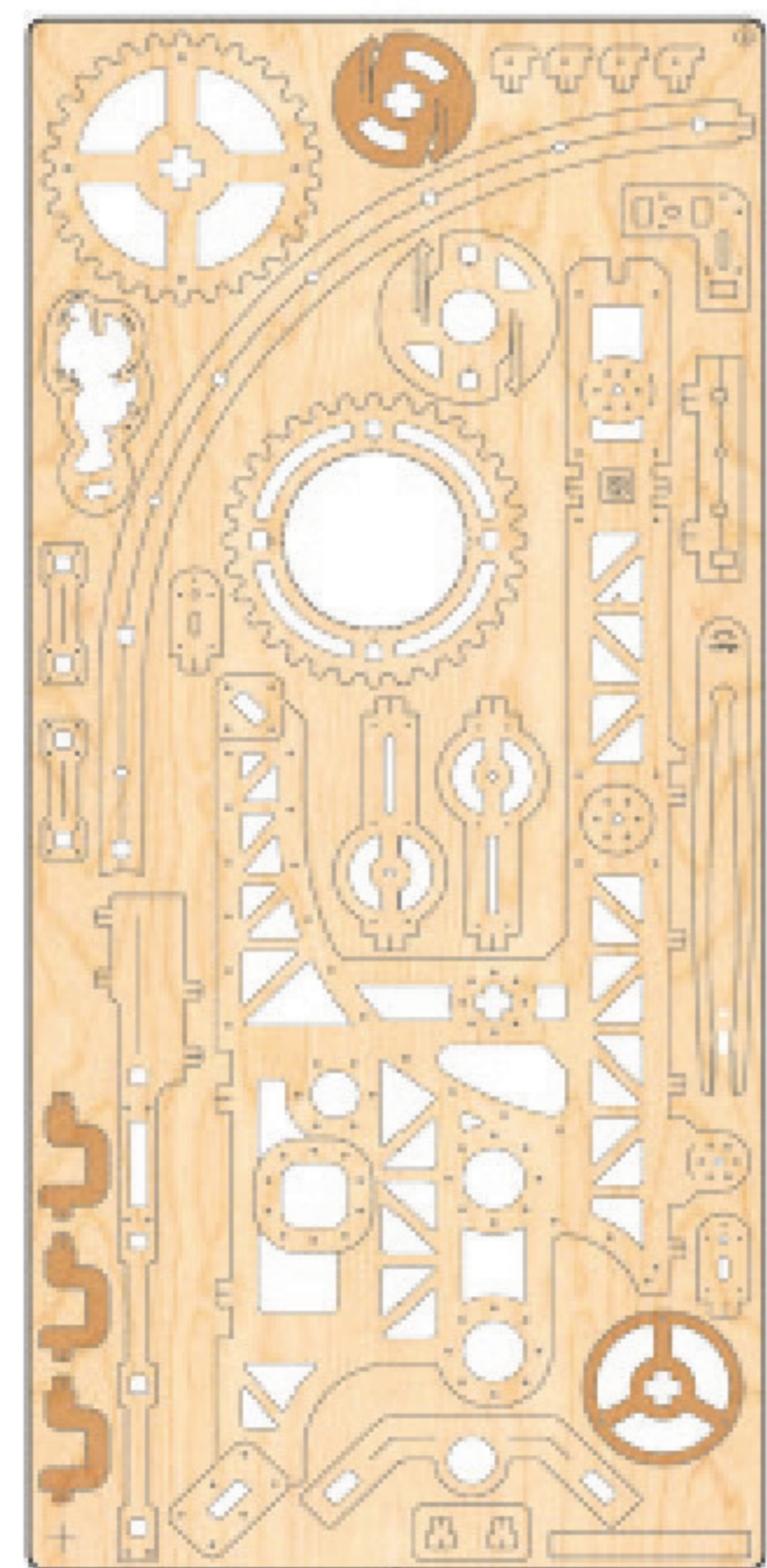
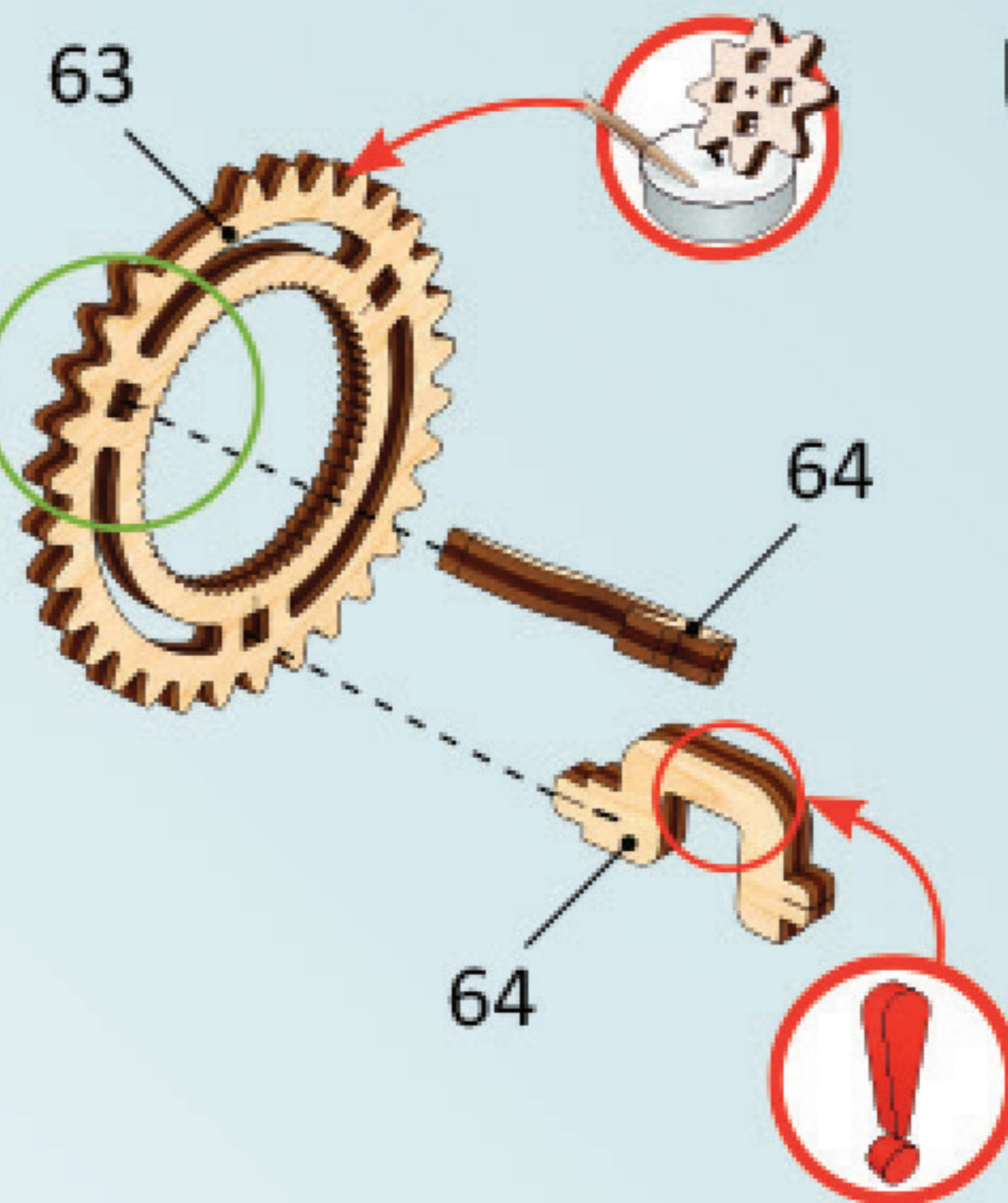
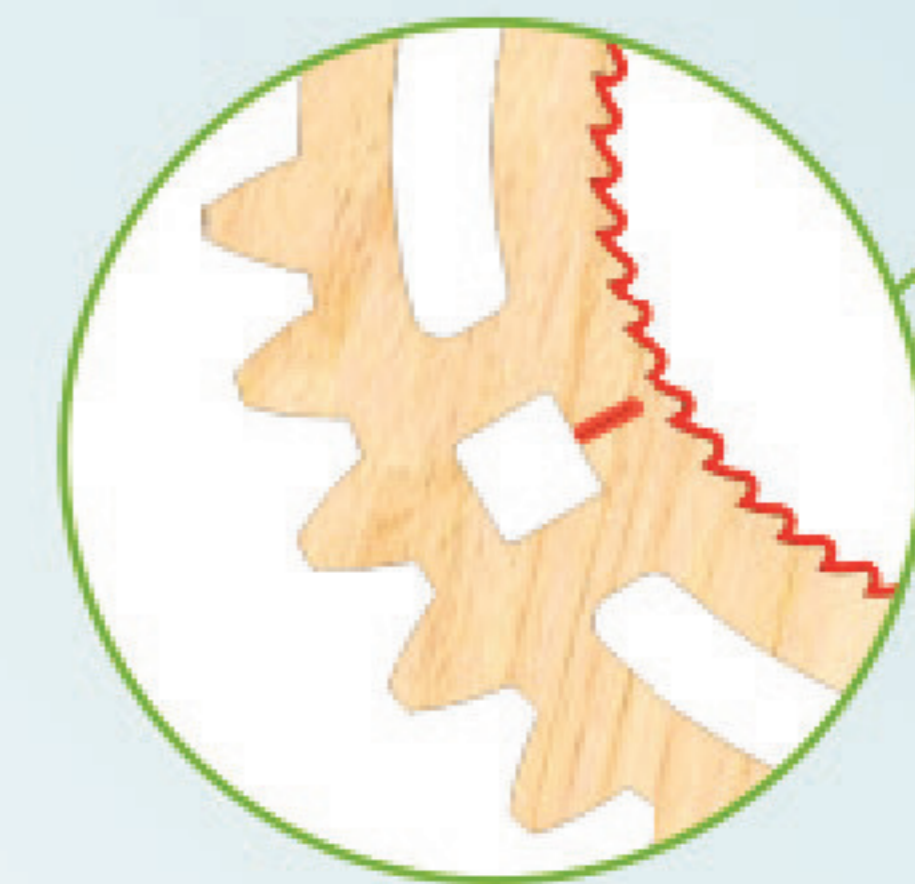

4

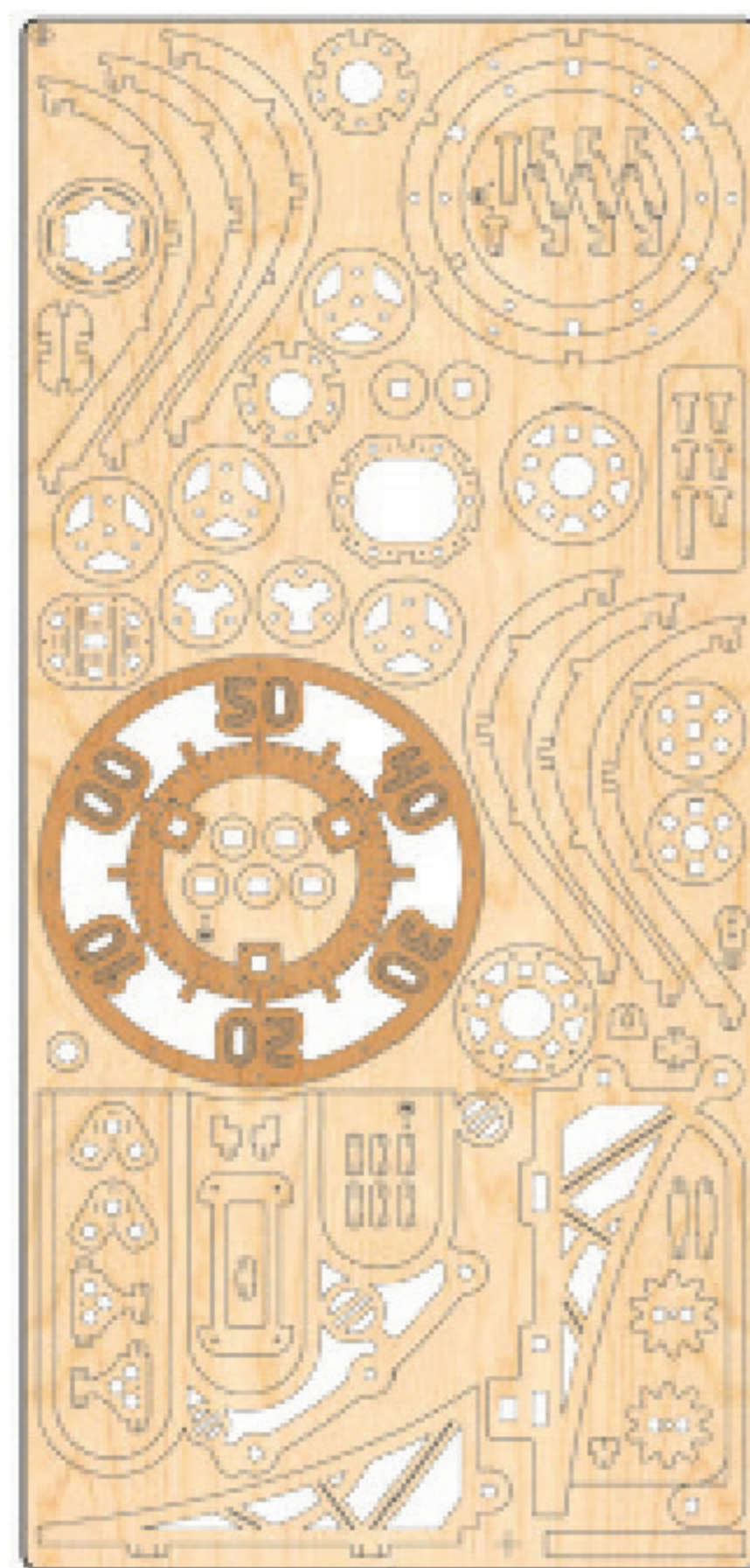

8

15

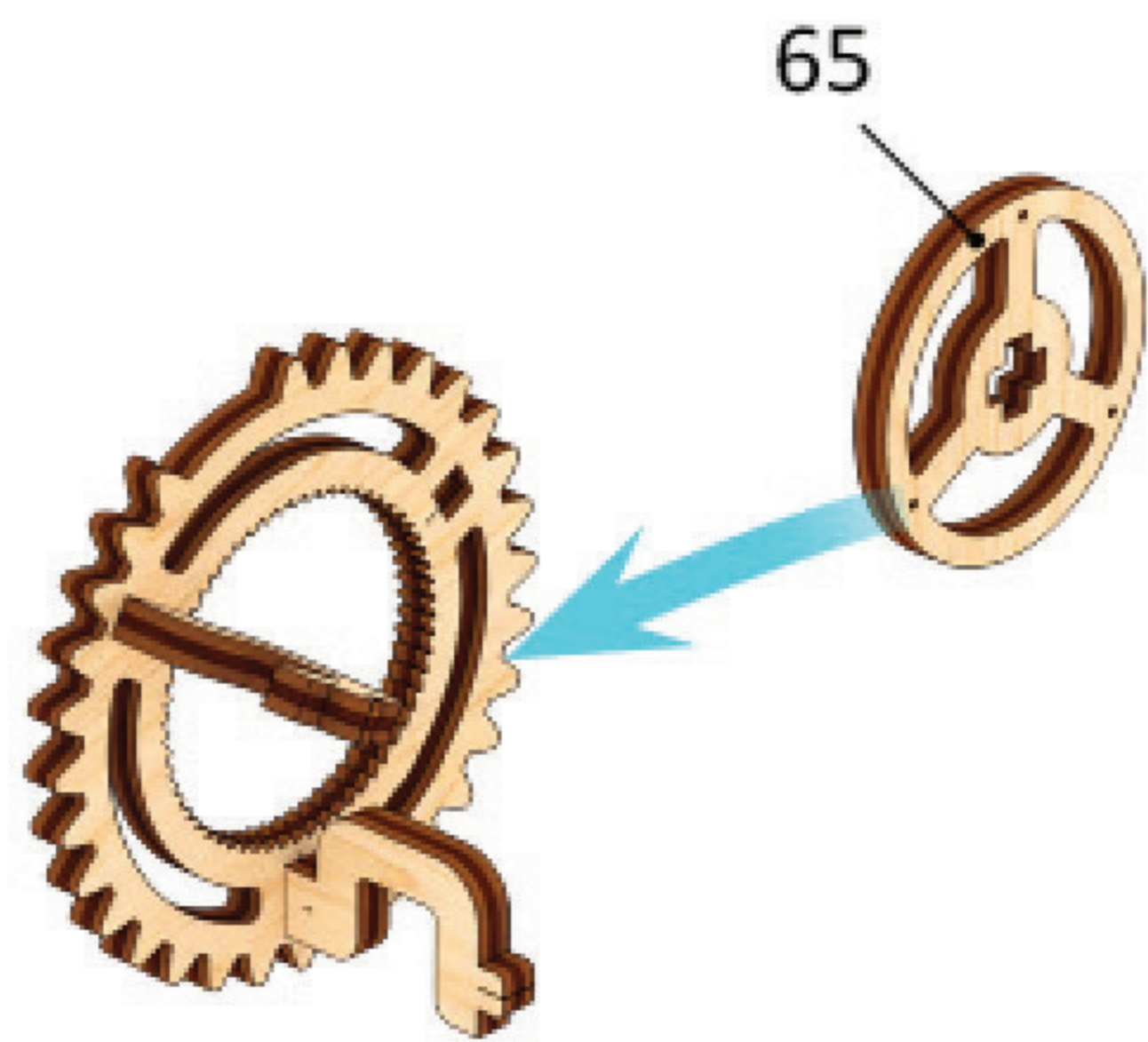

16

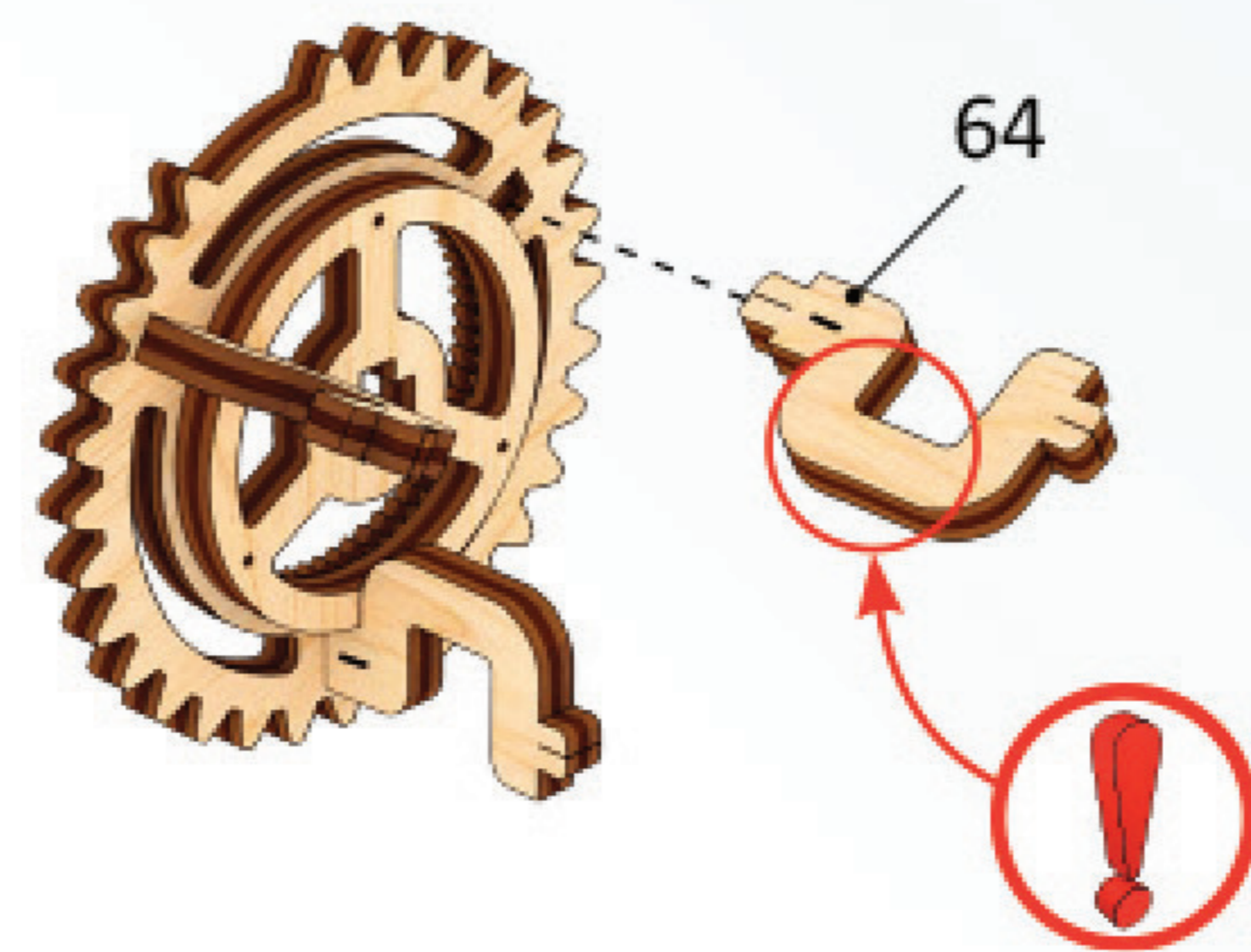

17

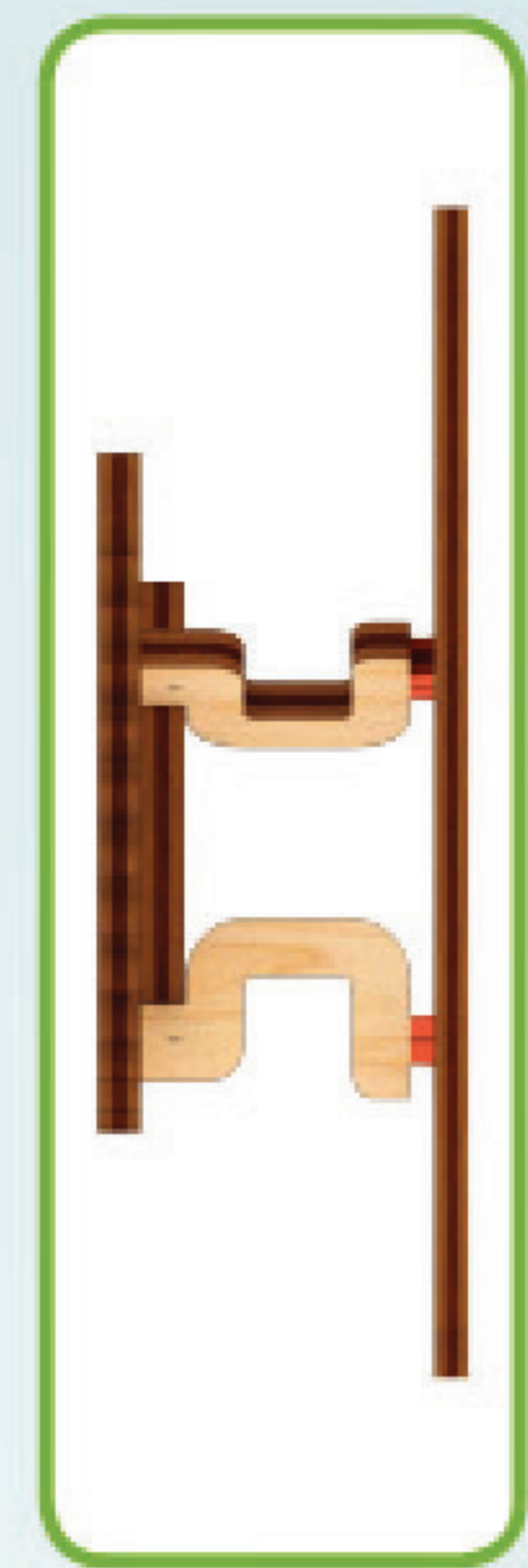
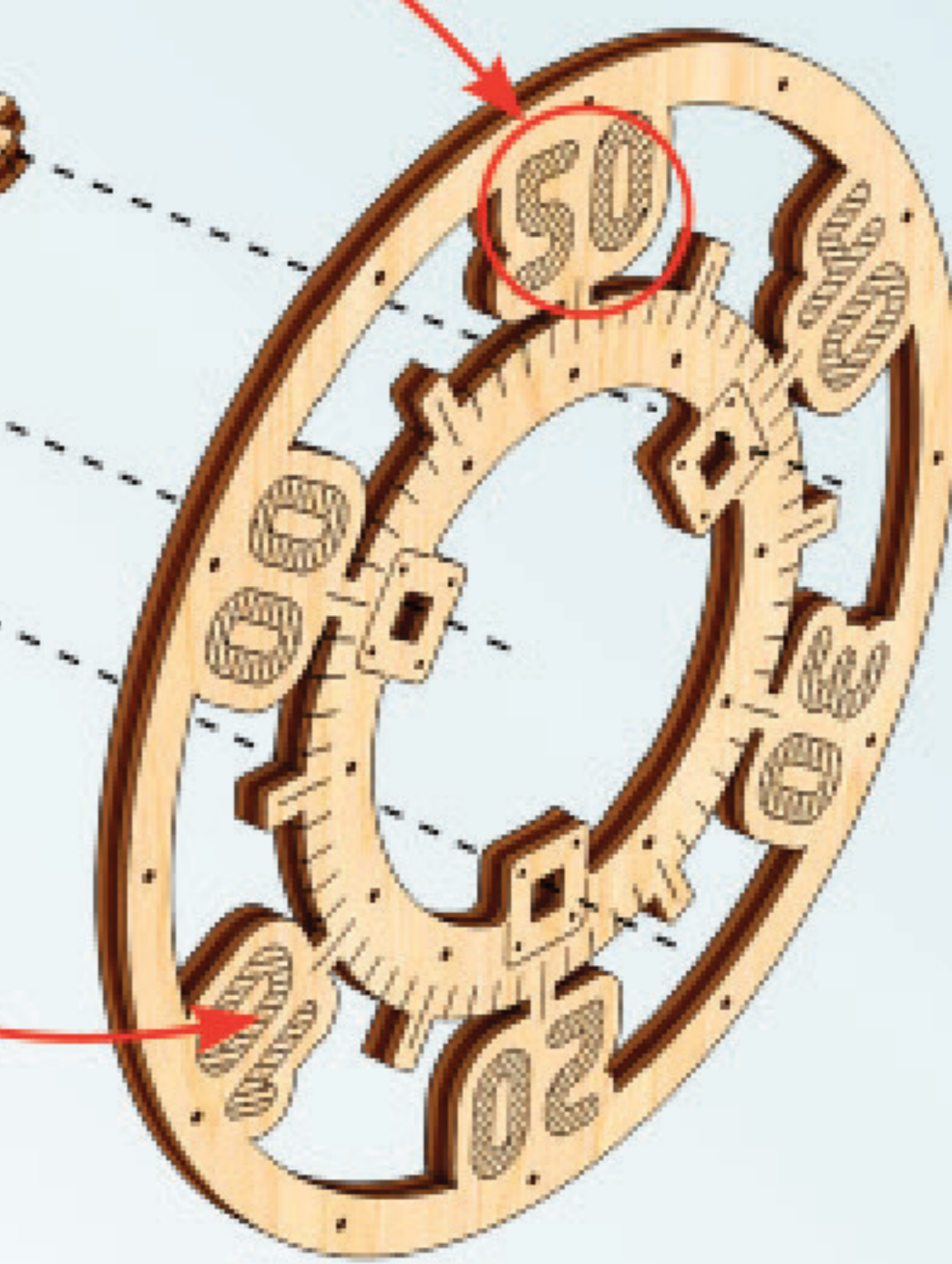
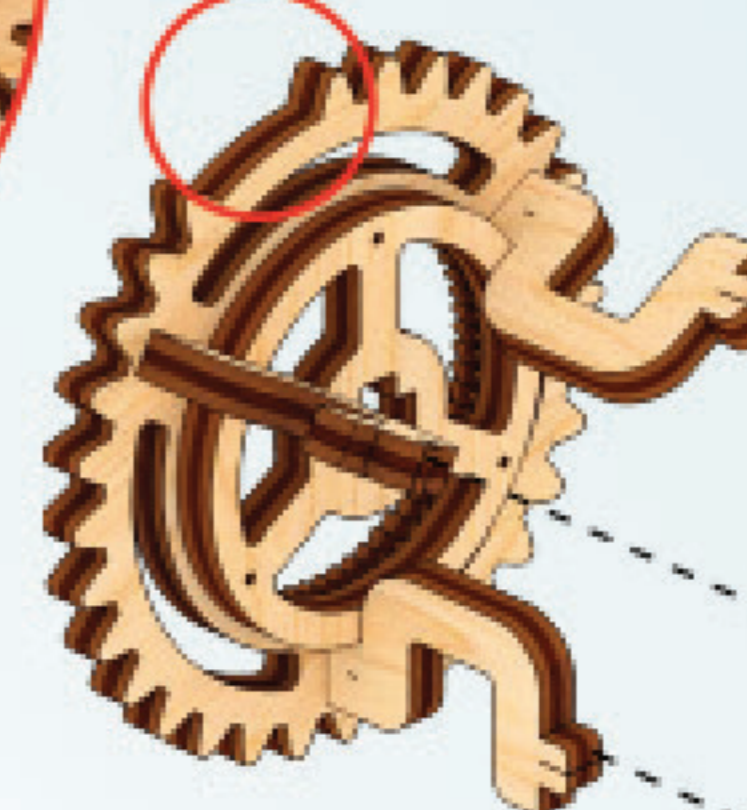
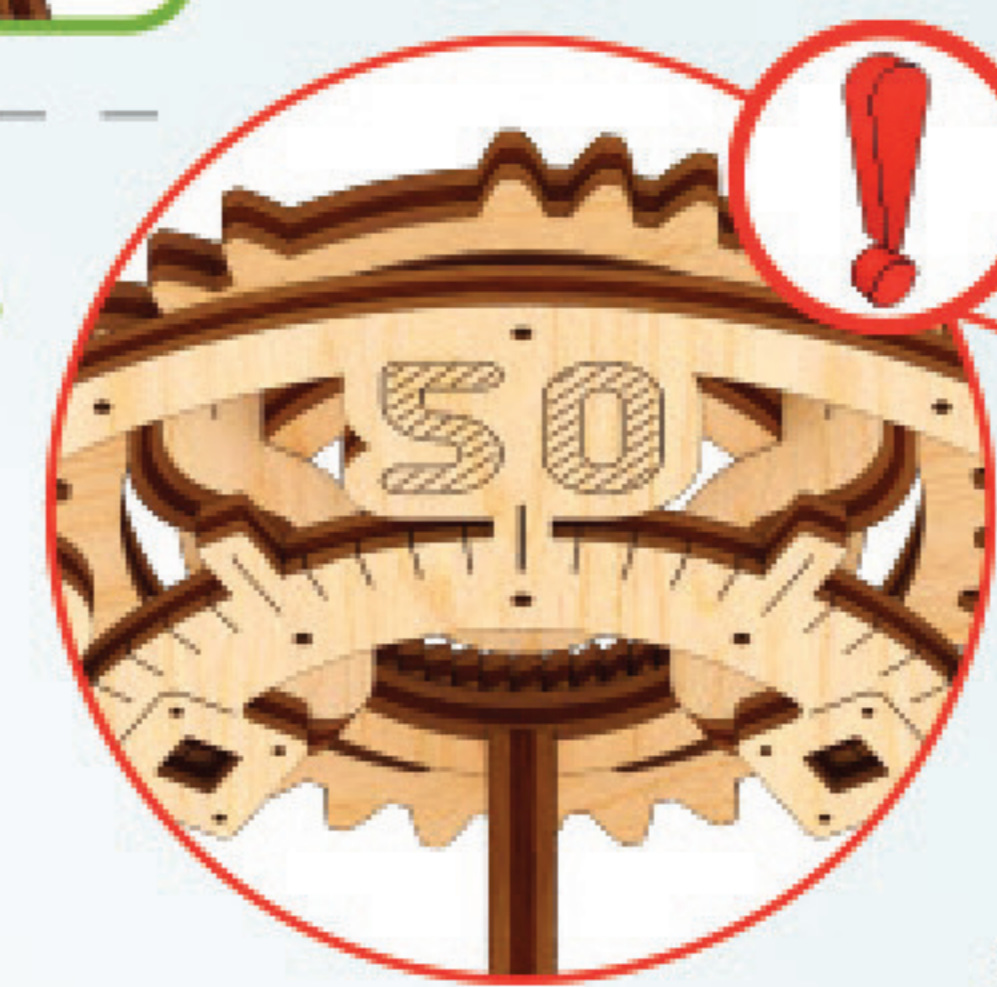

18

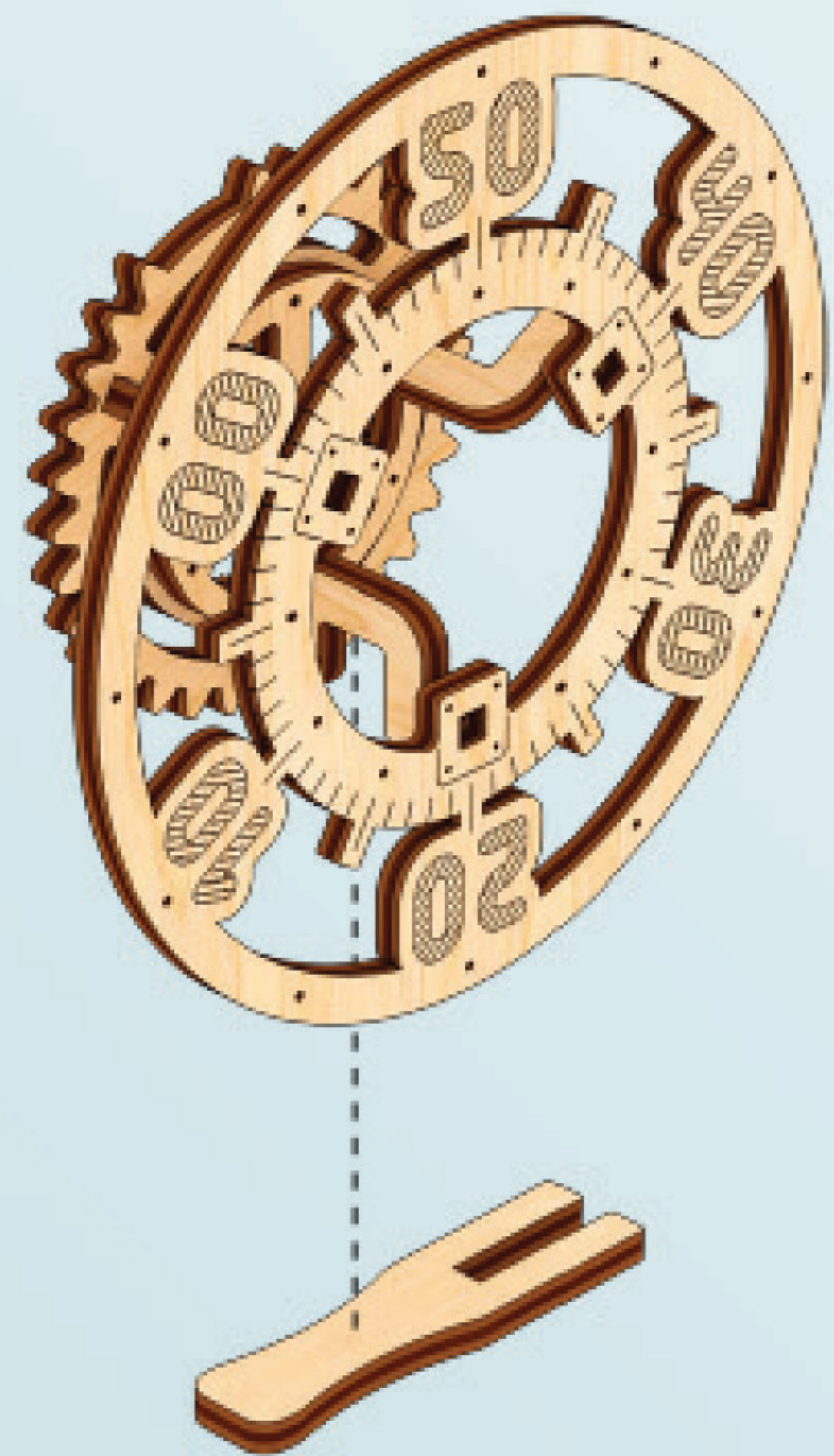

19

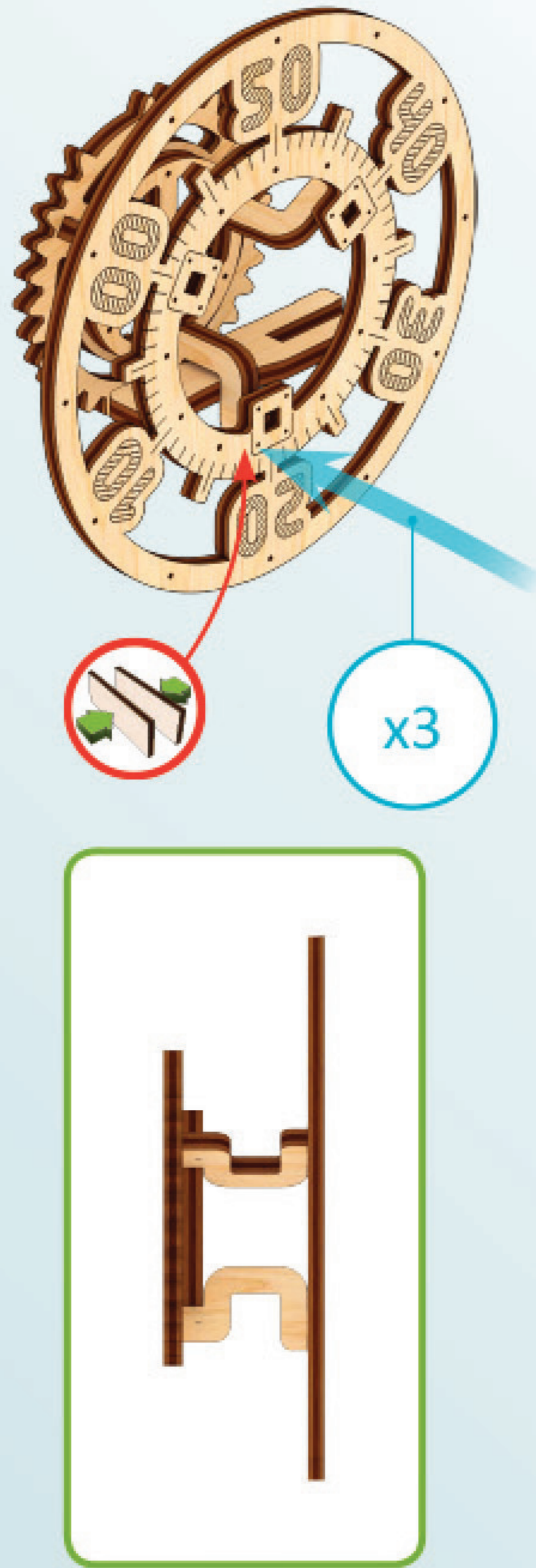

20

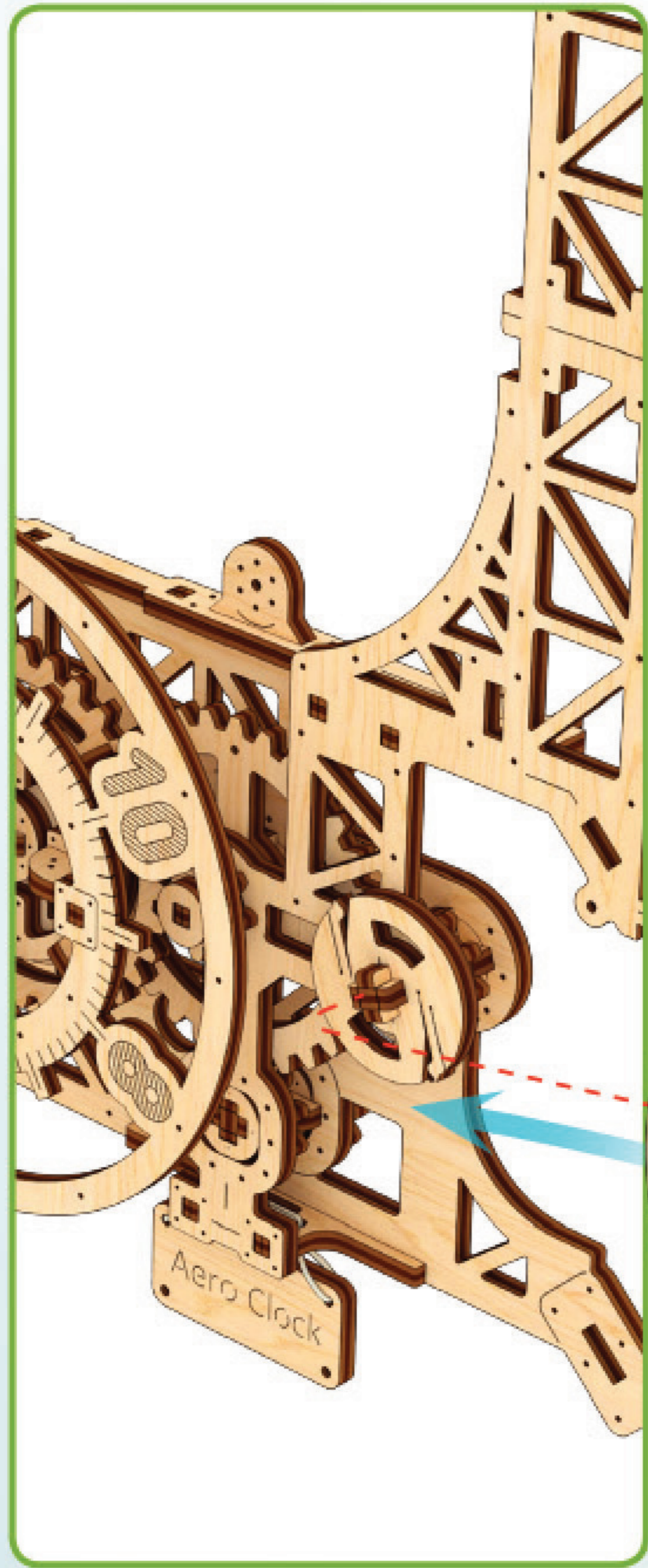

21

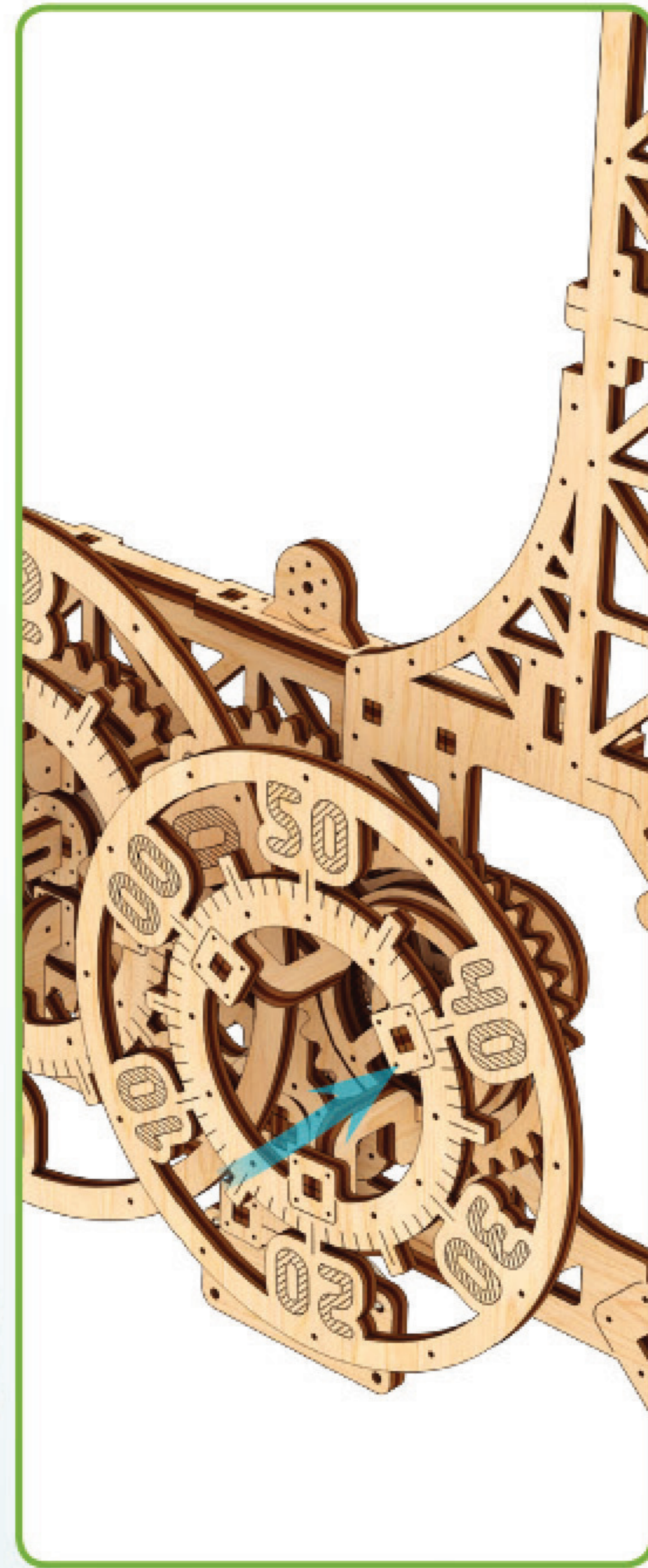

C

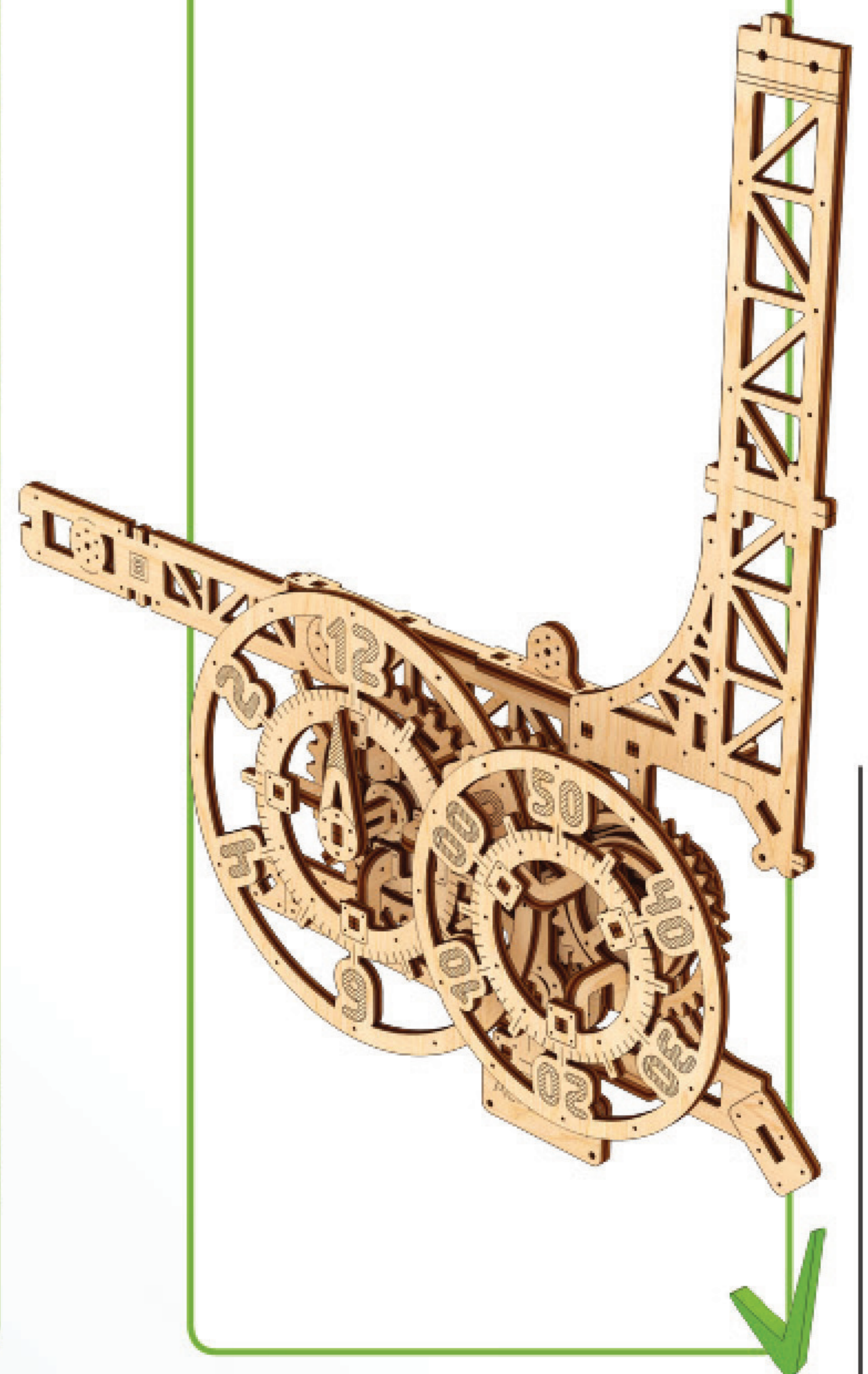

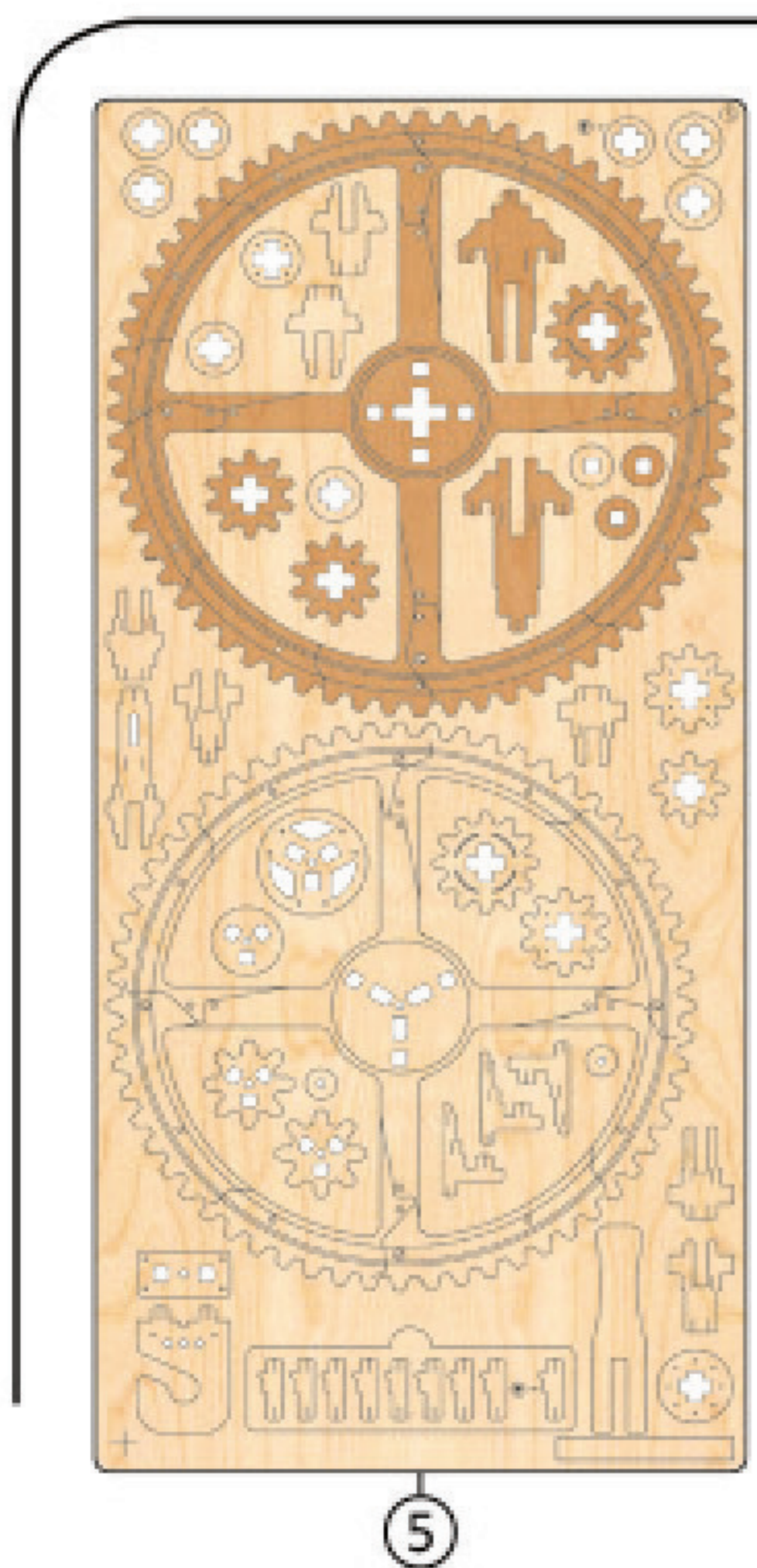

1

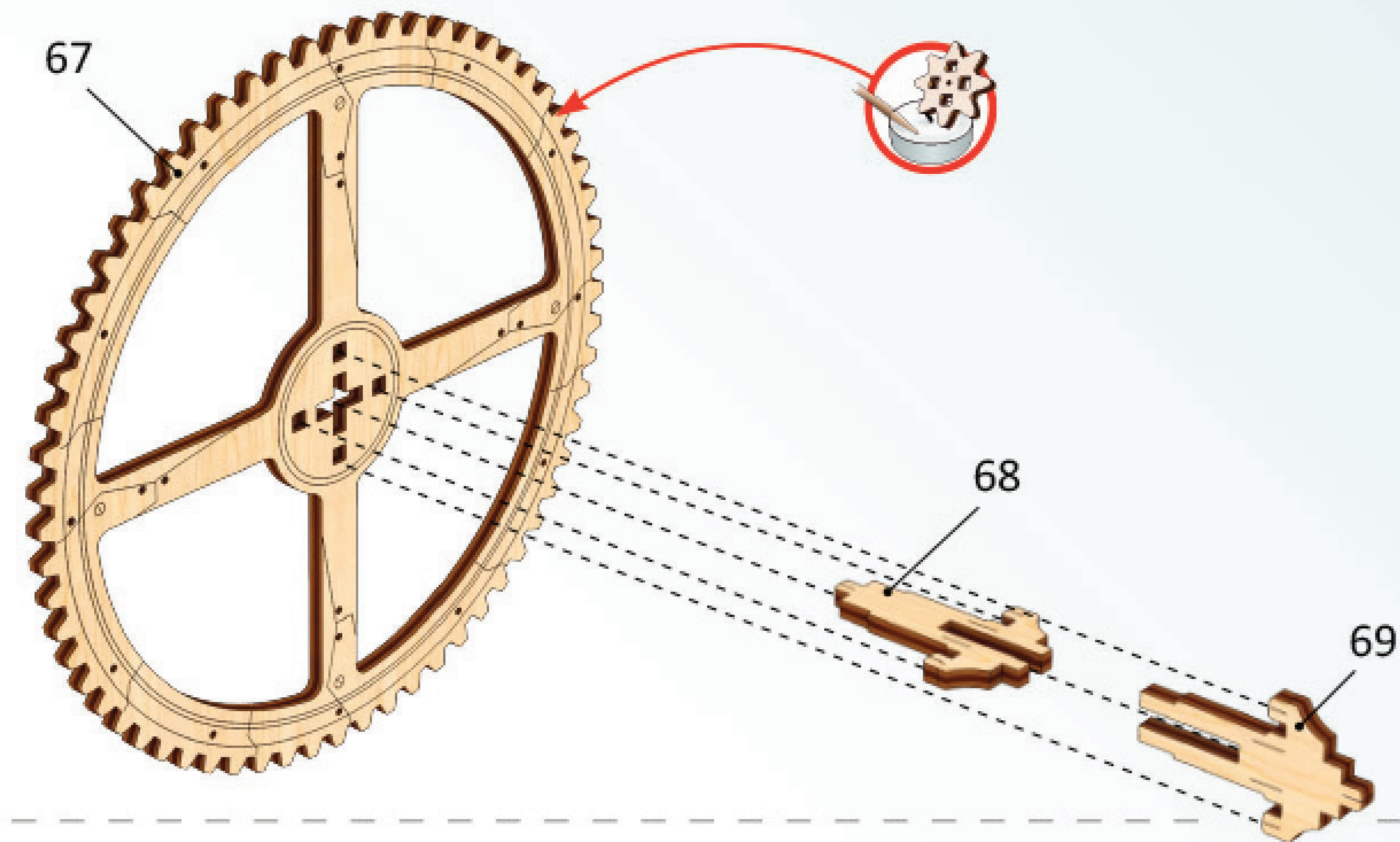

2

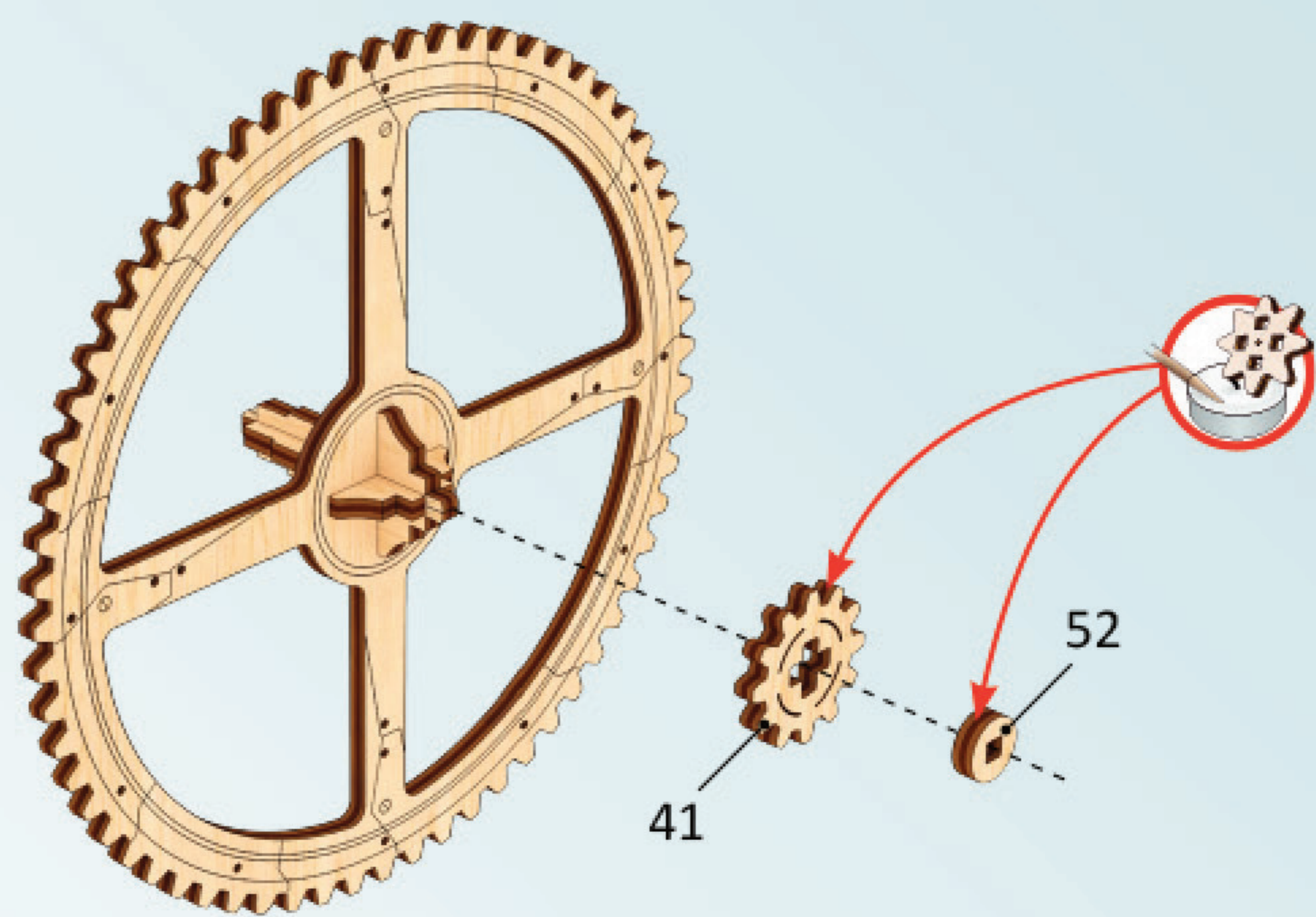

3

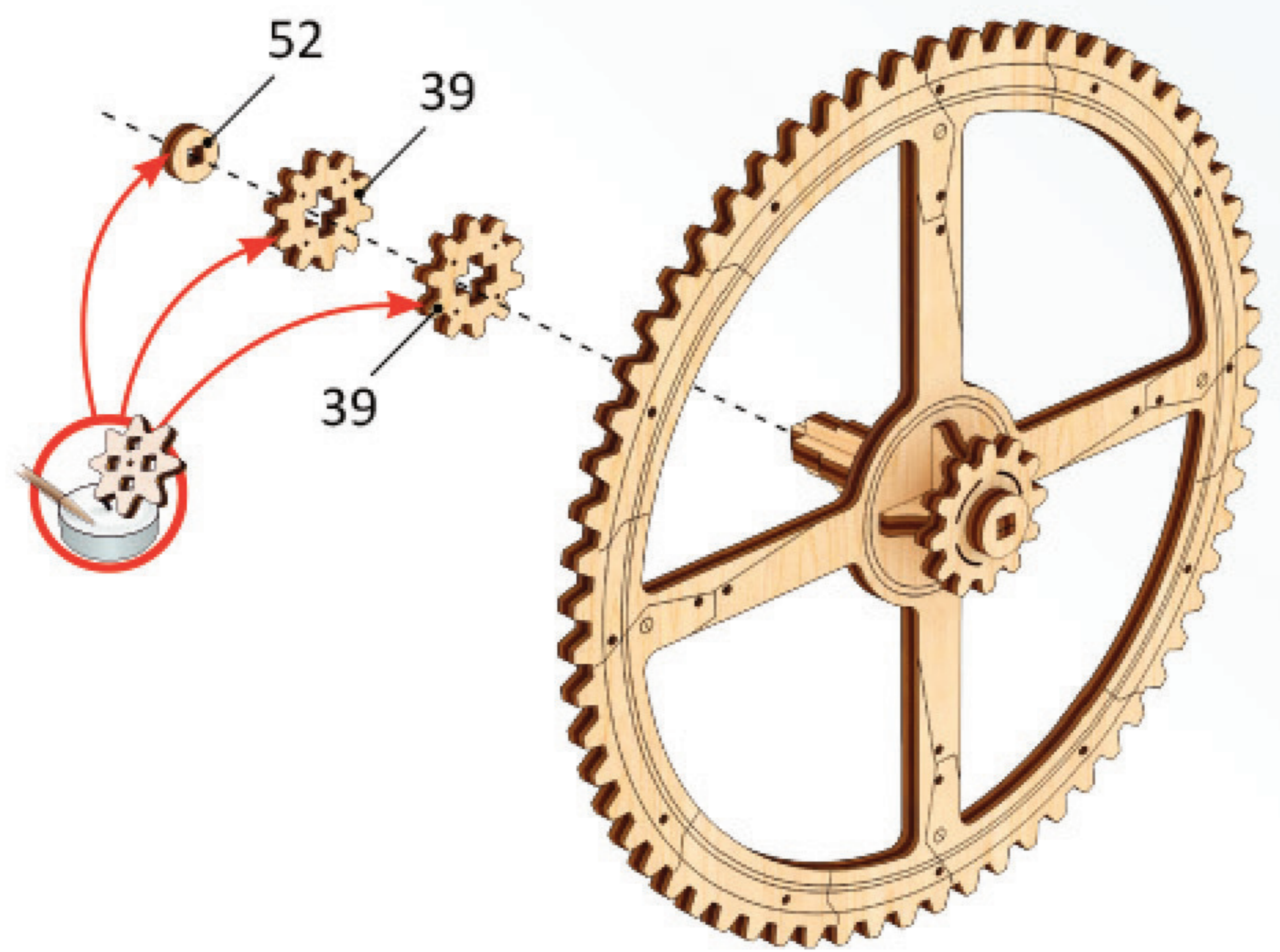
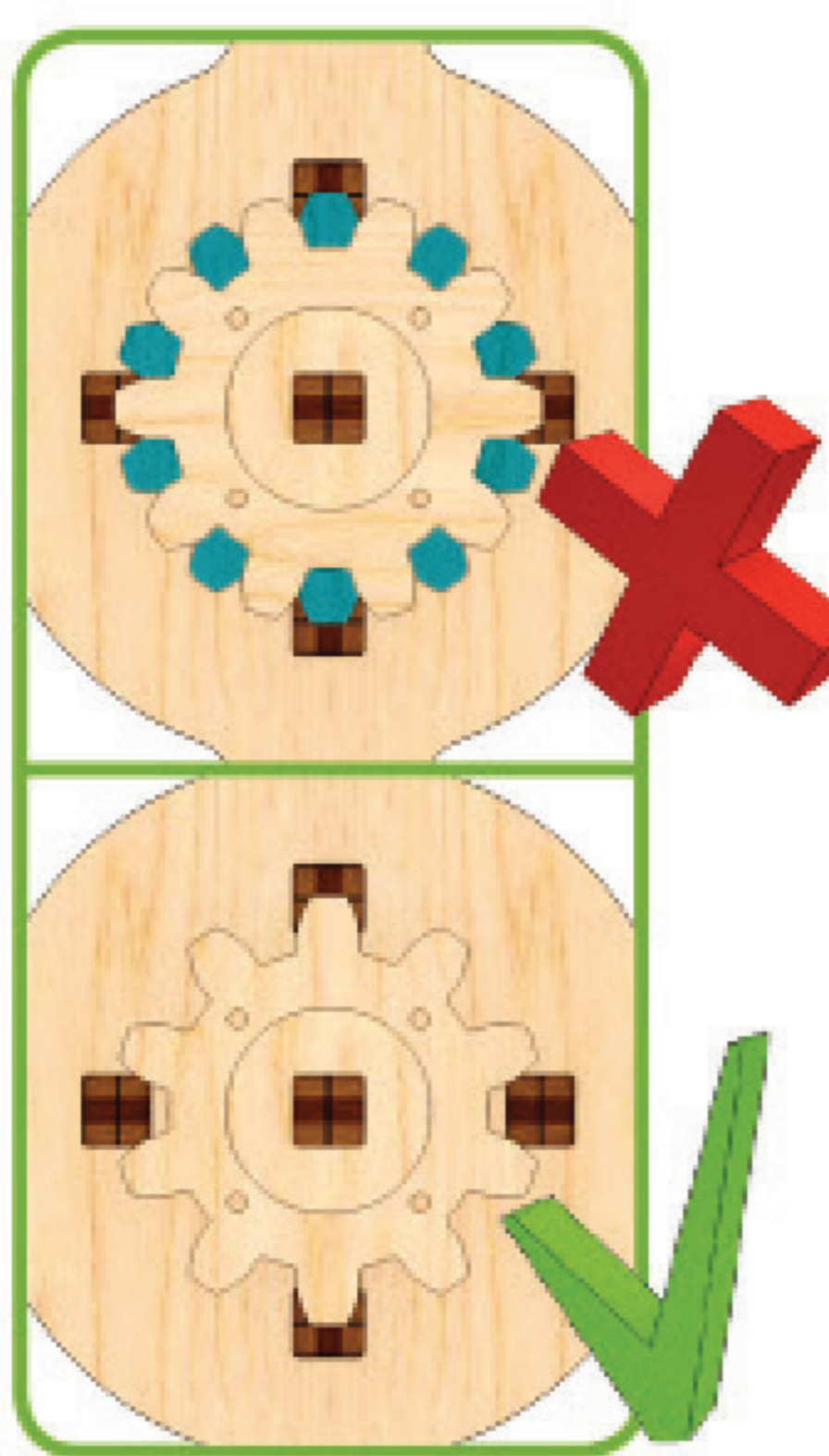

d1

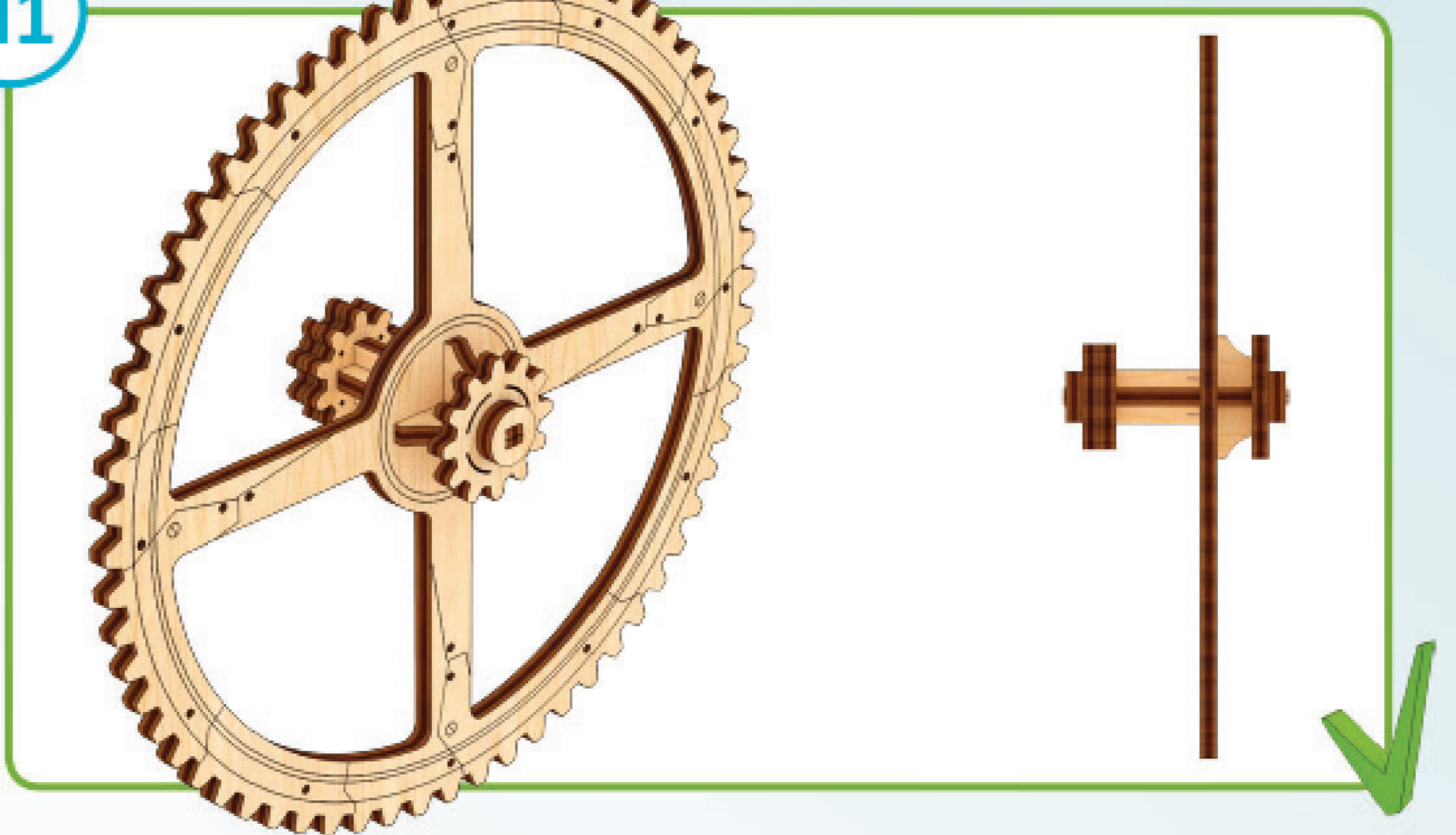

Mechanical models



5

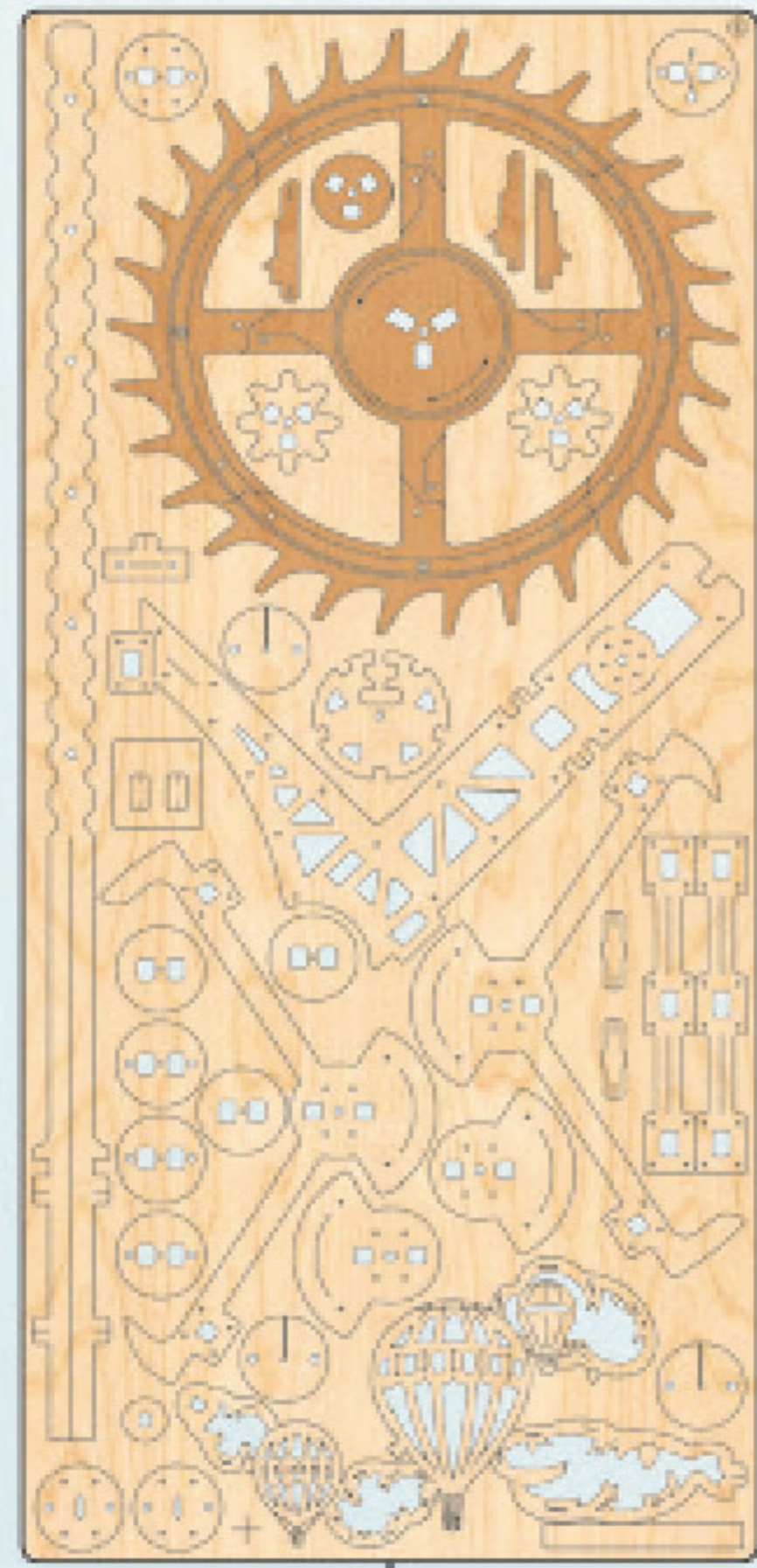

6

1

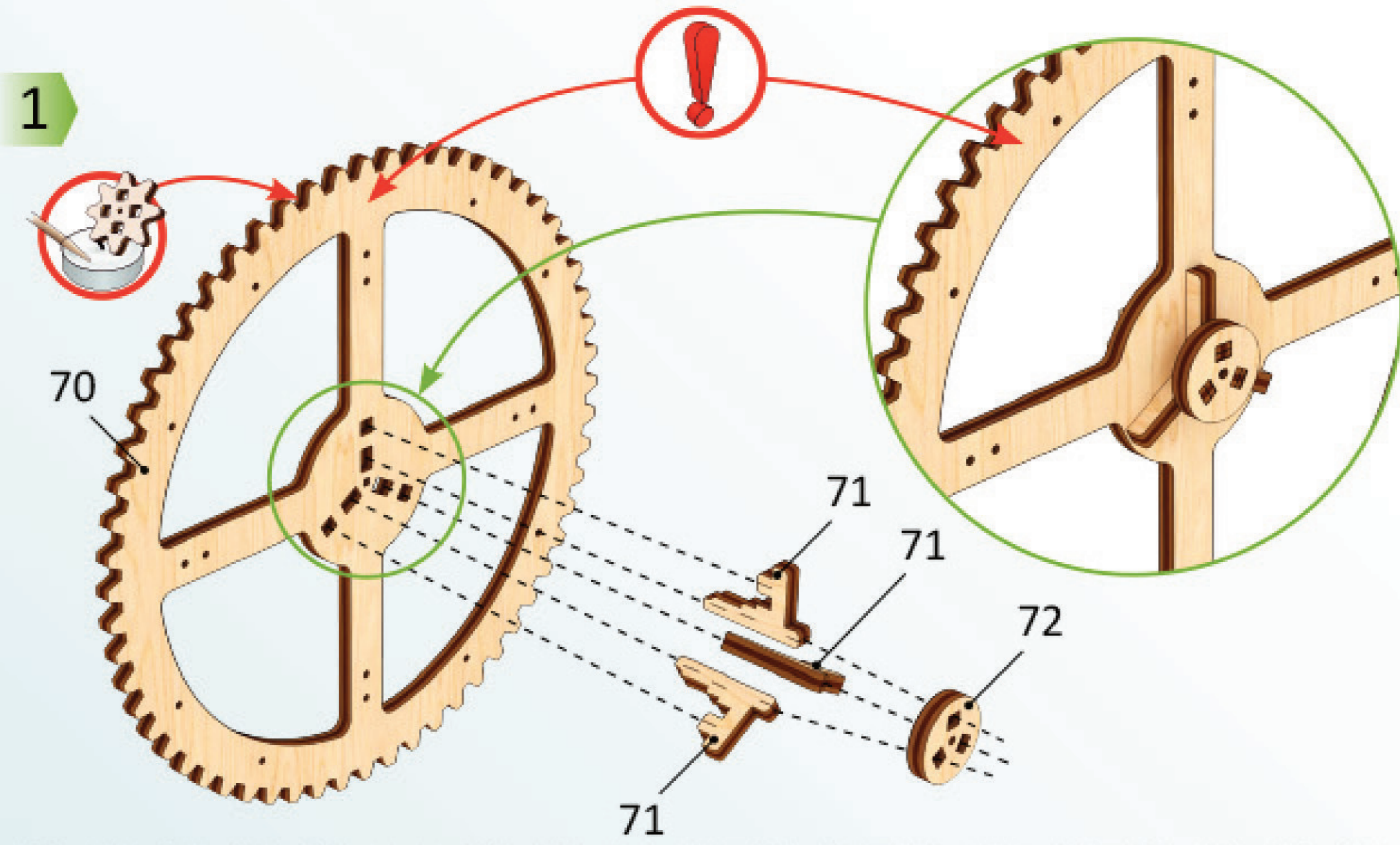

2

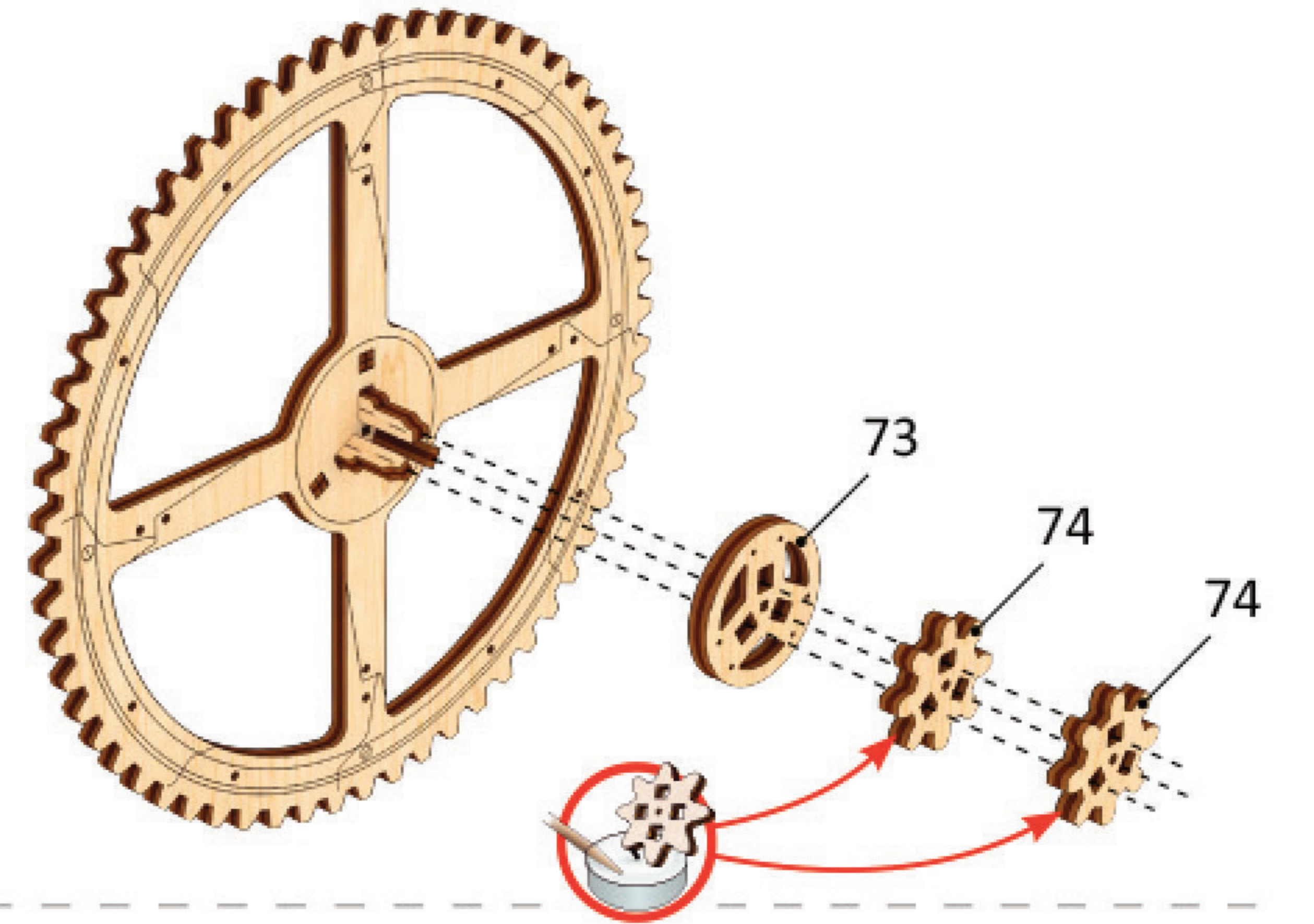
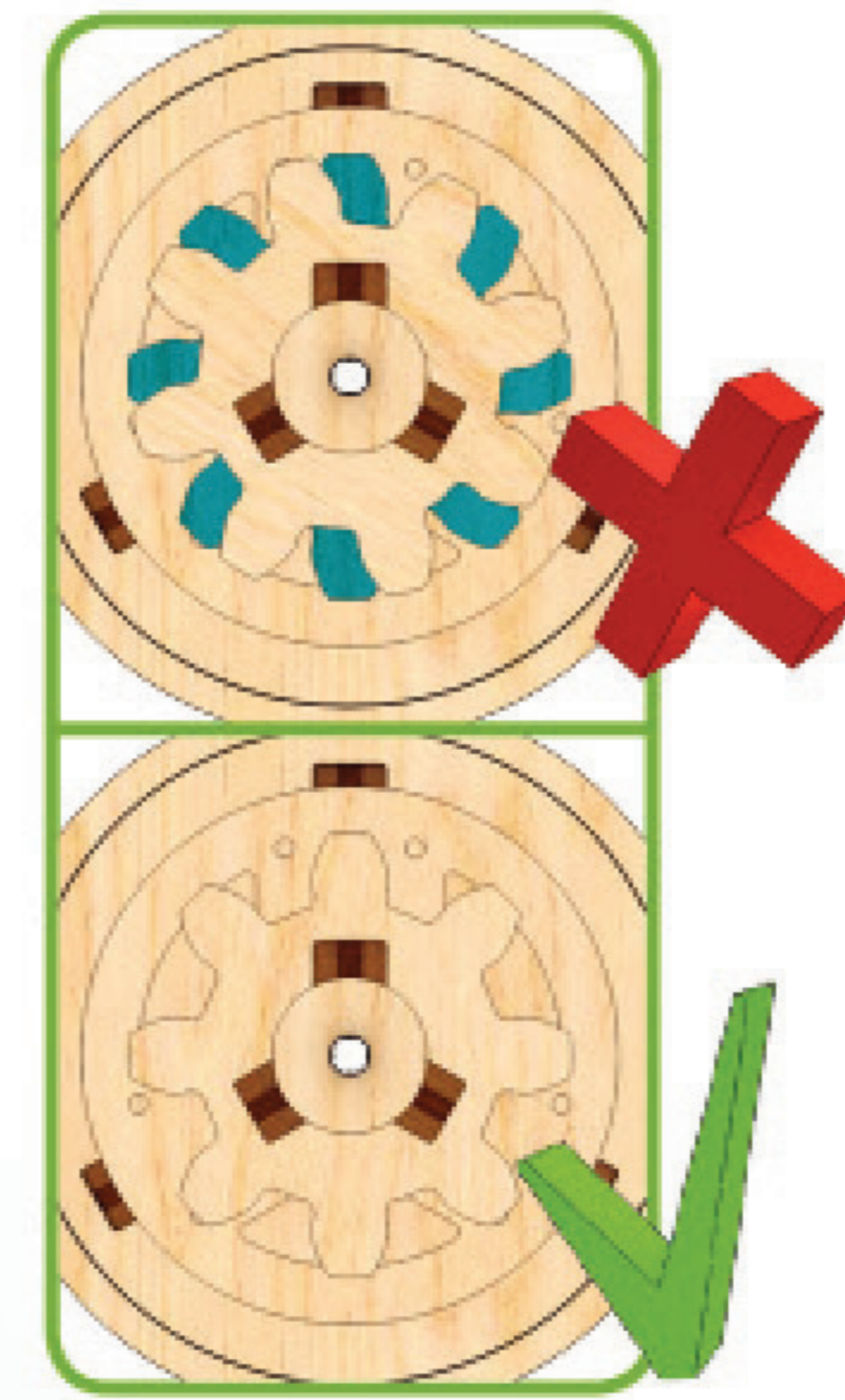

3

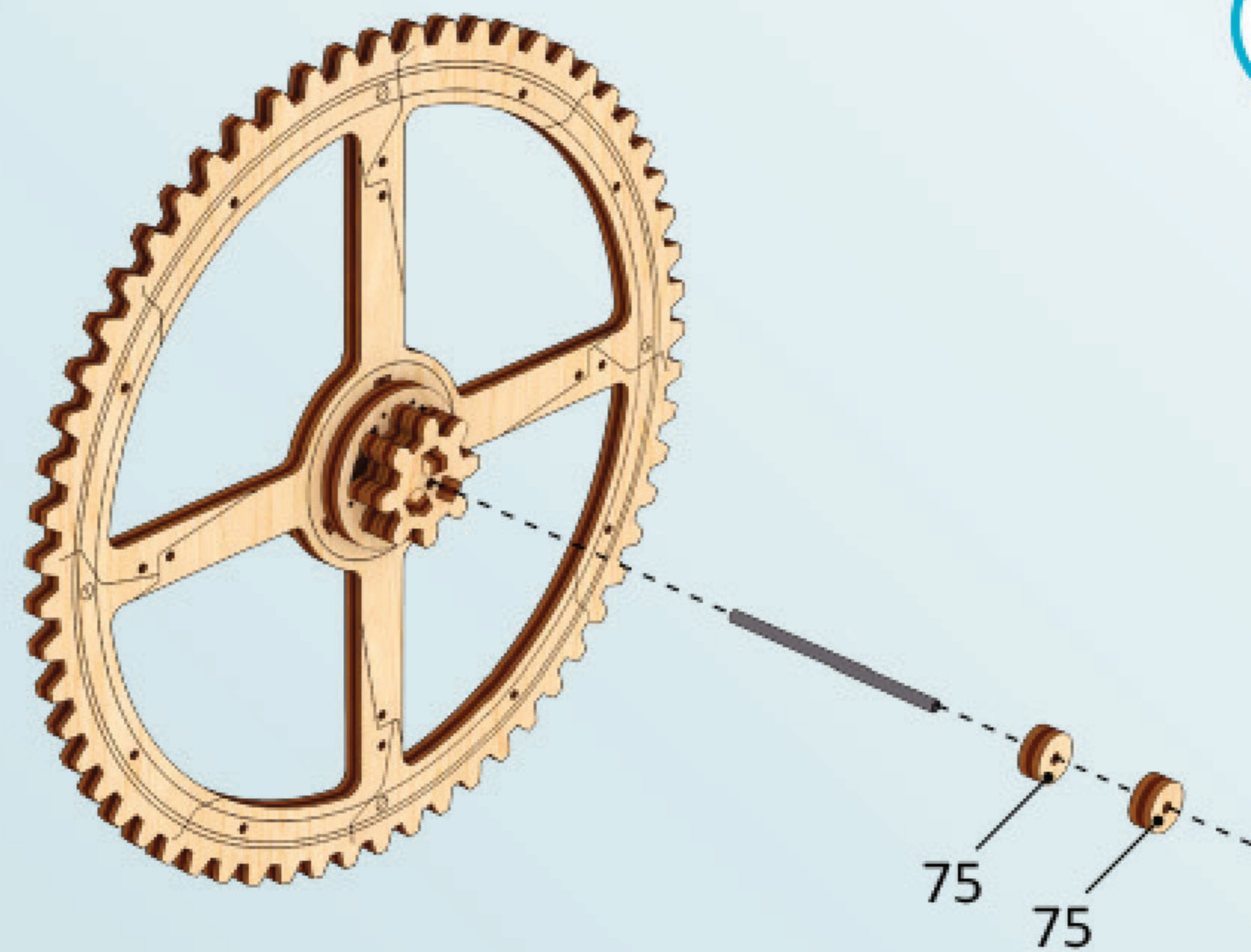
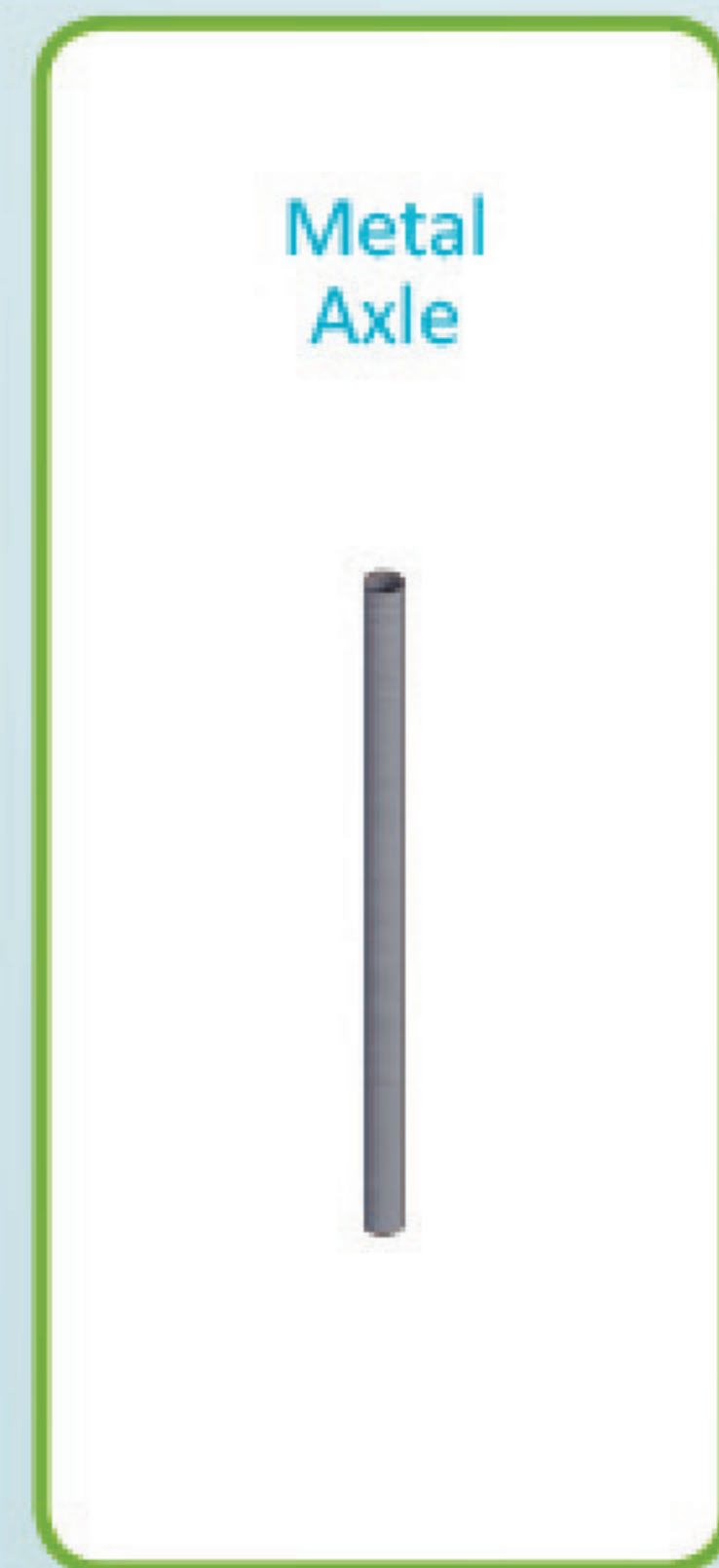

d2

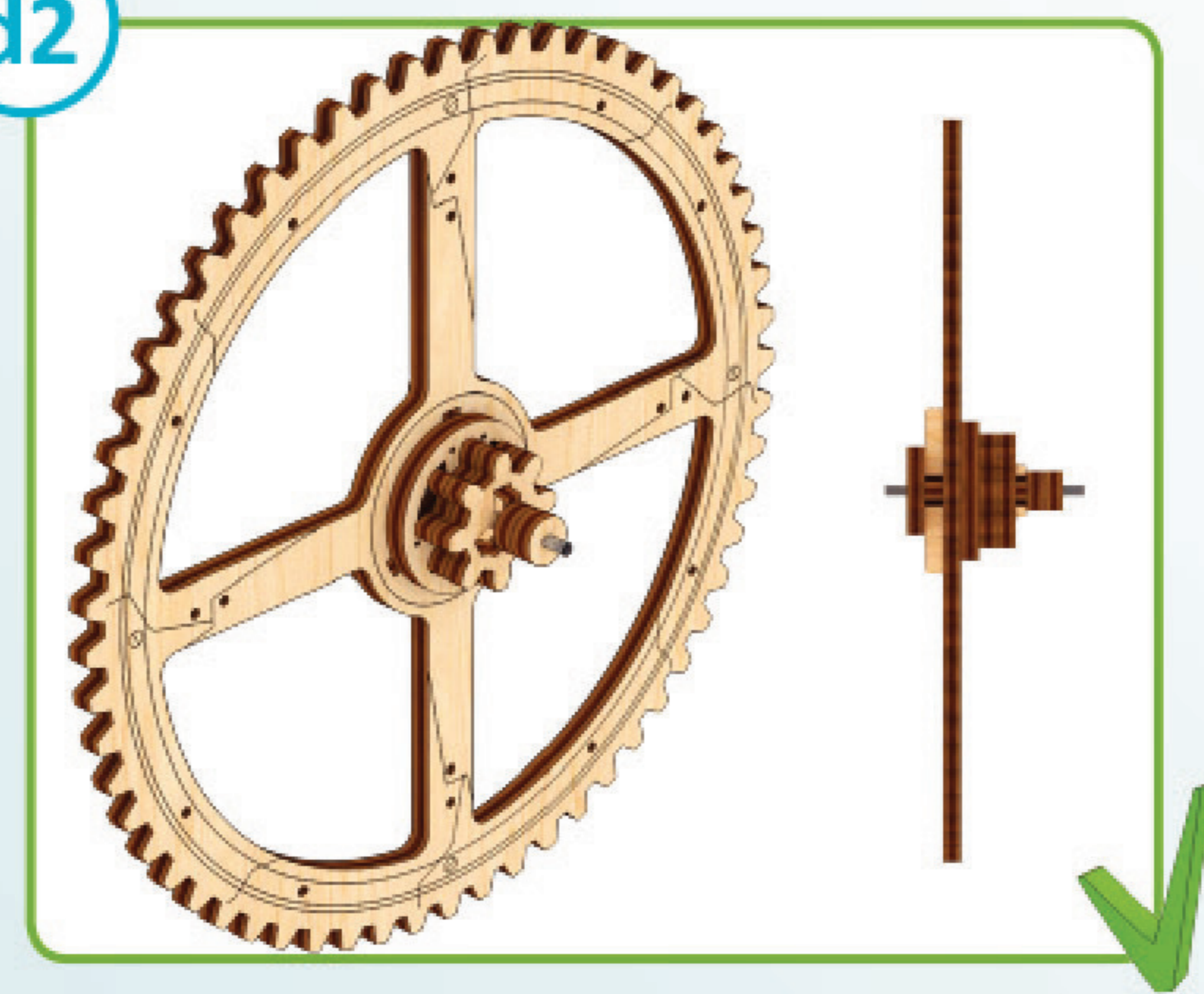

1

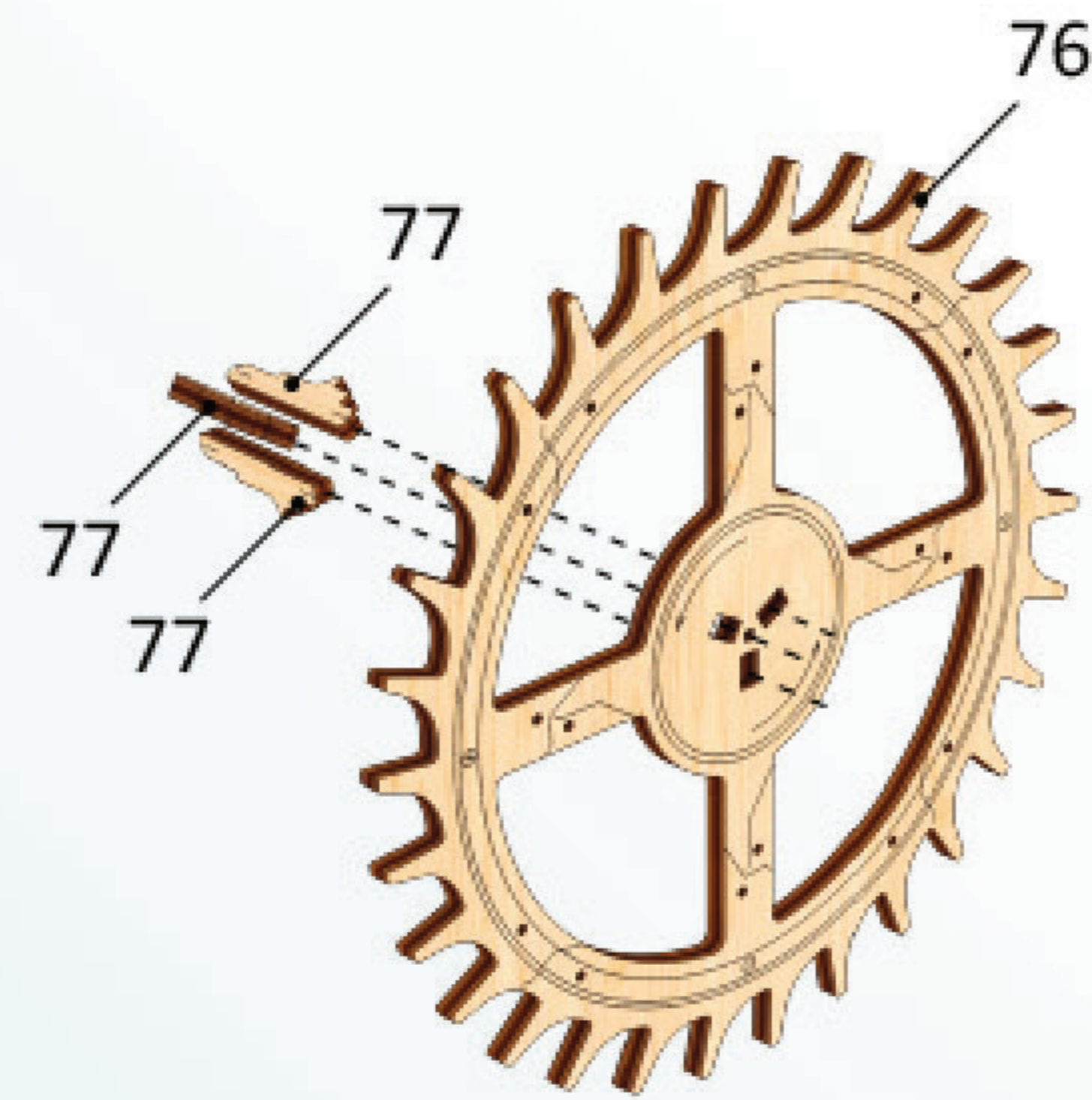

2

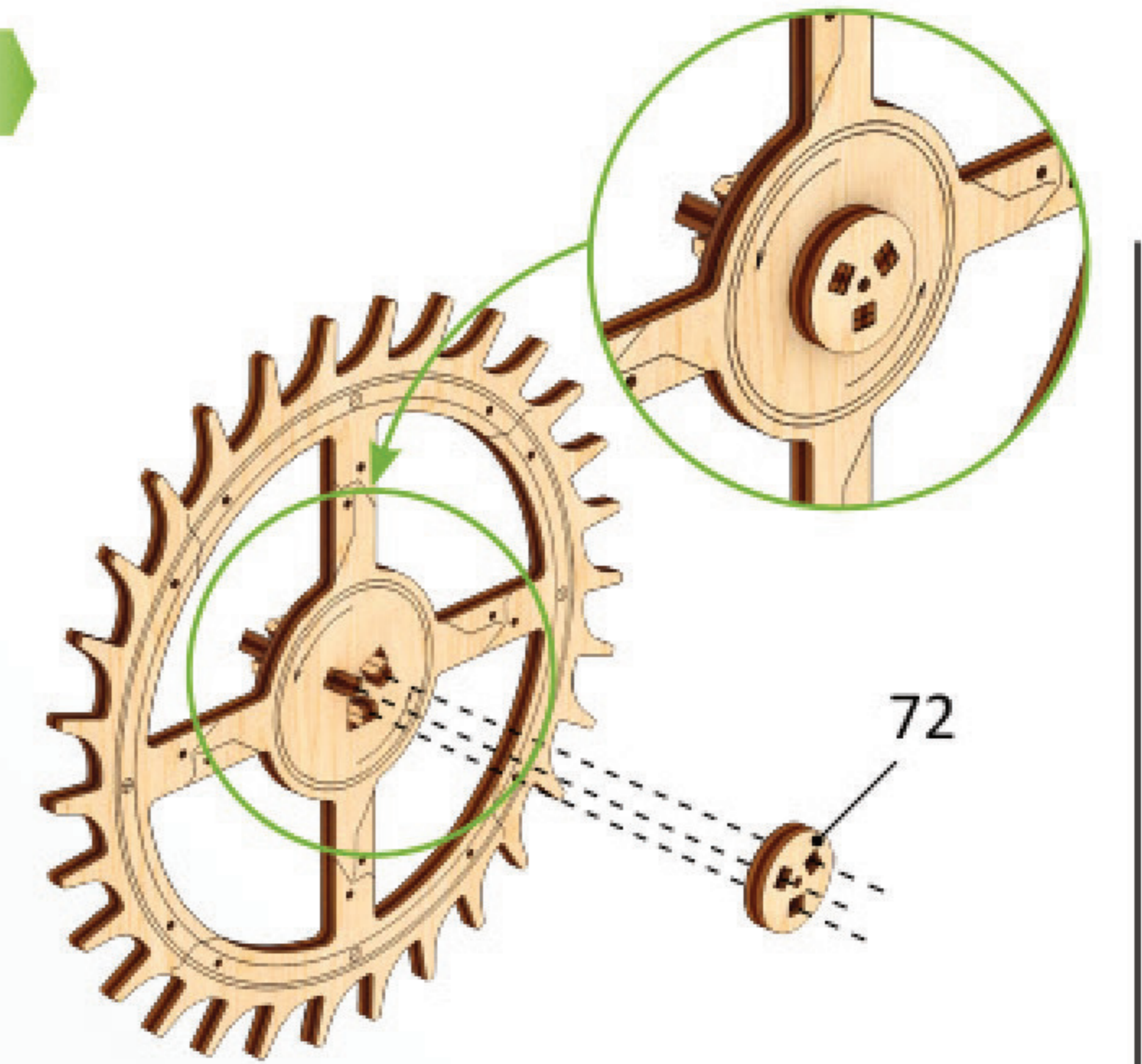



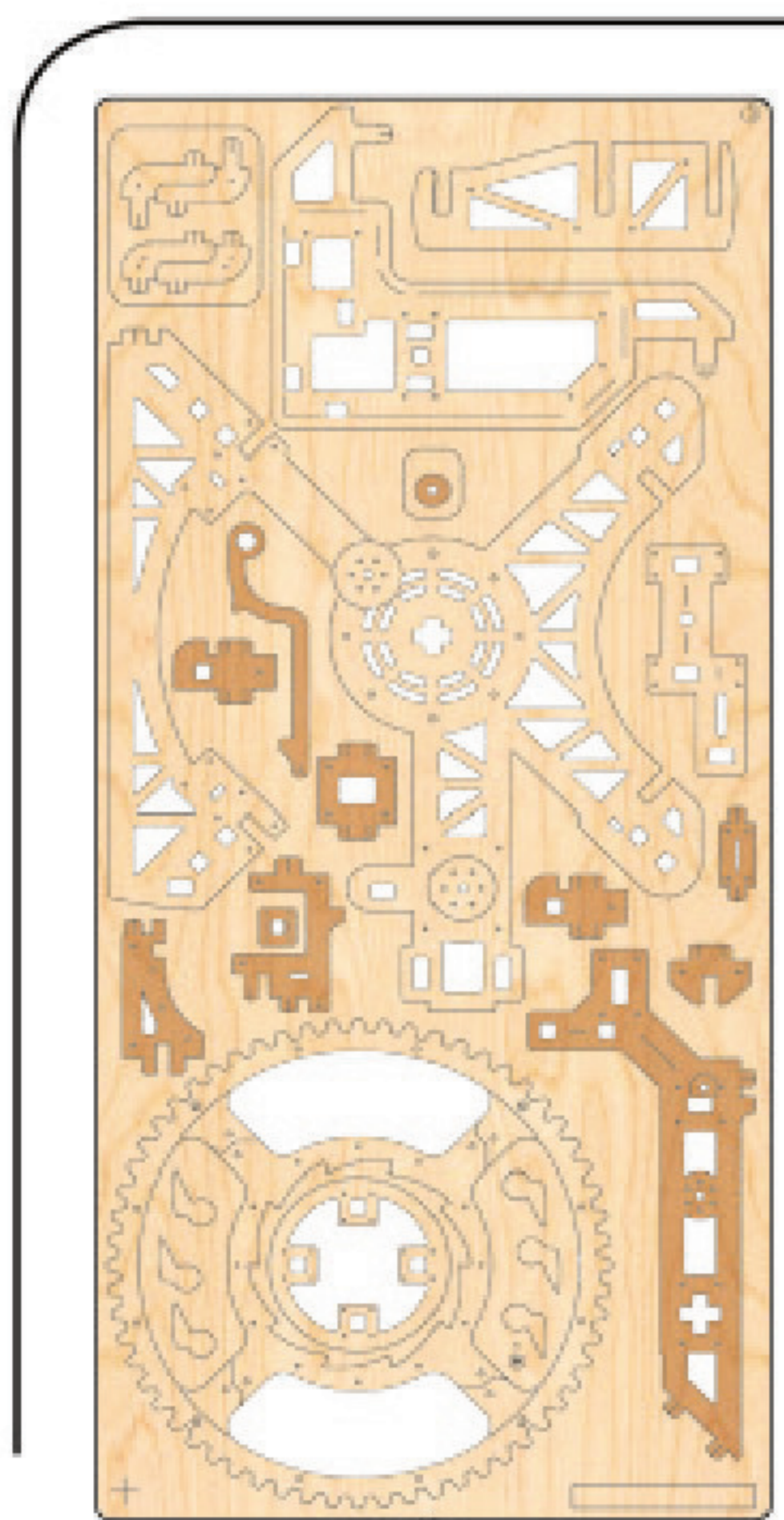

3

3

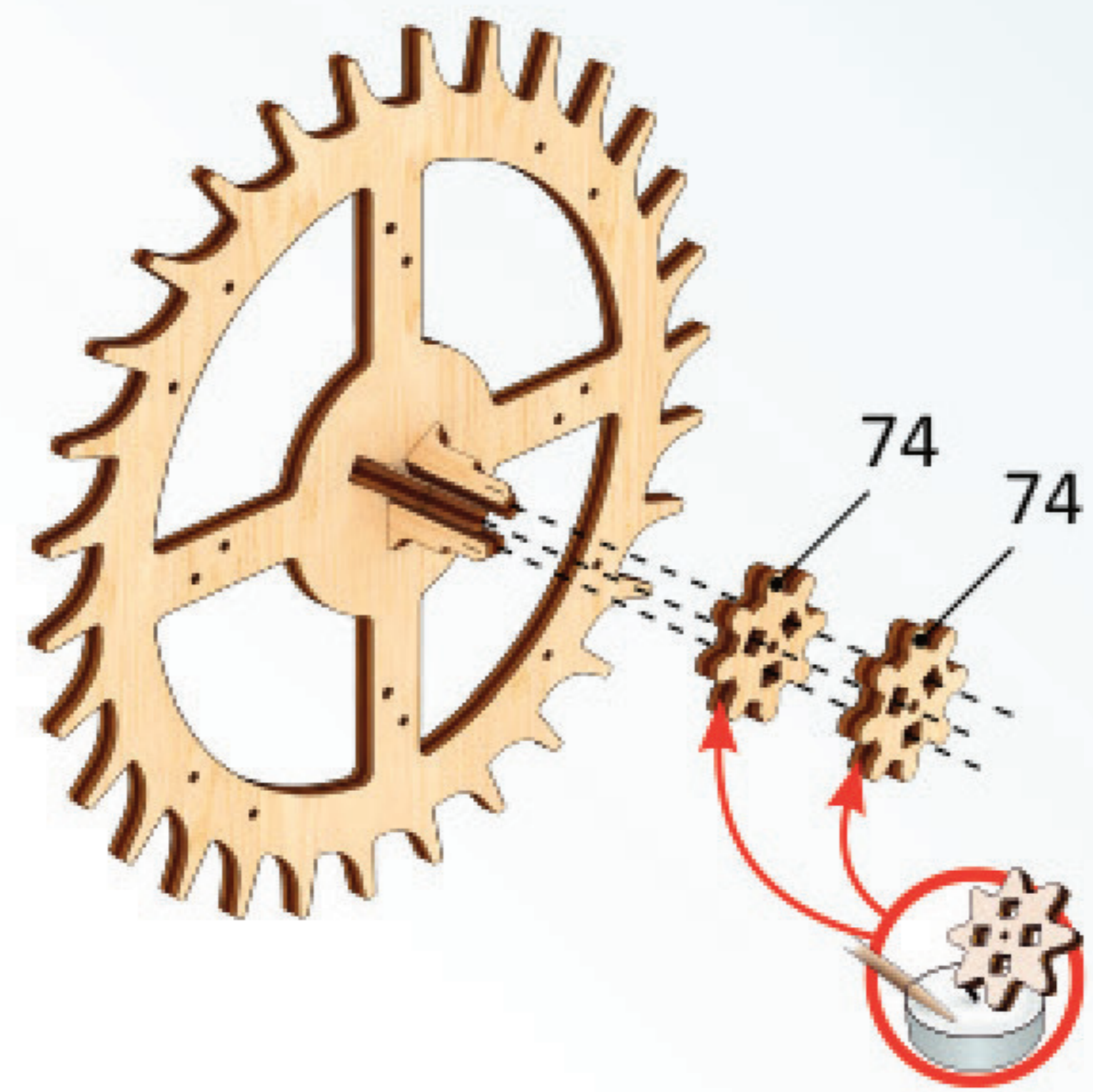
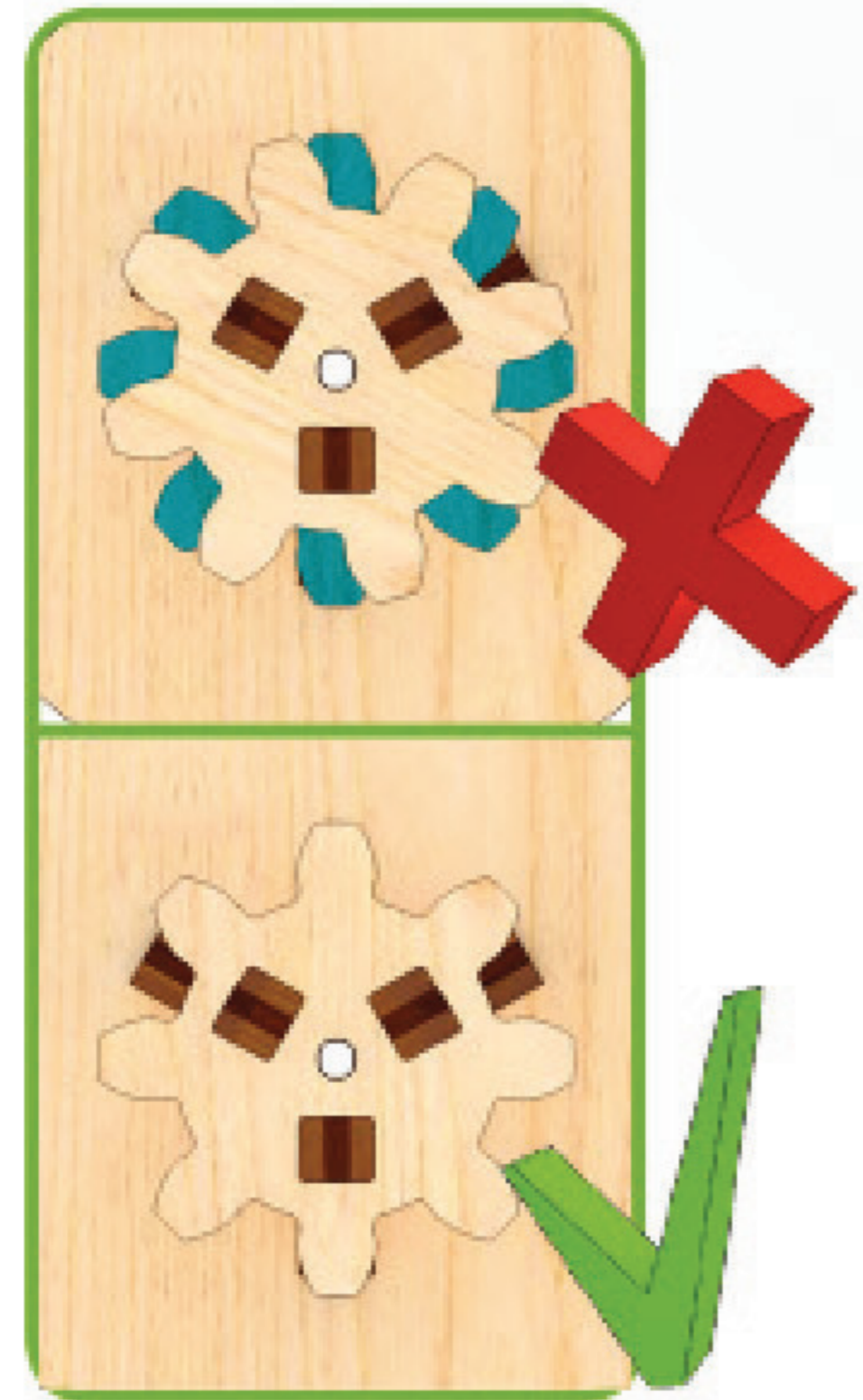

4

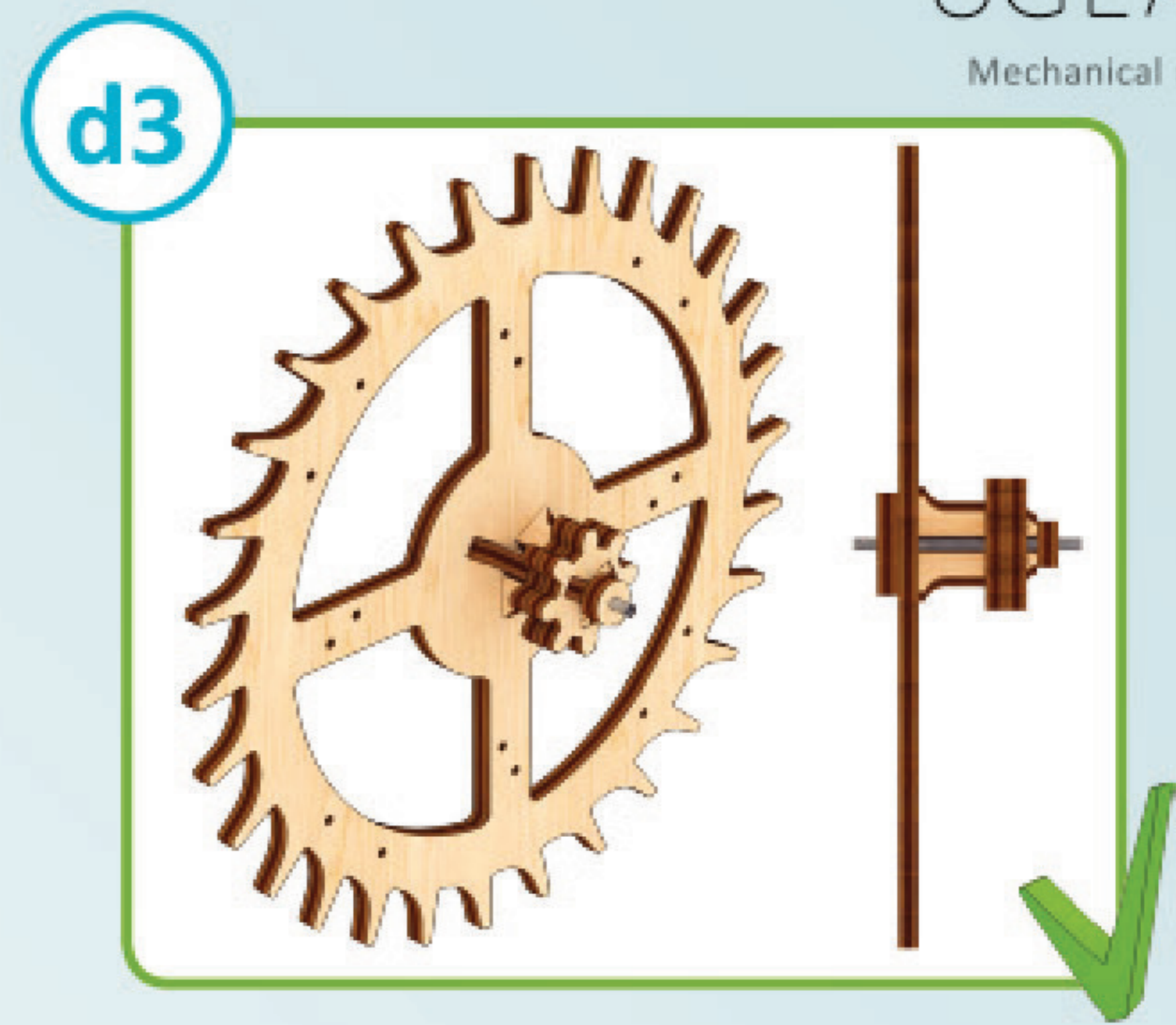
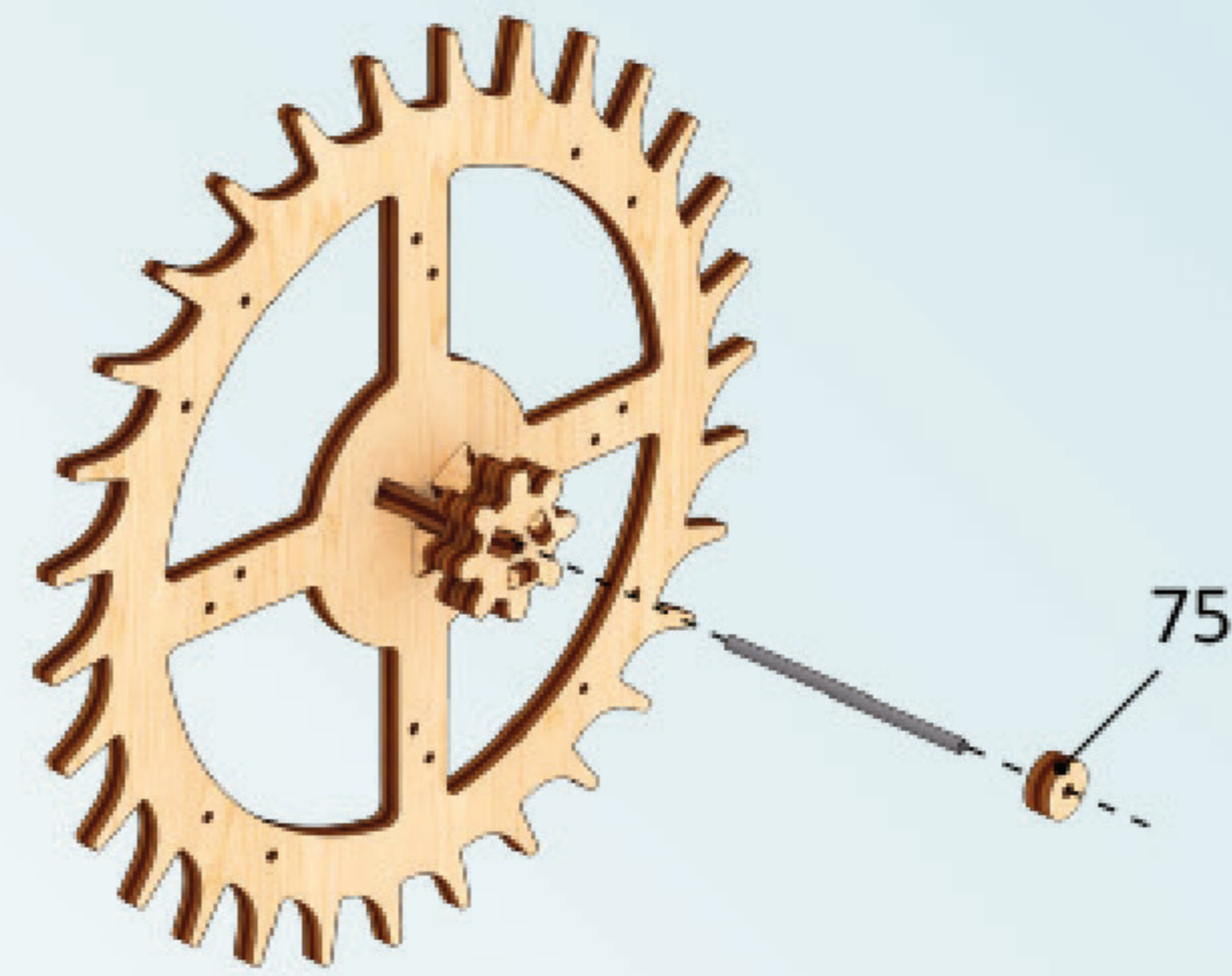

d3

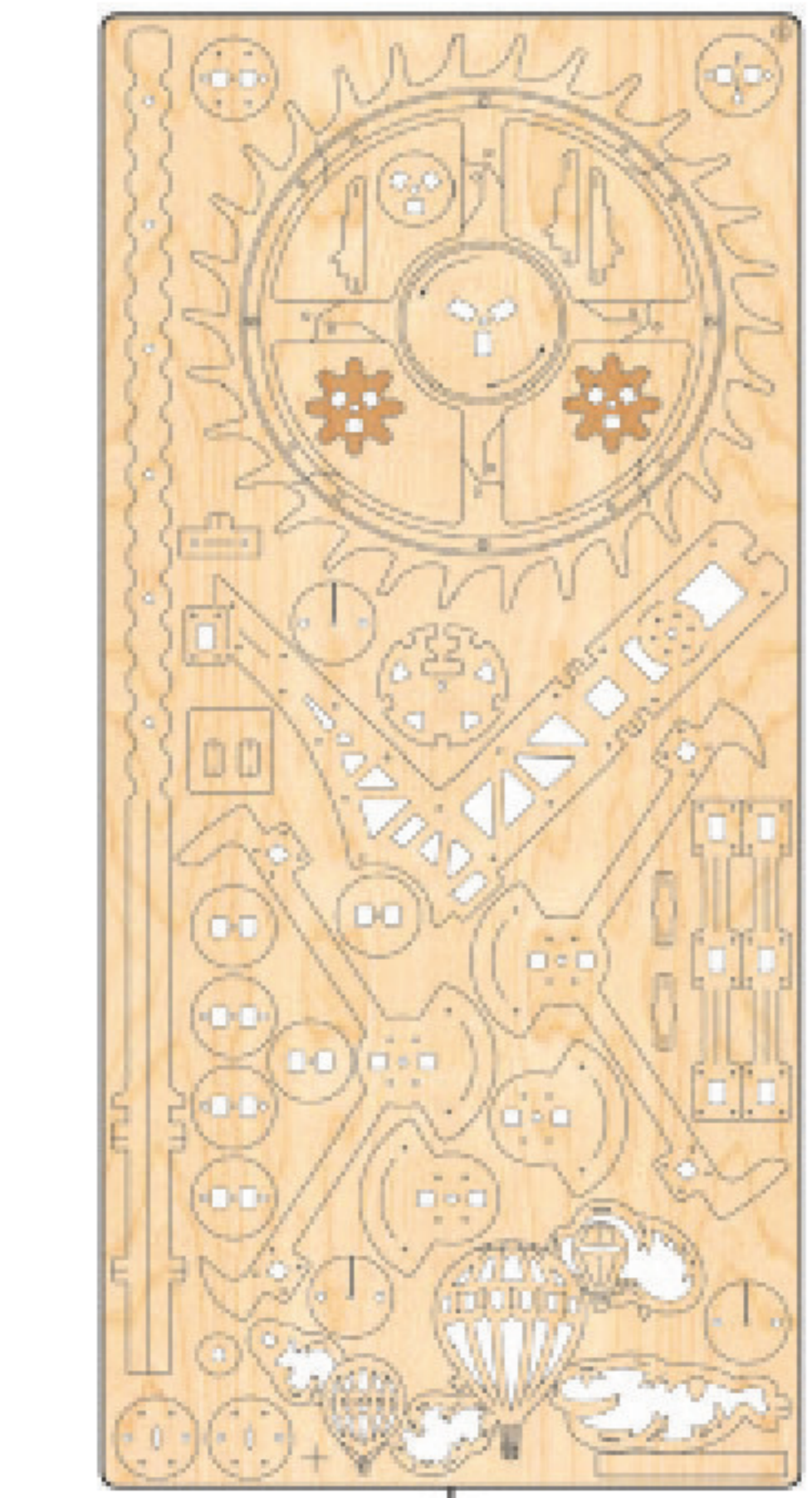

6

1

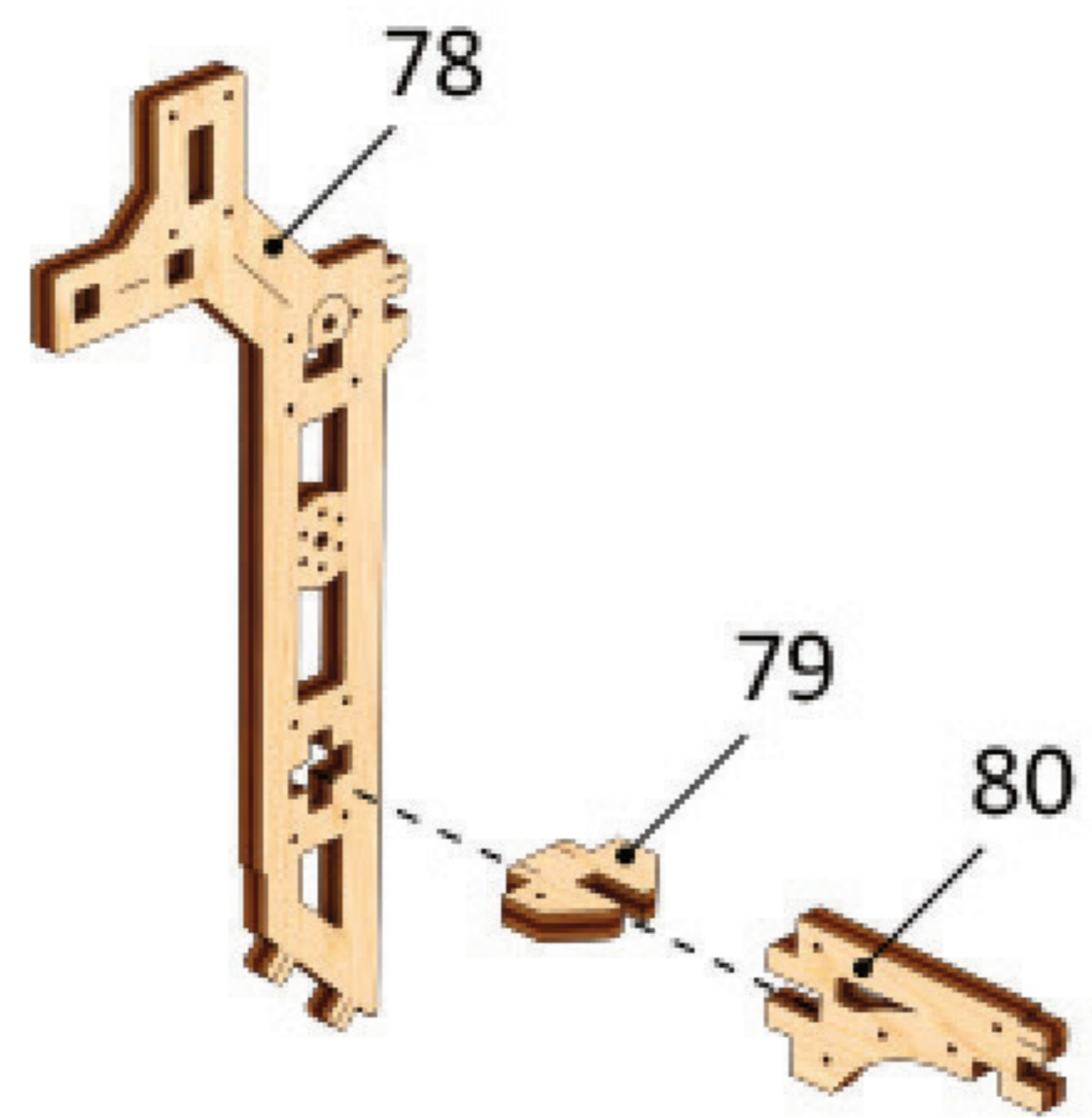

2

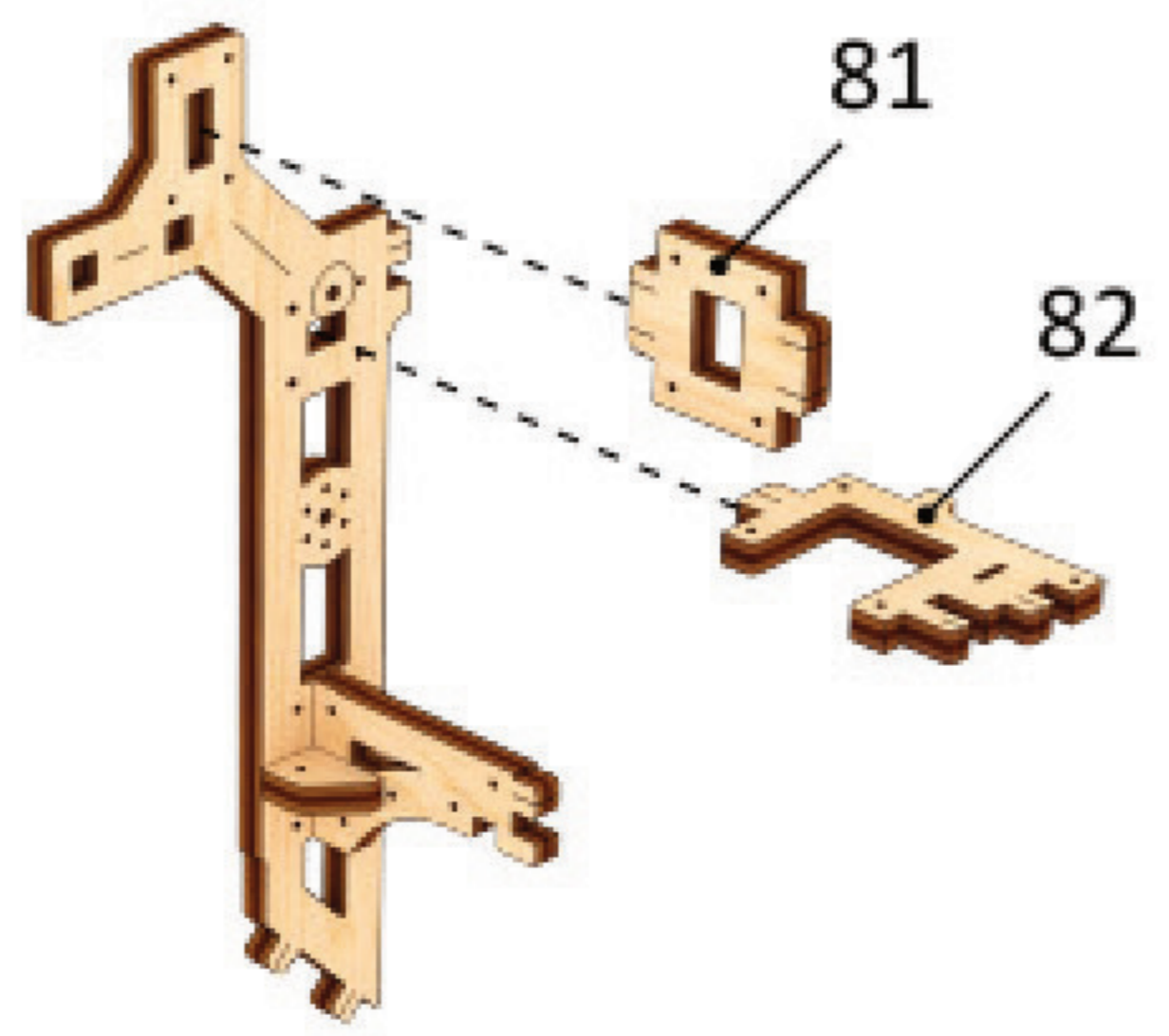

3

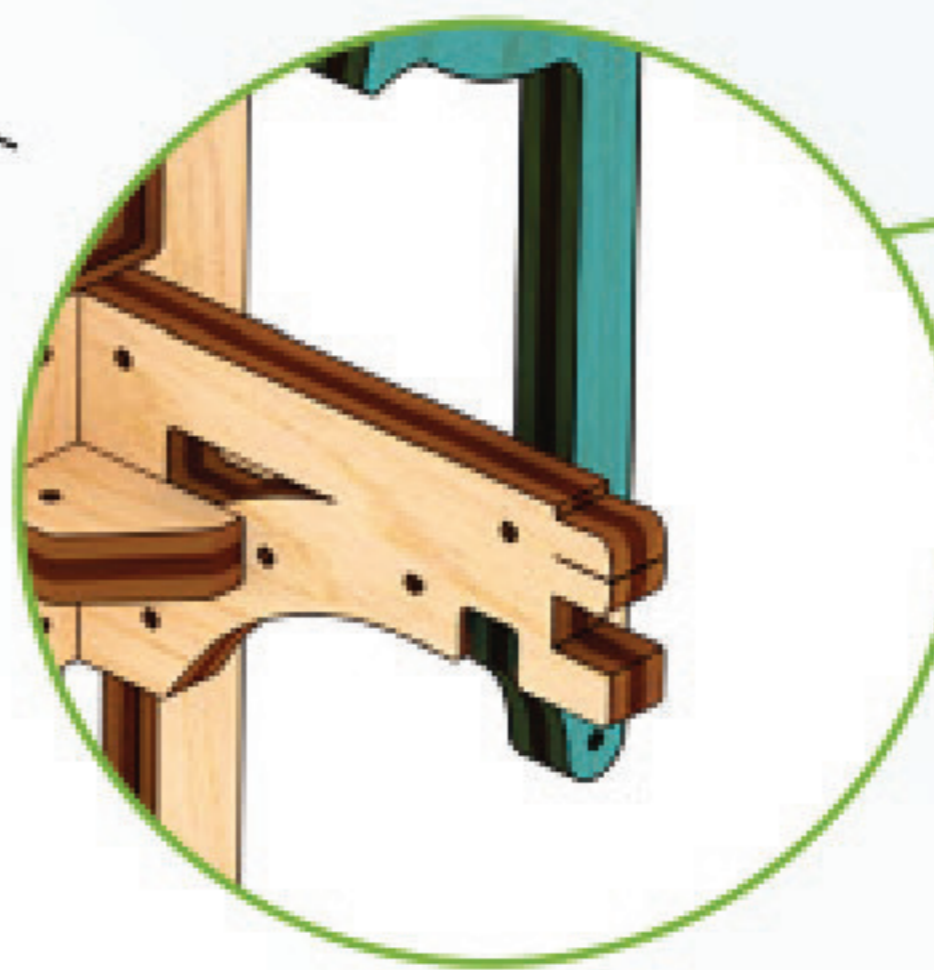
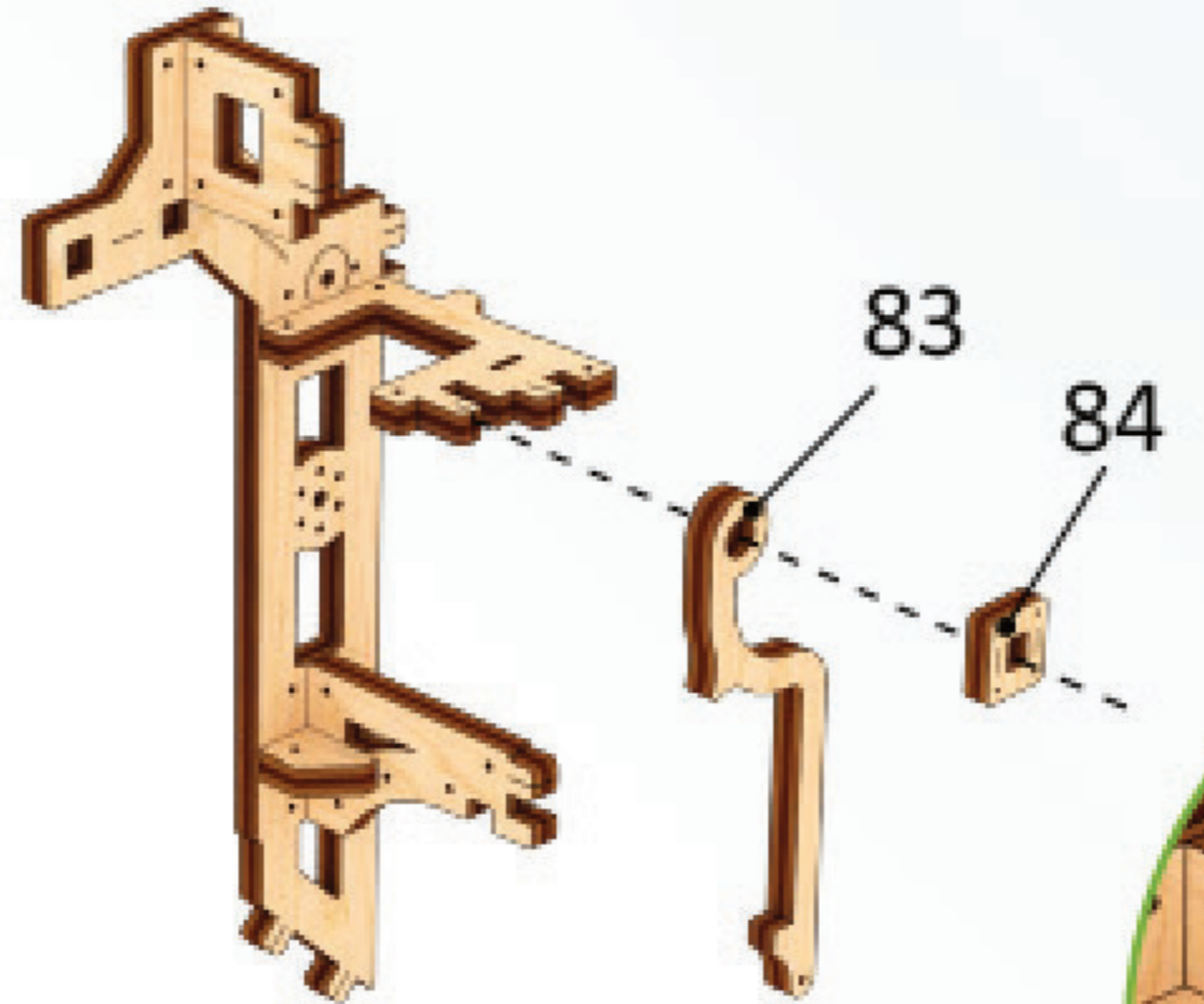

d4

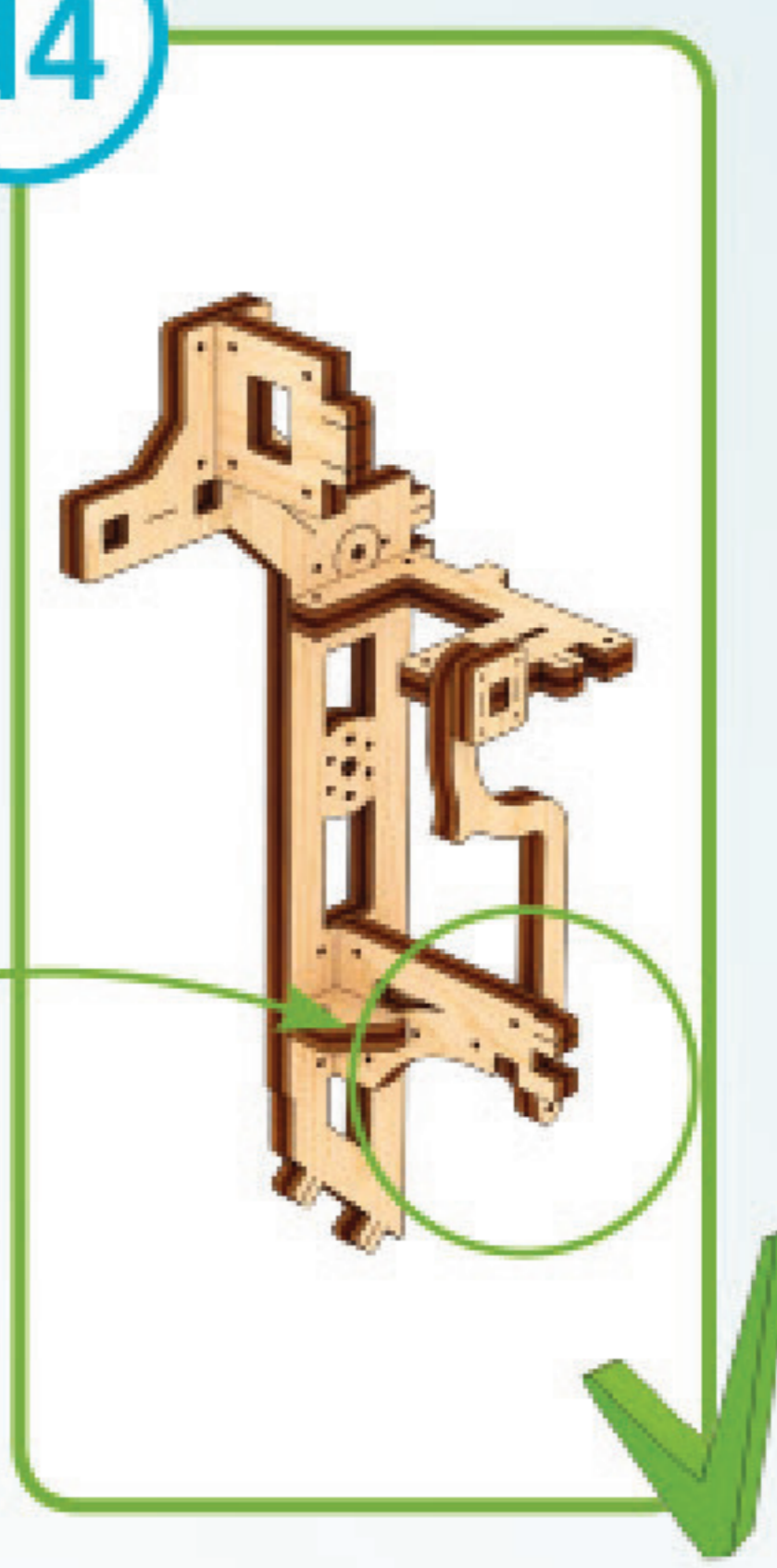

1

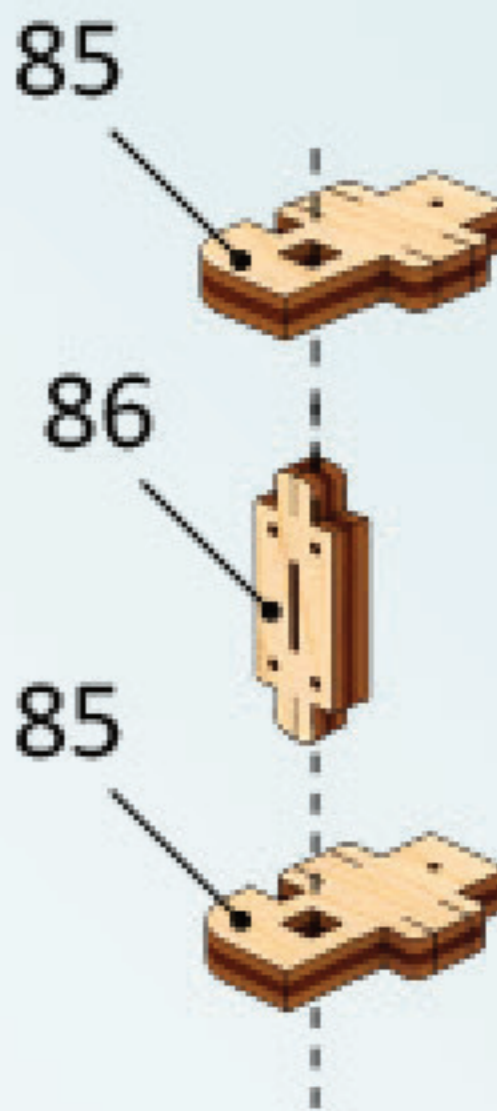

d5

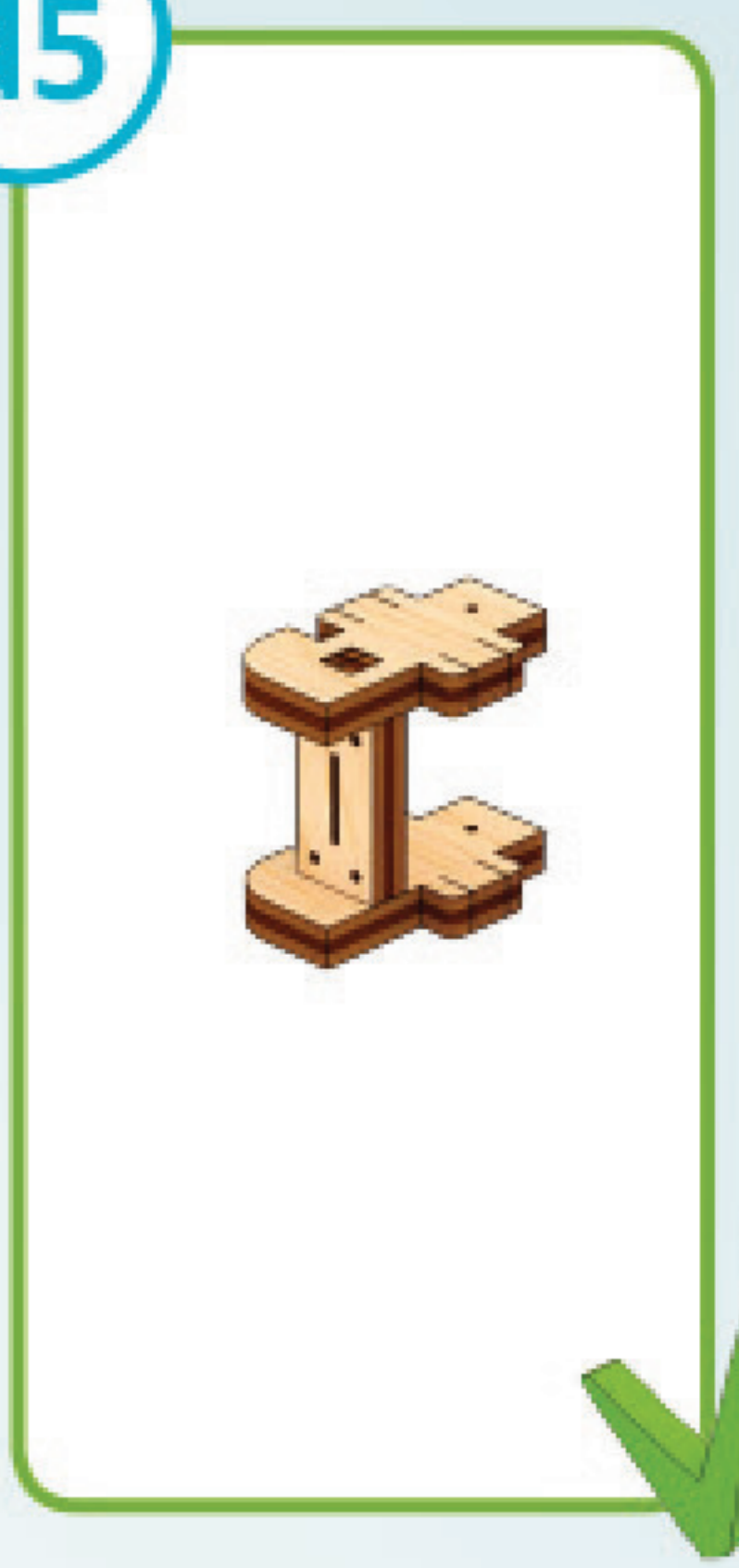

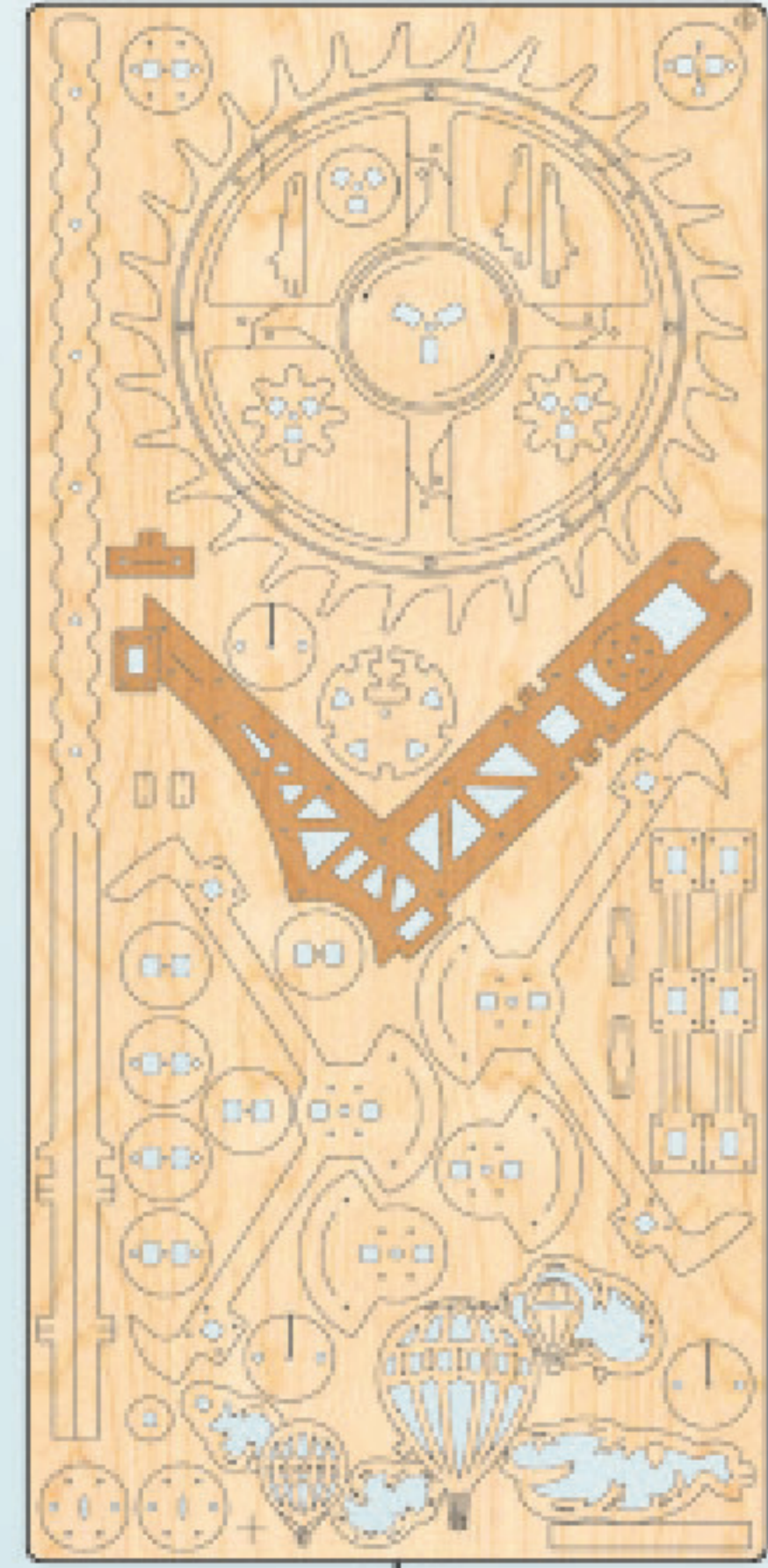

1

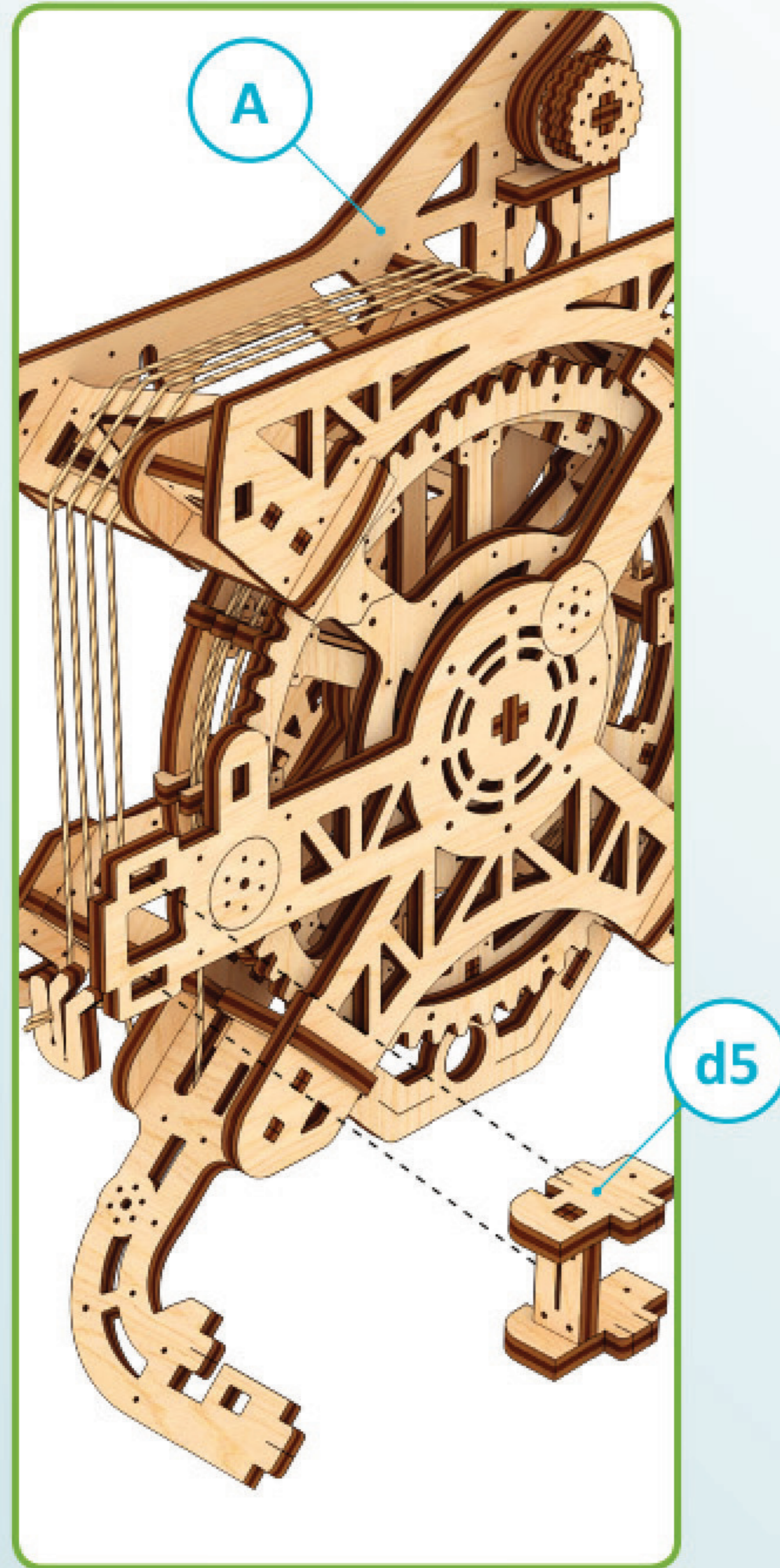

2

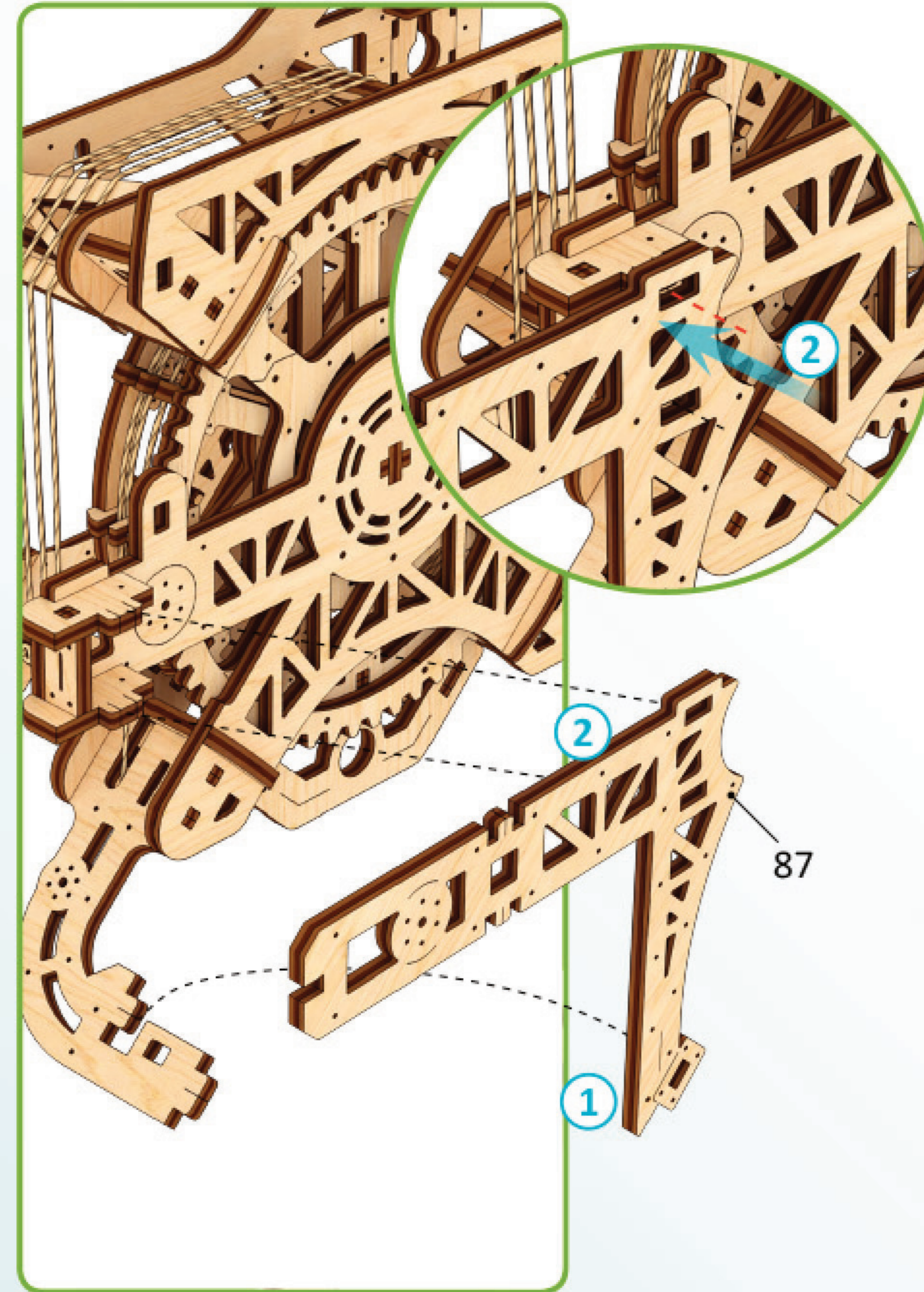

3

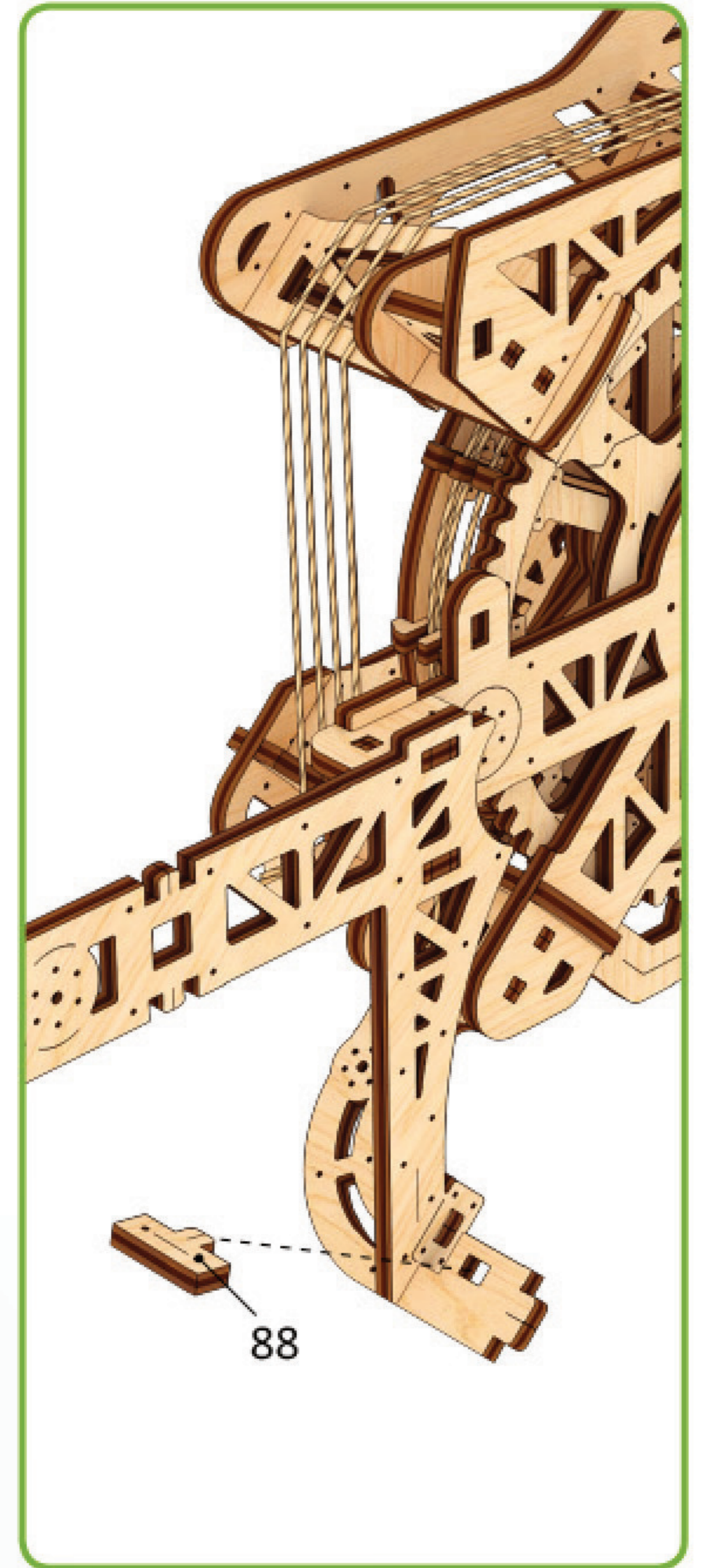

4

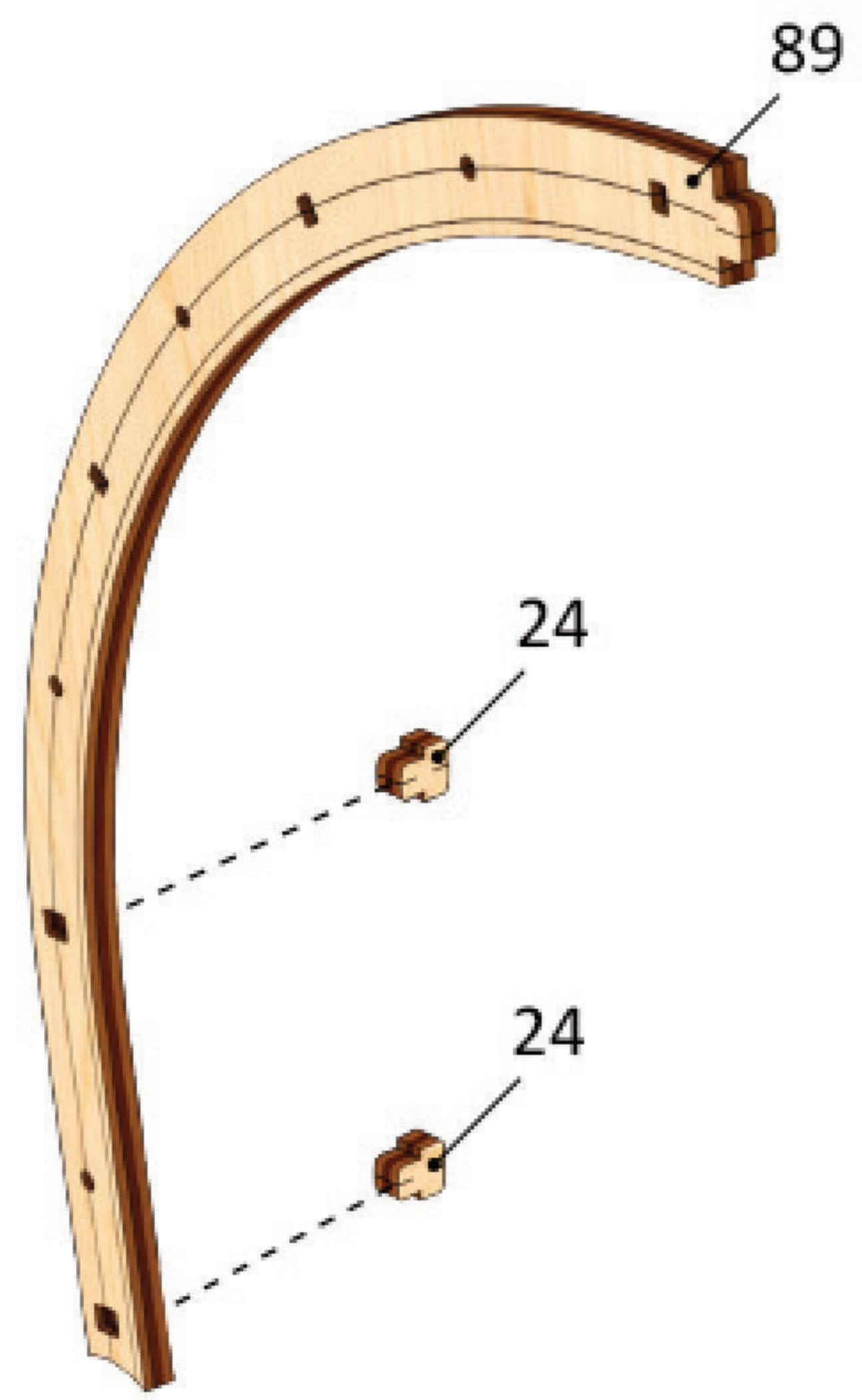
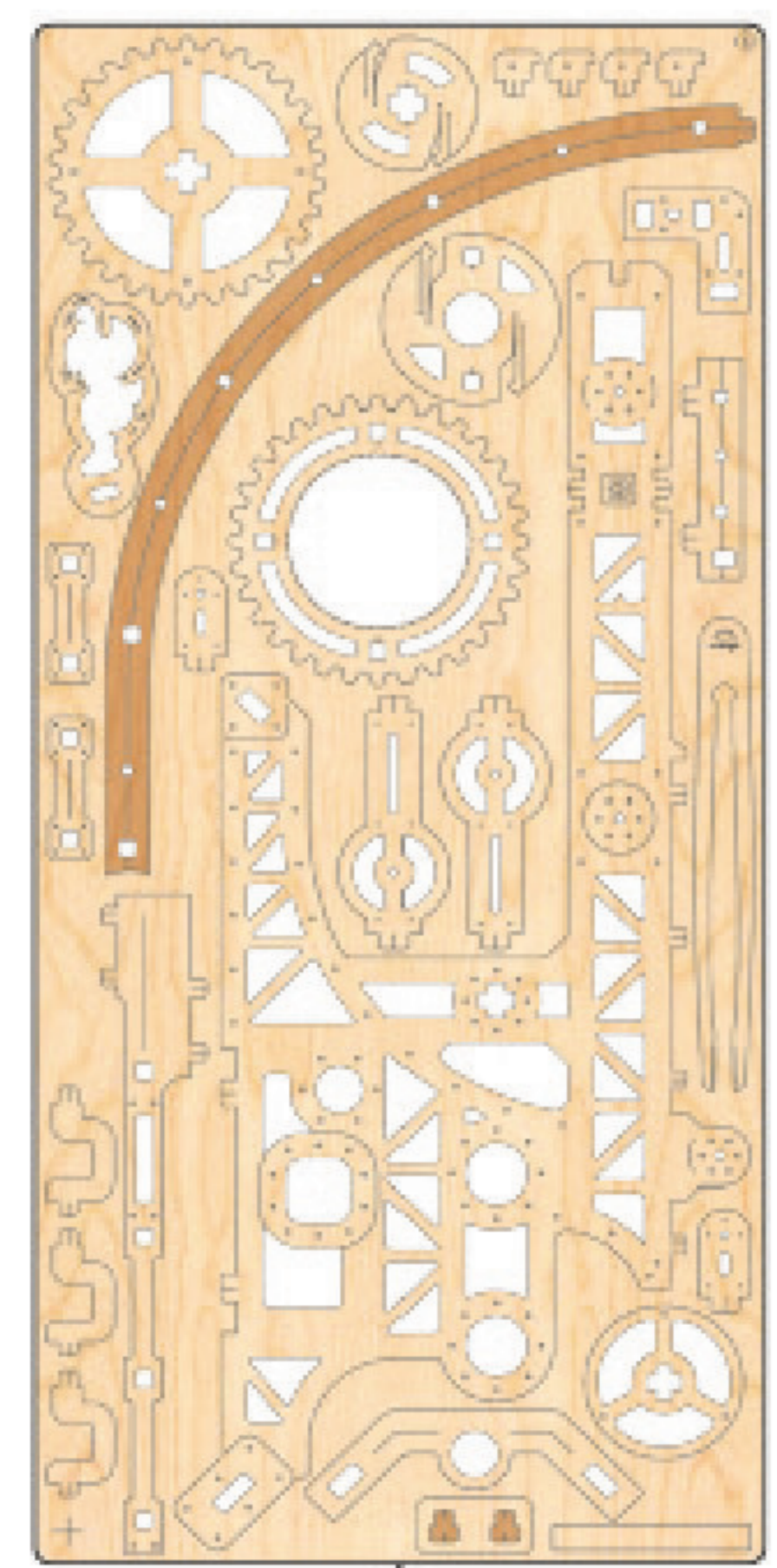

5

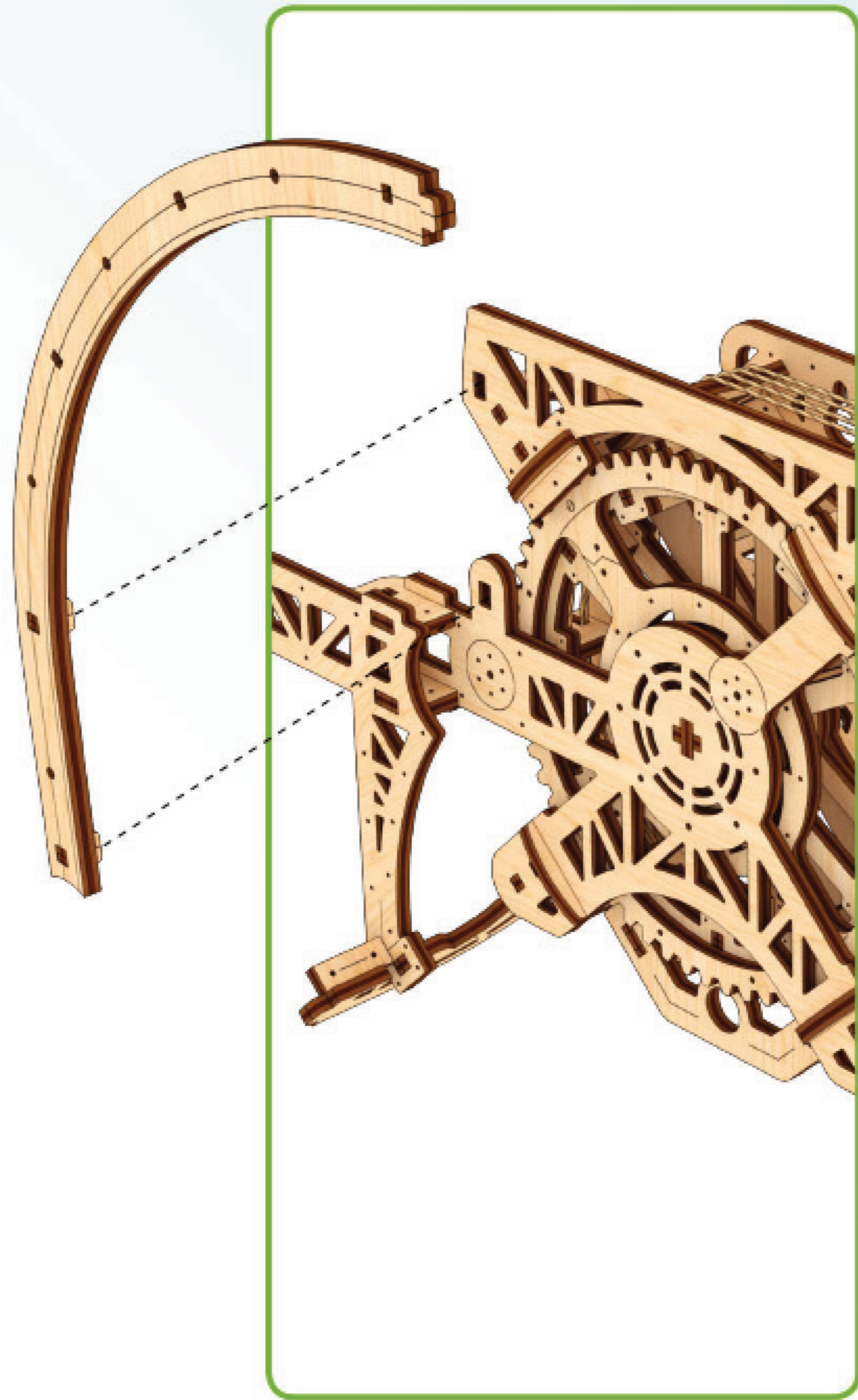

6

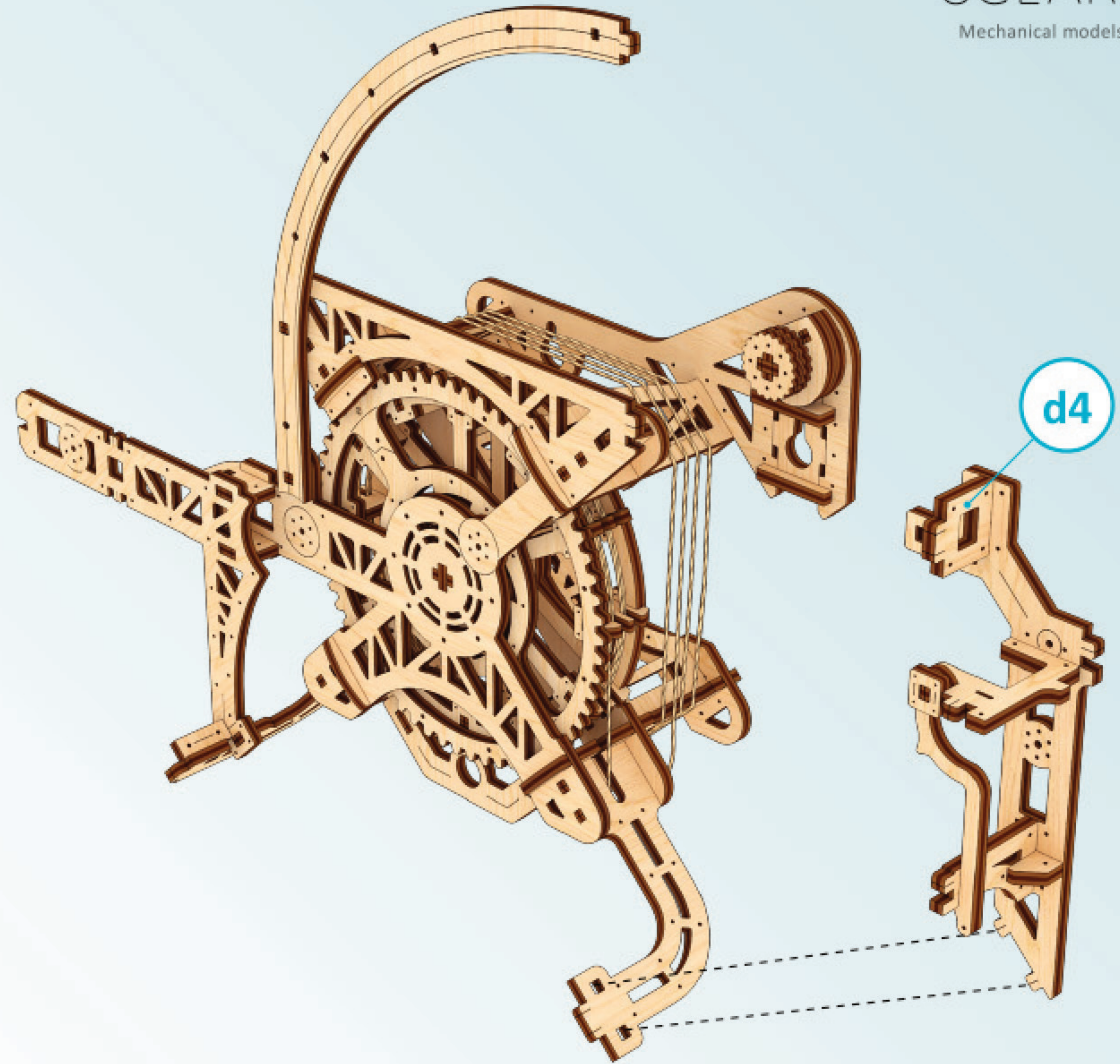

7

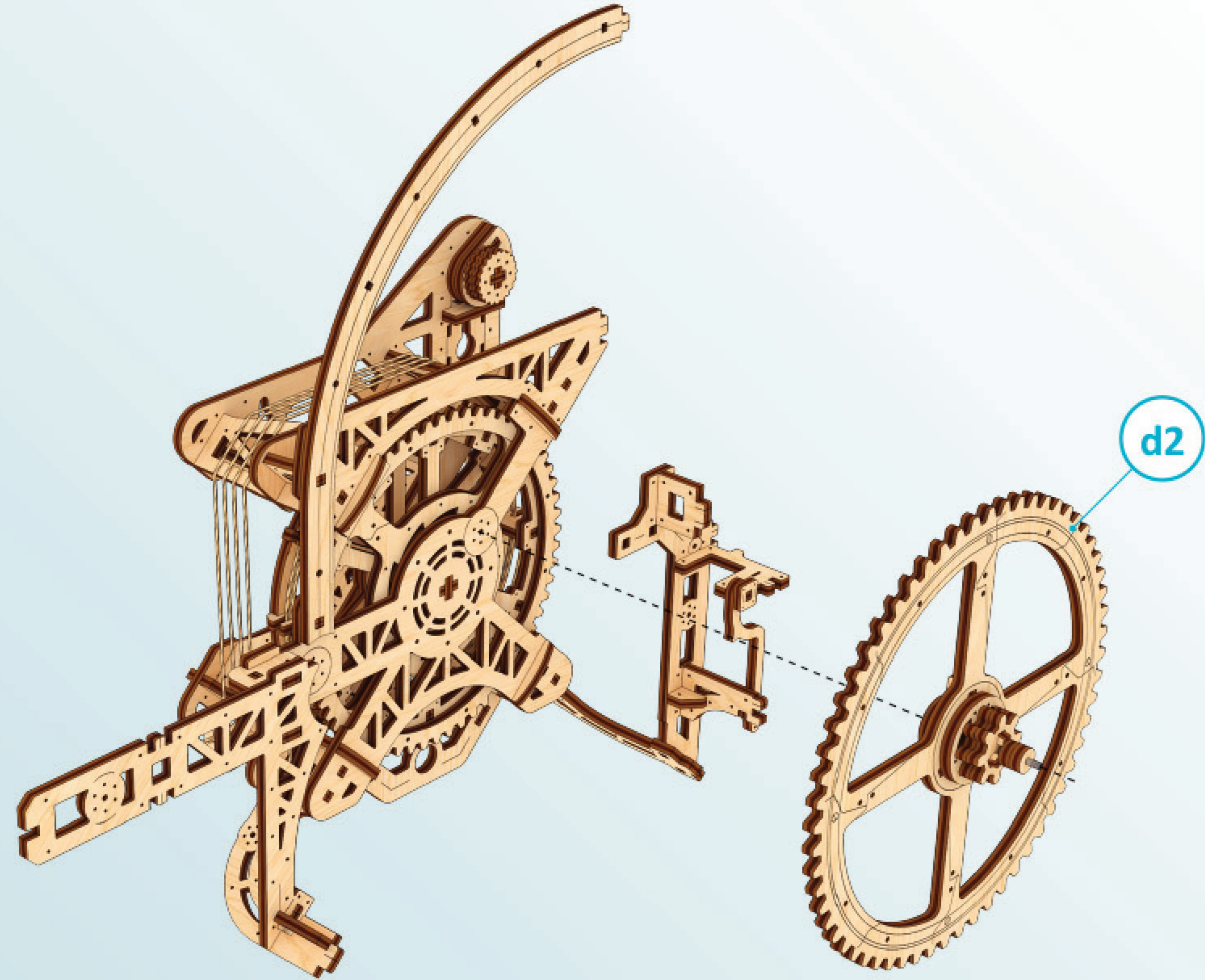

8

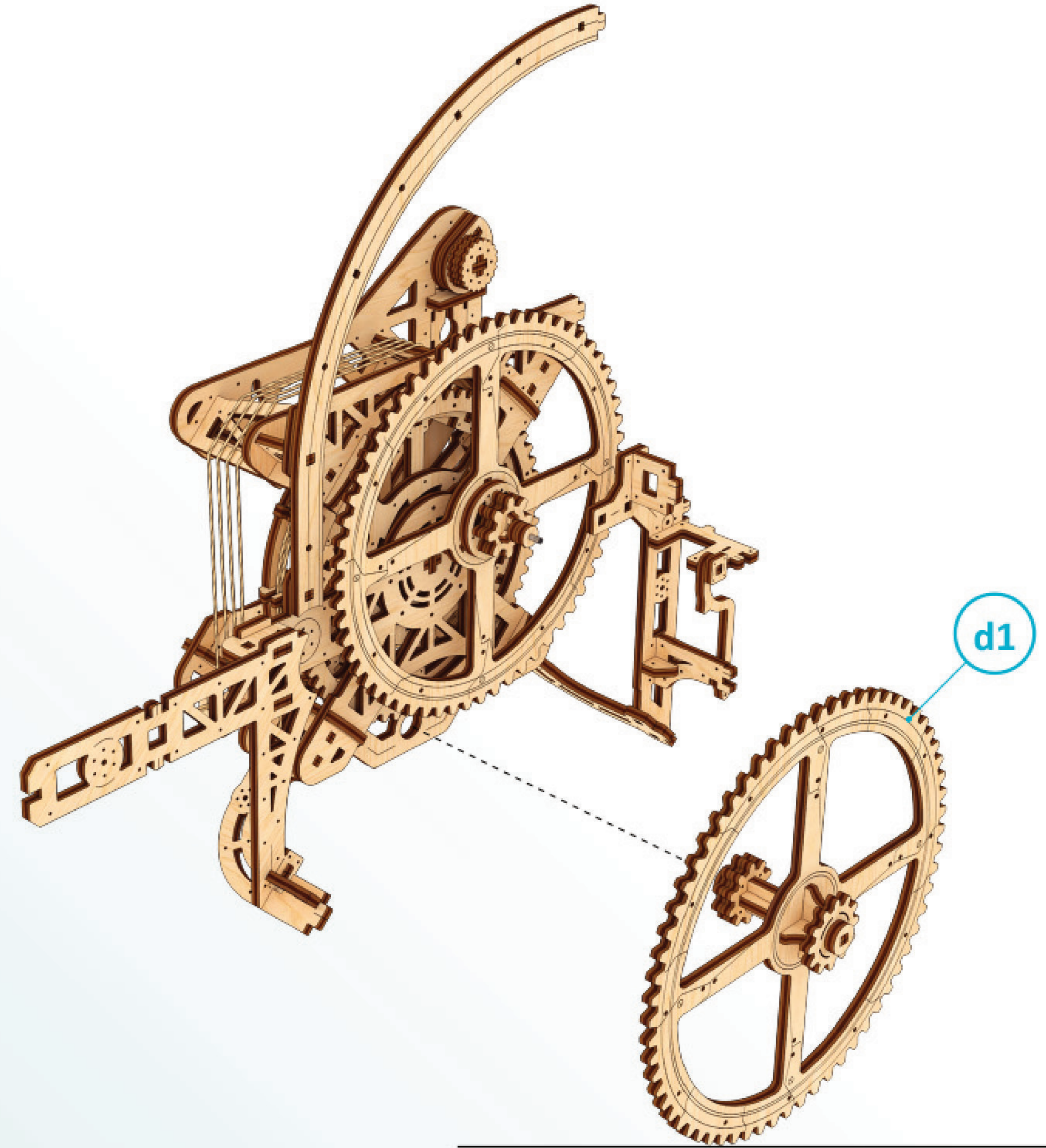

9

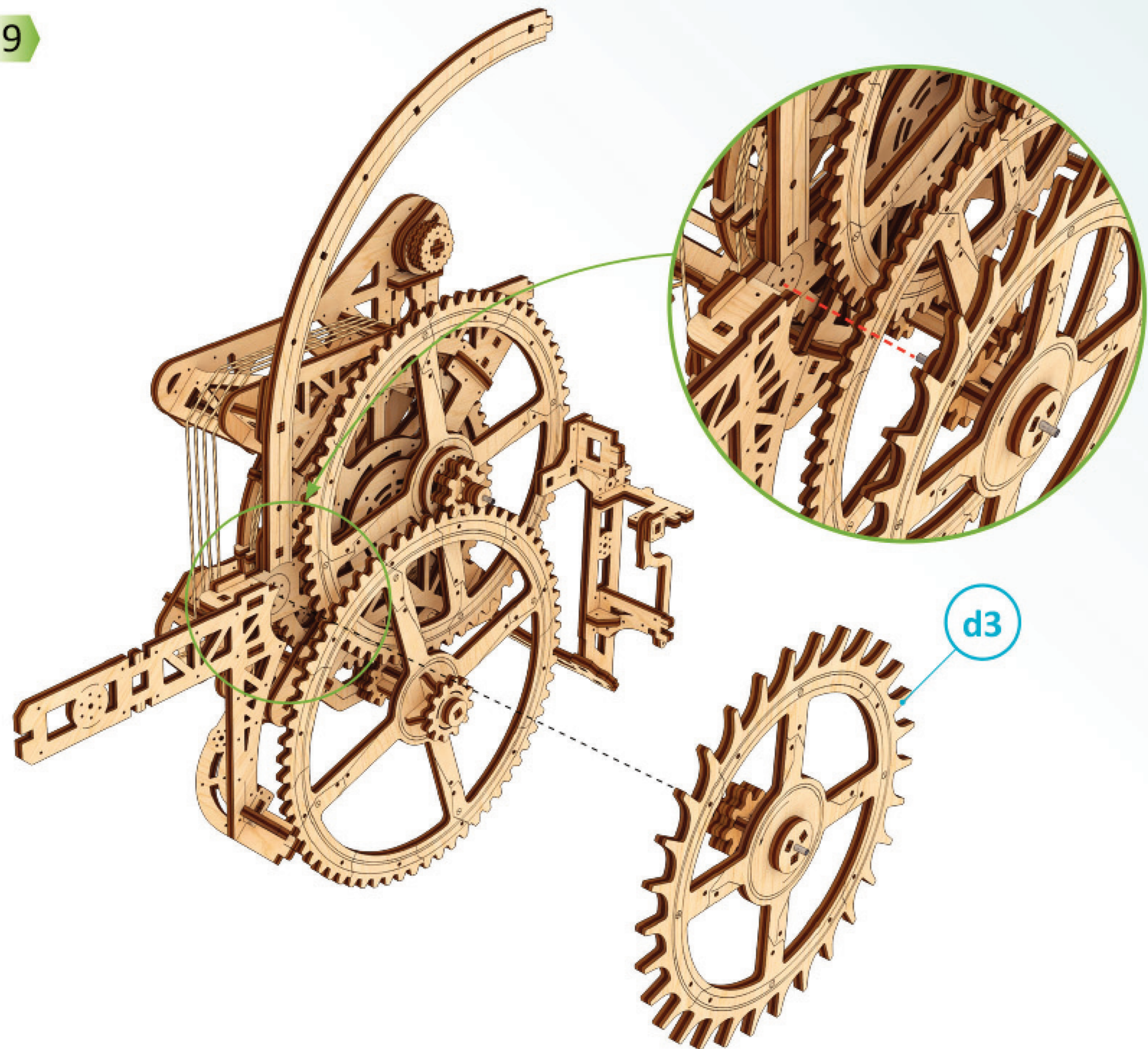

10

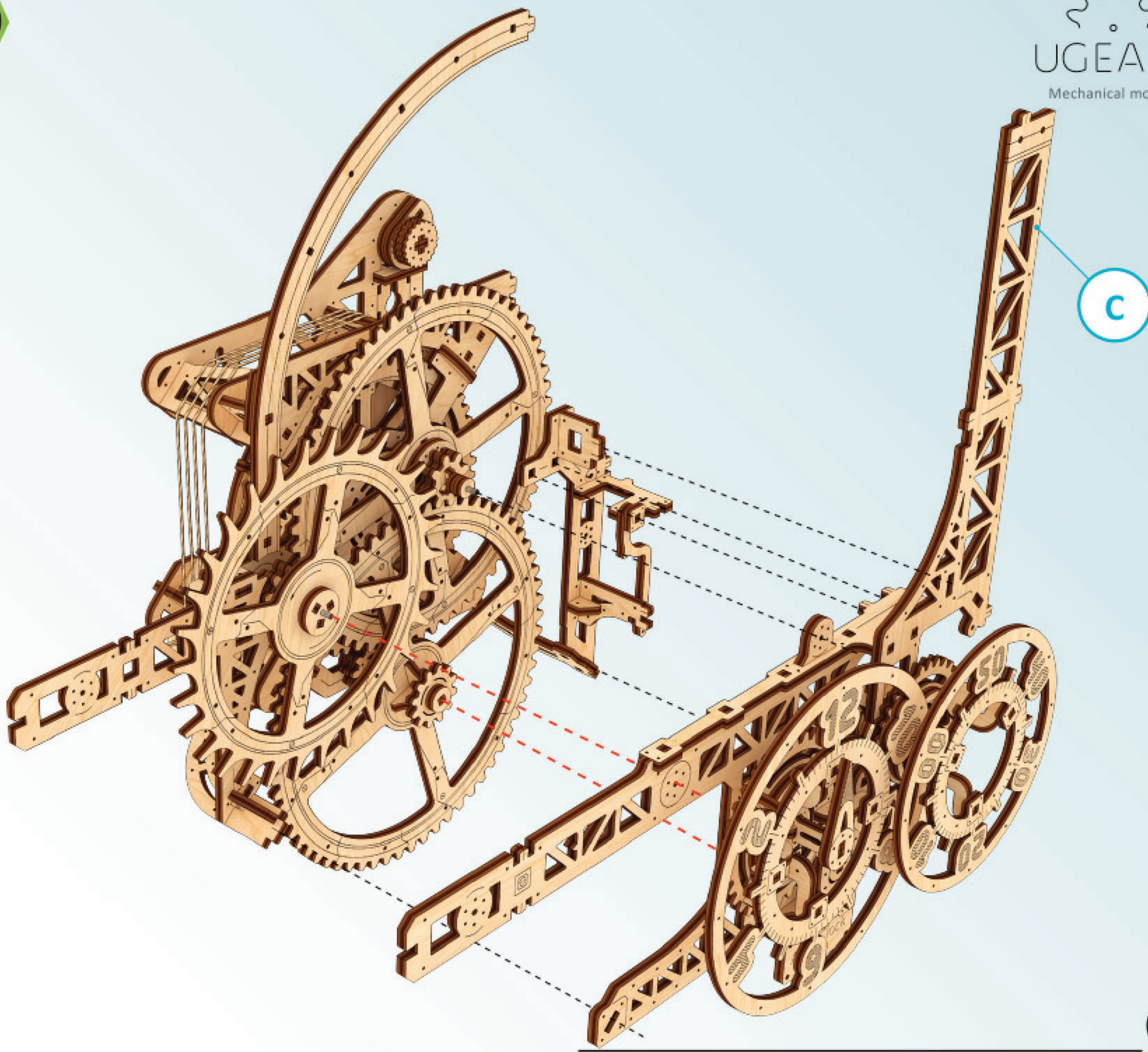

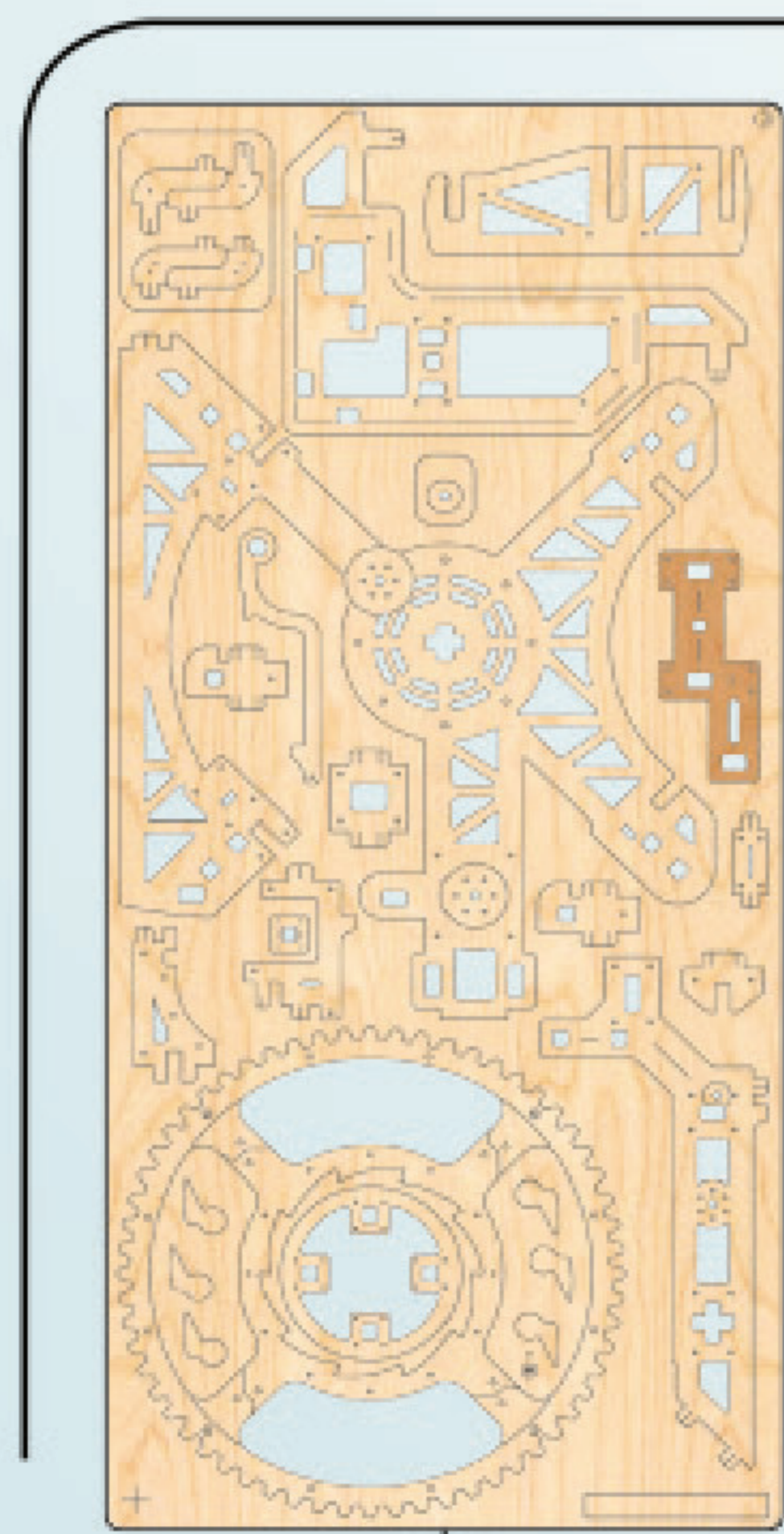

3

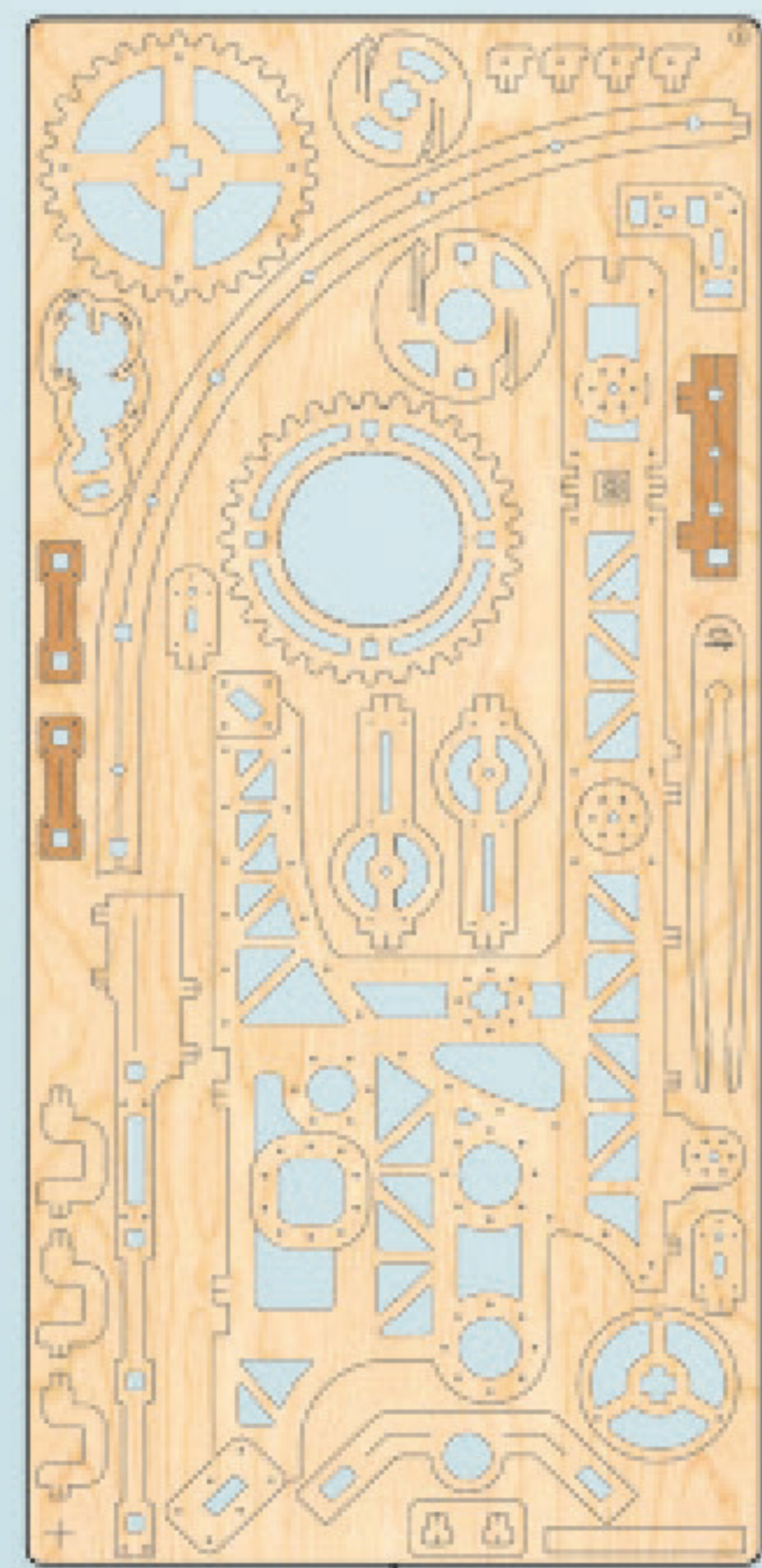

4

11

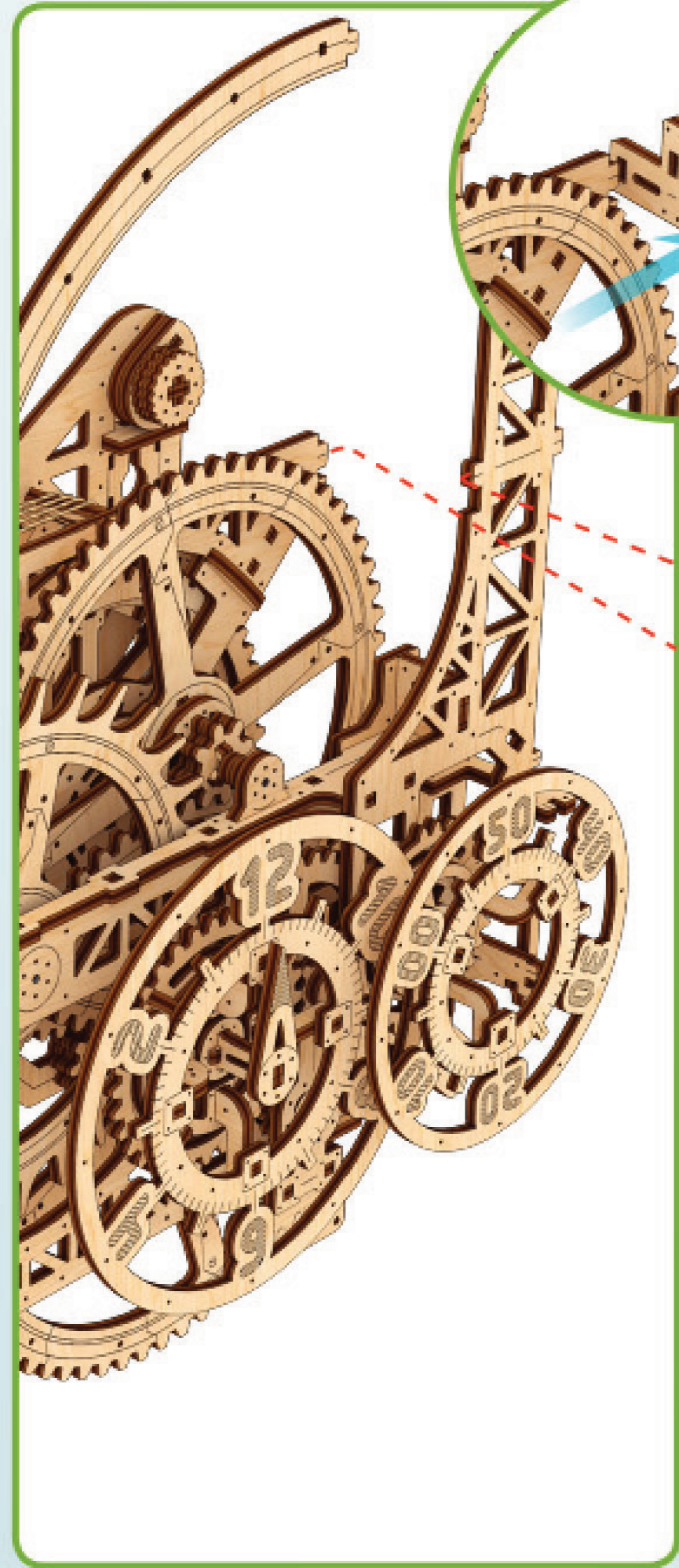

12

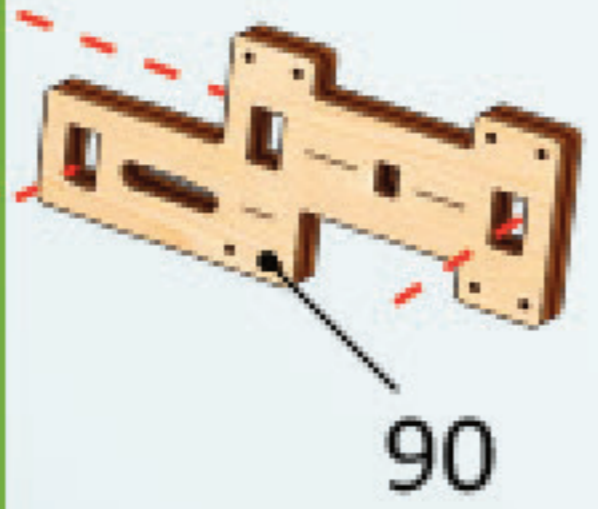

90

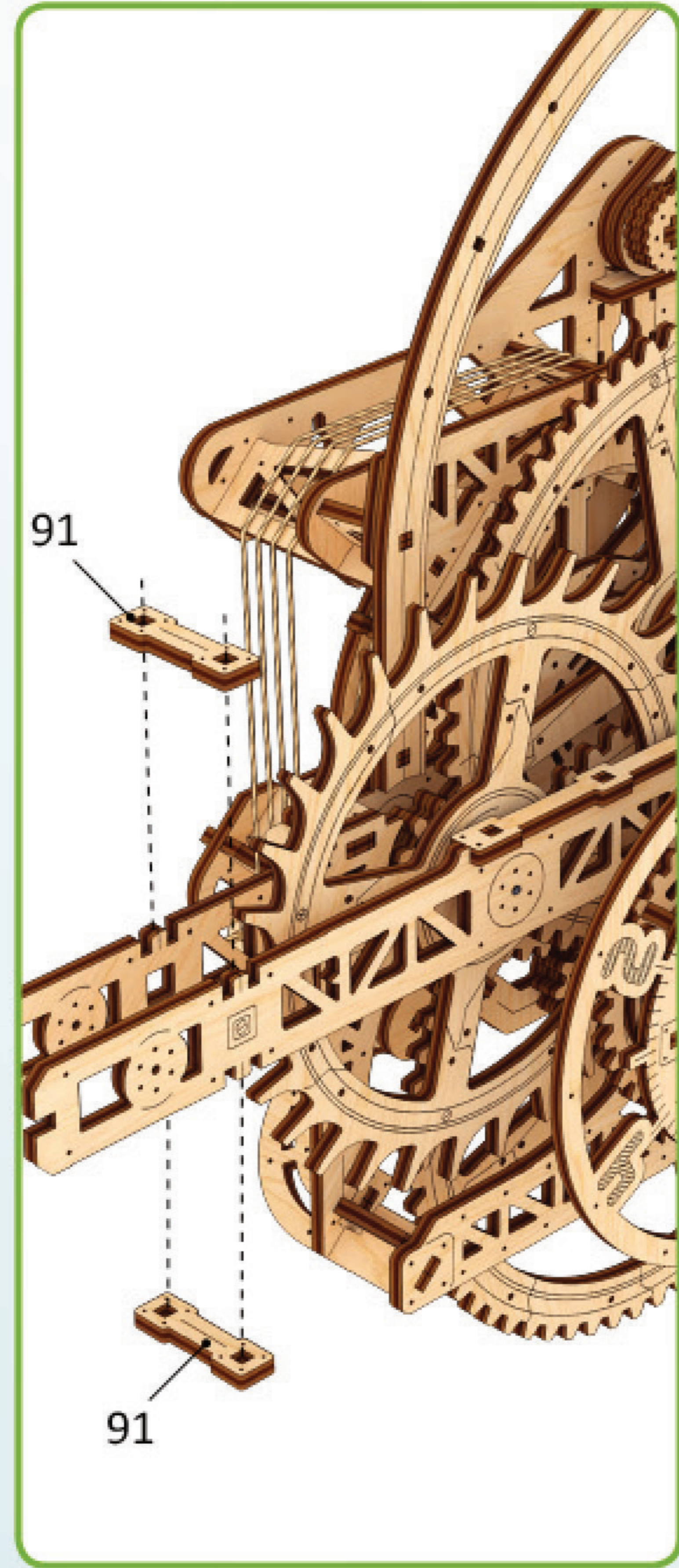

91

91

13



92

D

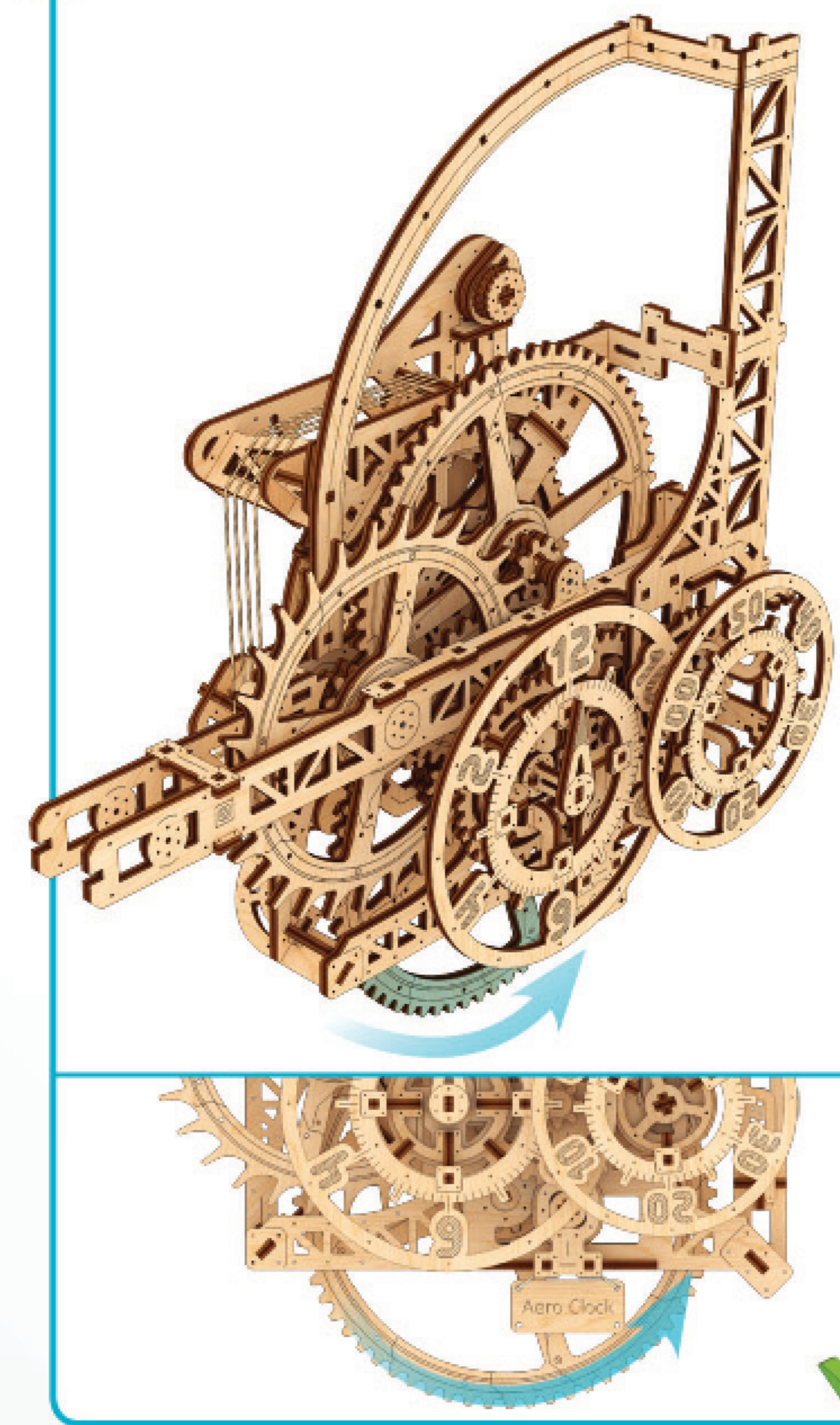

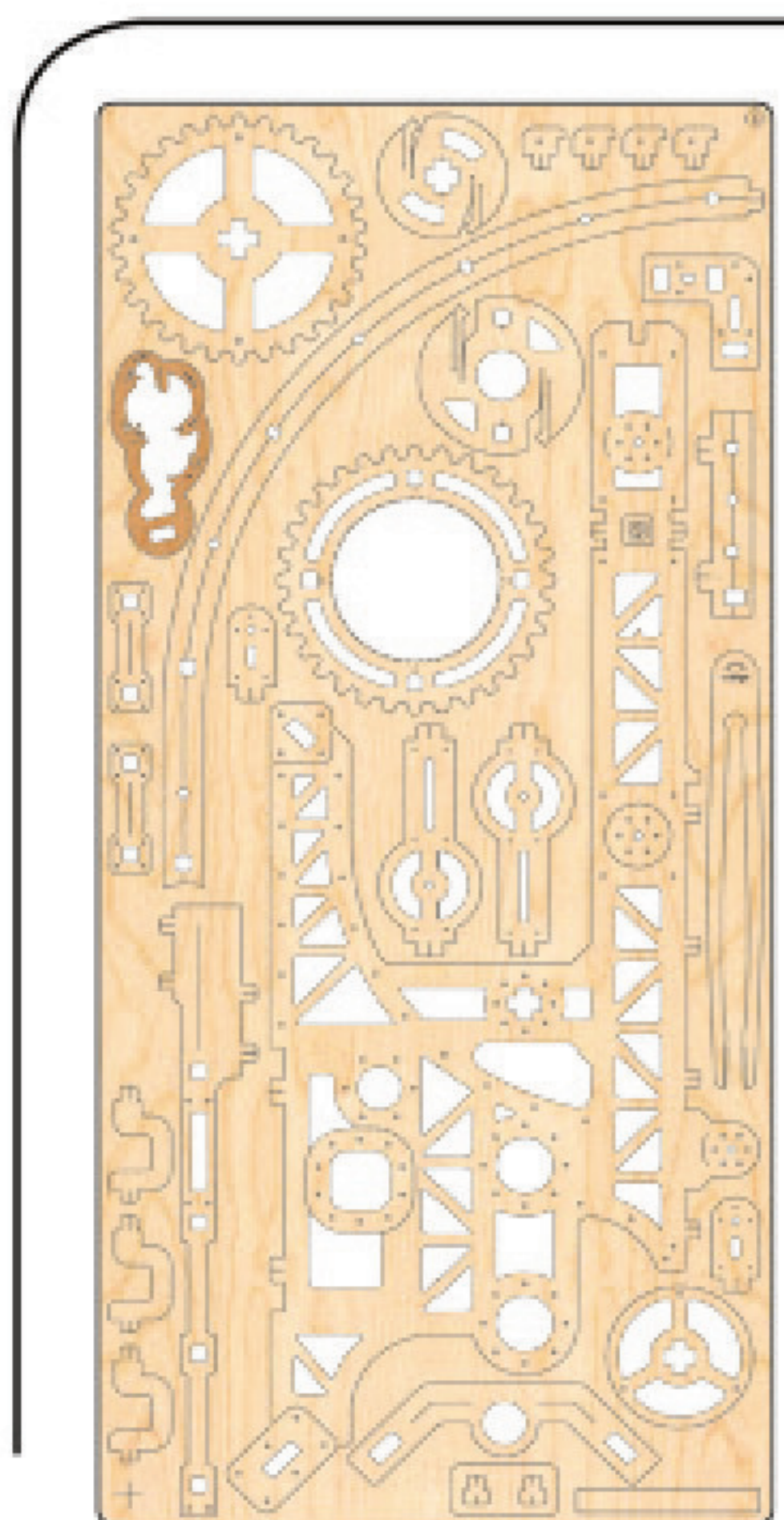

1

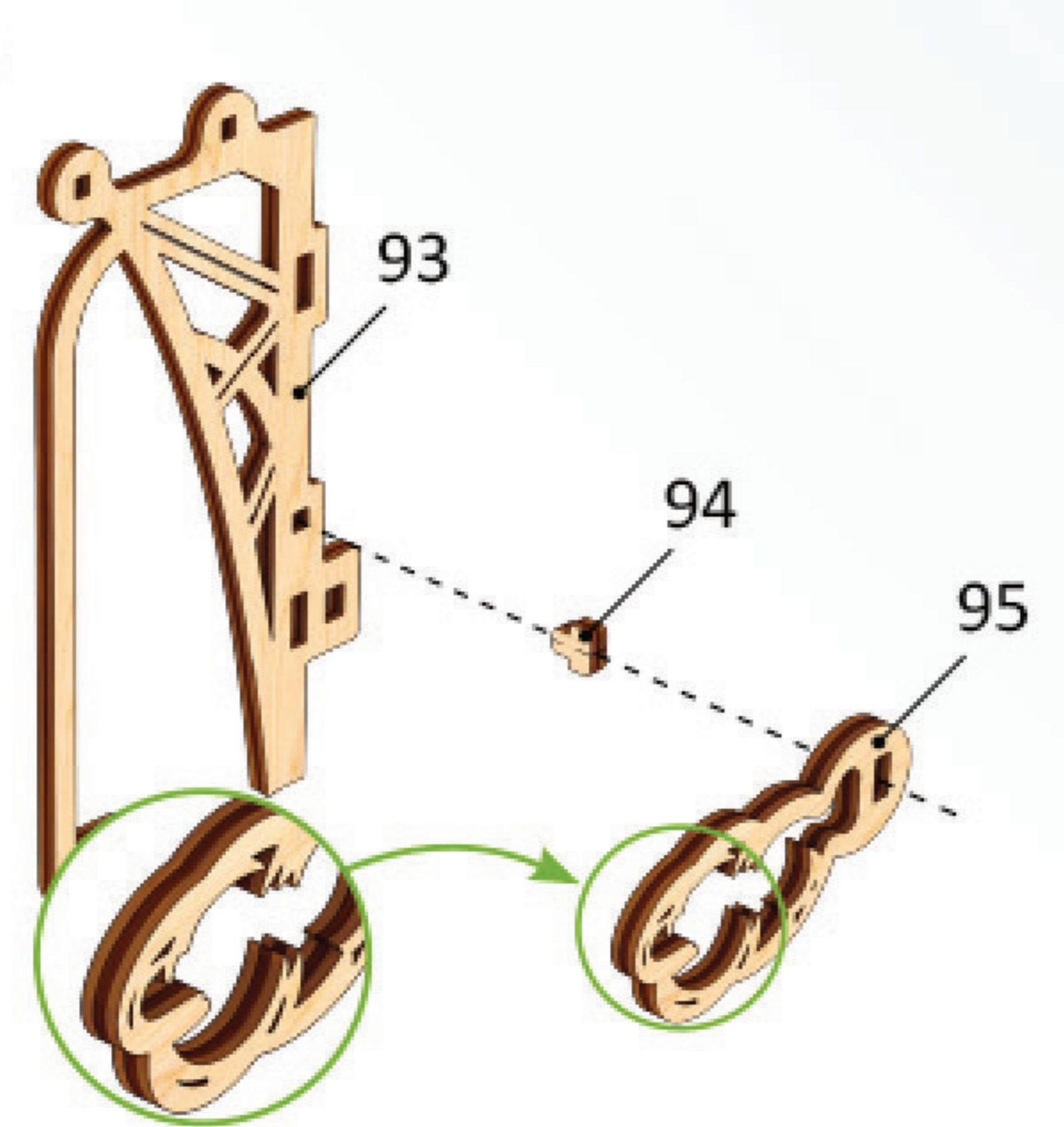

2

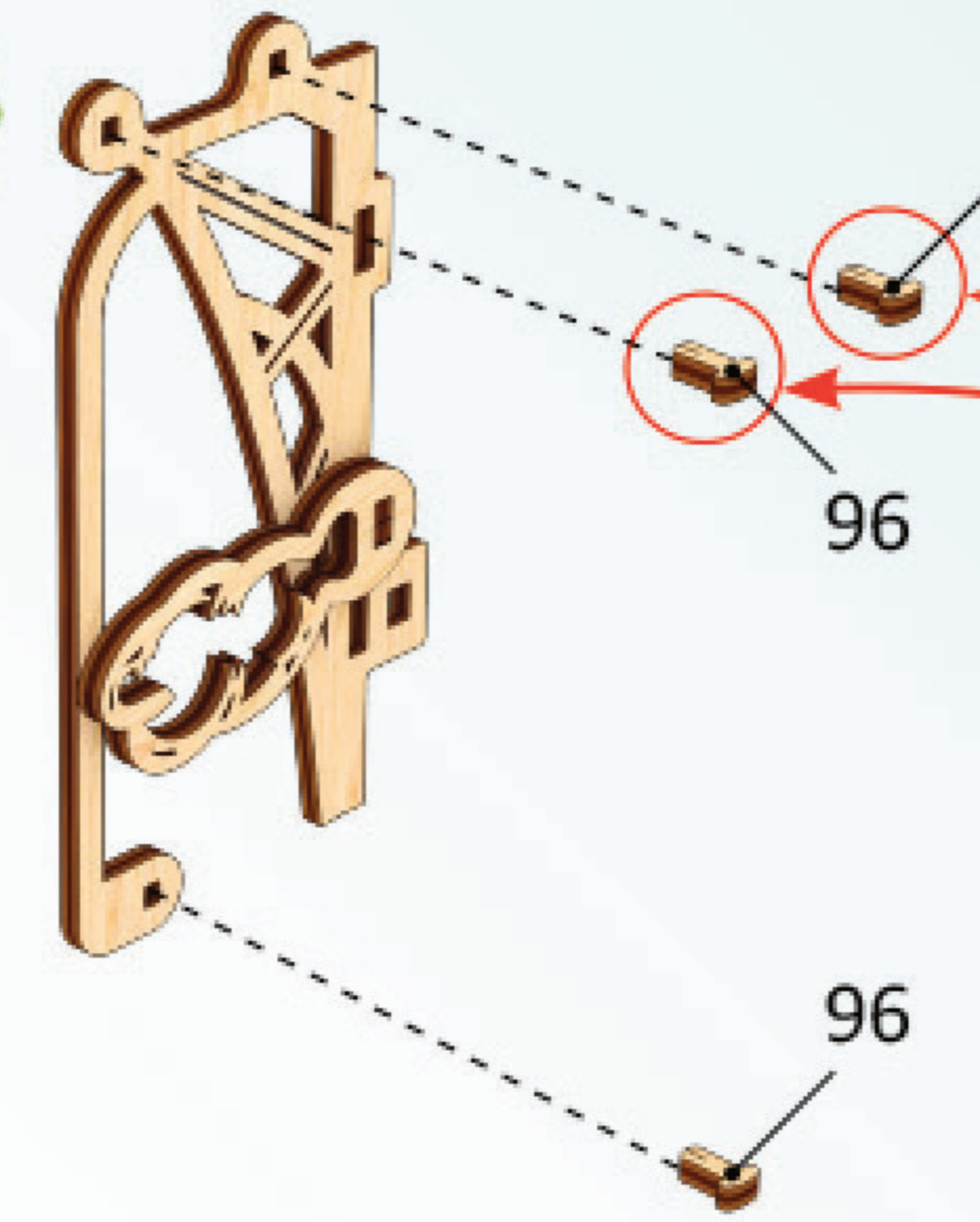

3

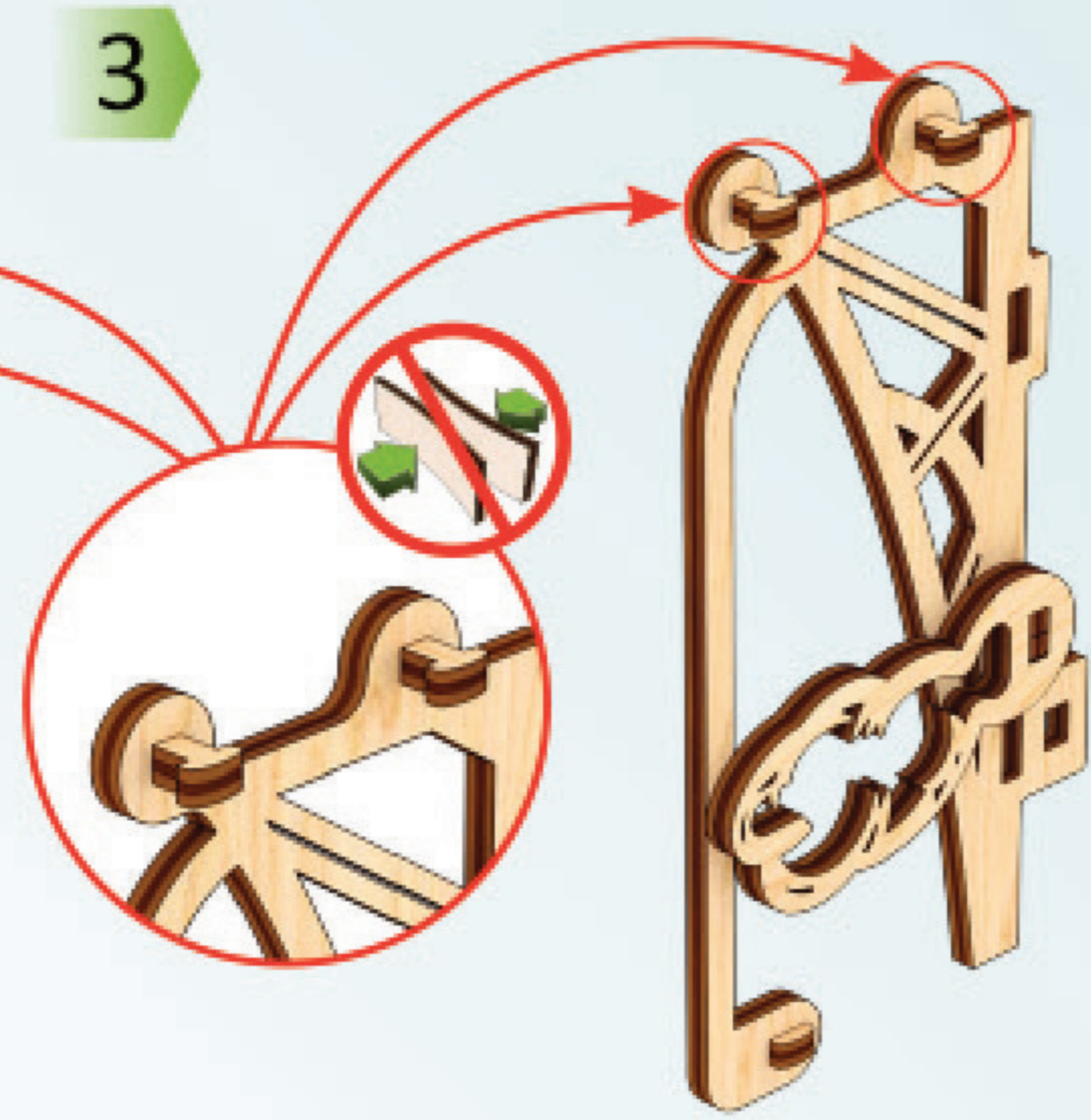

4

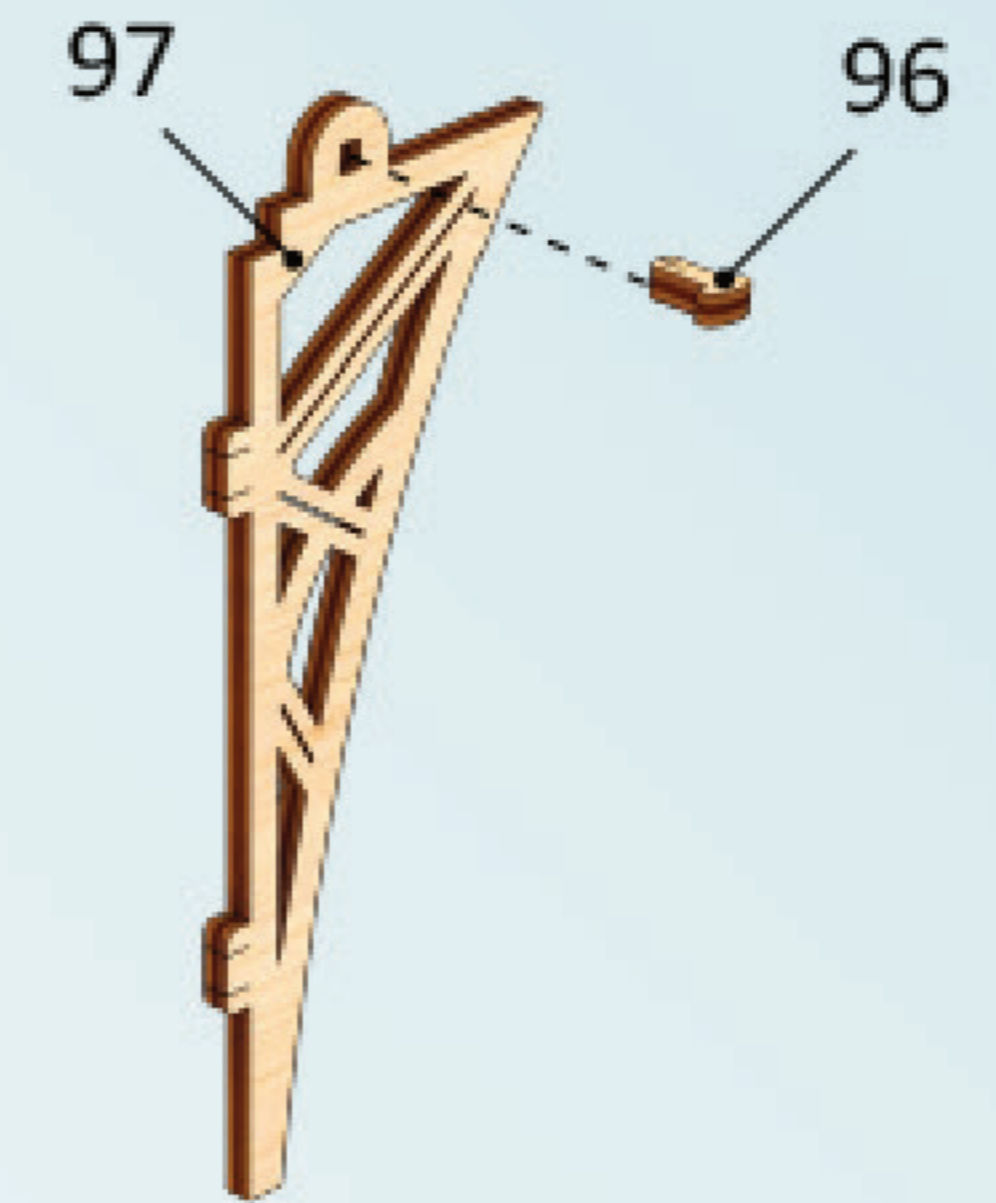

5

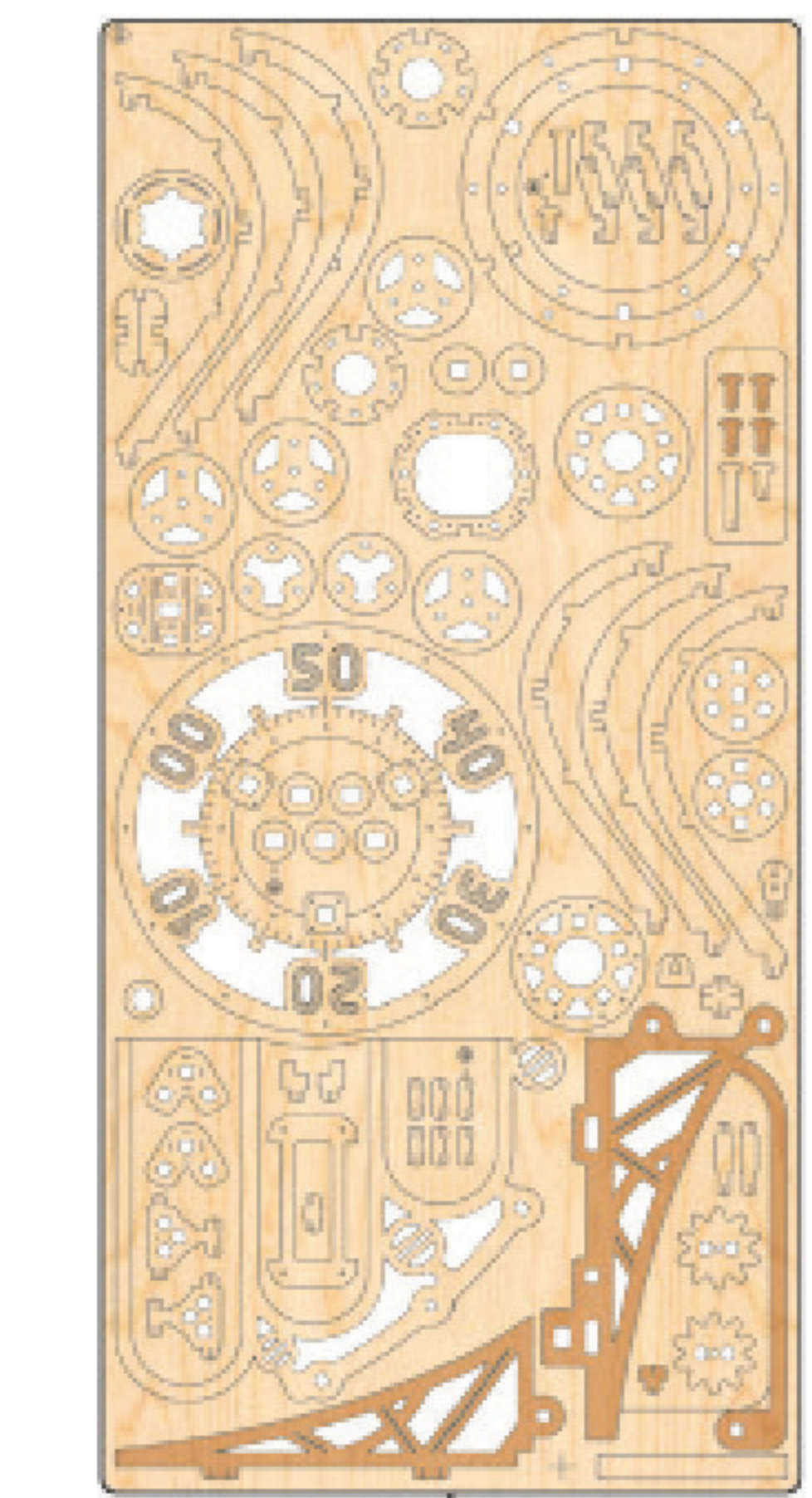
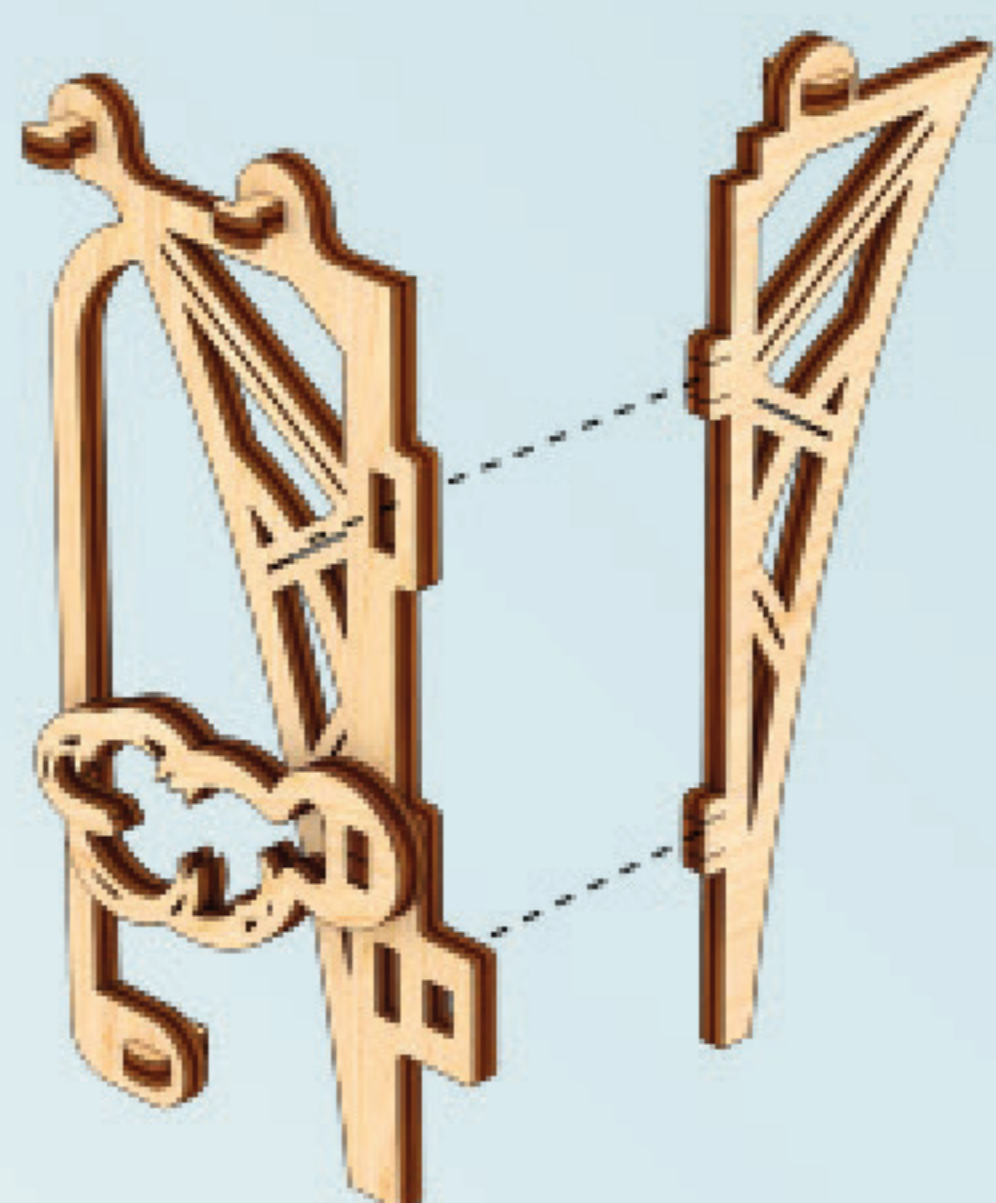

6

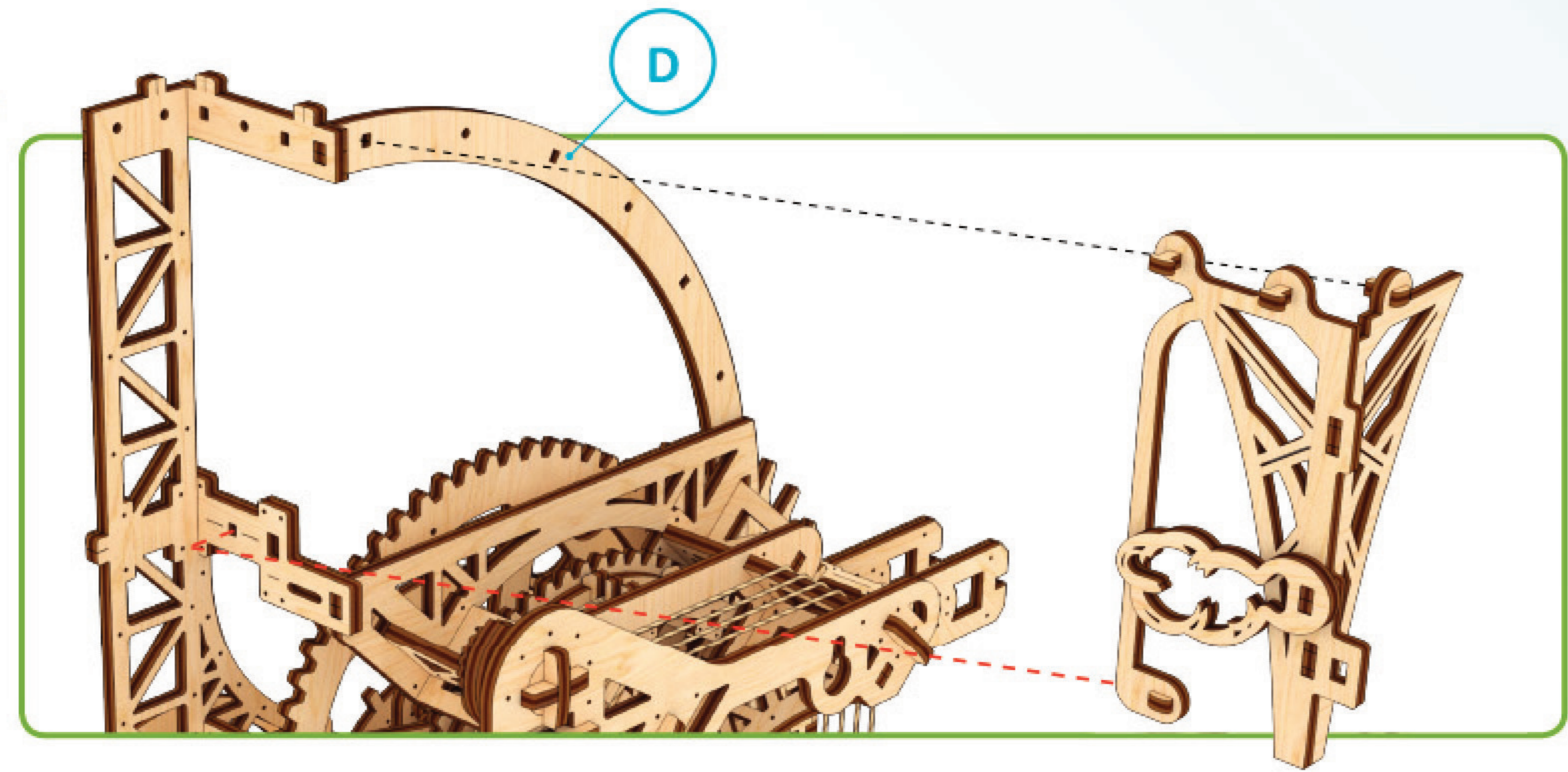

7

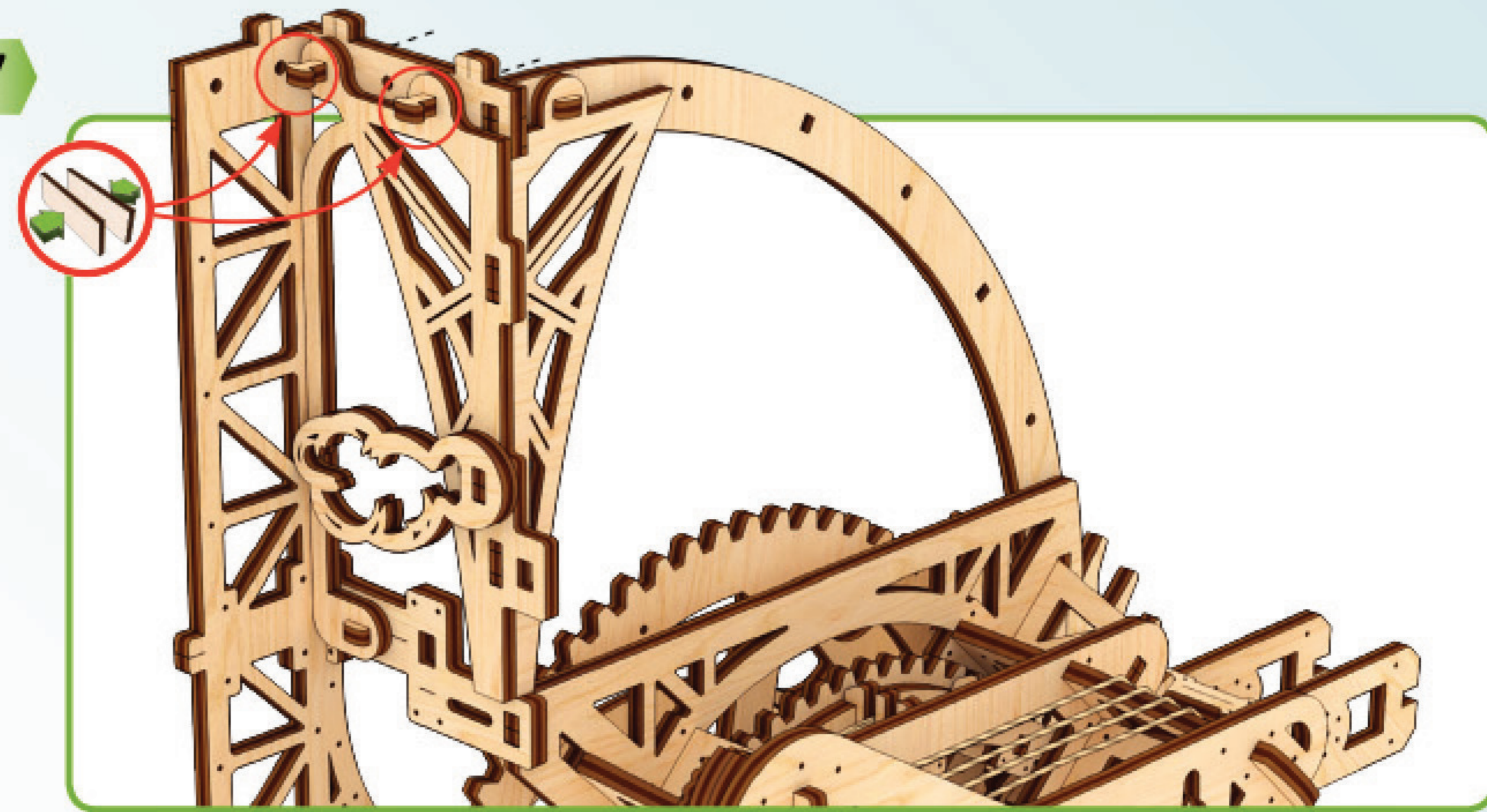

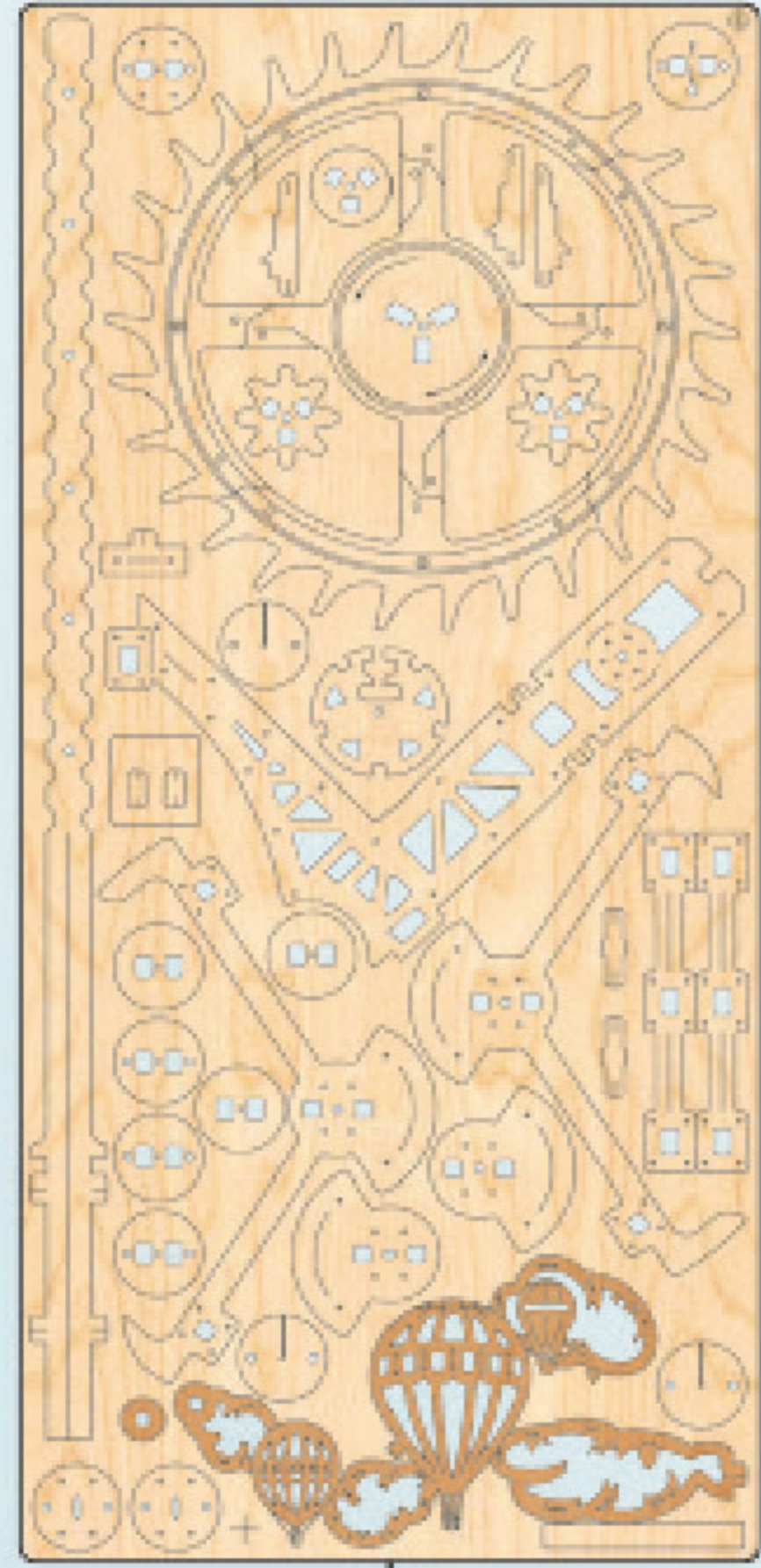

6

8

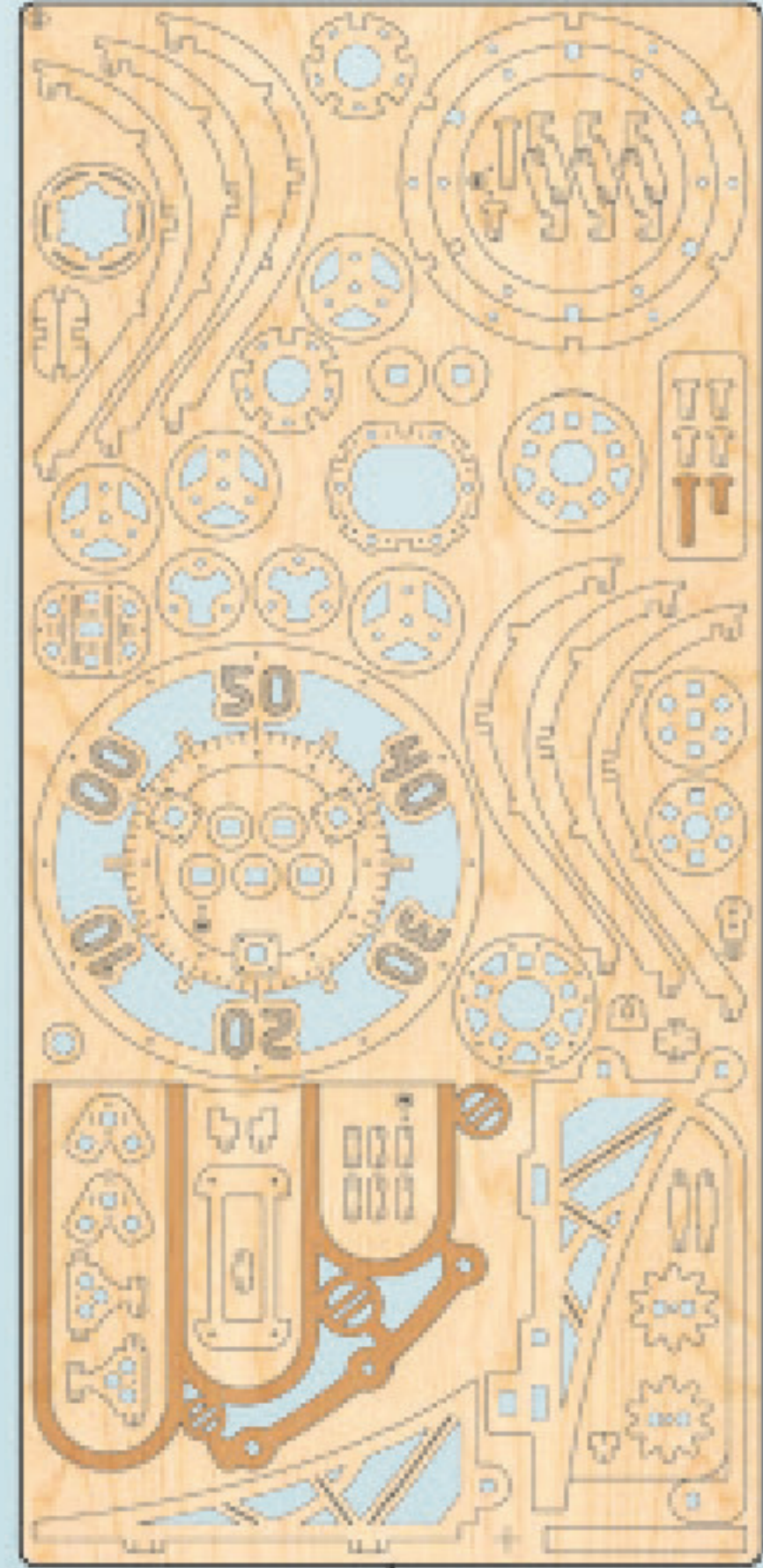
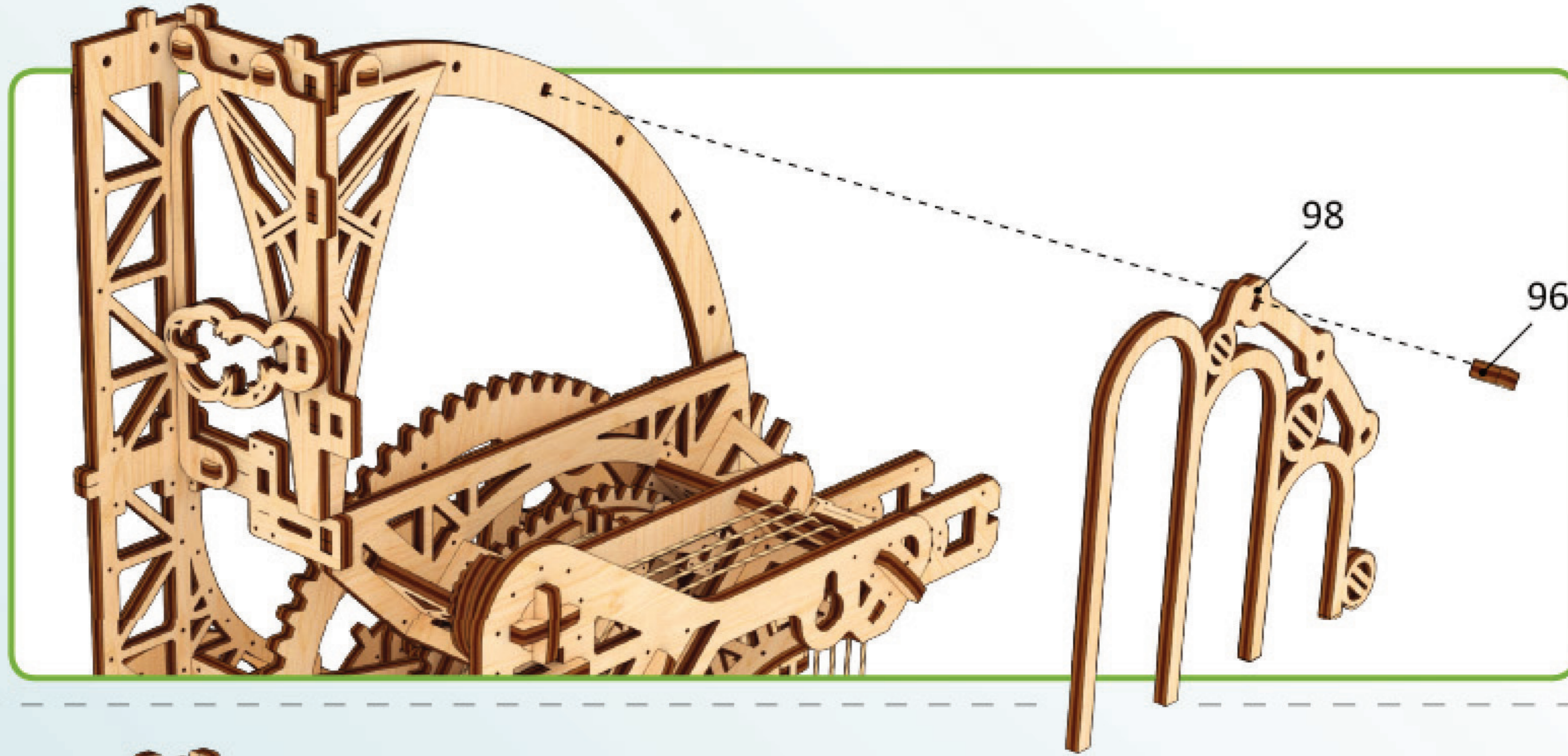

8

9

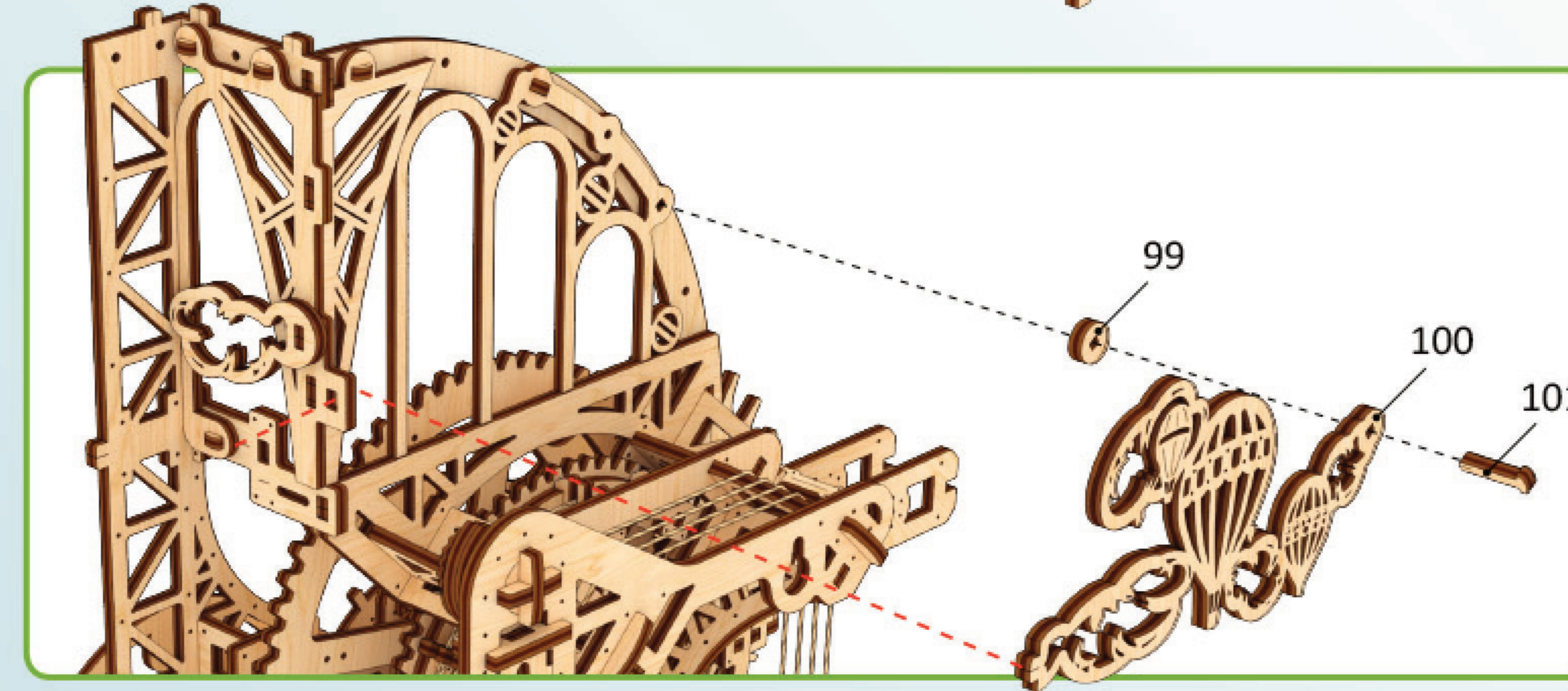

E

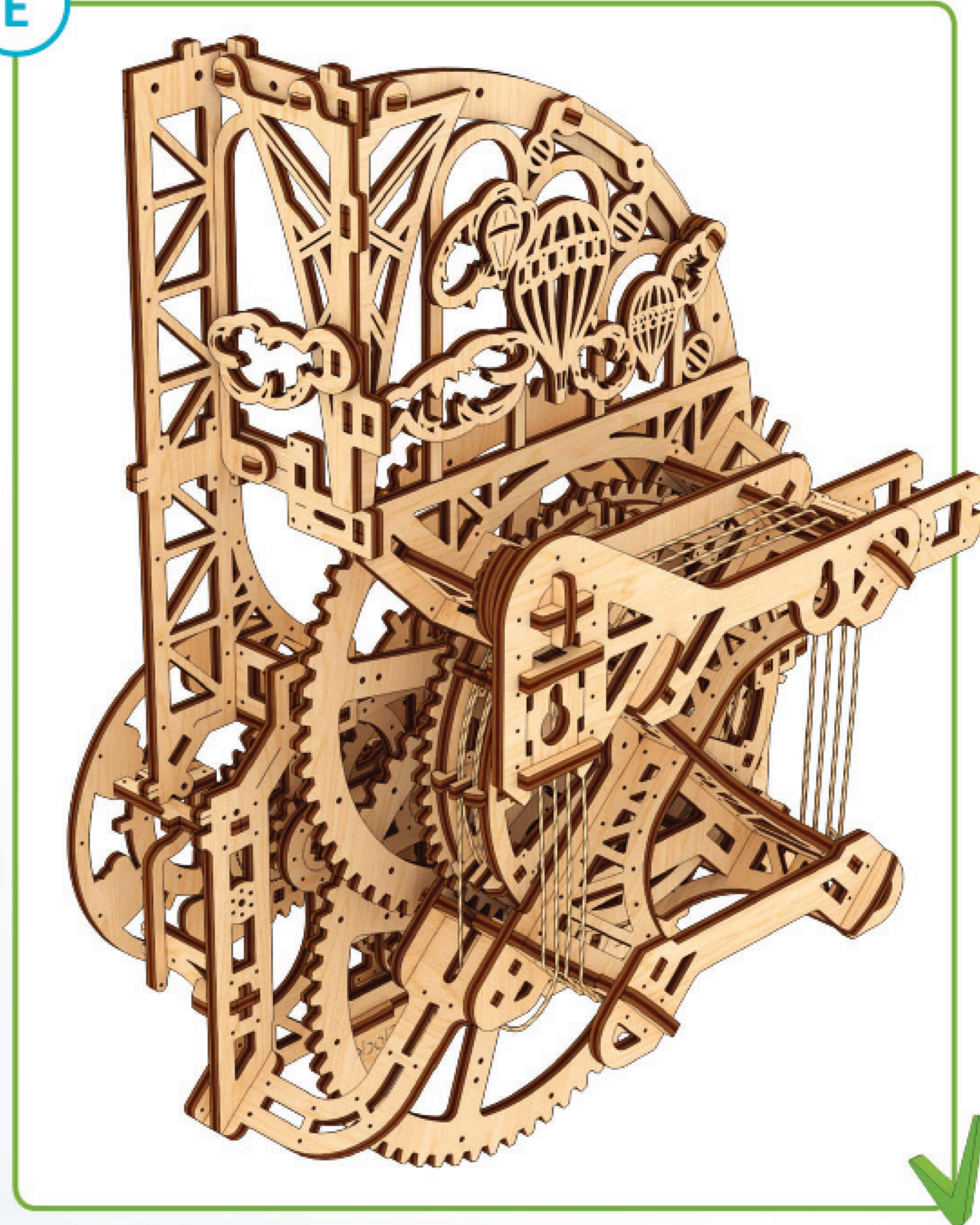



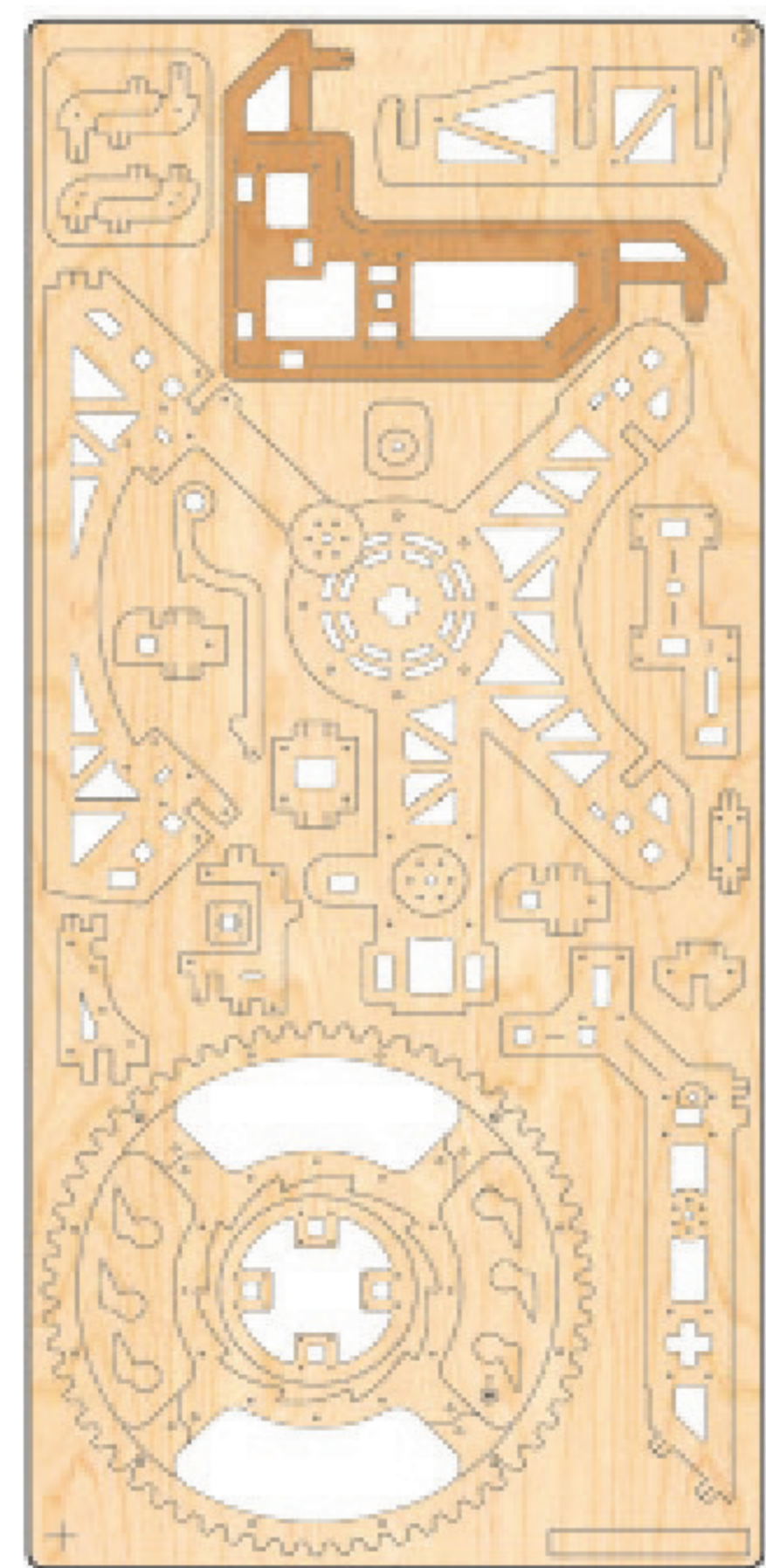

3

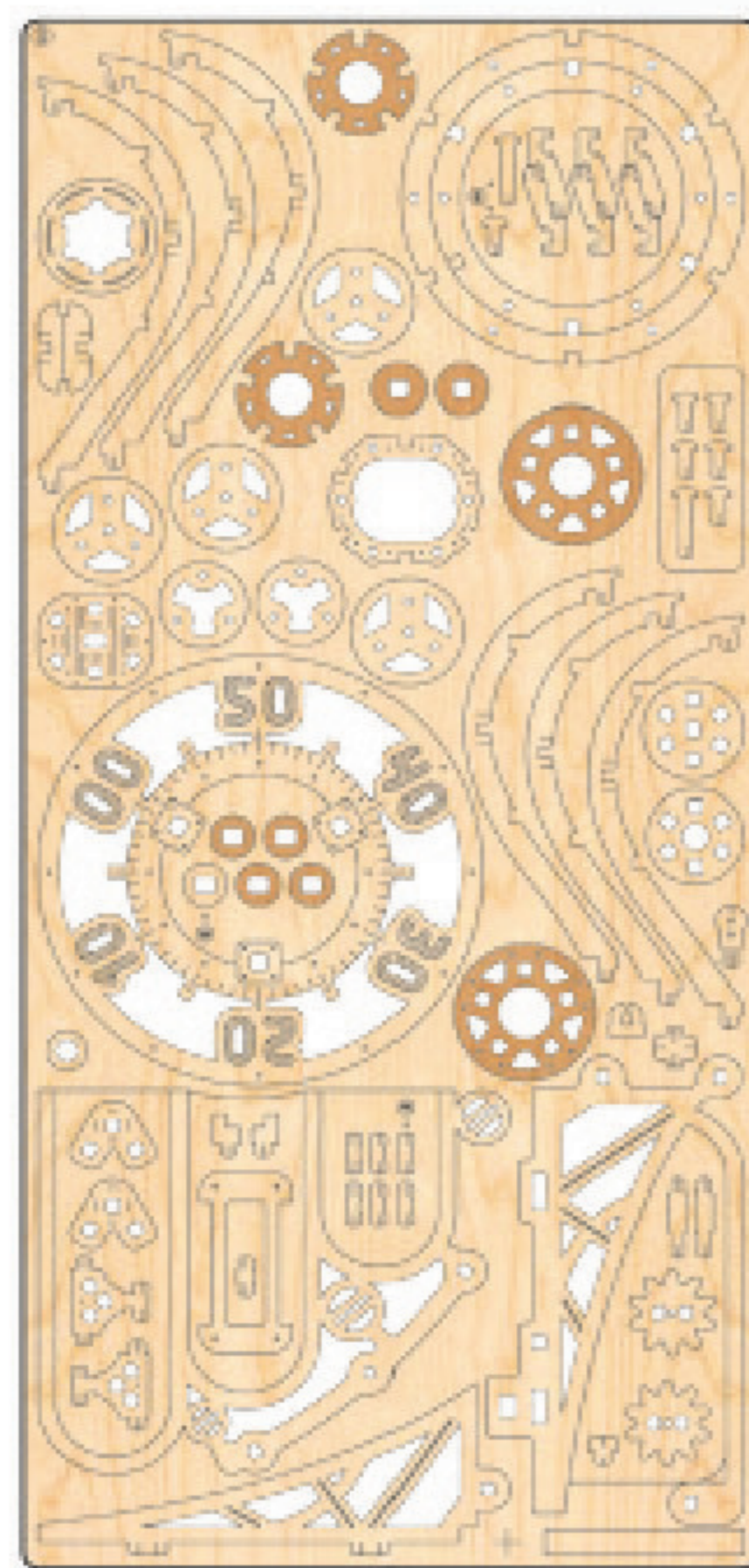

8

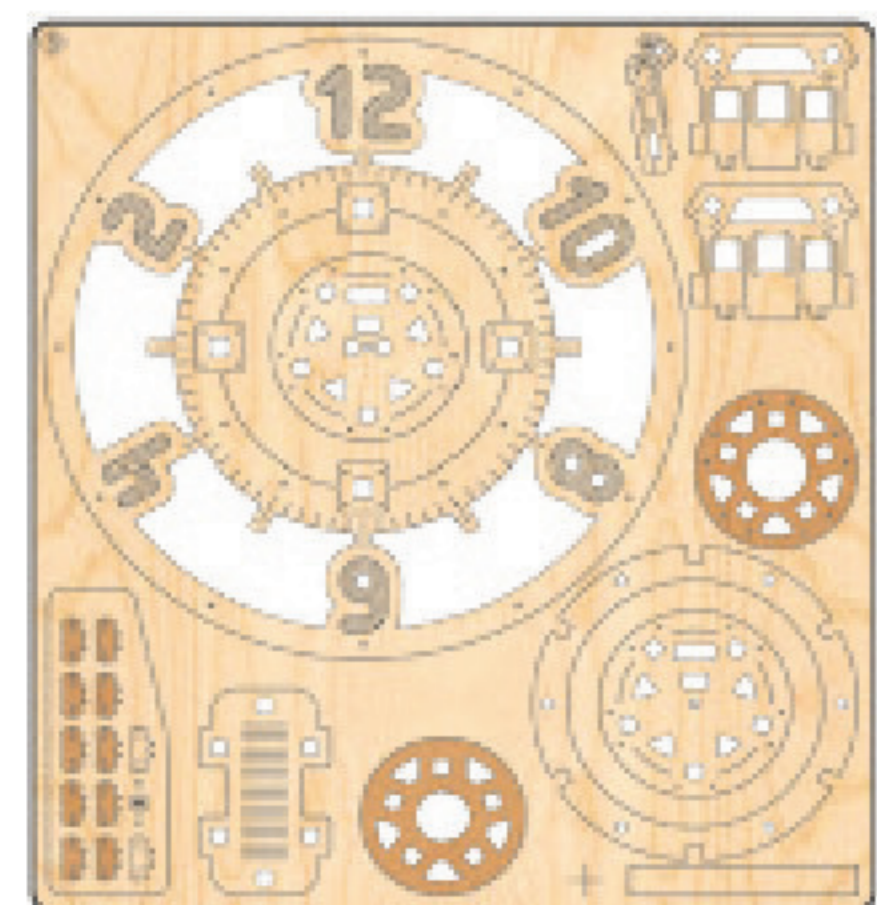

9

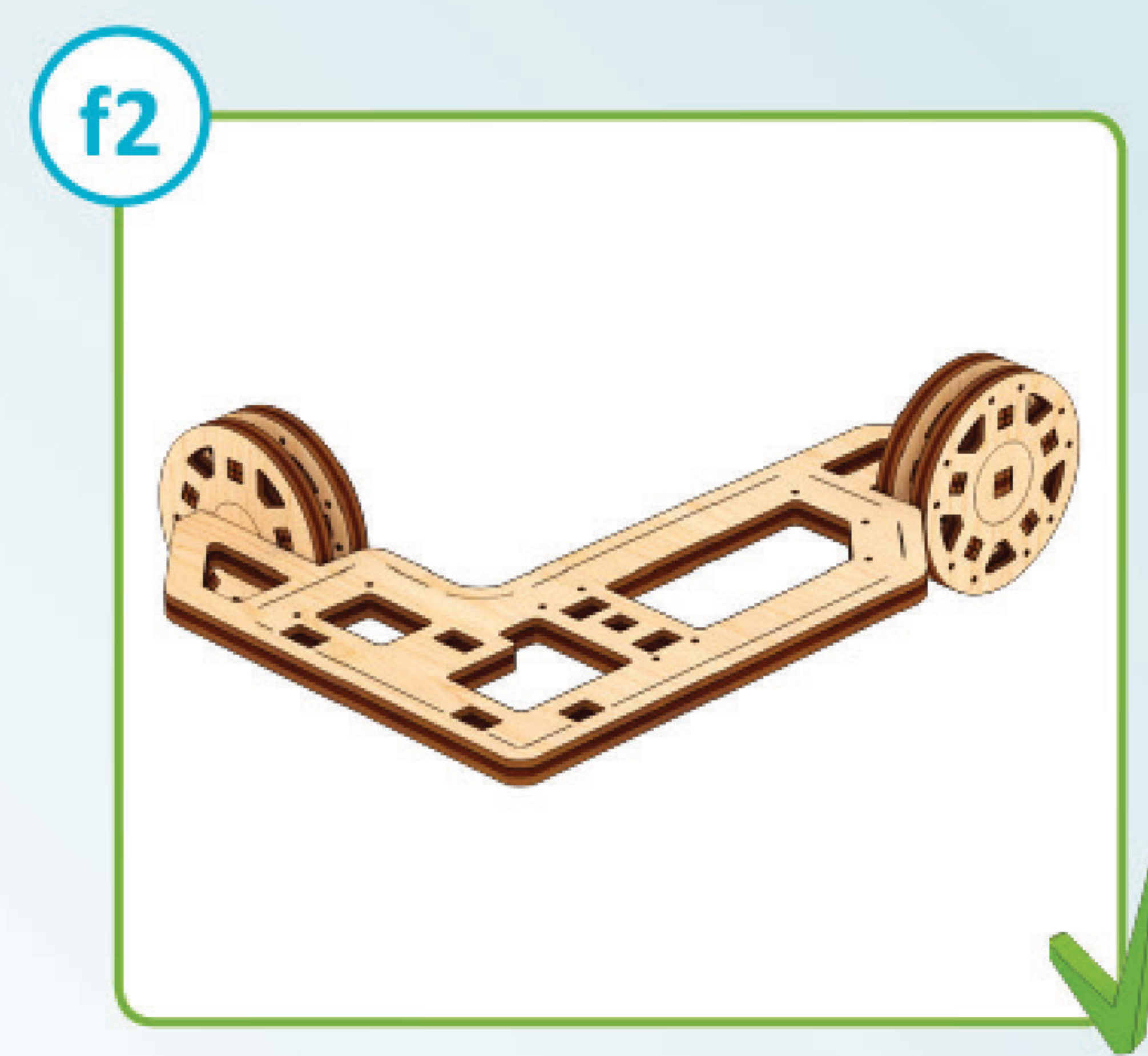
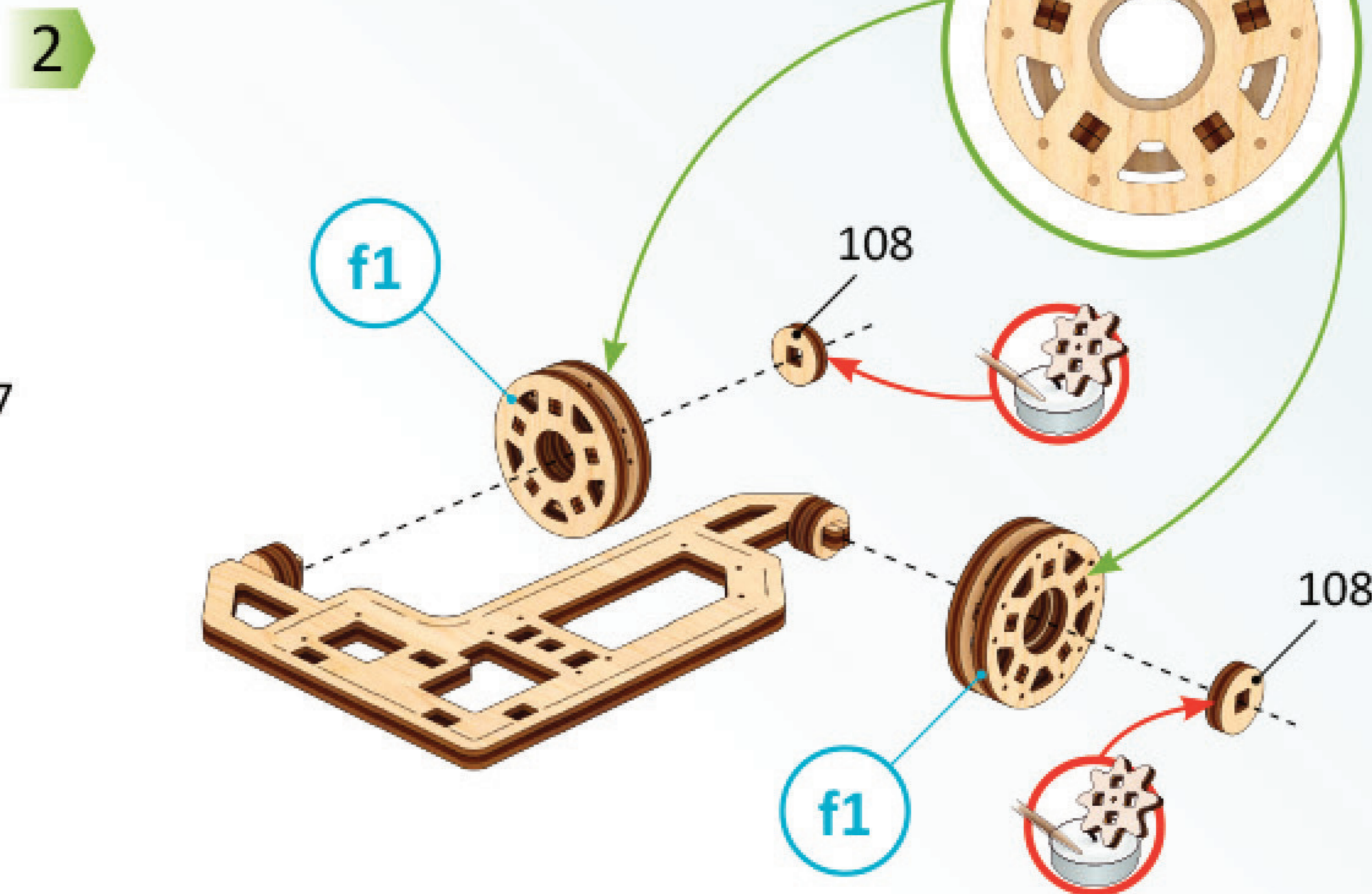
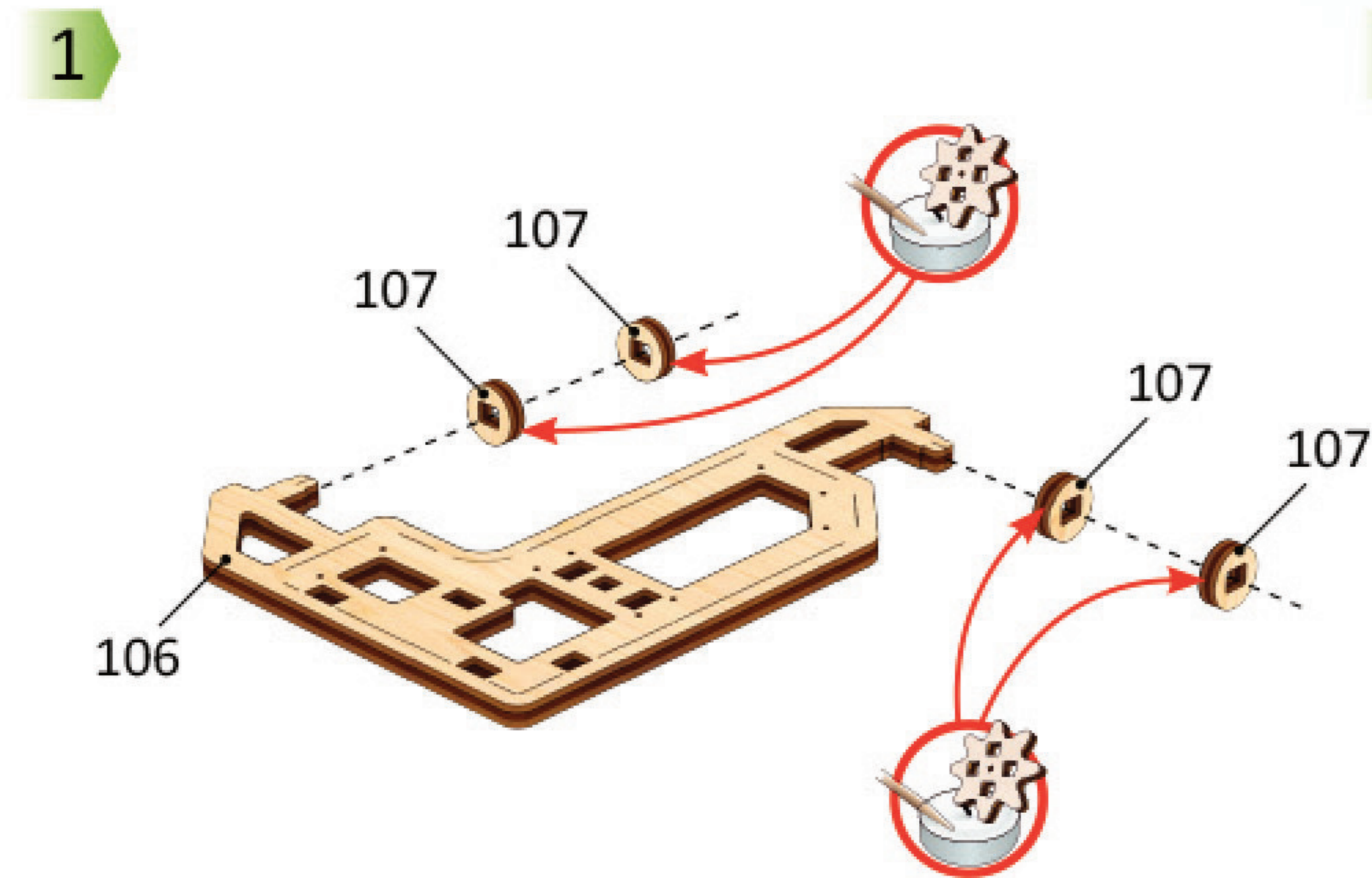
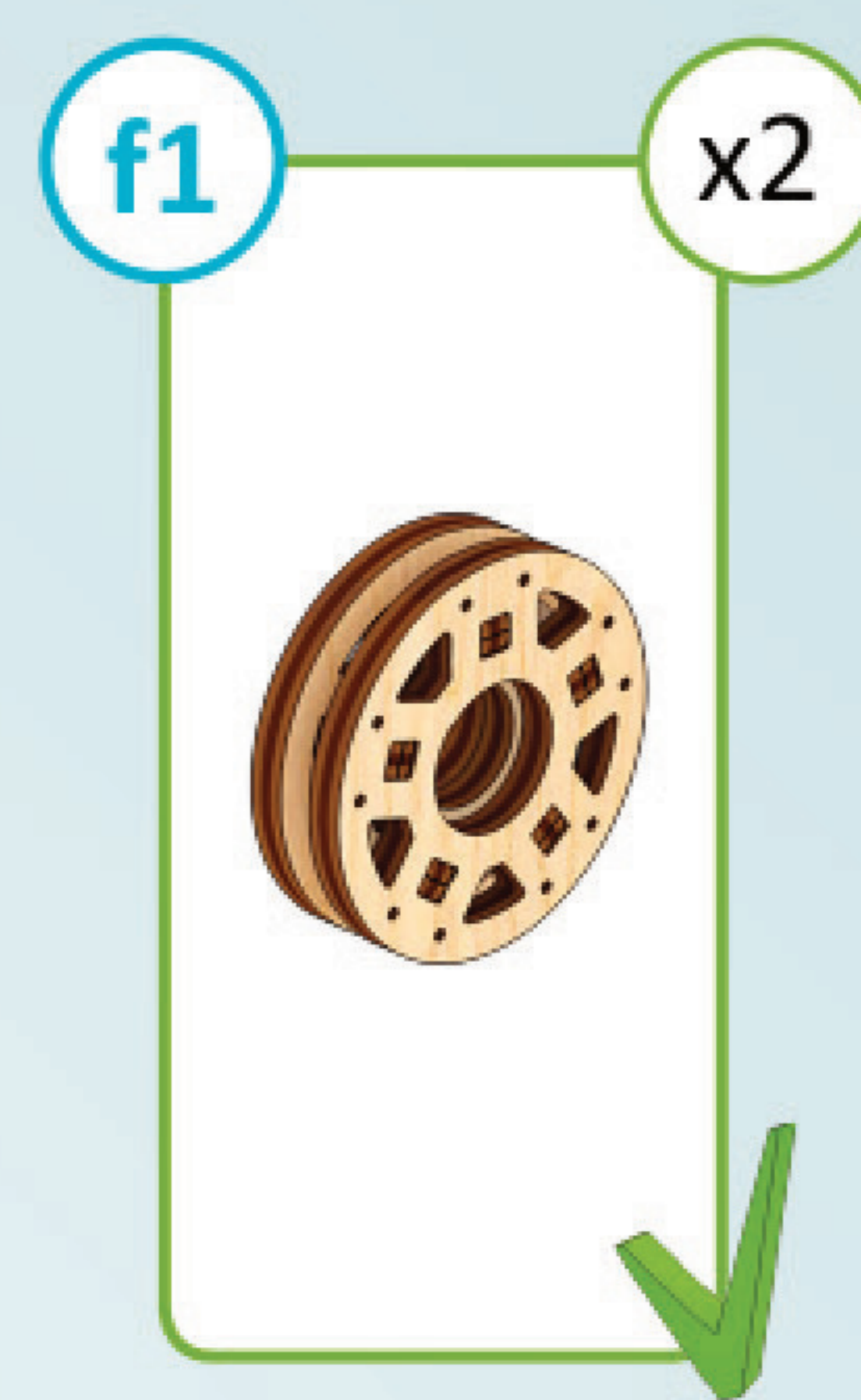
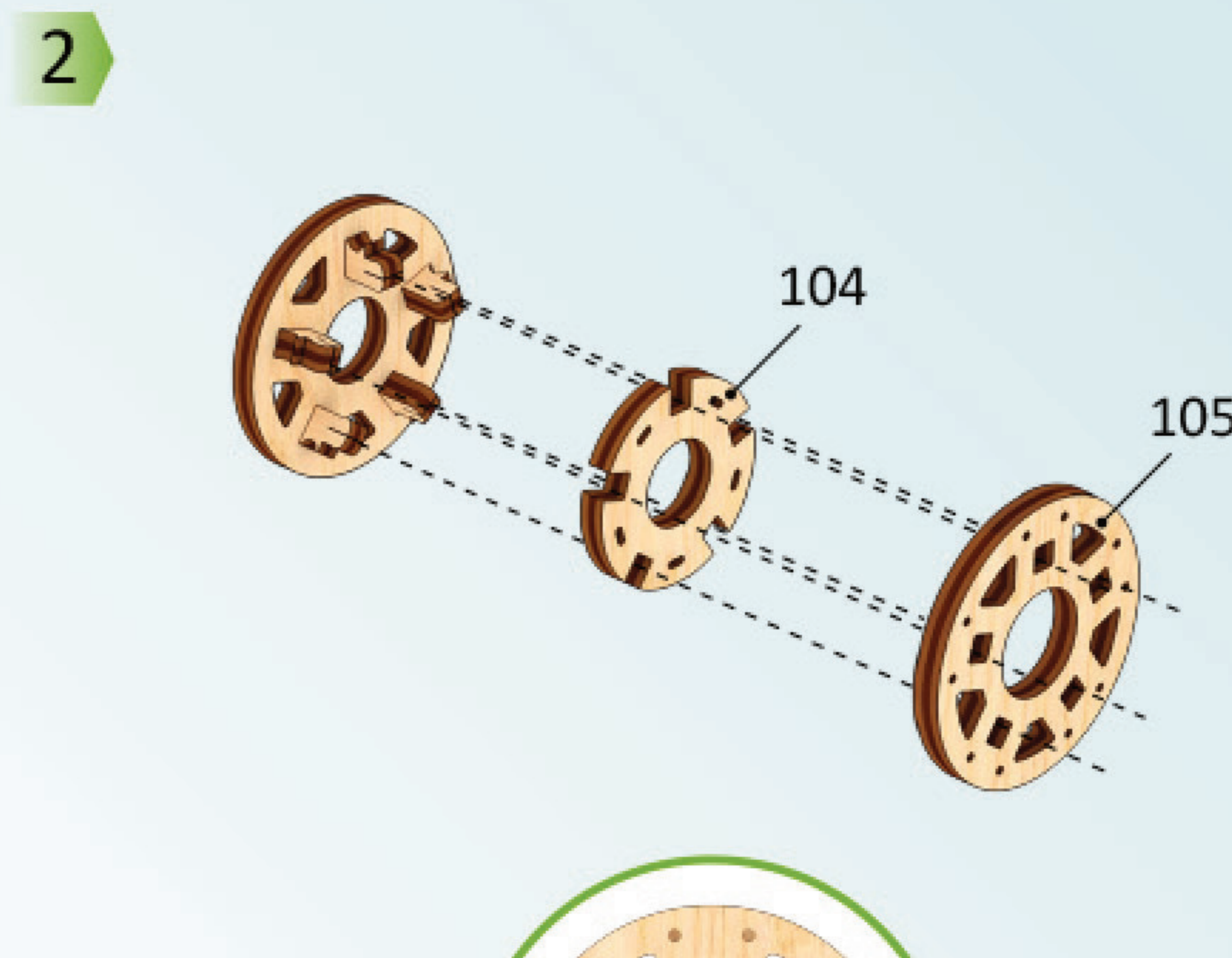
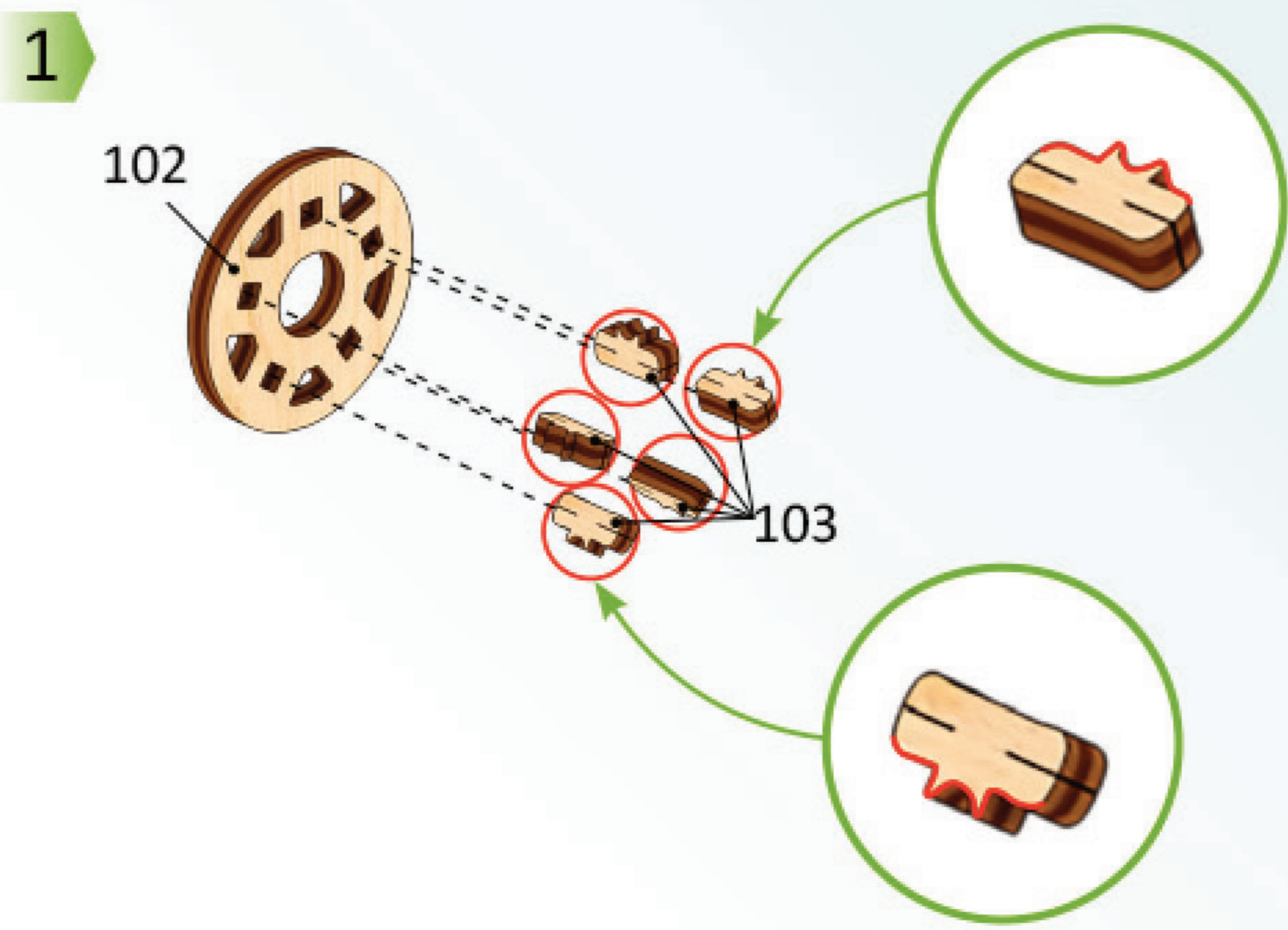

Mechanical models

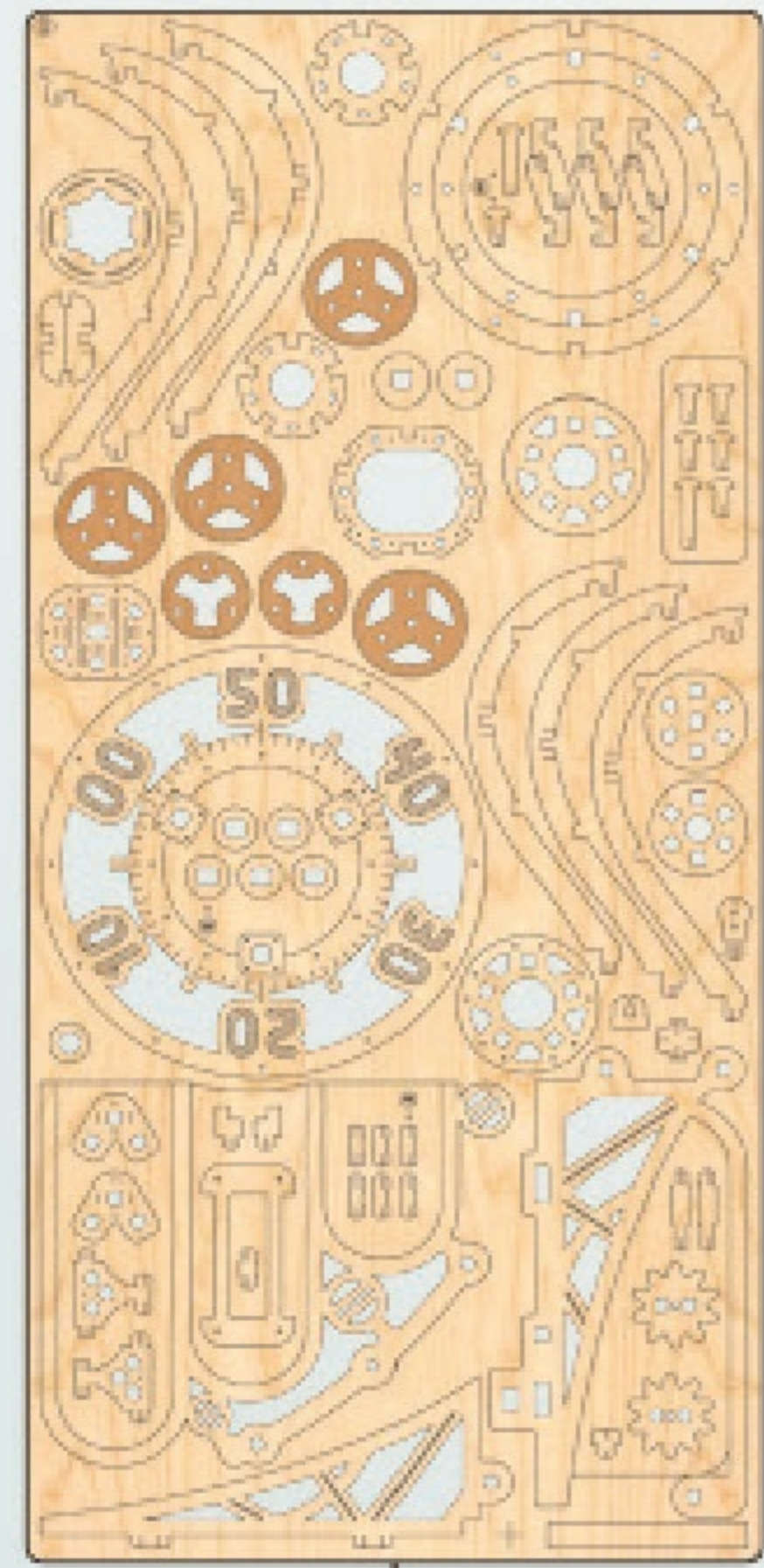

8

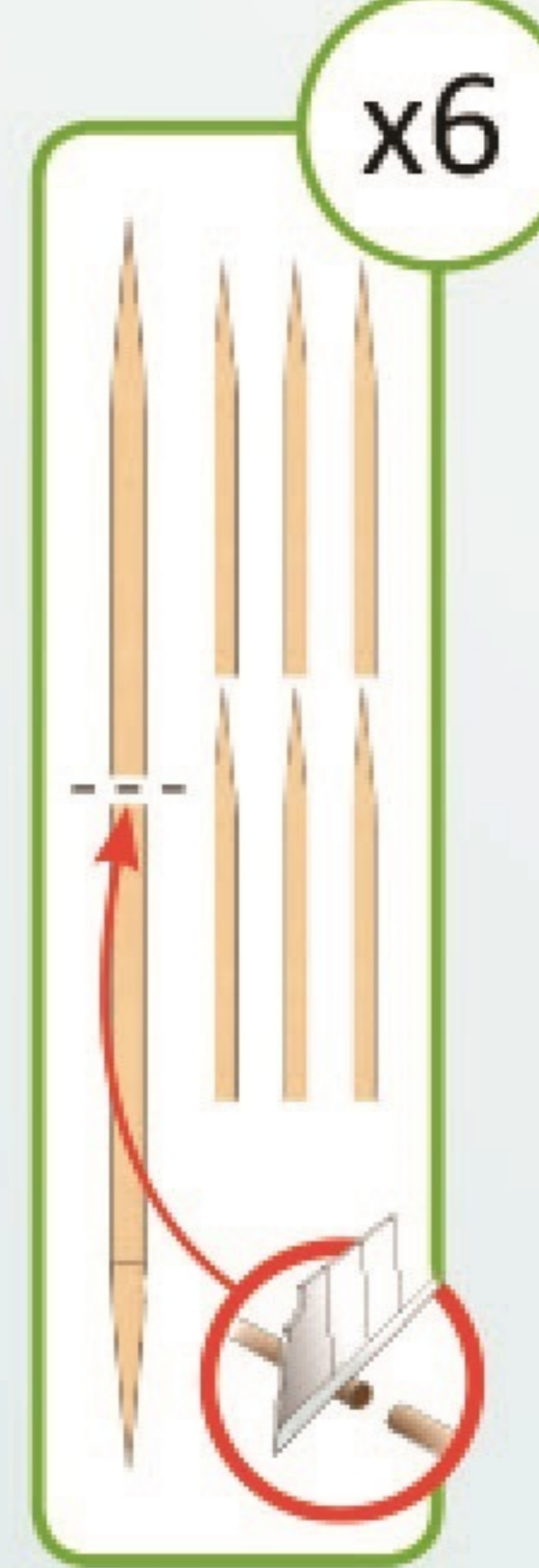

x6

1

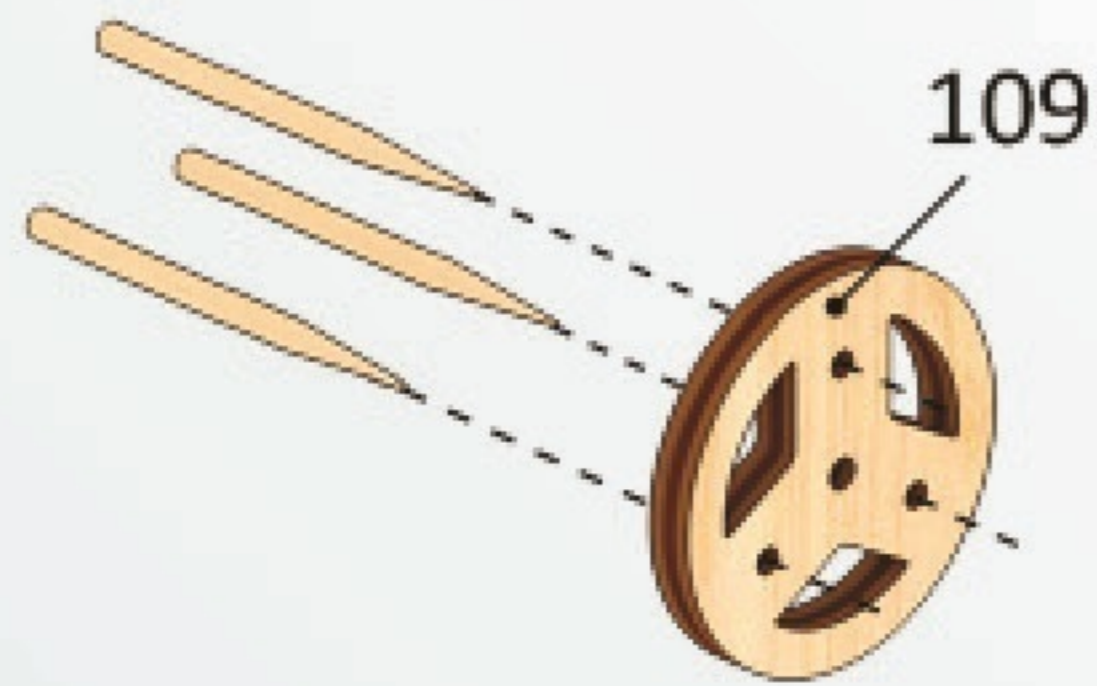

109

2

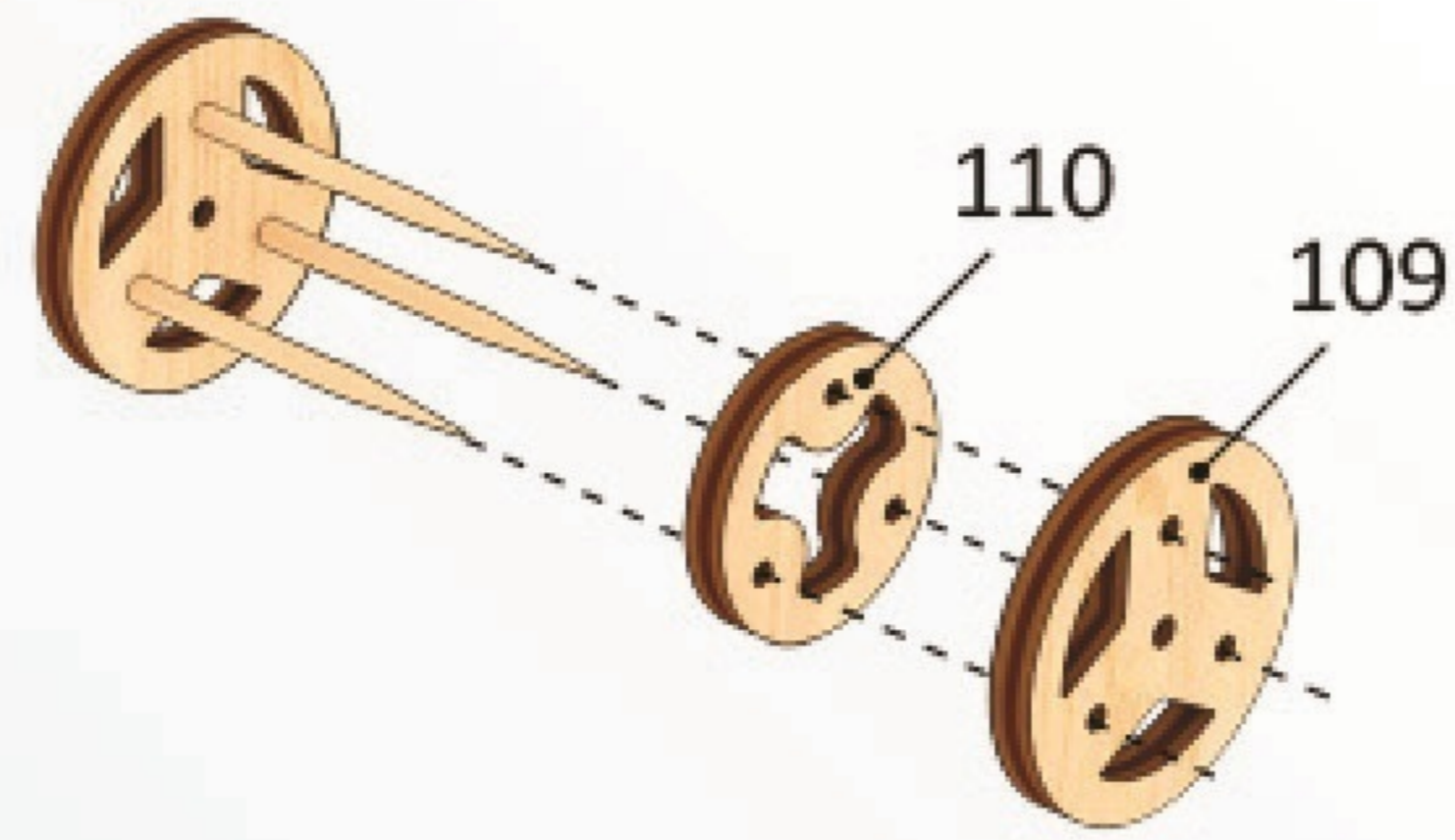

110

109

3

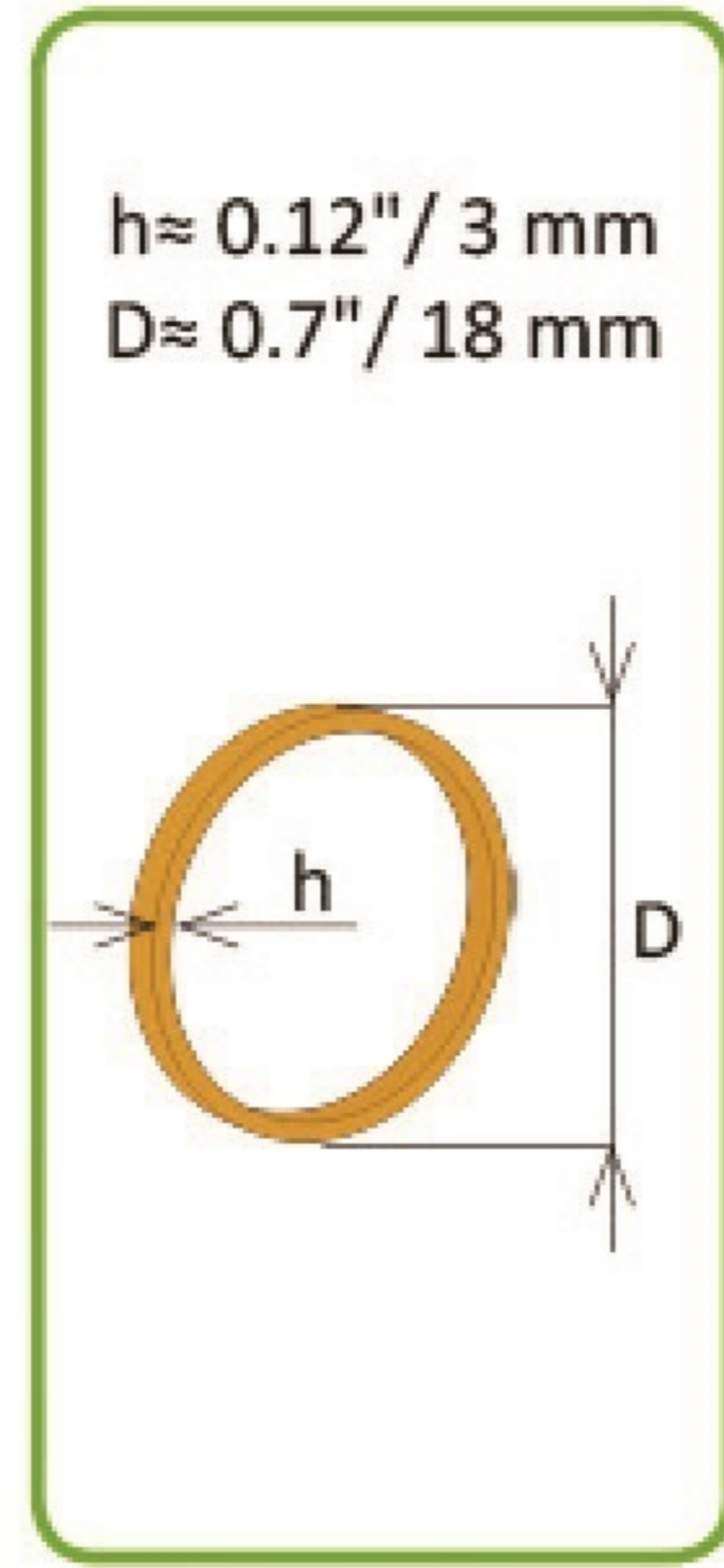
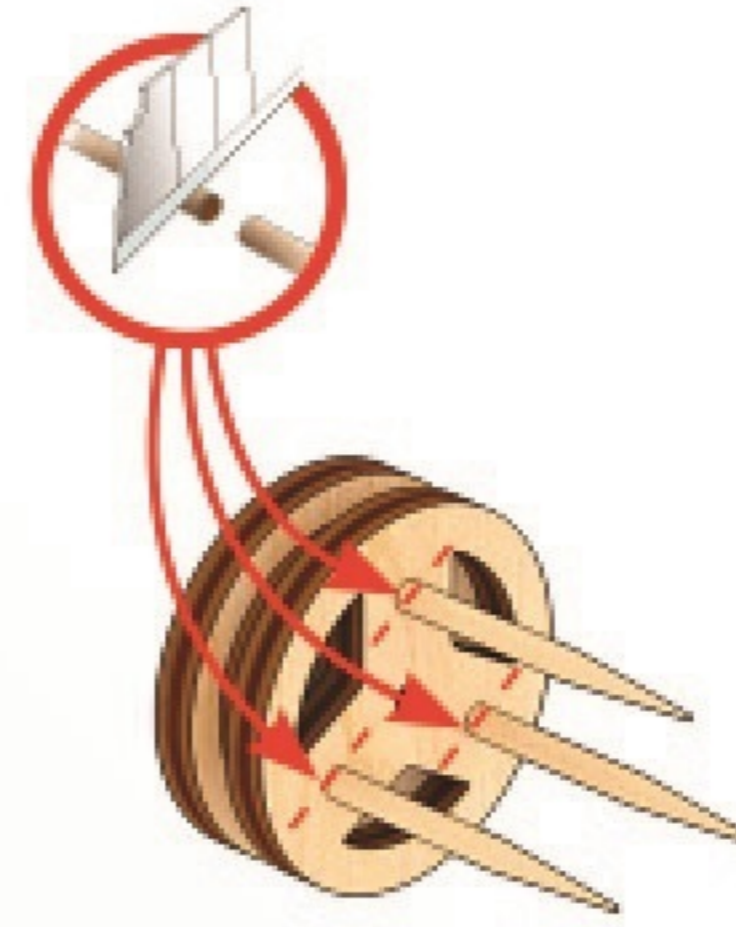

4

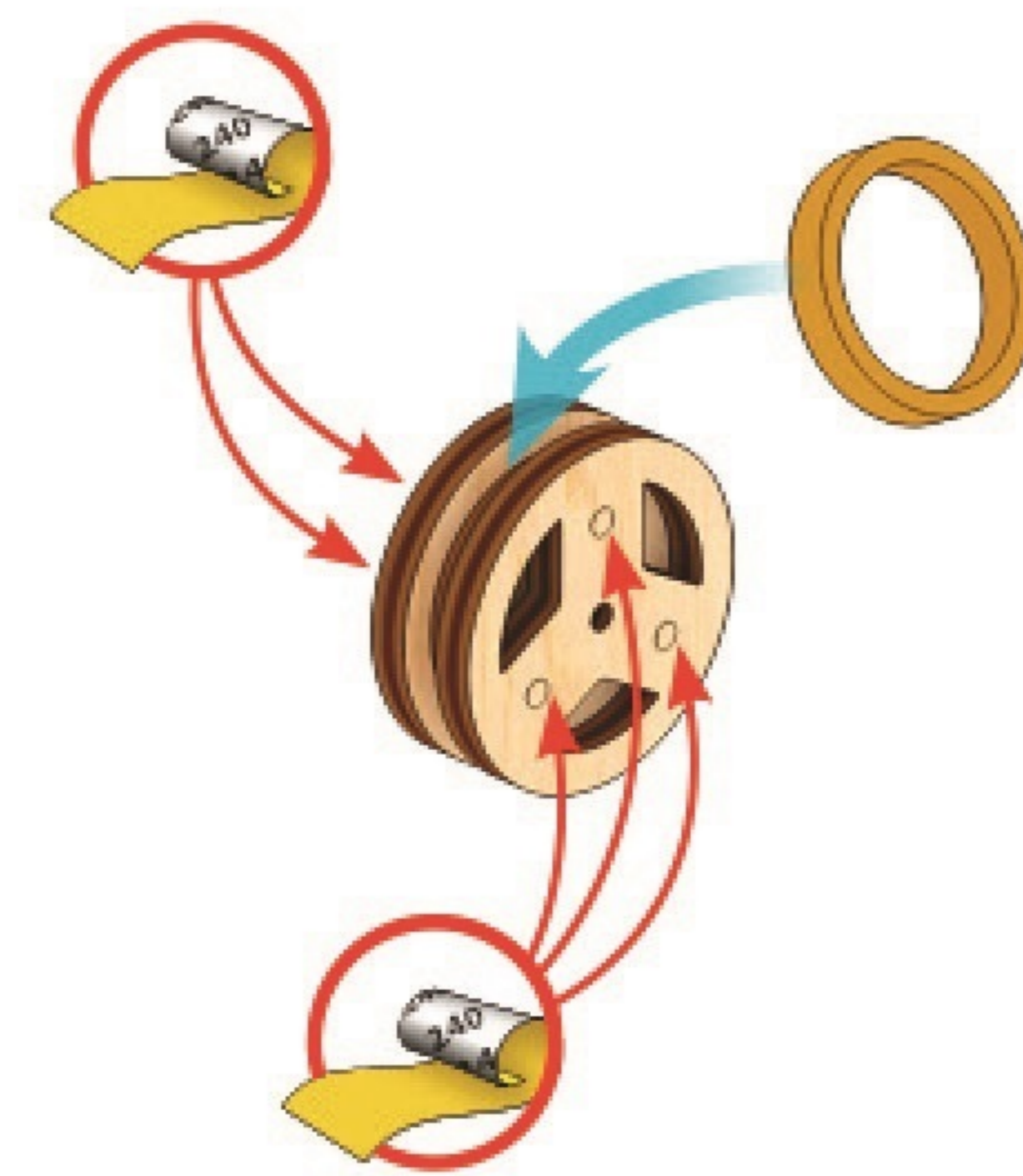

f3

x2

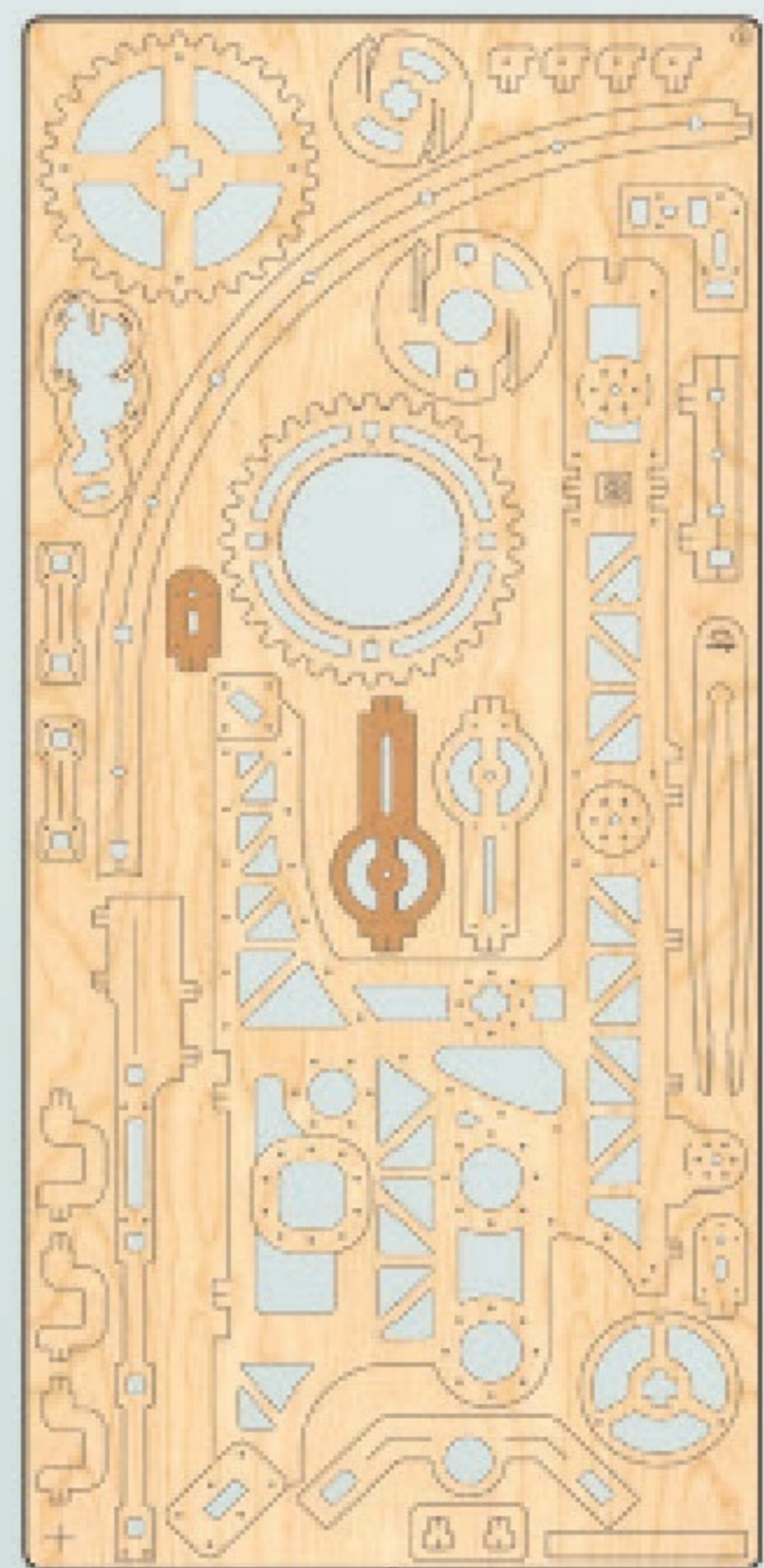

4

1

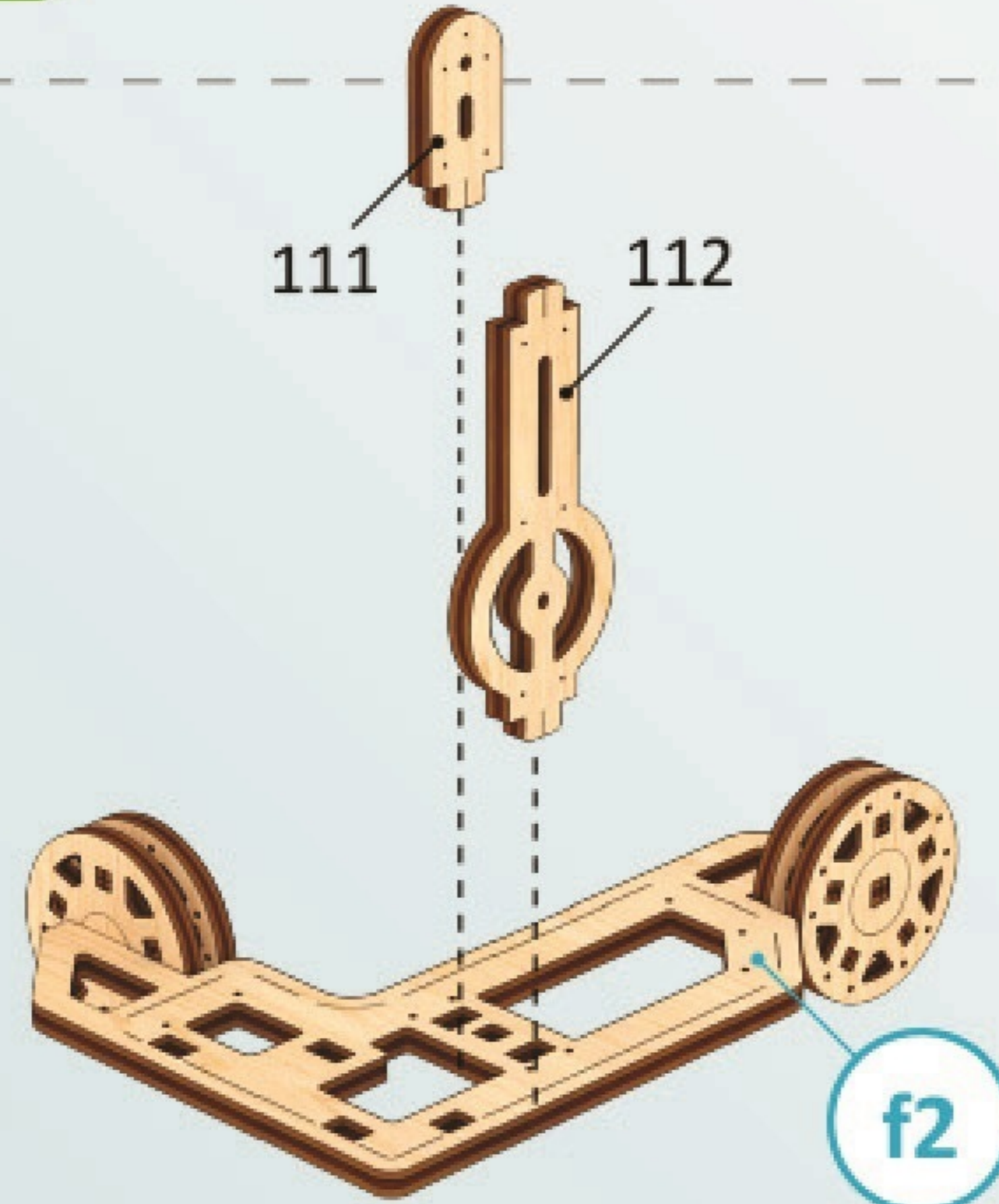

111

112

f2

2

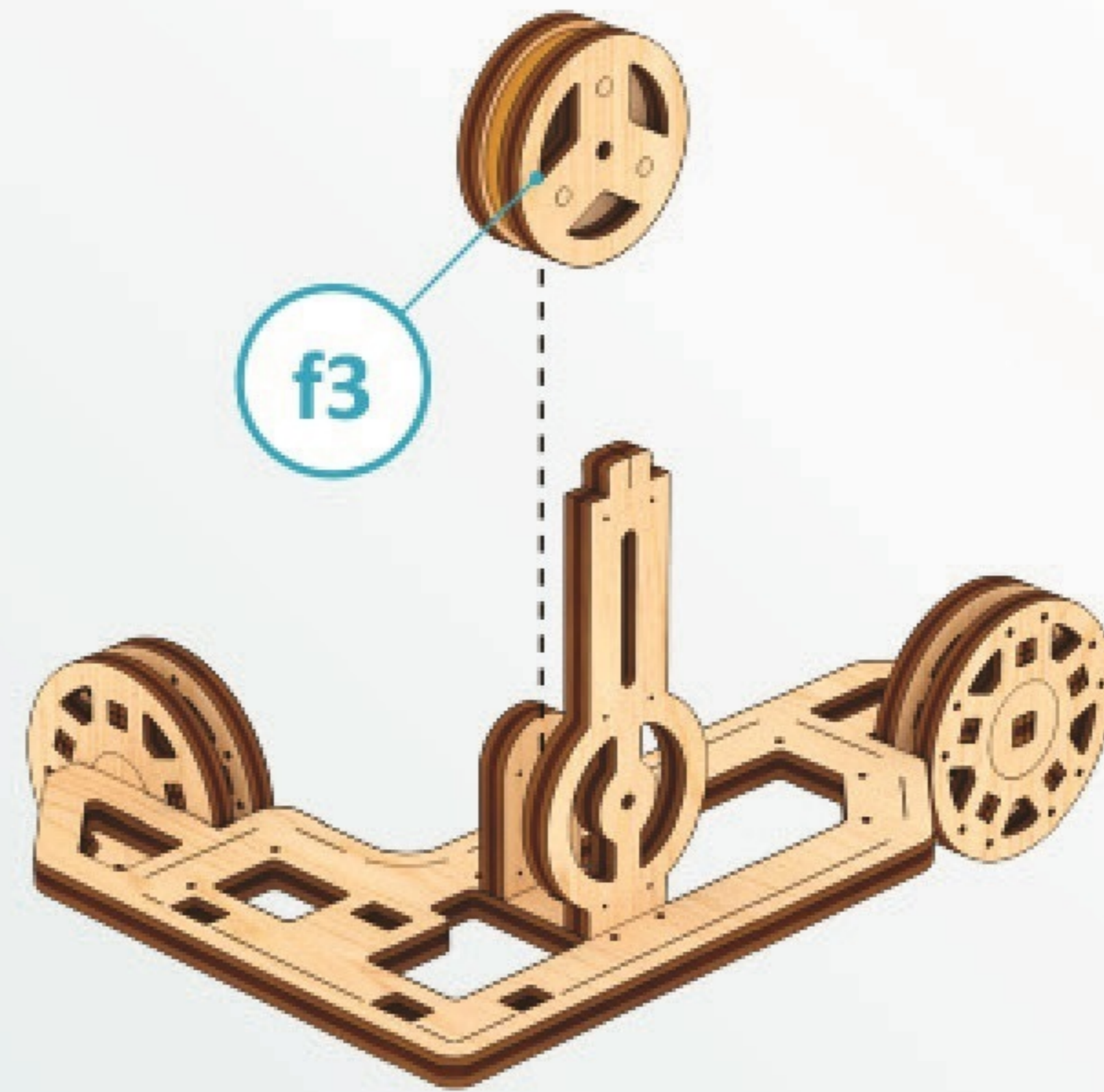

f3

3

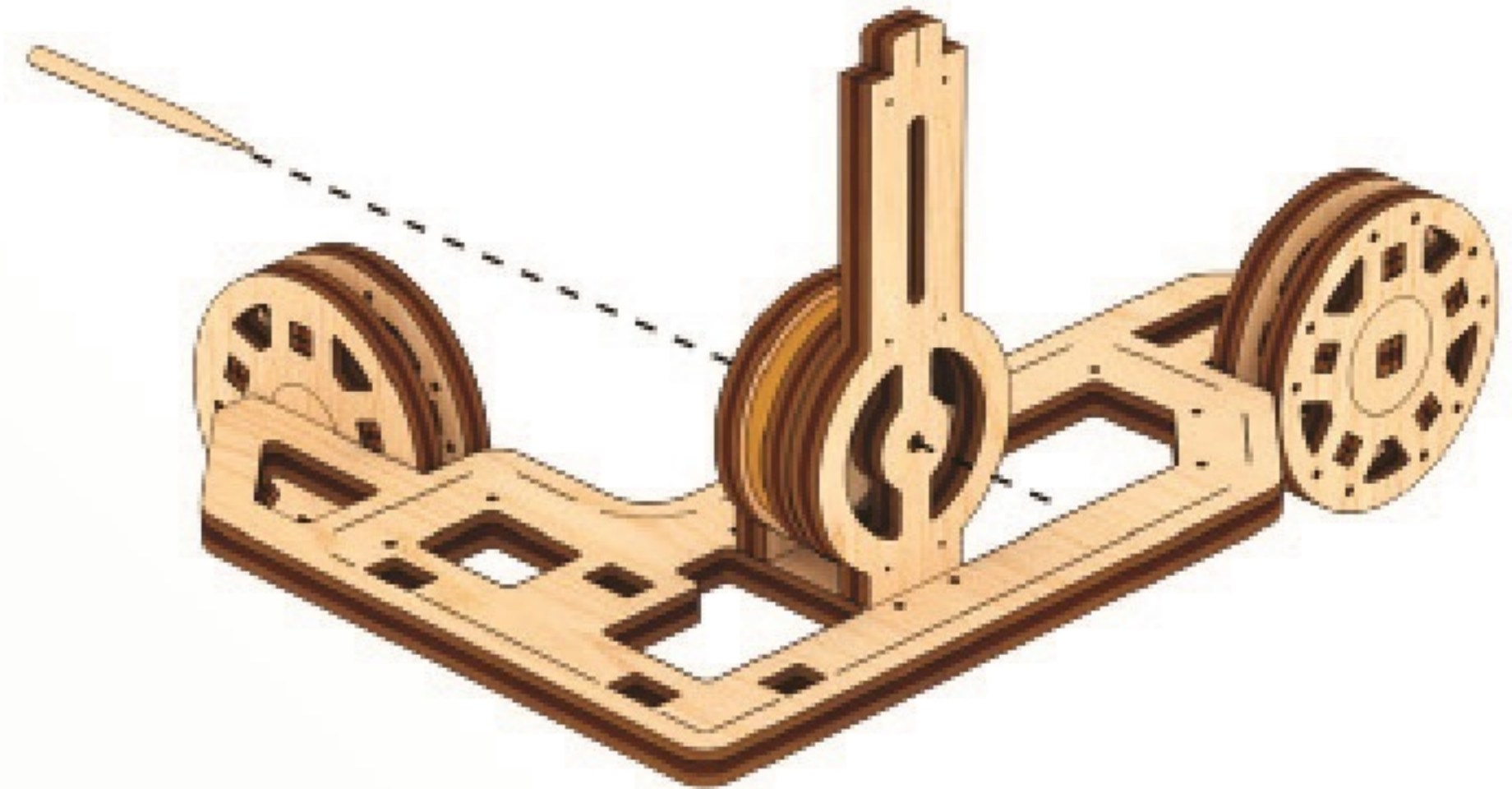
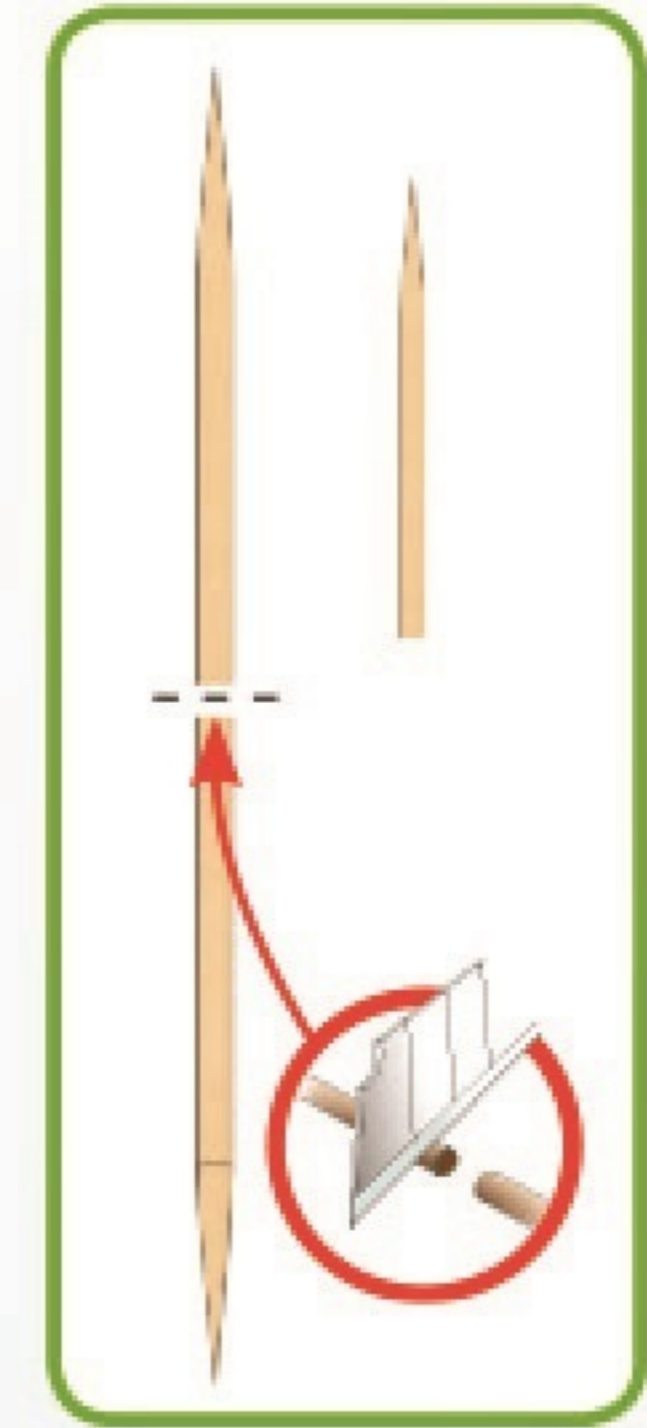

Controleer het mechanisme op een soepele en goede beweging. Breng het mechanisme in beweging om de onderdelen in positie te krijgen.

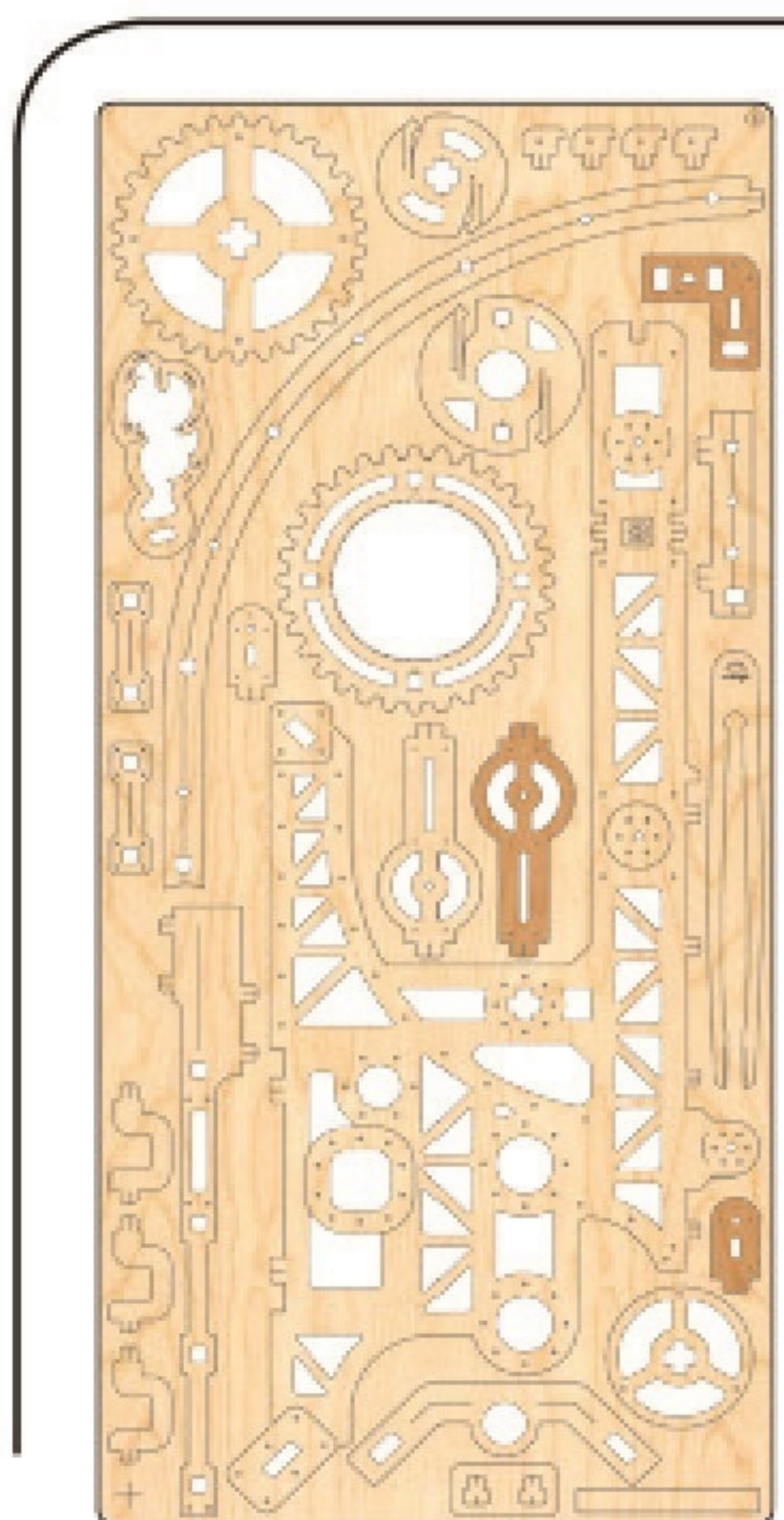

4

4

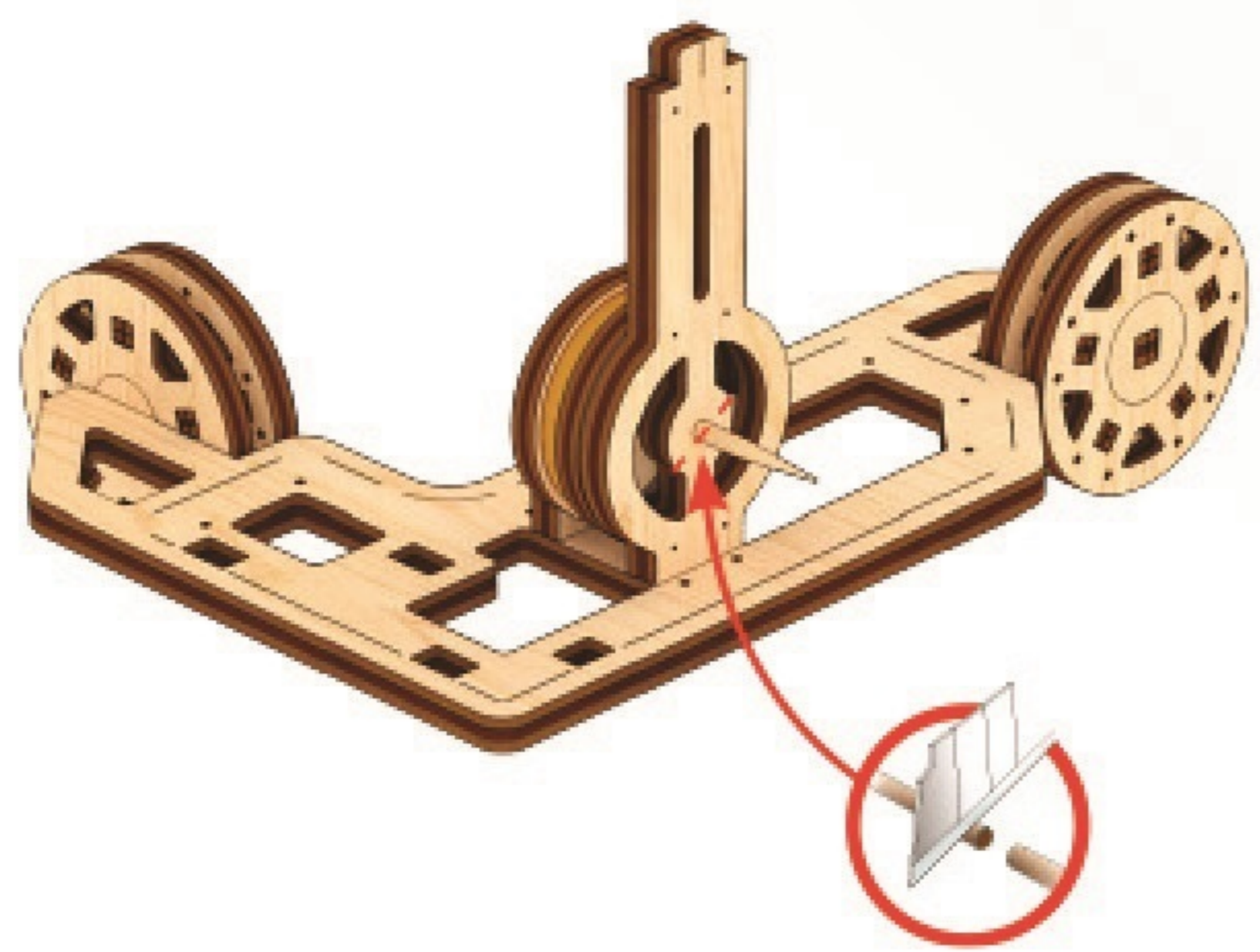

5

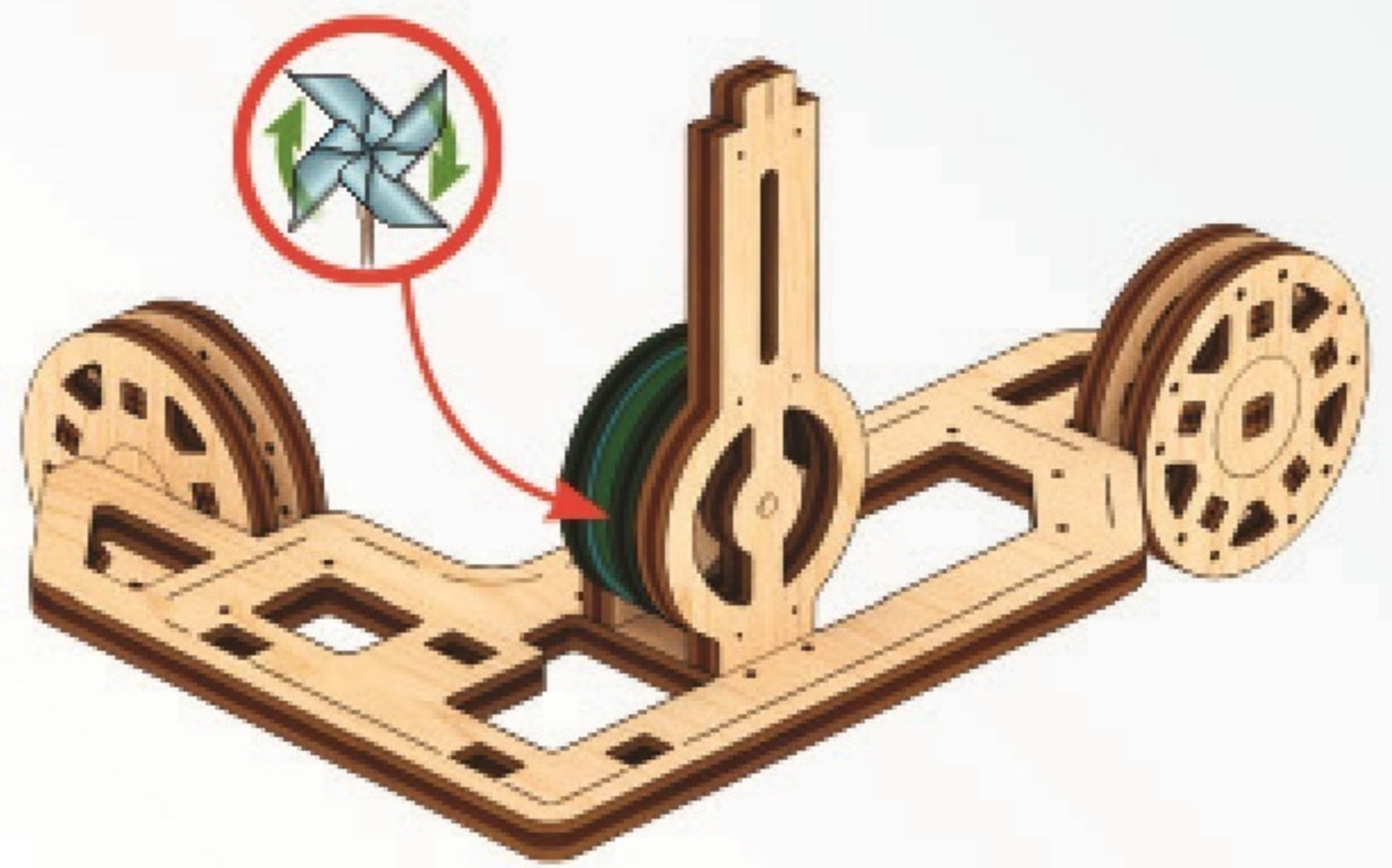

6

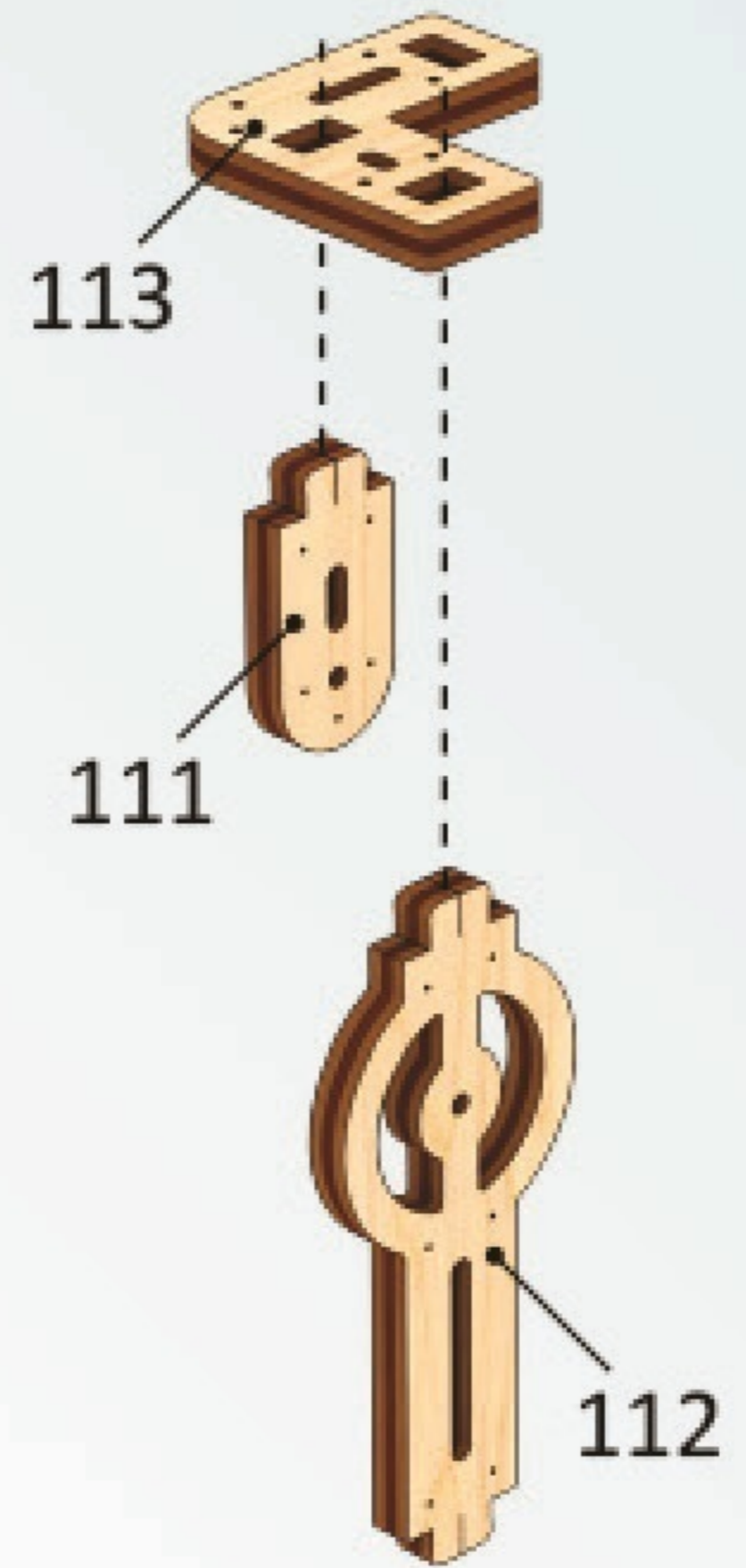

7



8

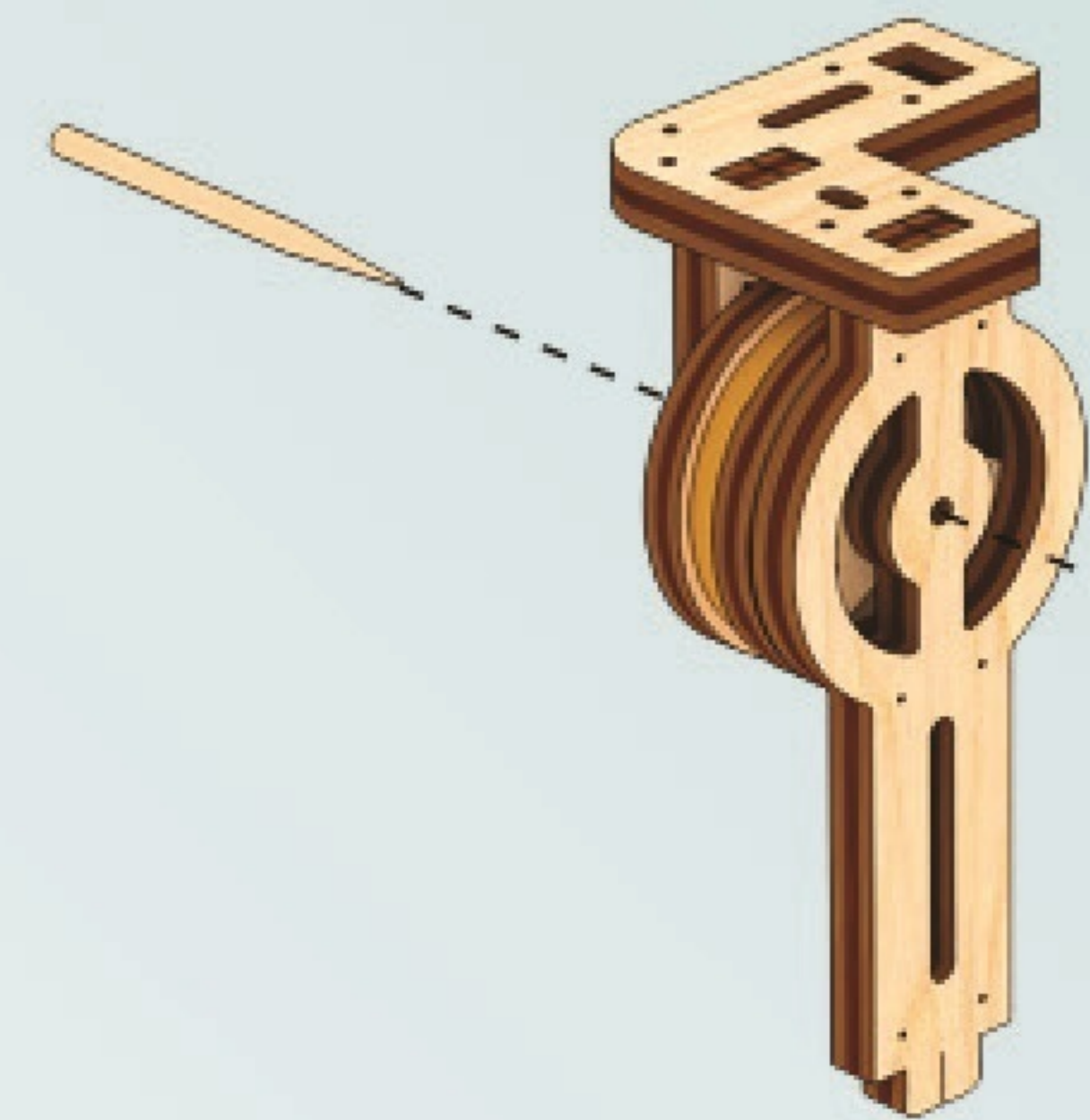
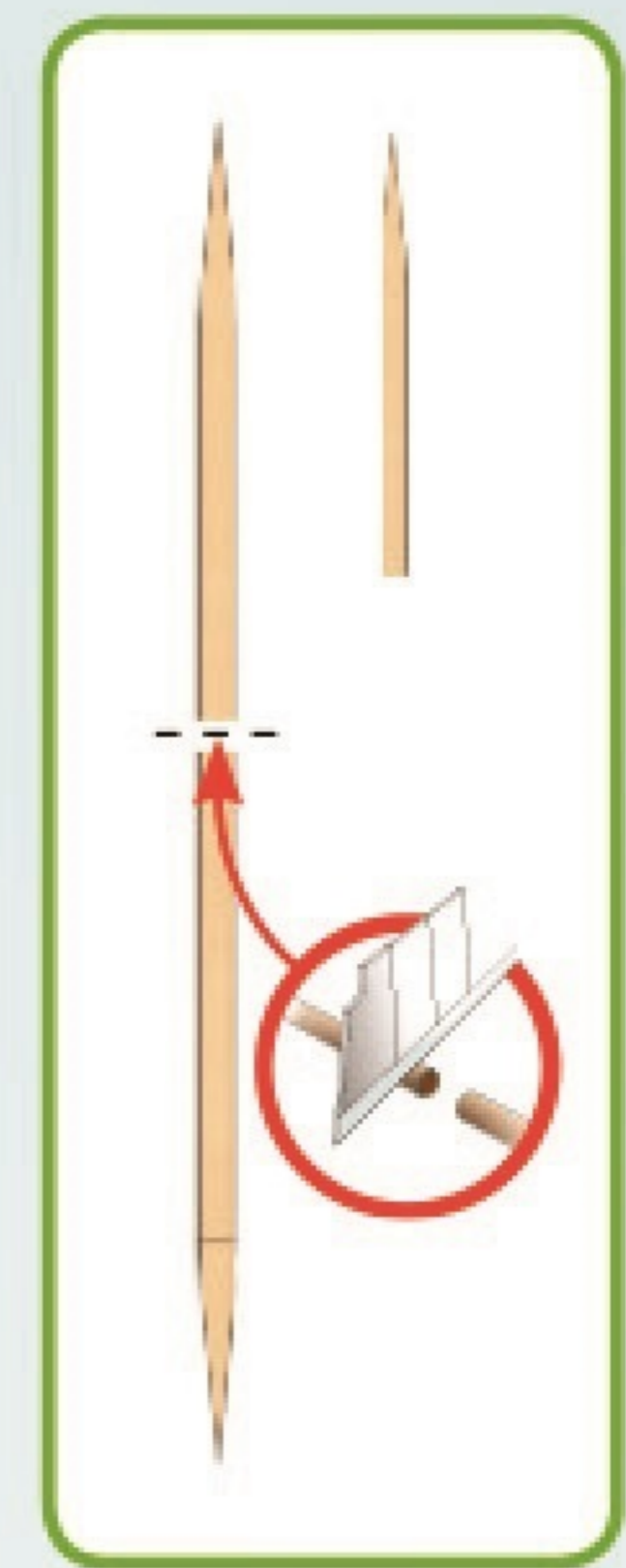

9

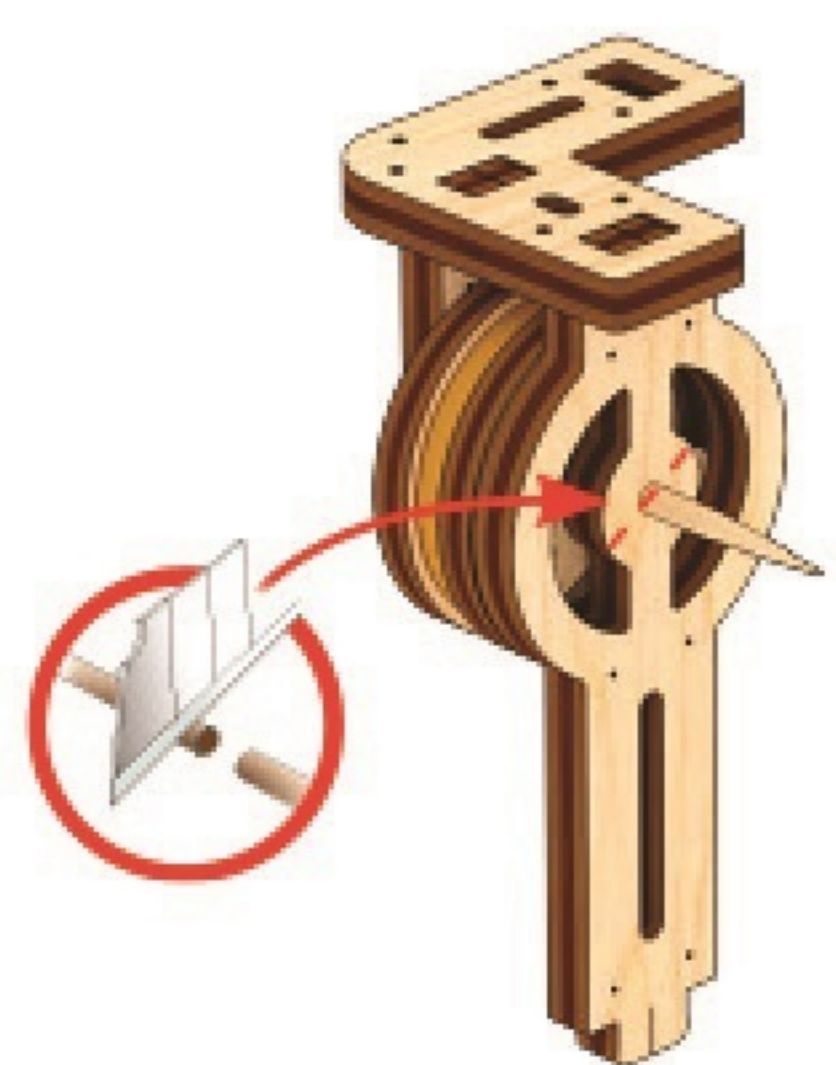

10

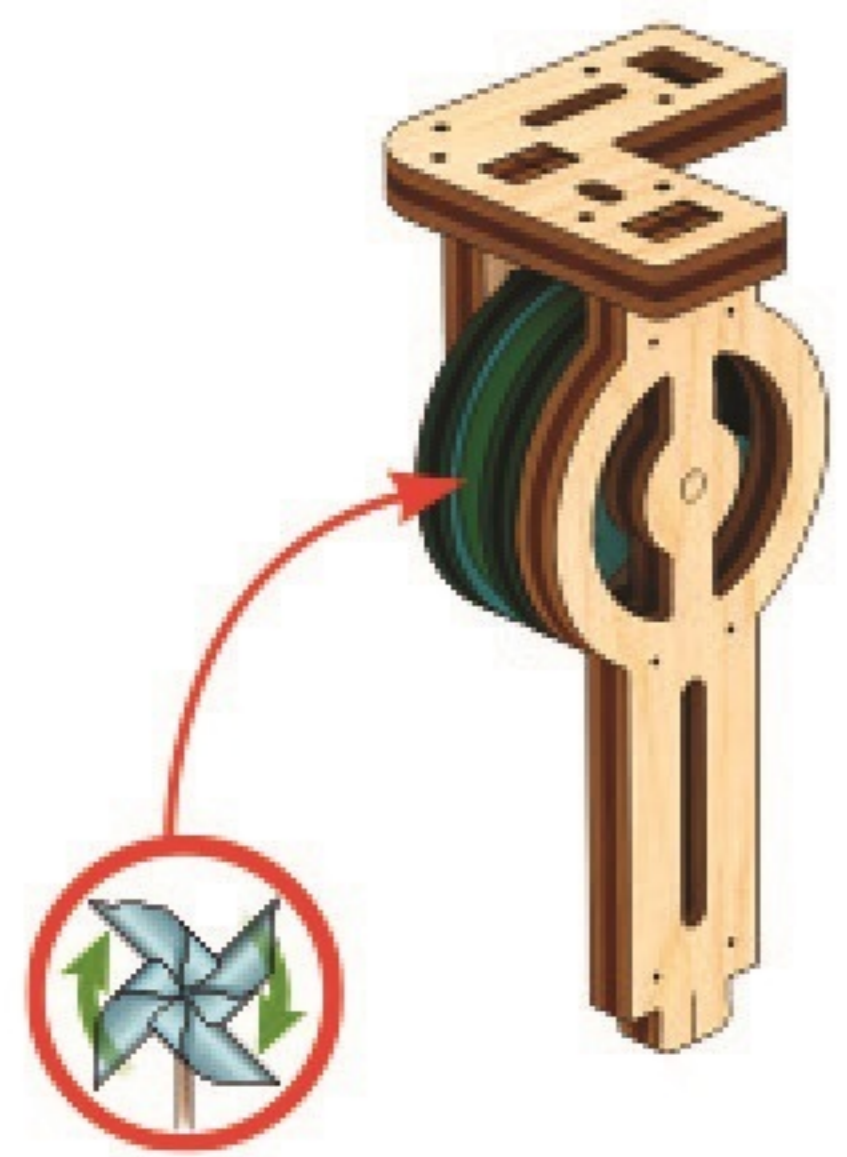

11

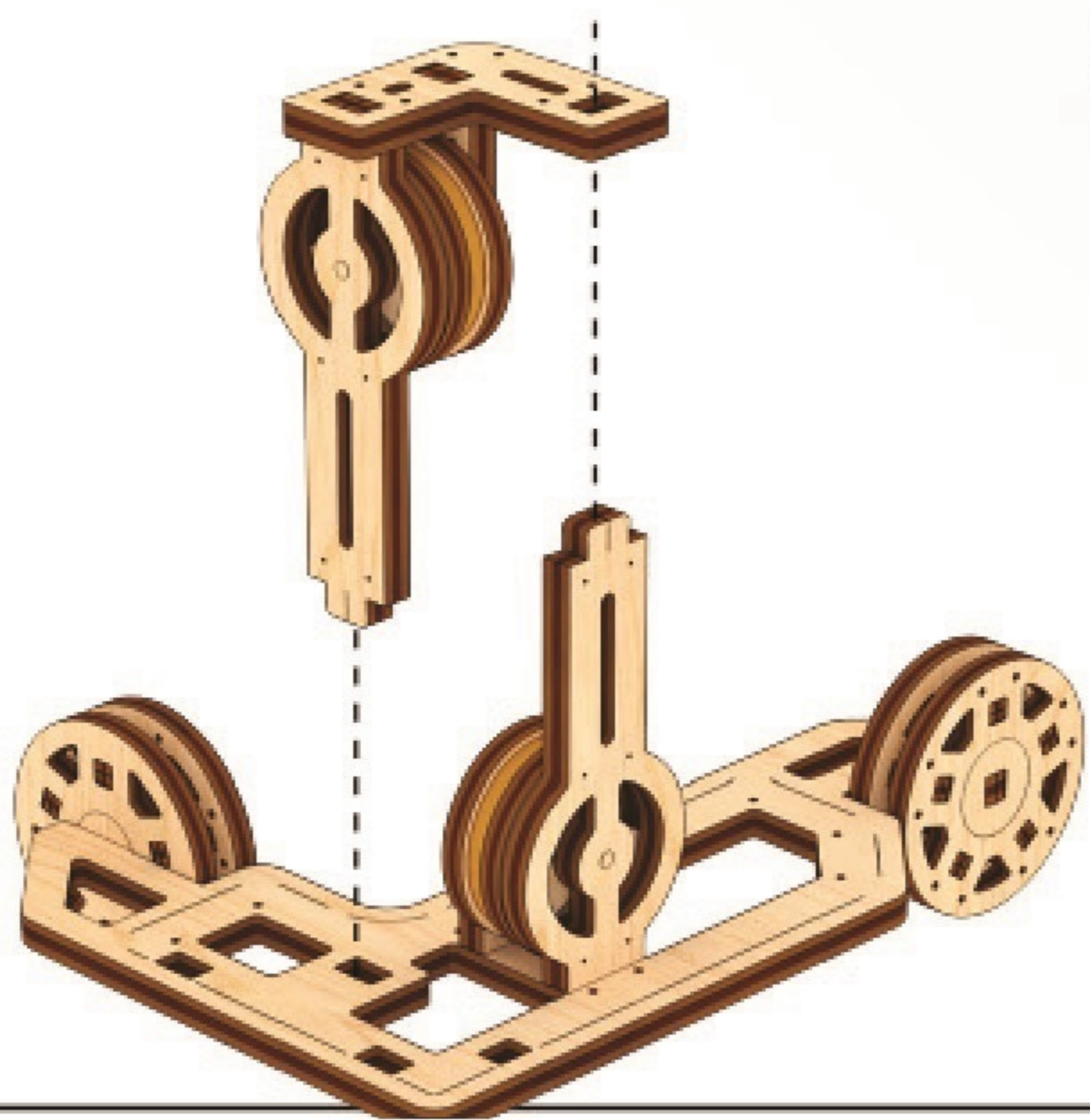

12

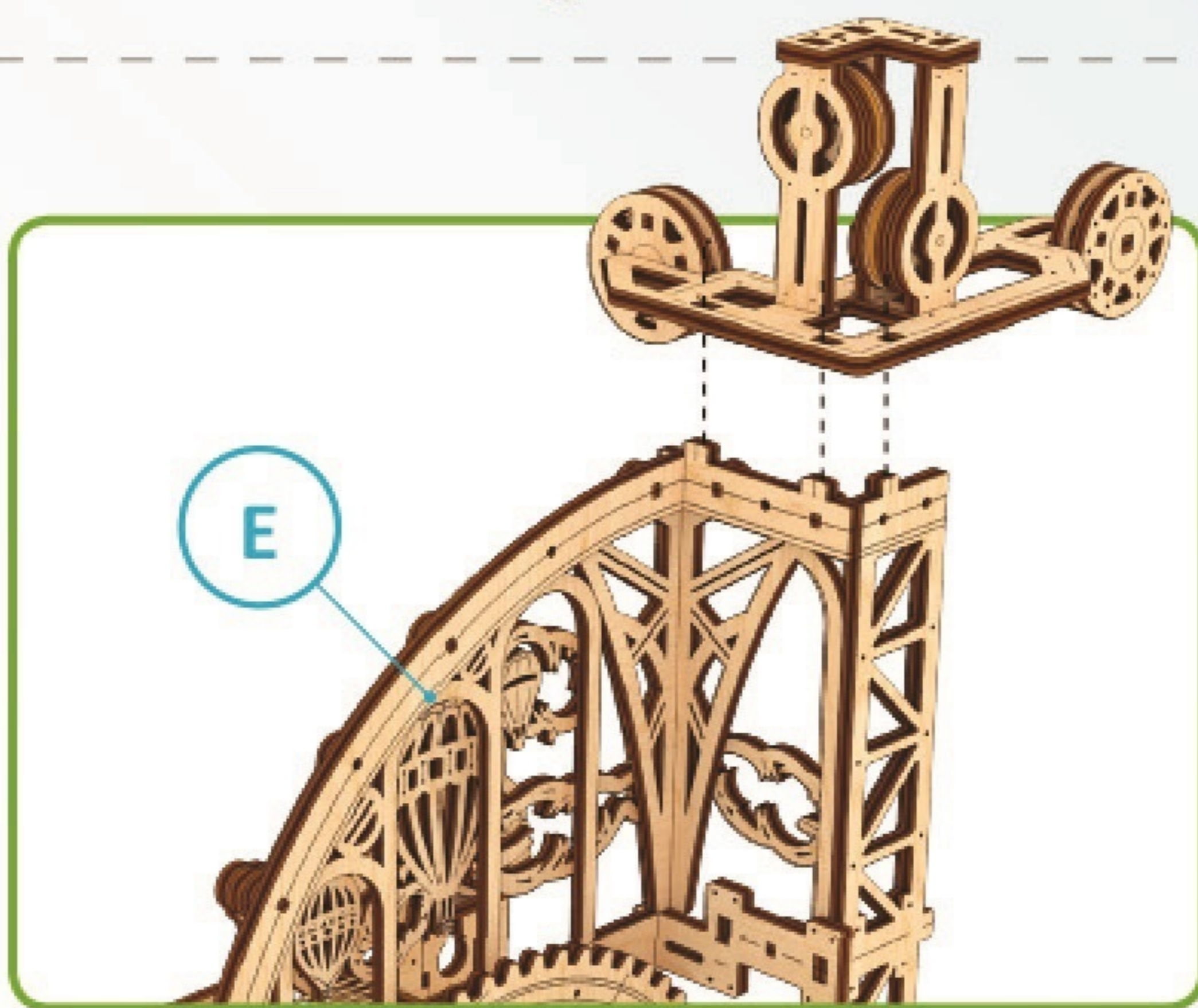

F



 Het onderdeel moet gemakkelijk te draaien zijn.

1

F



2

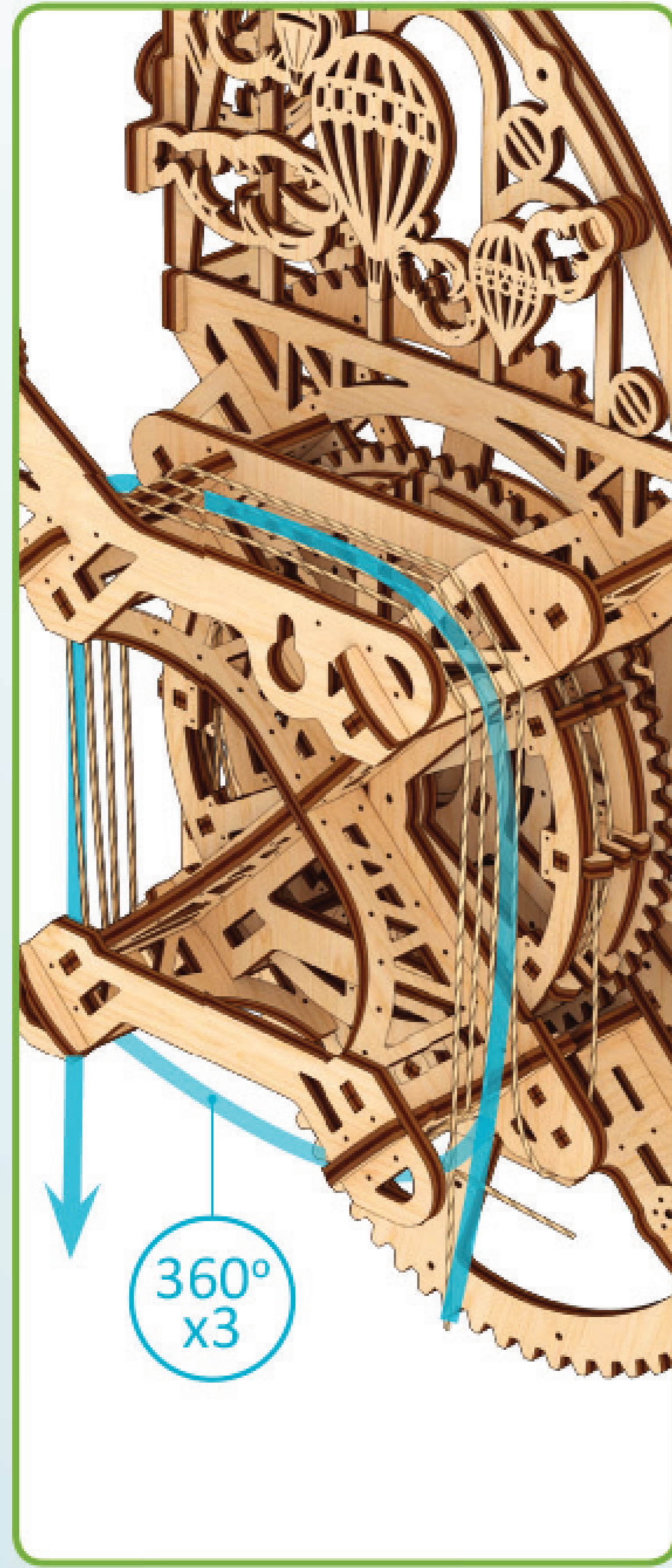

3

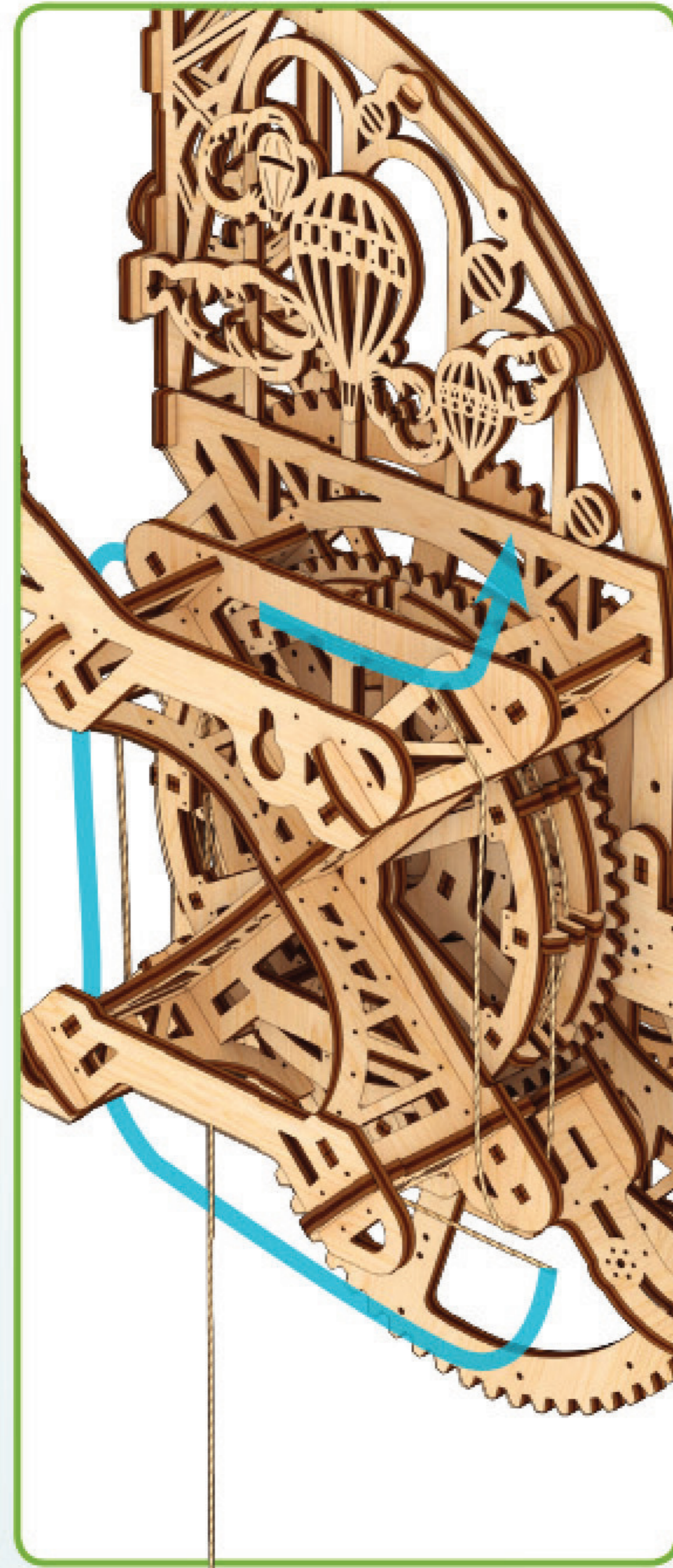

4

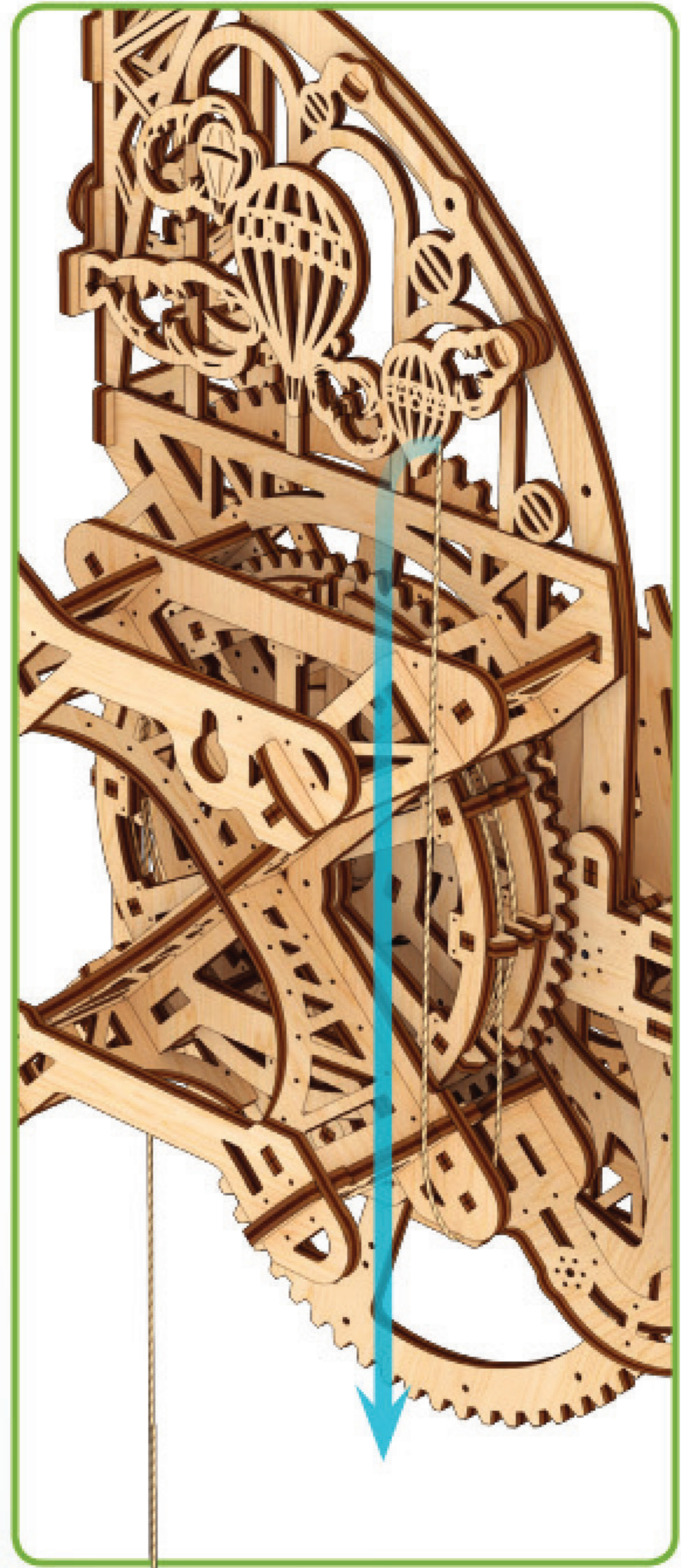

5

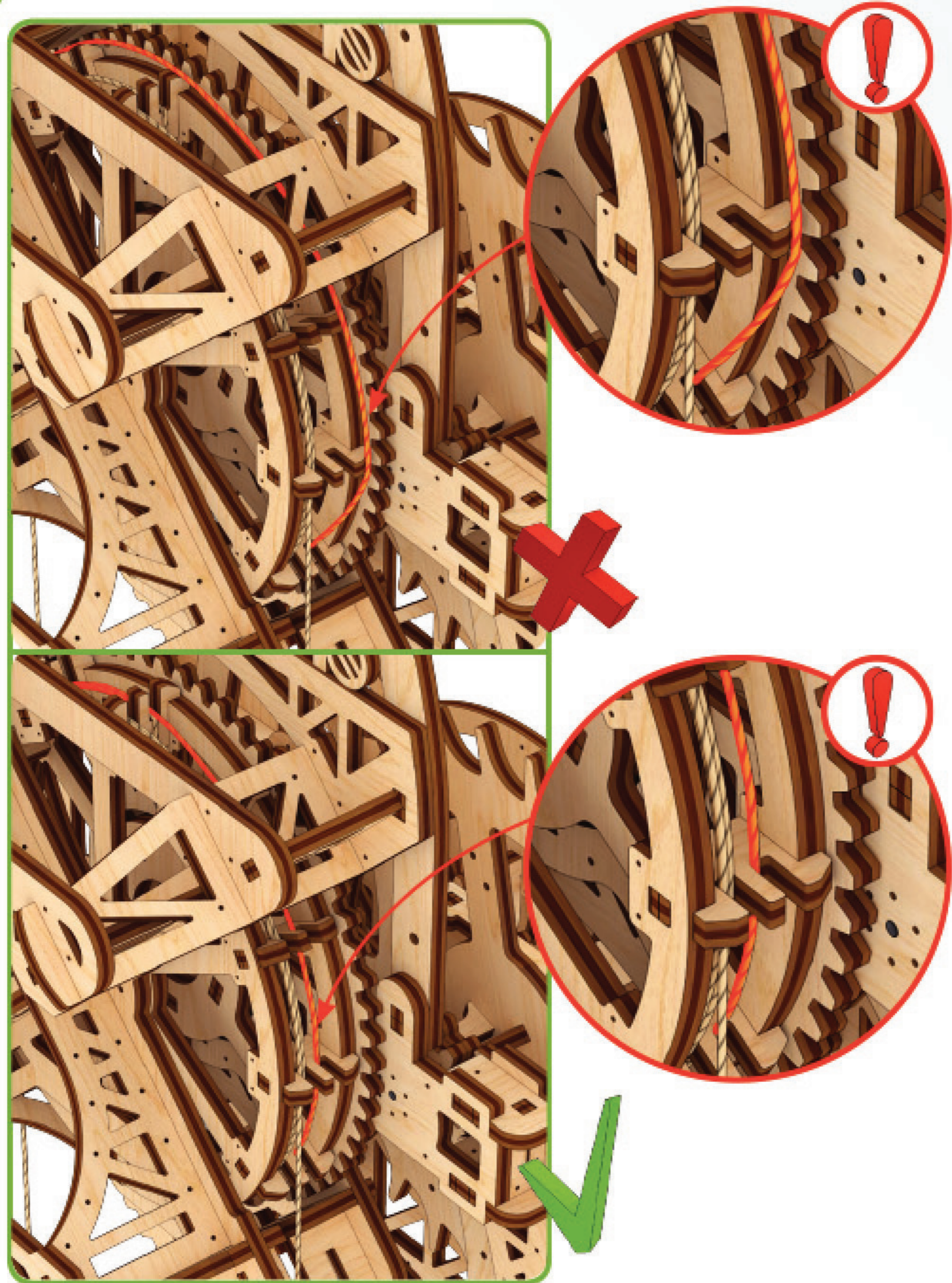

6

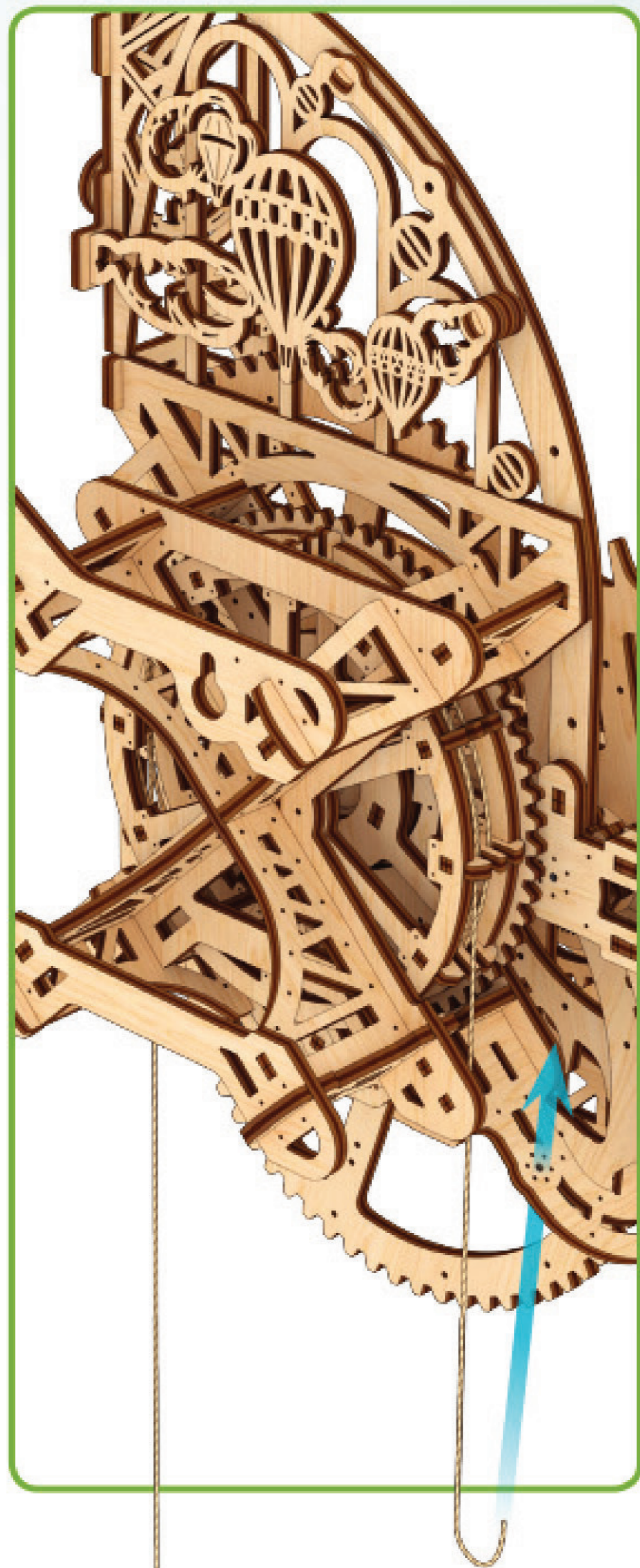

G

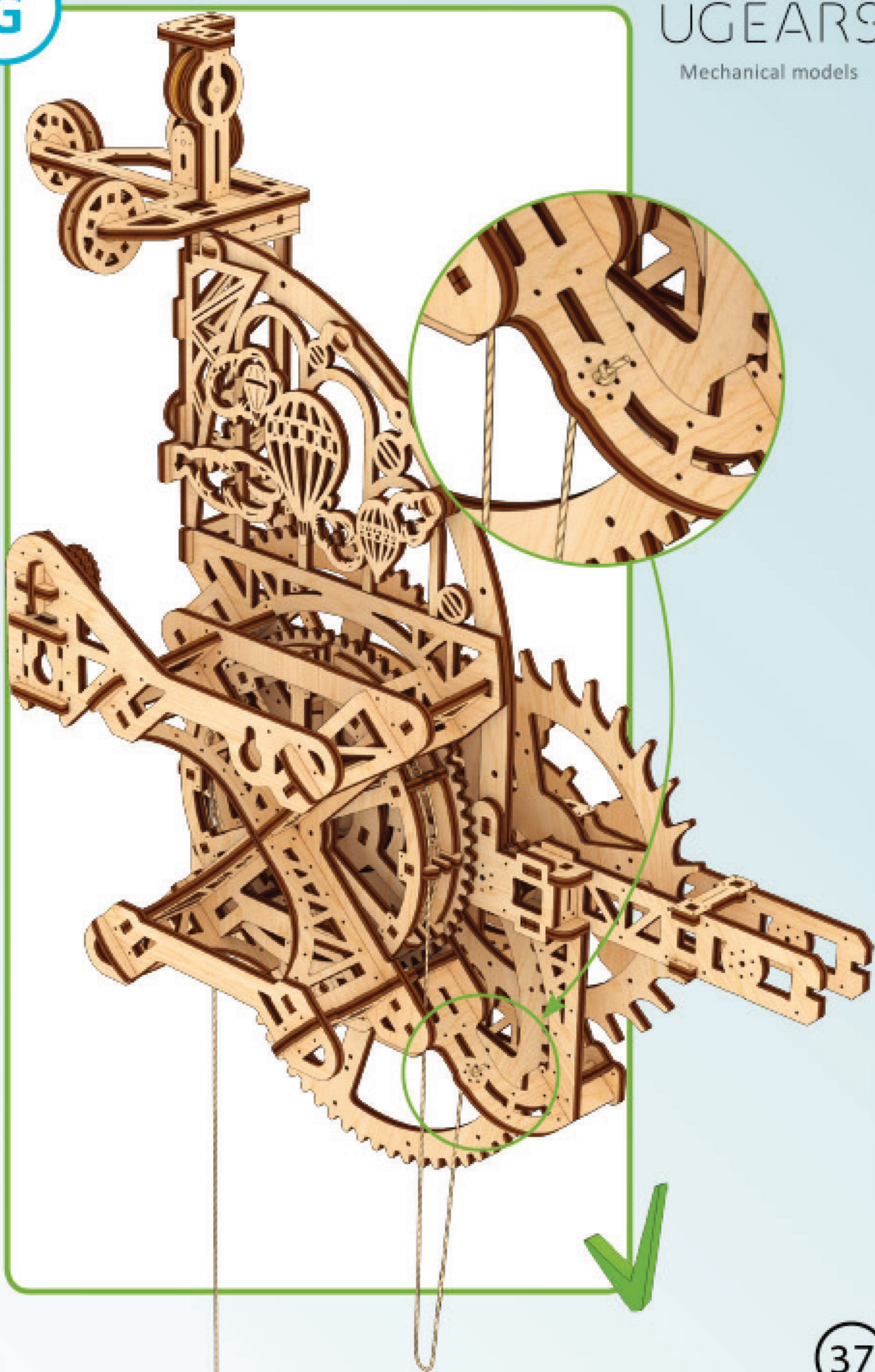

De optimale hoogte voor de klok is 1m 80cm van de vloer tot de houder. Door het model op de gespecificeerde hoogte te plaatsen, kan het model 12 uur worden gebruikt (uitgaande van een correcte opstelling\*).



h ≈ 5ft 9inch/  
1m 80cm

\*



U kunt het model aan de muur hangen voor een gemakkelijke montage van de verschillende klokmechanismes.

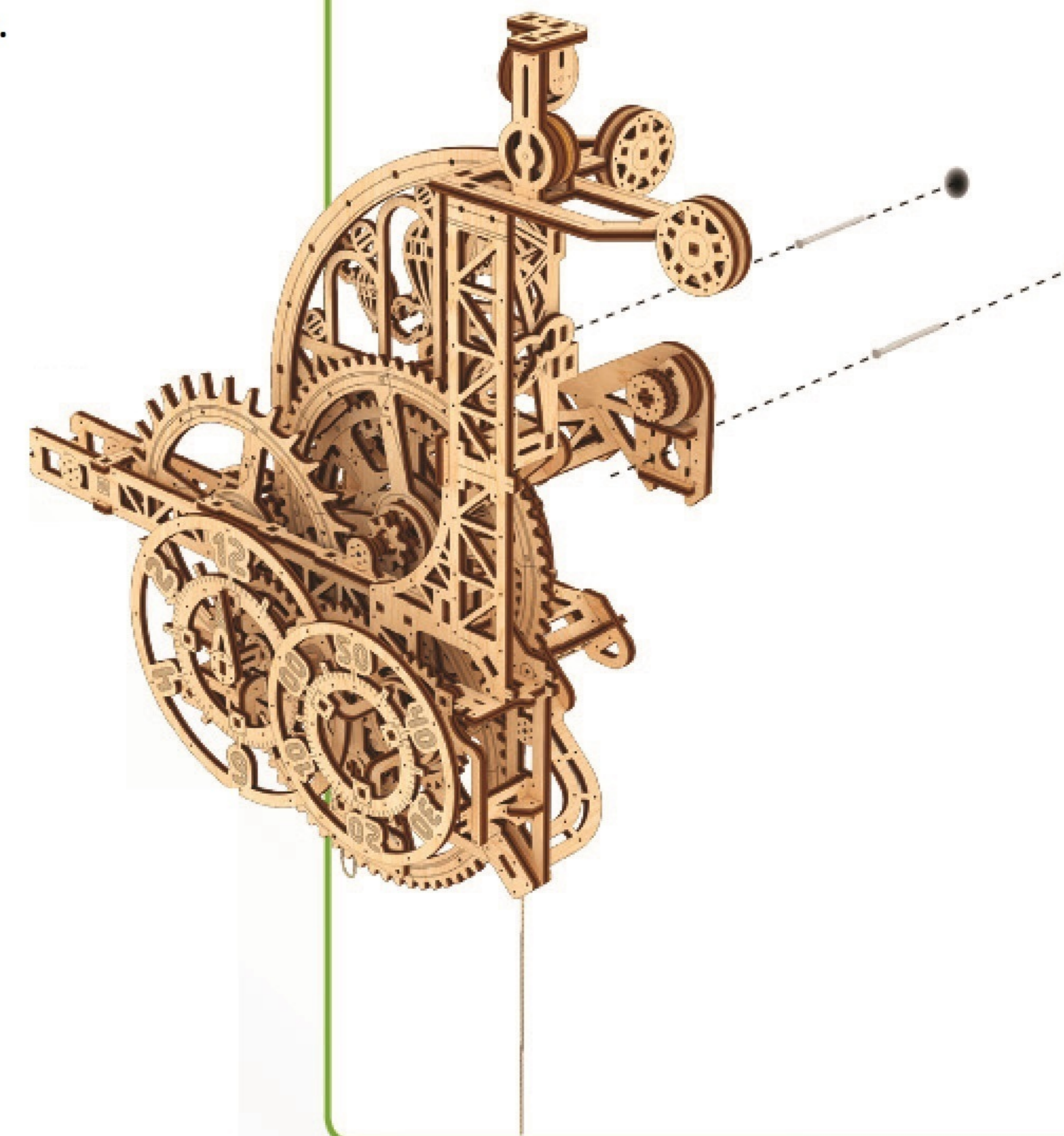



Gebruik dit blad als een levensgroot patroon voor de juiste plaatsing van de beugels aan de muur.\*

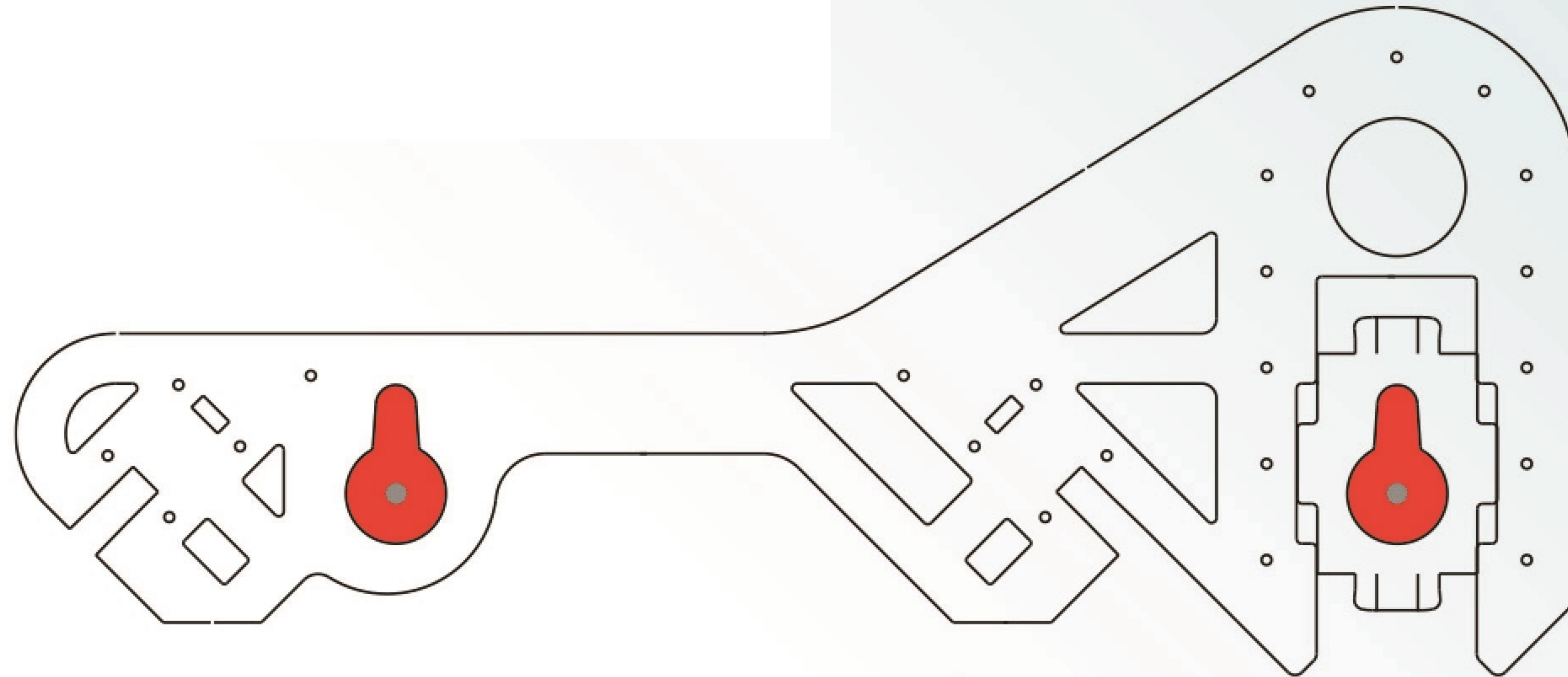

\*Schroeven voor montage niet inbegrepen.





- 1) Rollers.
- 2) Draaiwiel.
- 3) Urenschijf.
- 4) Wijzerplaat.
- 5) Minutenschijf.
- 6) Excentrische knop.
- 7) Gewaxt Koord.

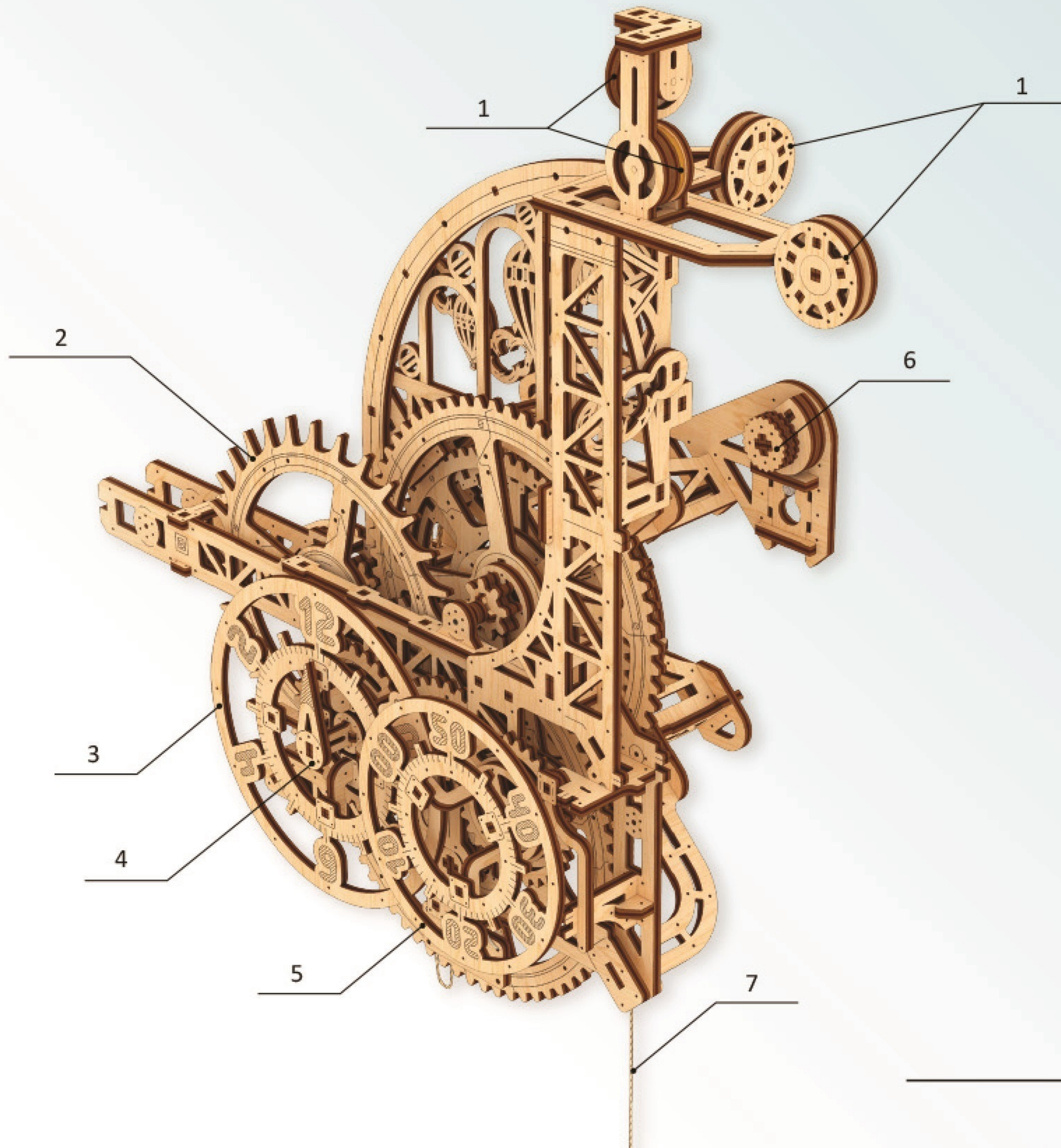

Zet het gemonteerde model waterpas. \* Nadat u het gemonteerde model aan de muur hebt gehangen, moet u ervoor zorgen dat het waterpas staat om de mechanismen correct te laten werken. Zet hiervoor uw waterpasinstrument op de horizontale balk van de klokbehuizing, parallel aan de muur. Zoek de excentrische knop en draai deze naar links of rechts totdat het gemonteerde model waterpas staat.

1

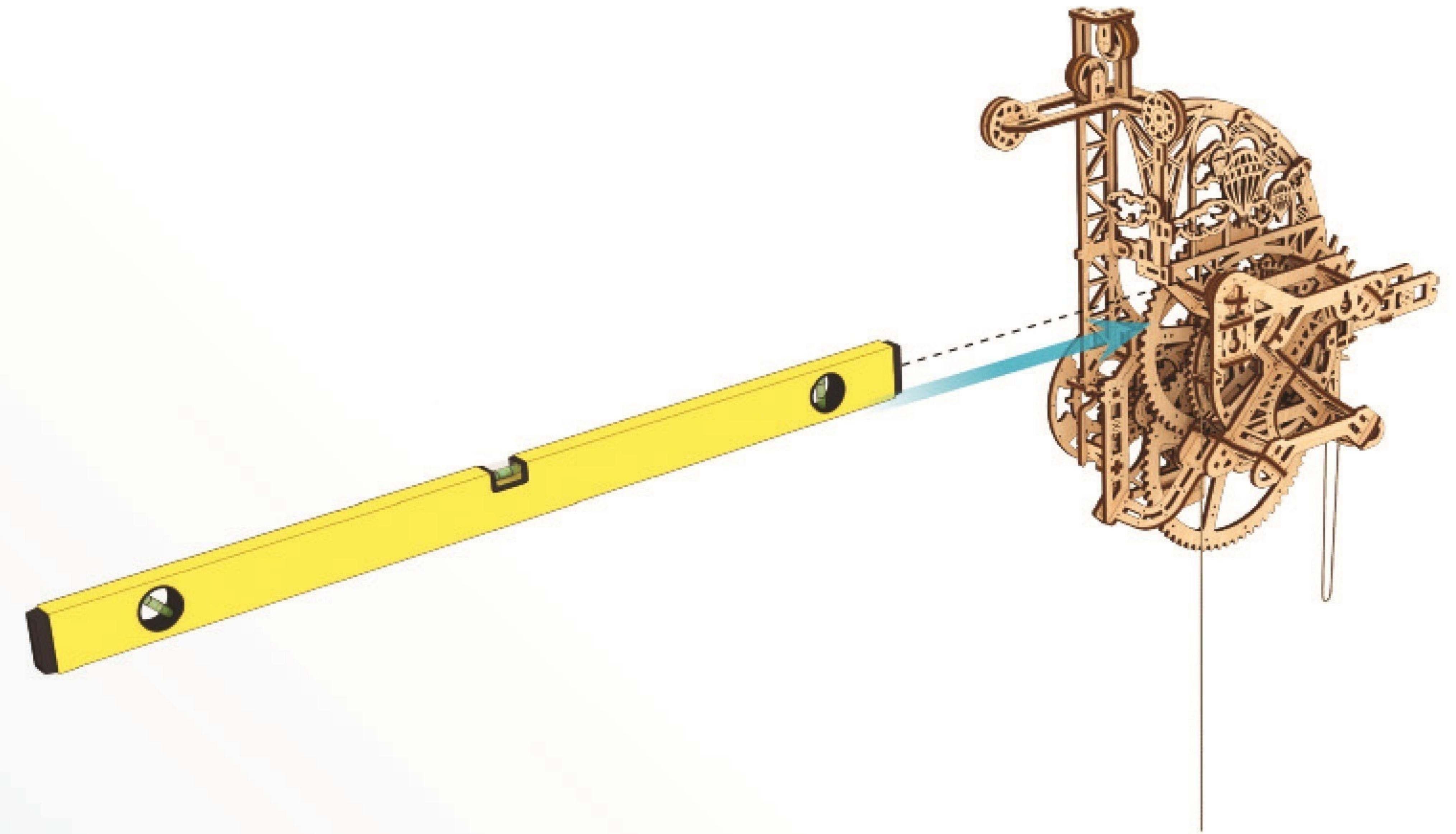

\*Waterpas niet inbegrepen

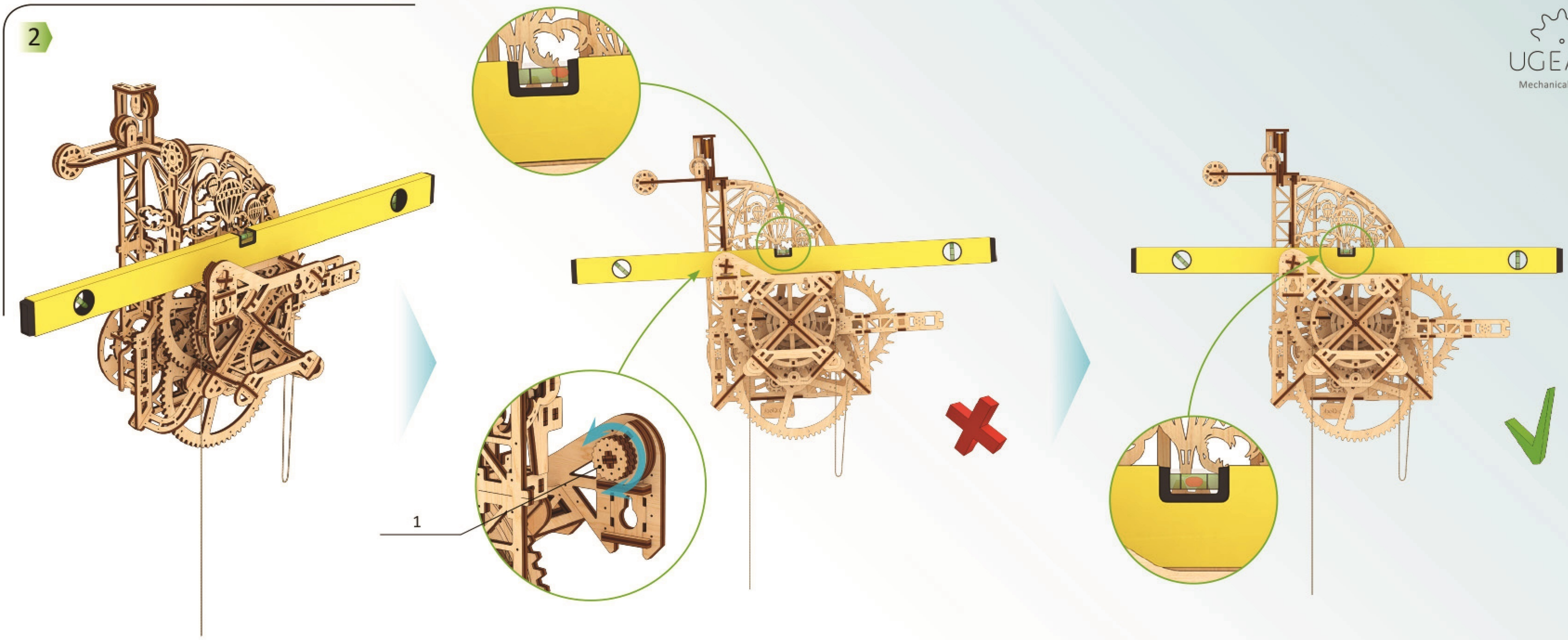

1 - Excentrische knop

Mechanical models

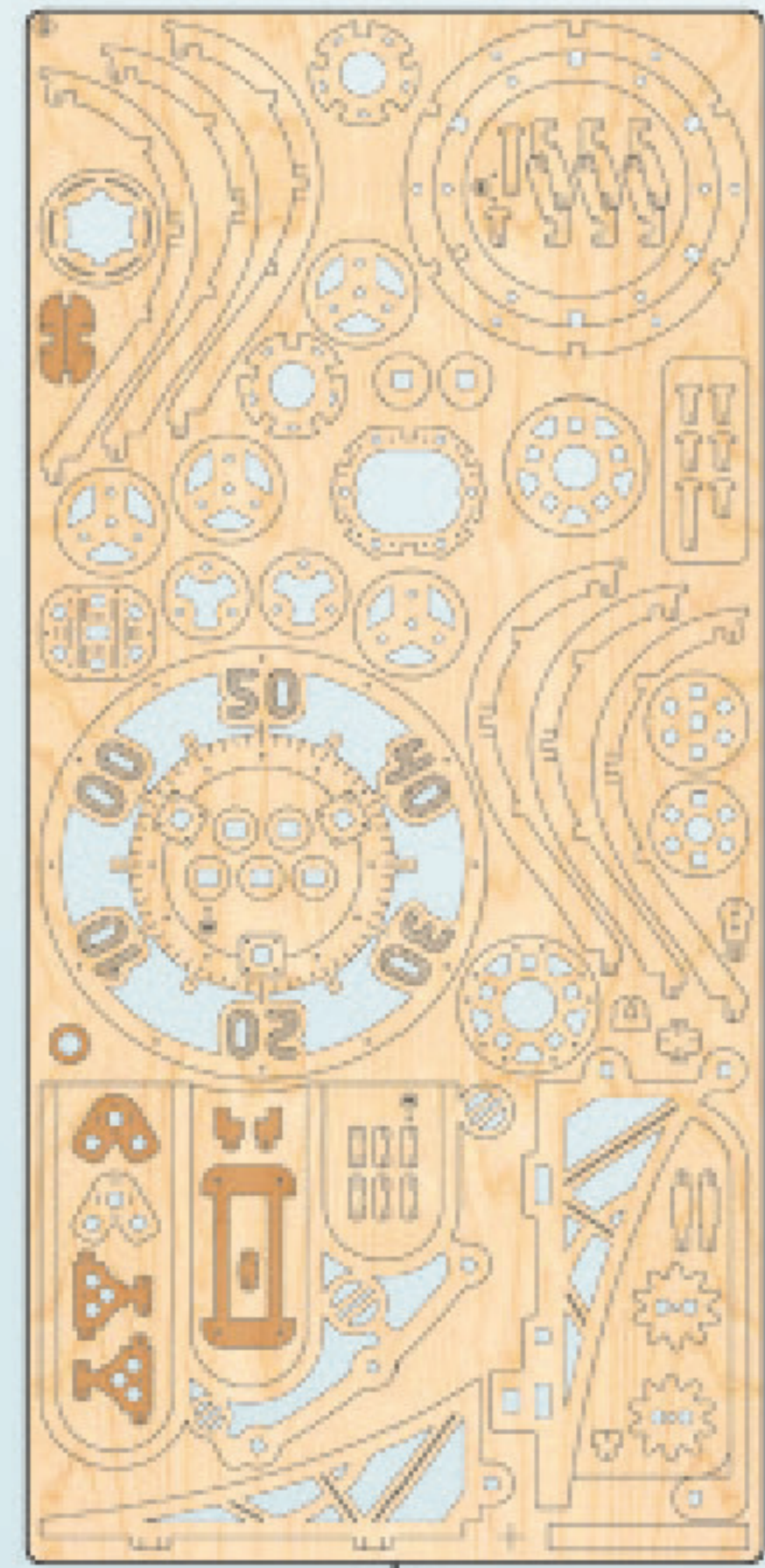

8

1

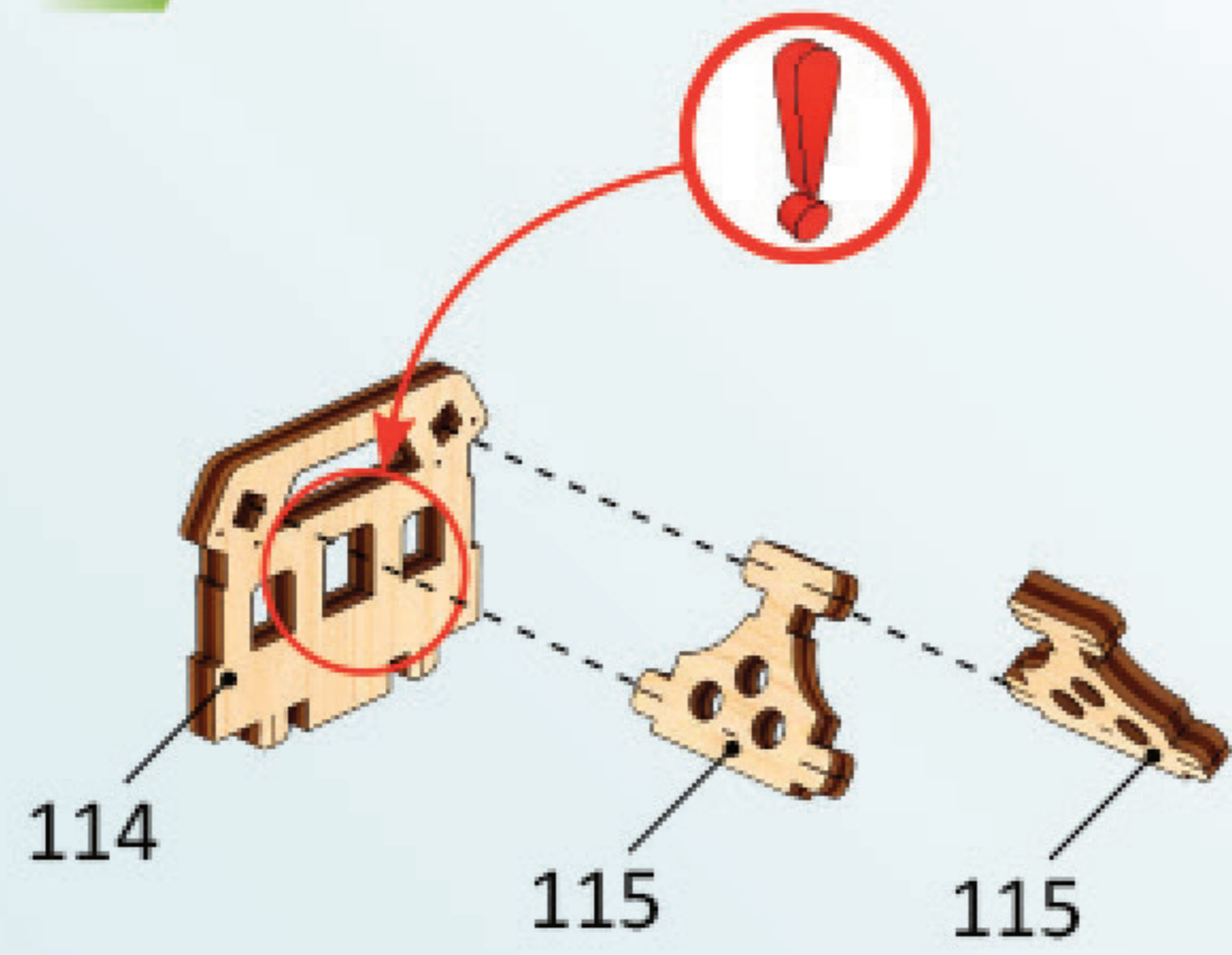

2

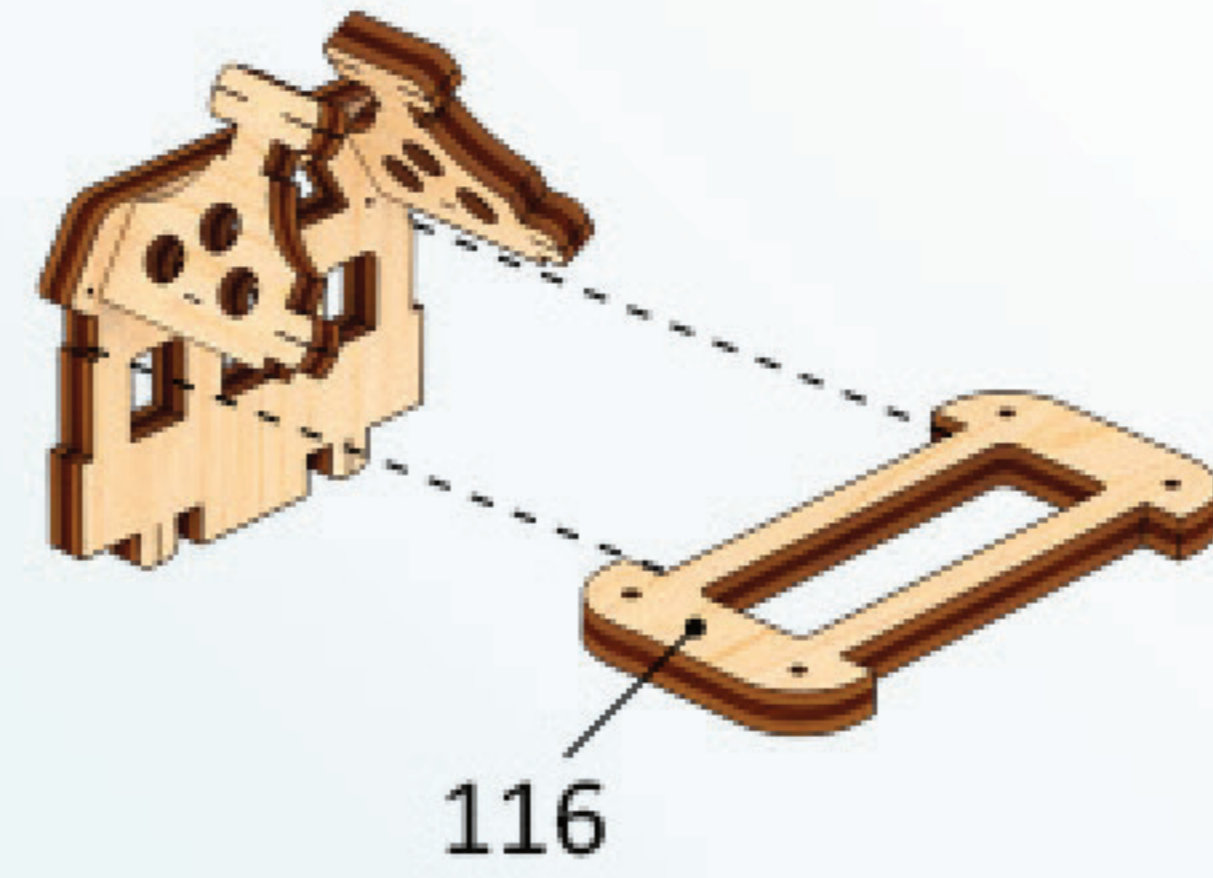

3

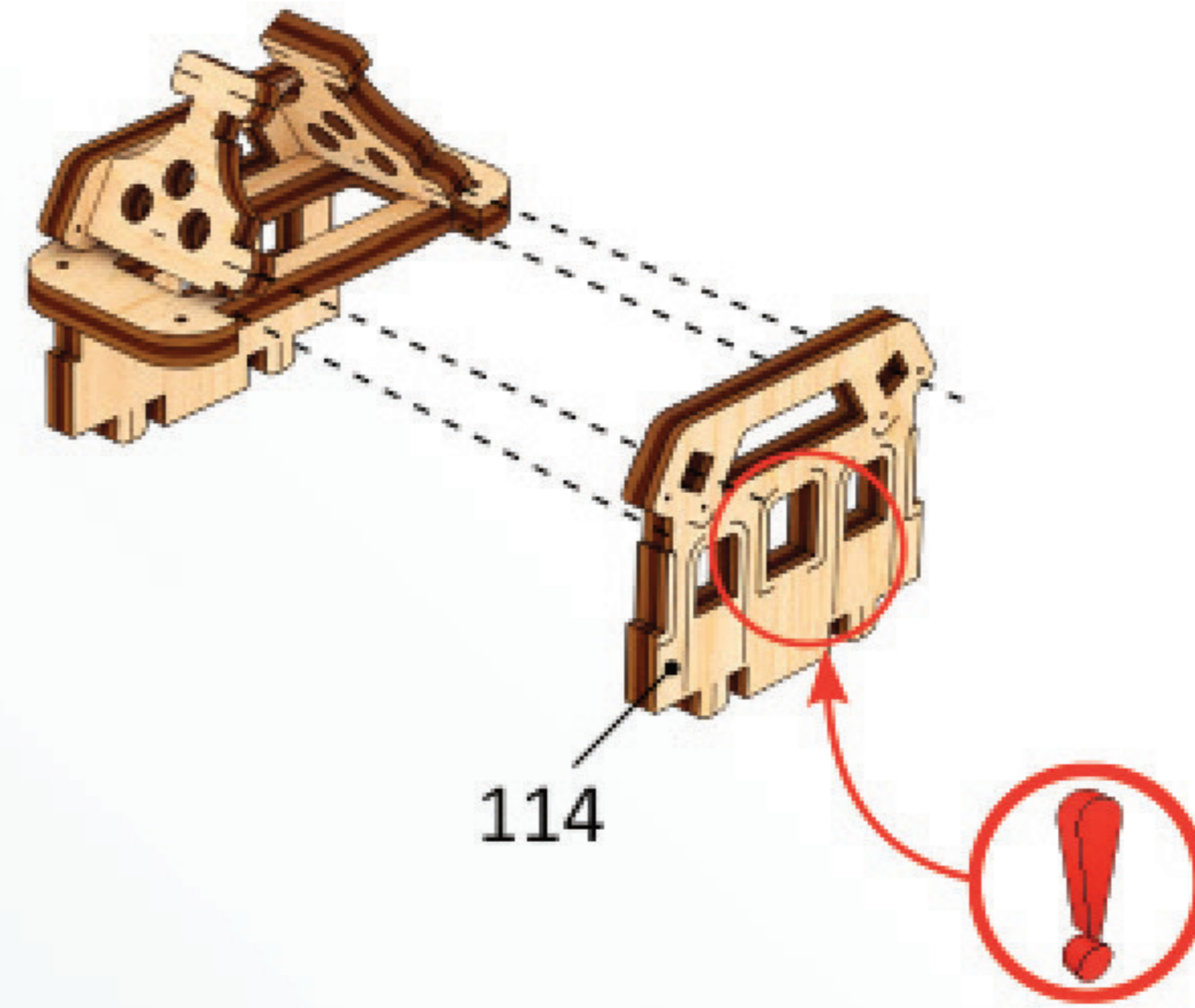

4

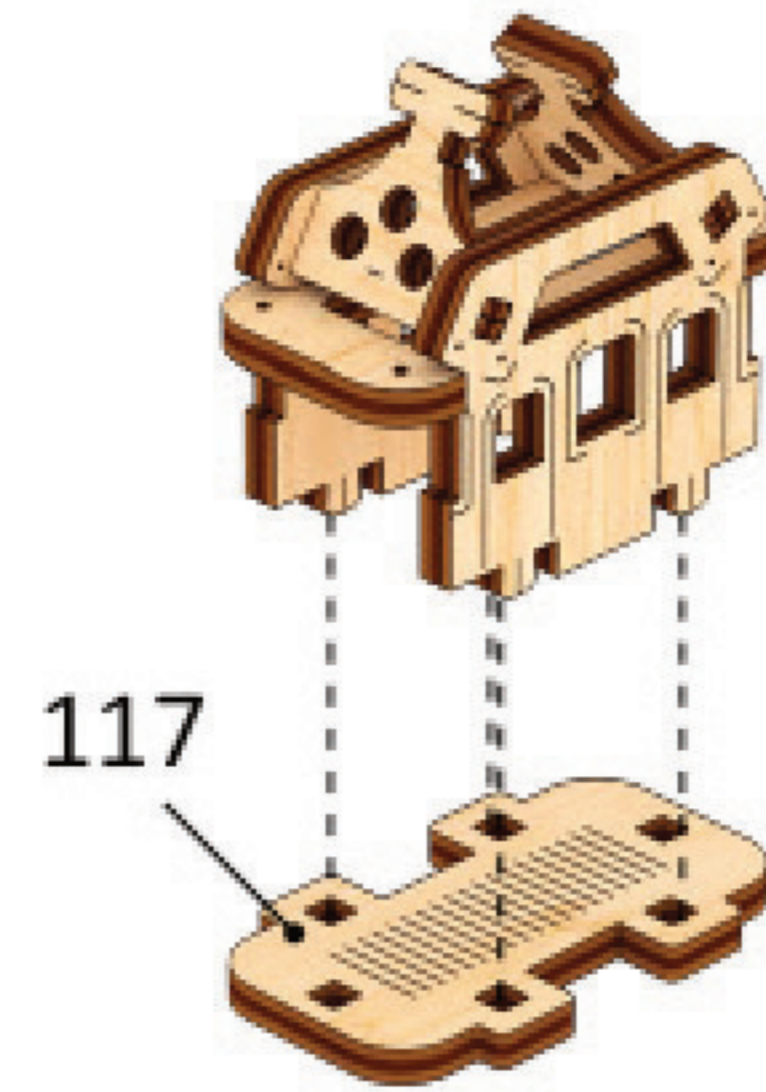

5

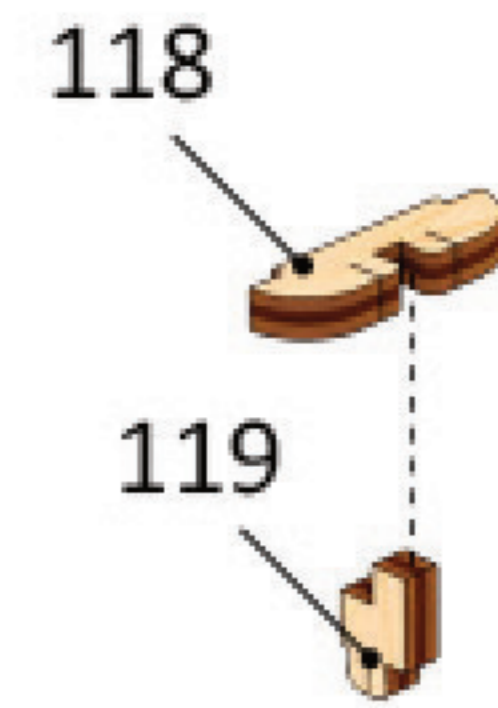

x2

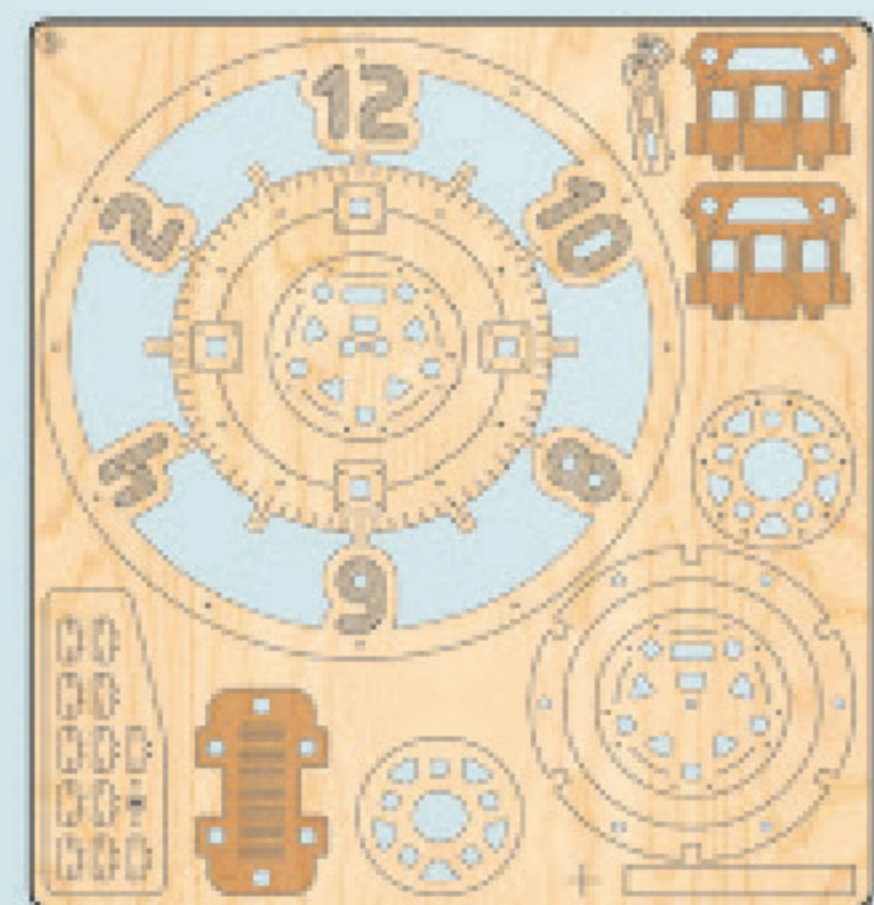

9

6

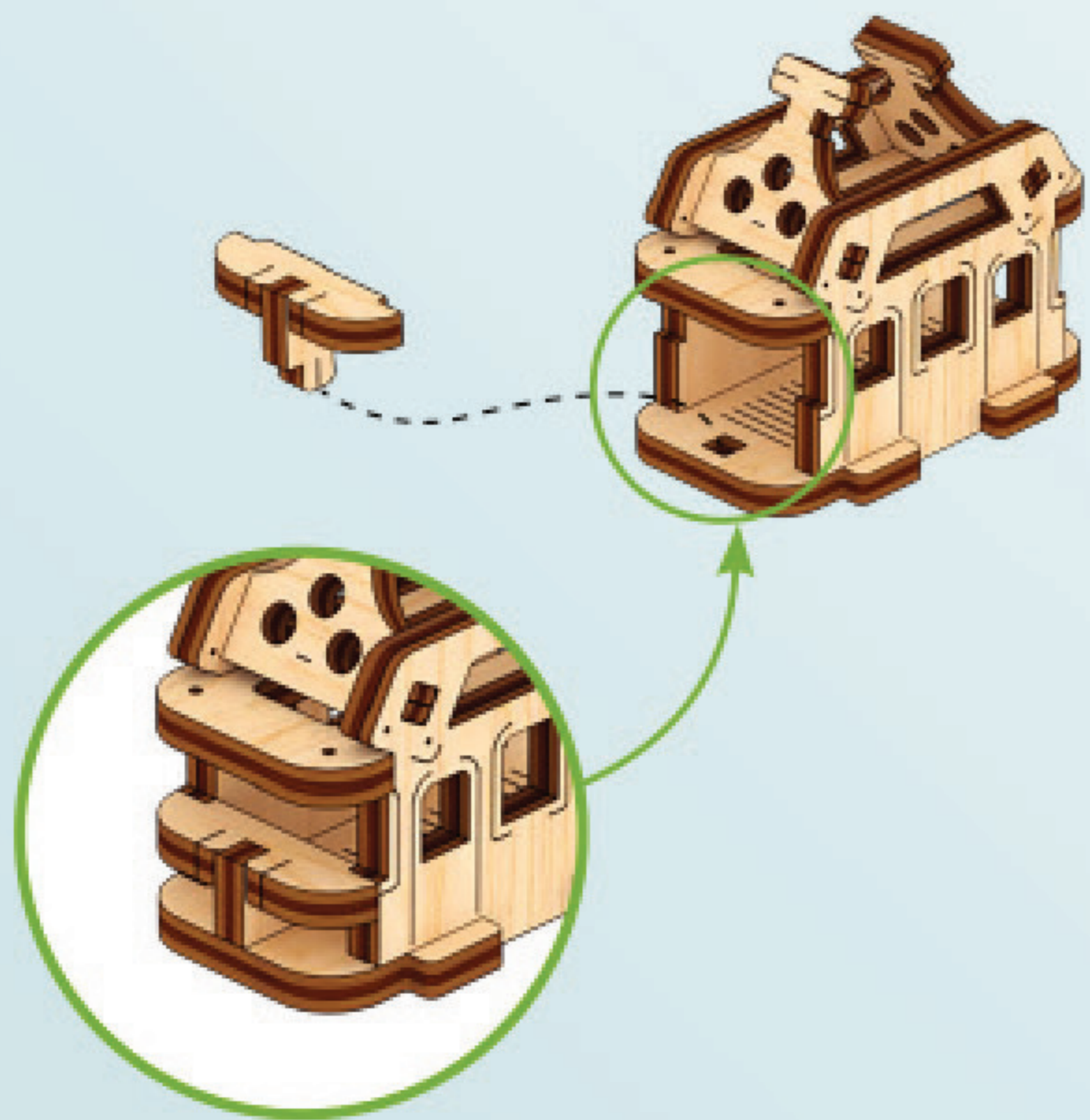

7

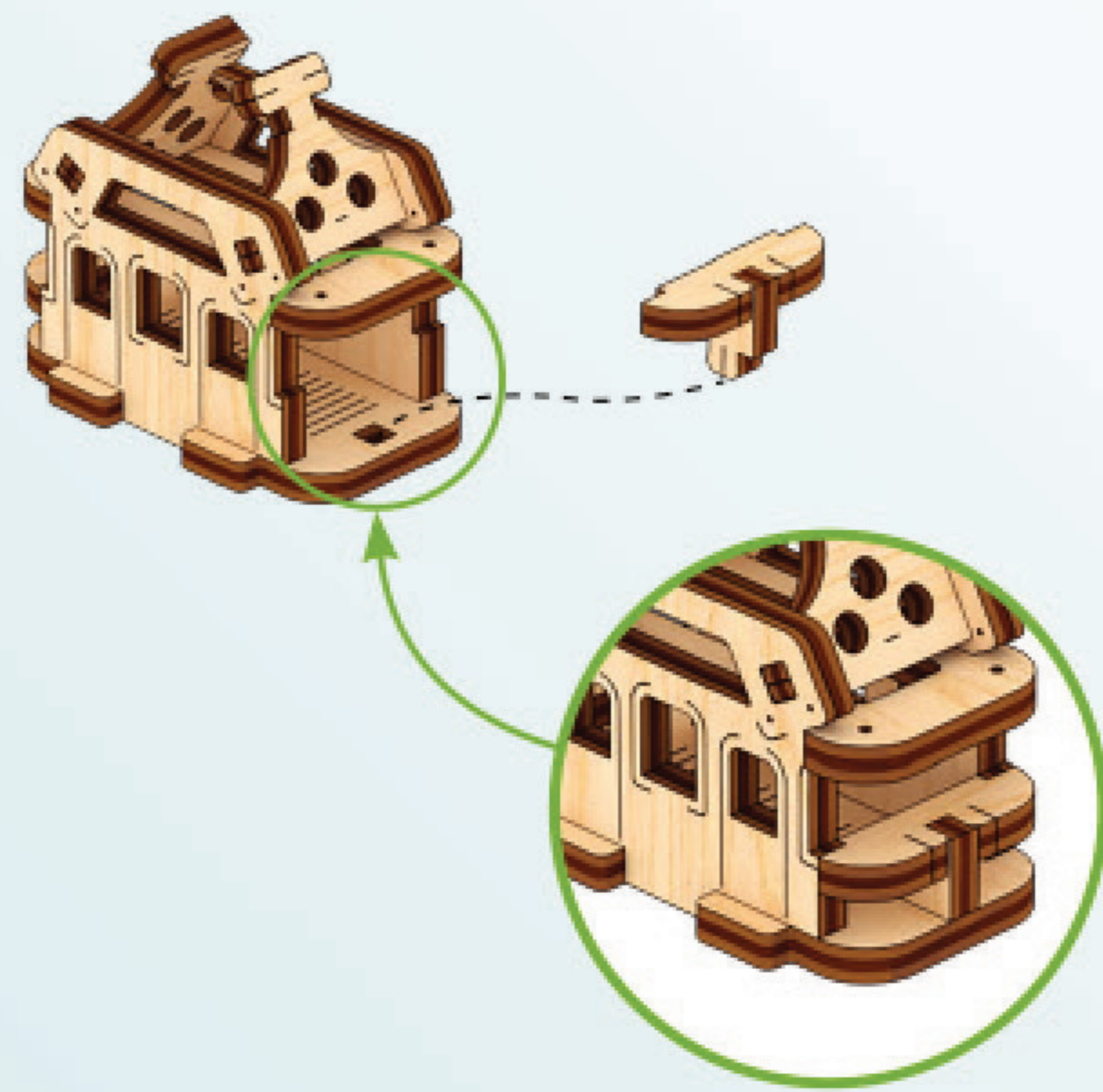

8

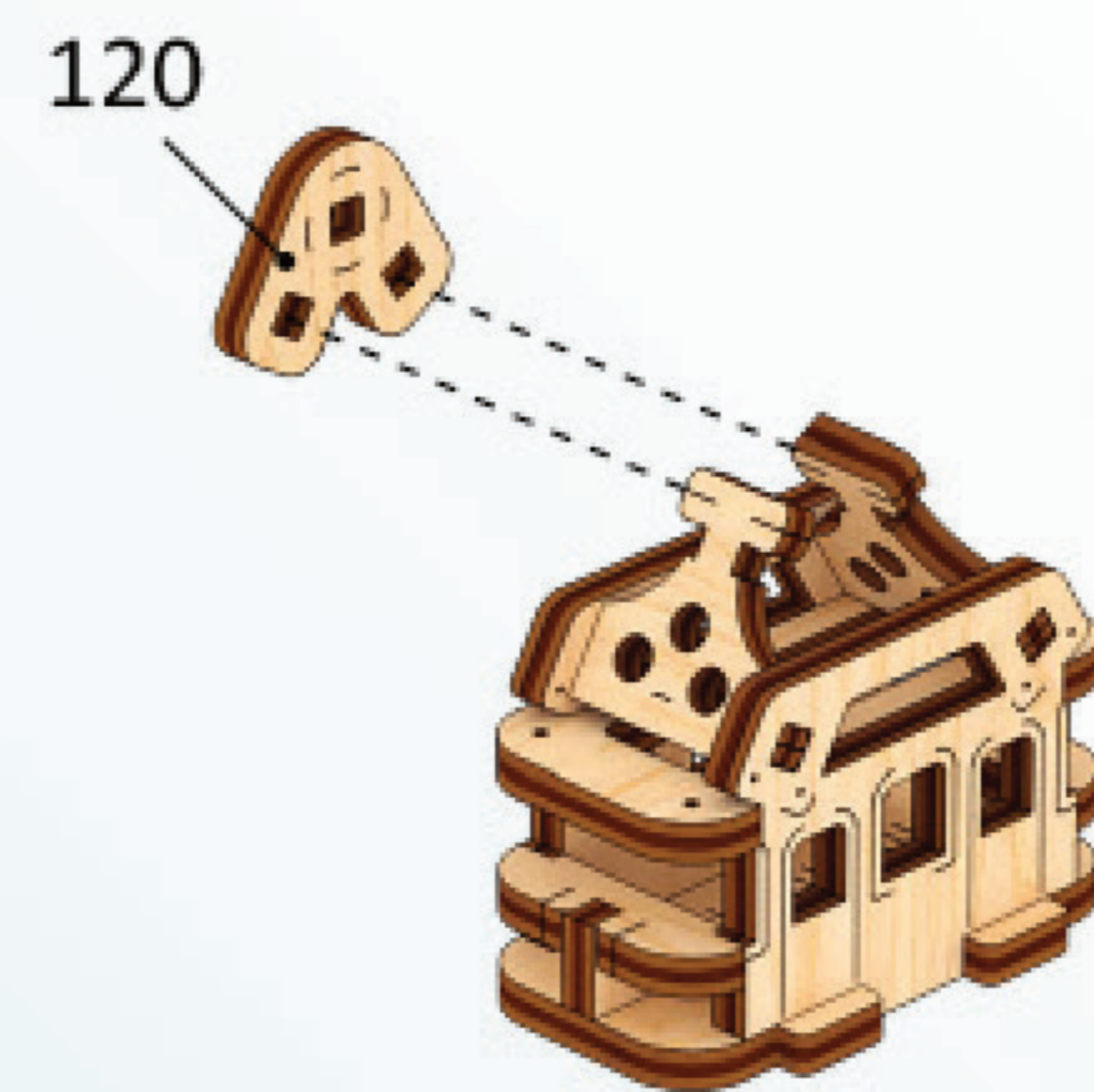

9

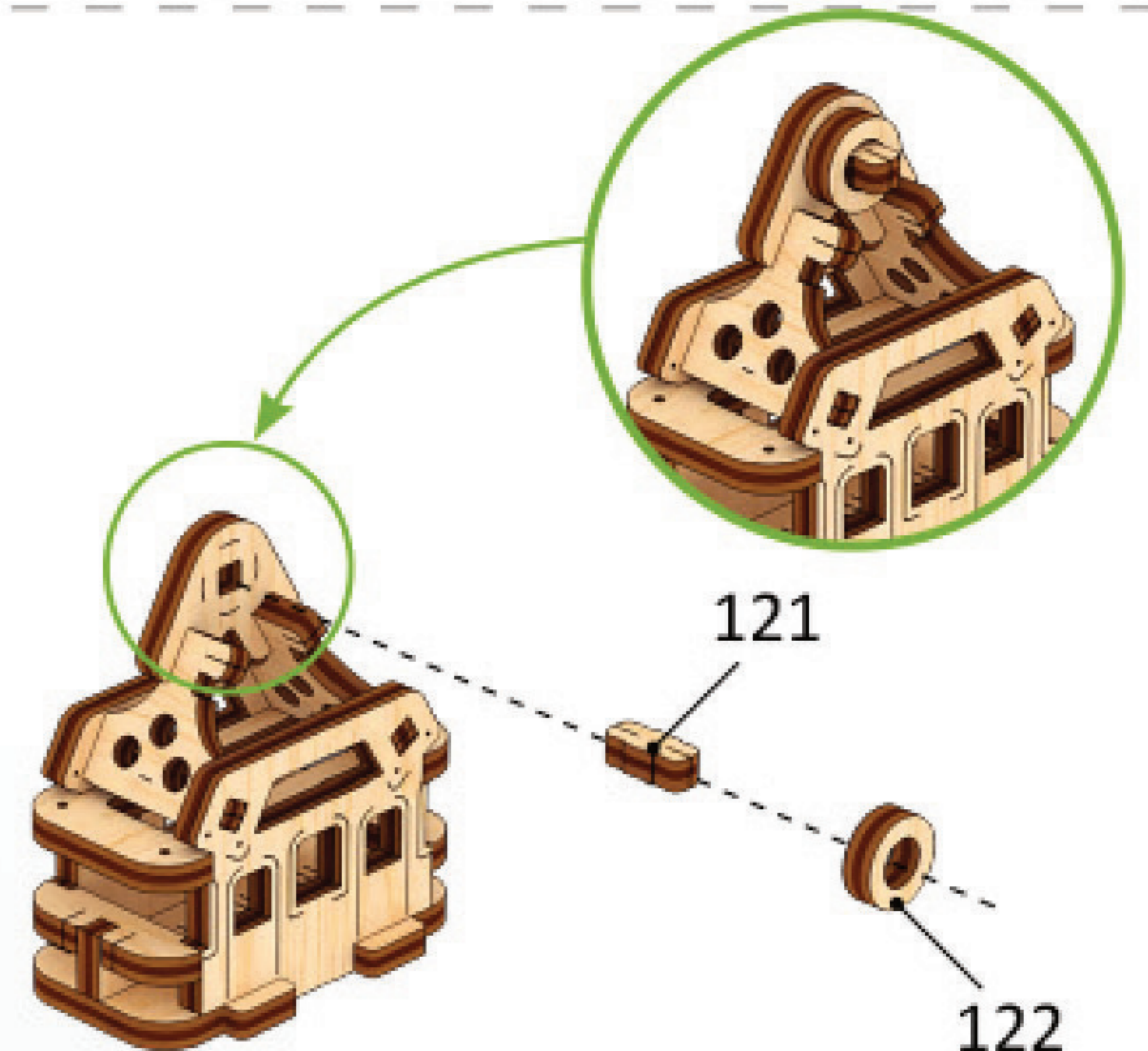

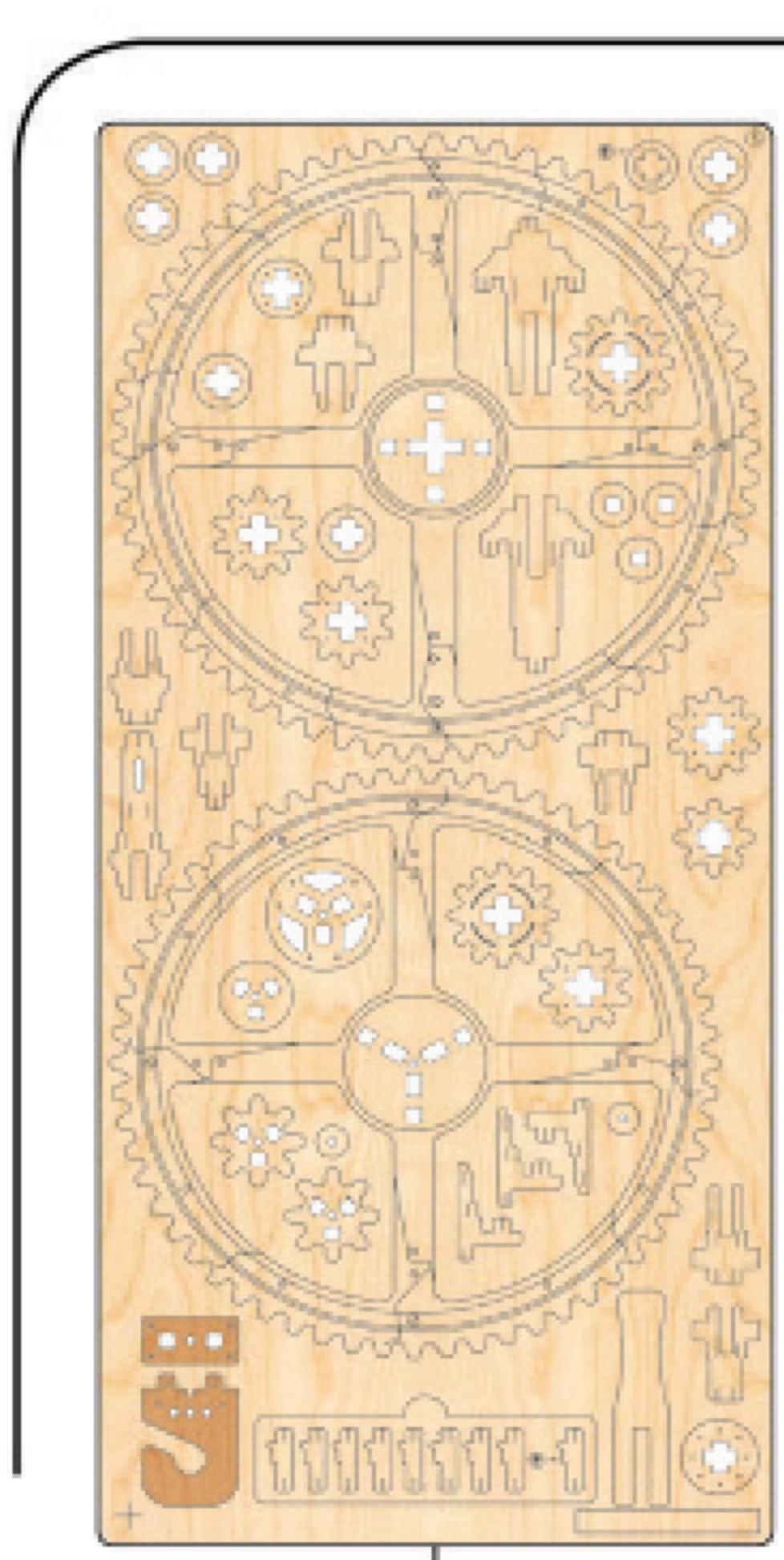

10

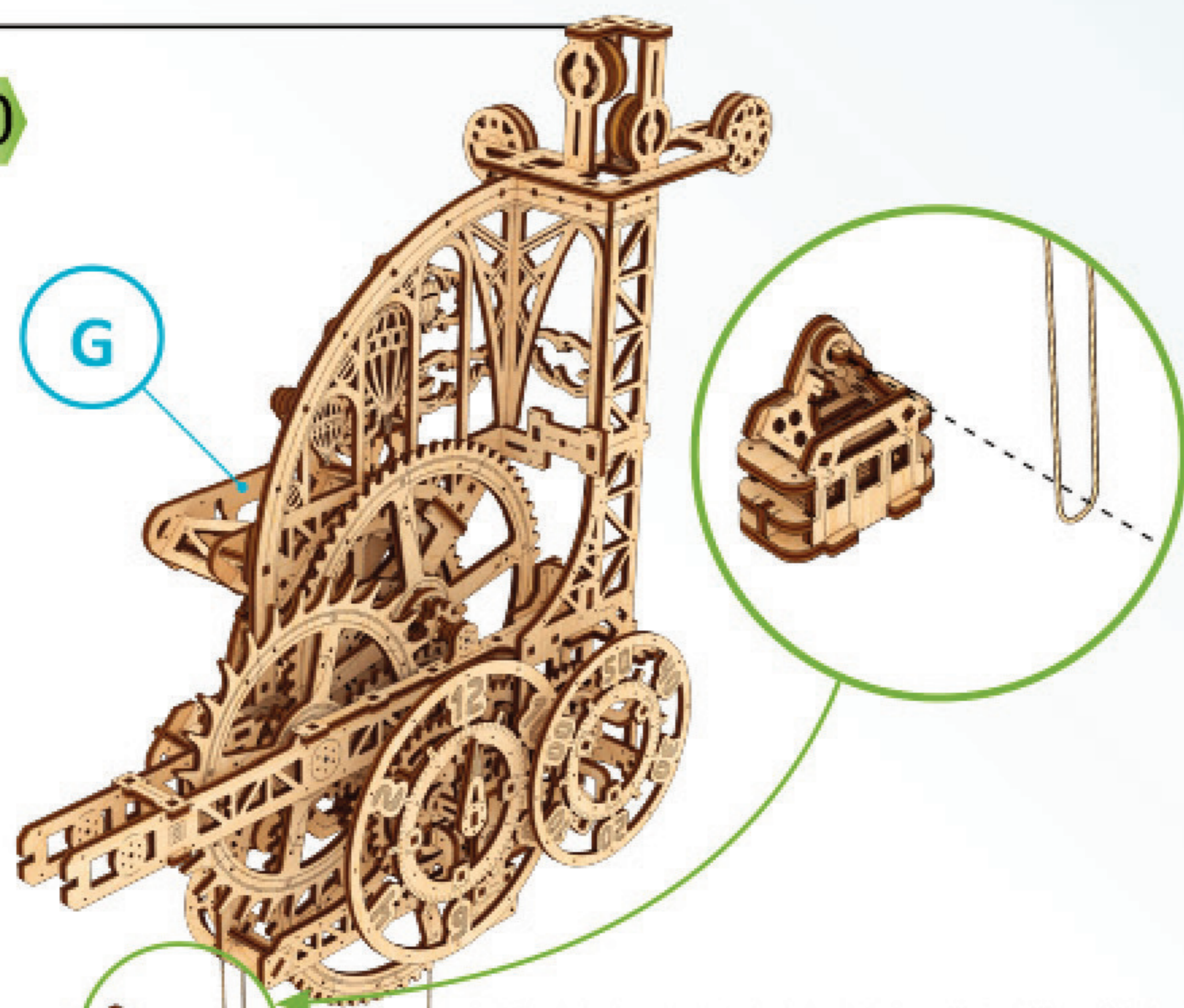

11

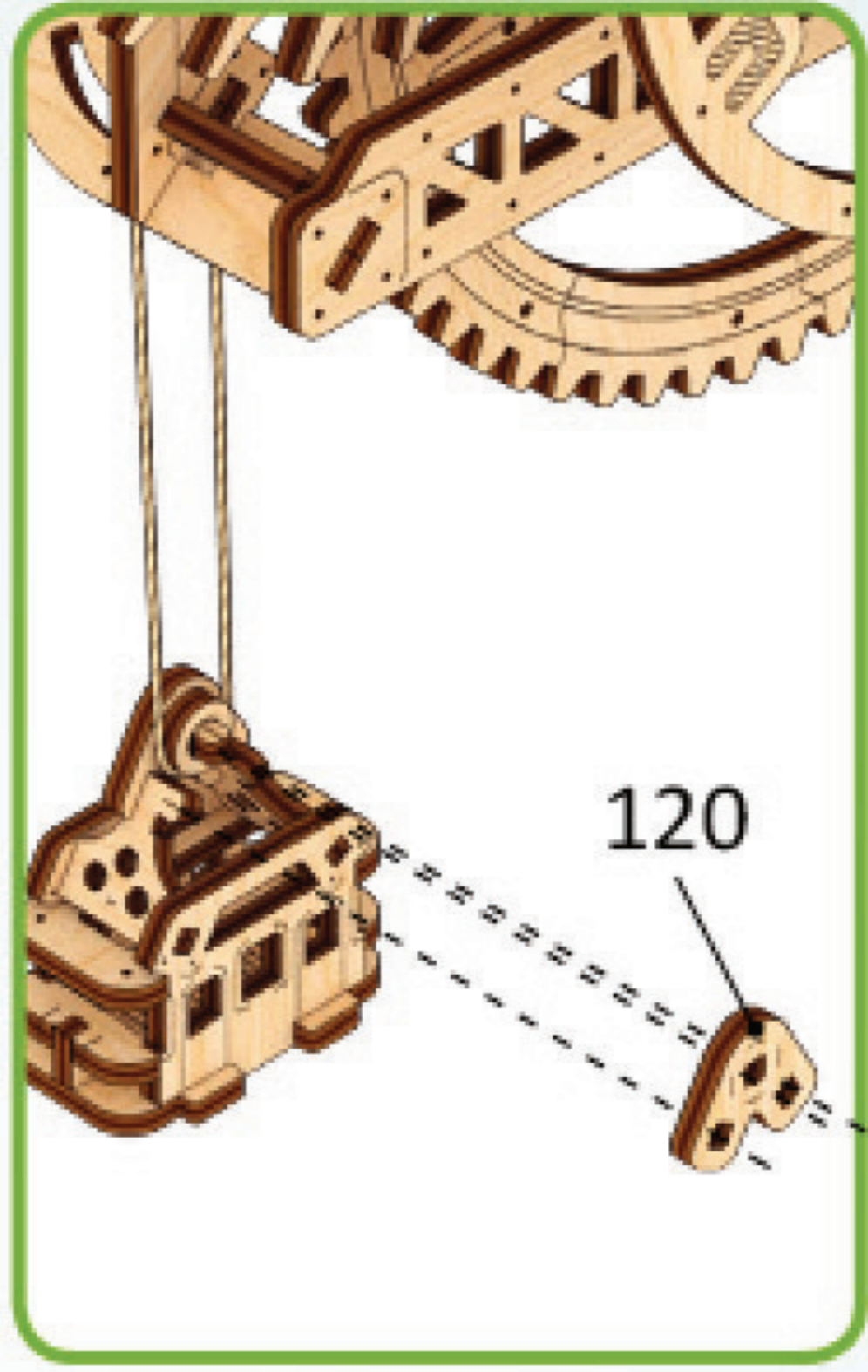

12

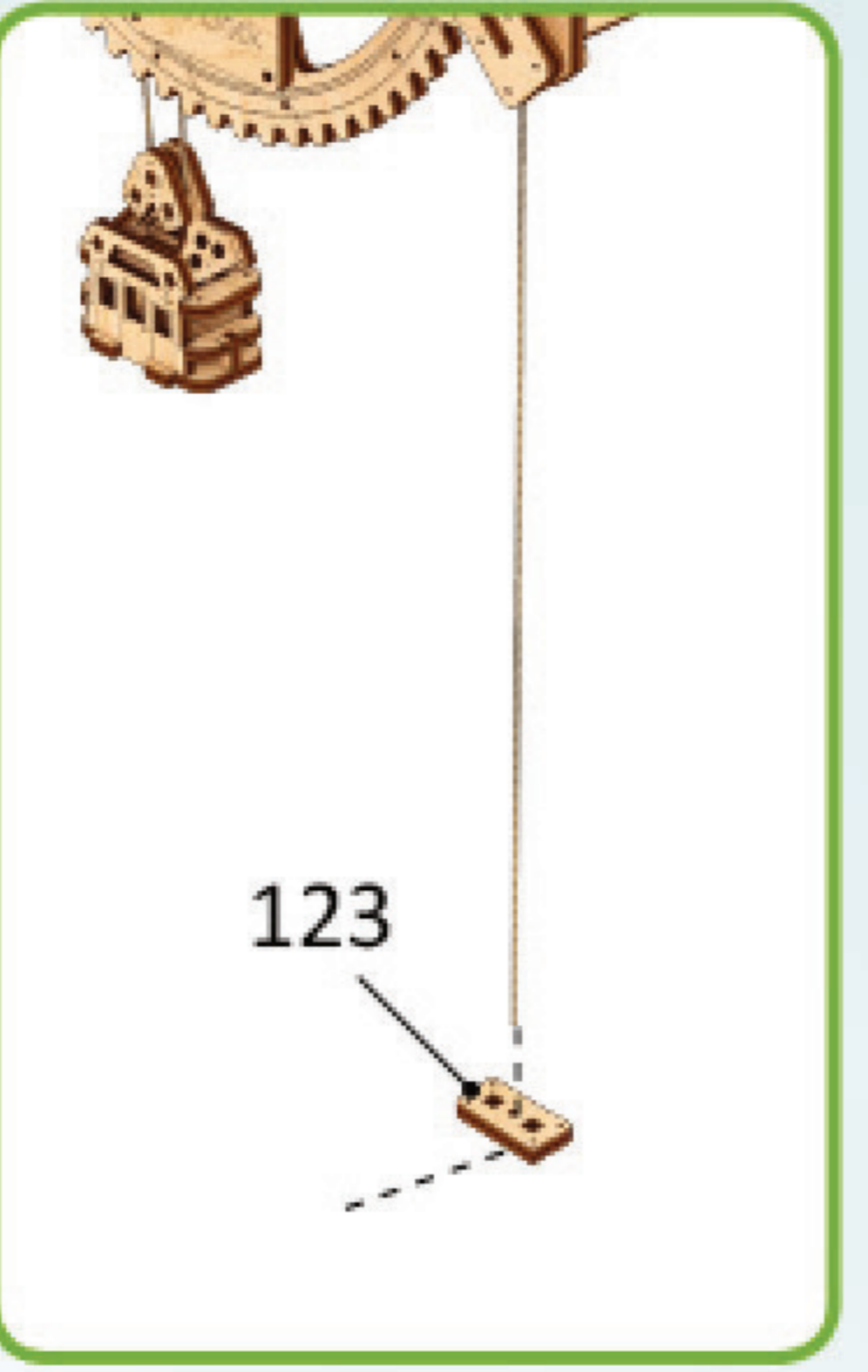

13

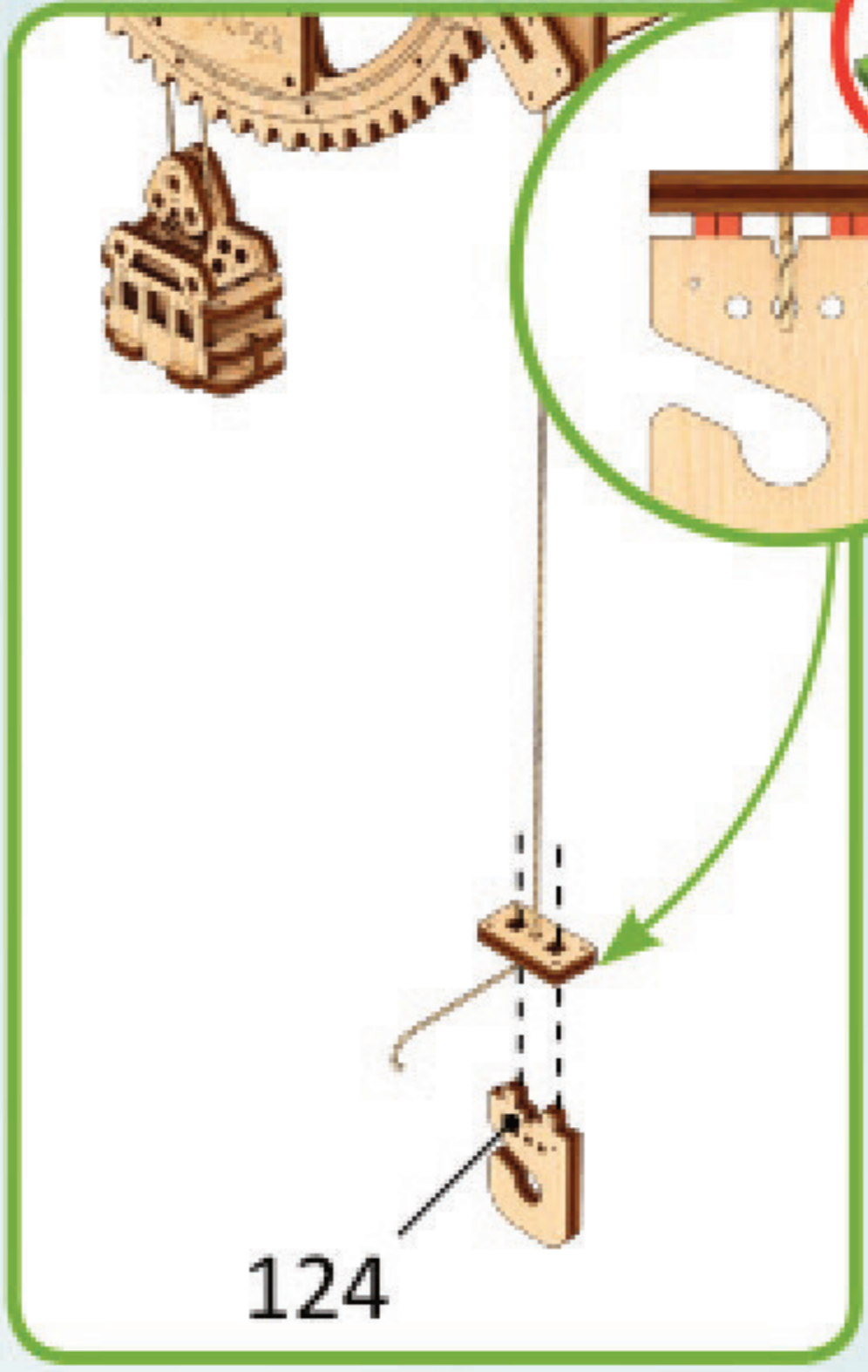

H

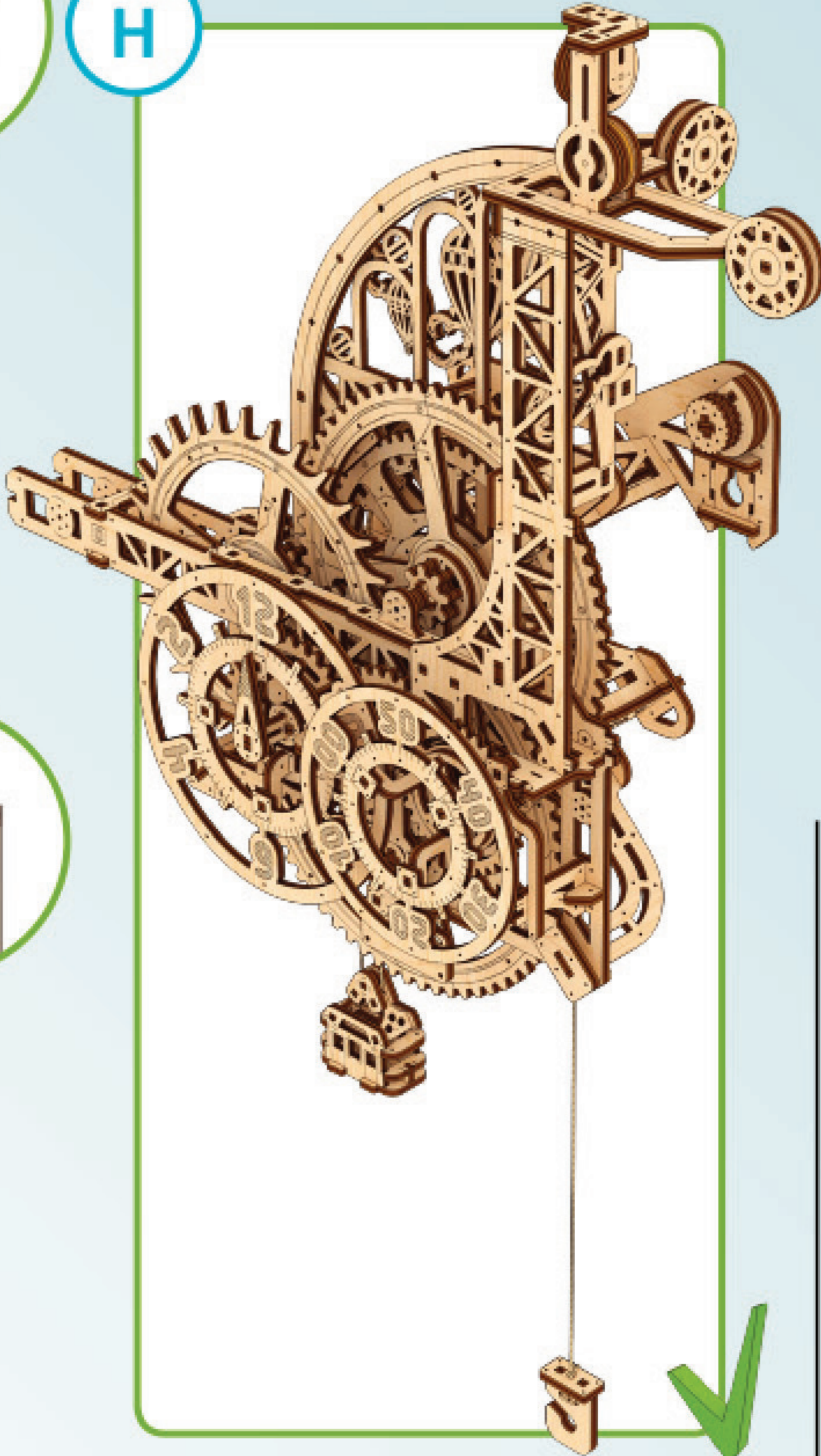

14

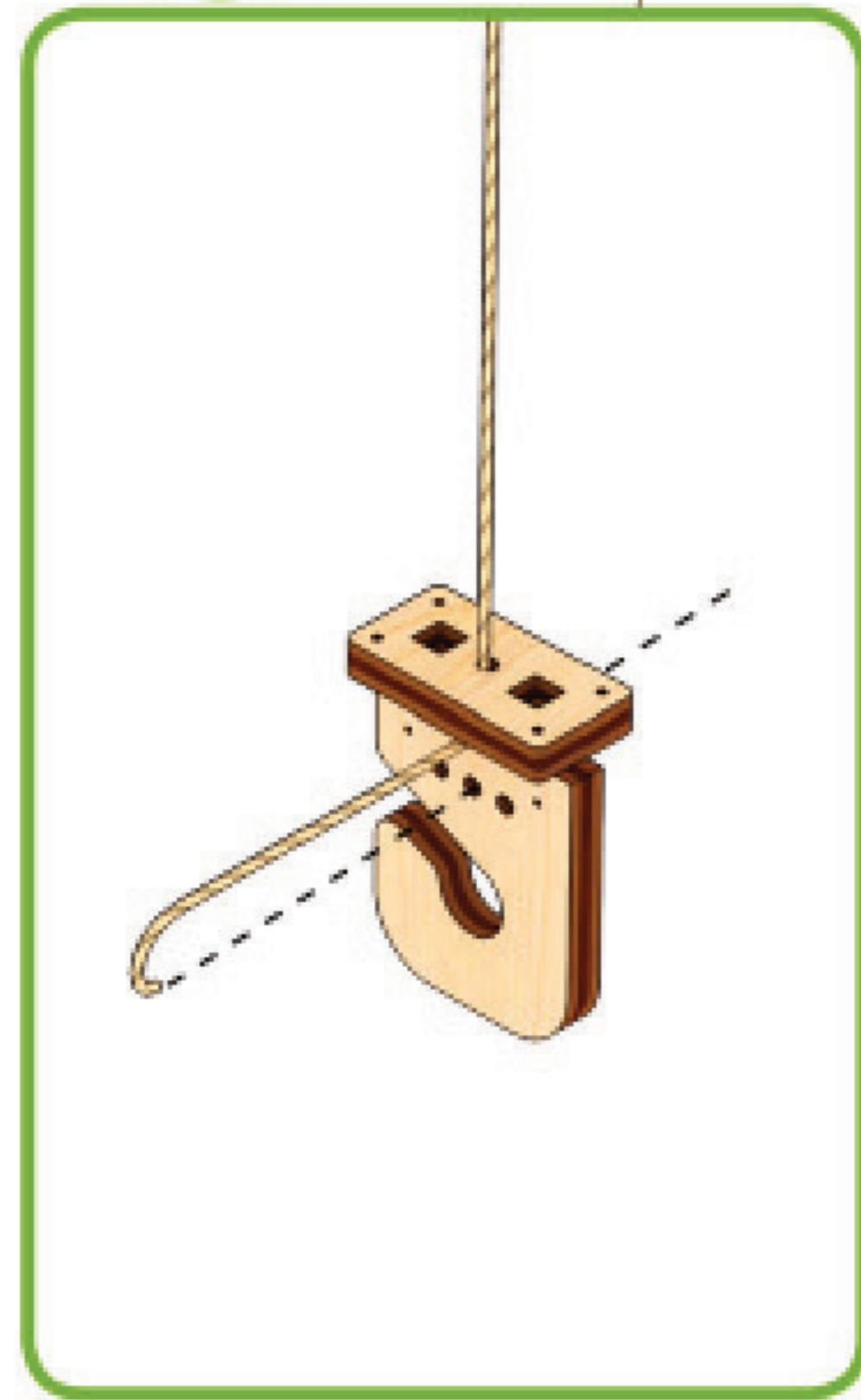

15

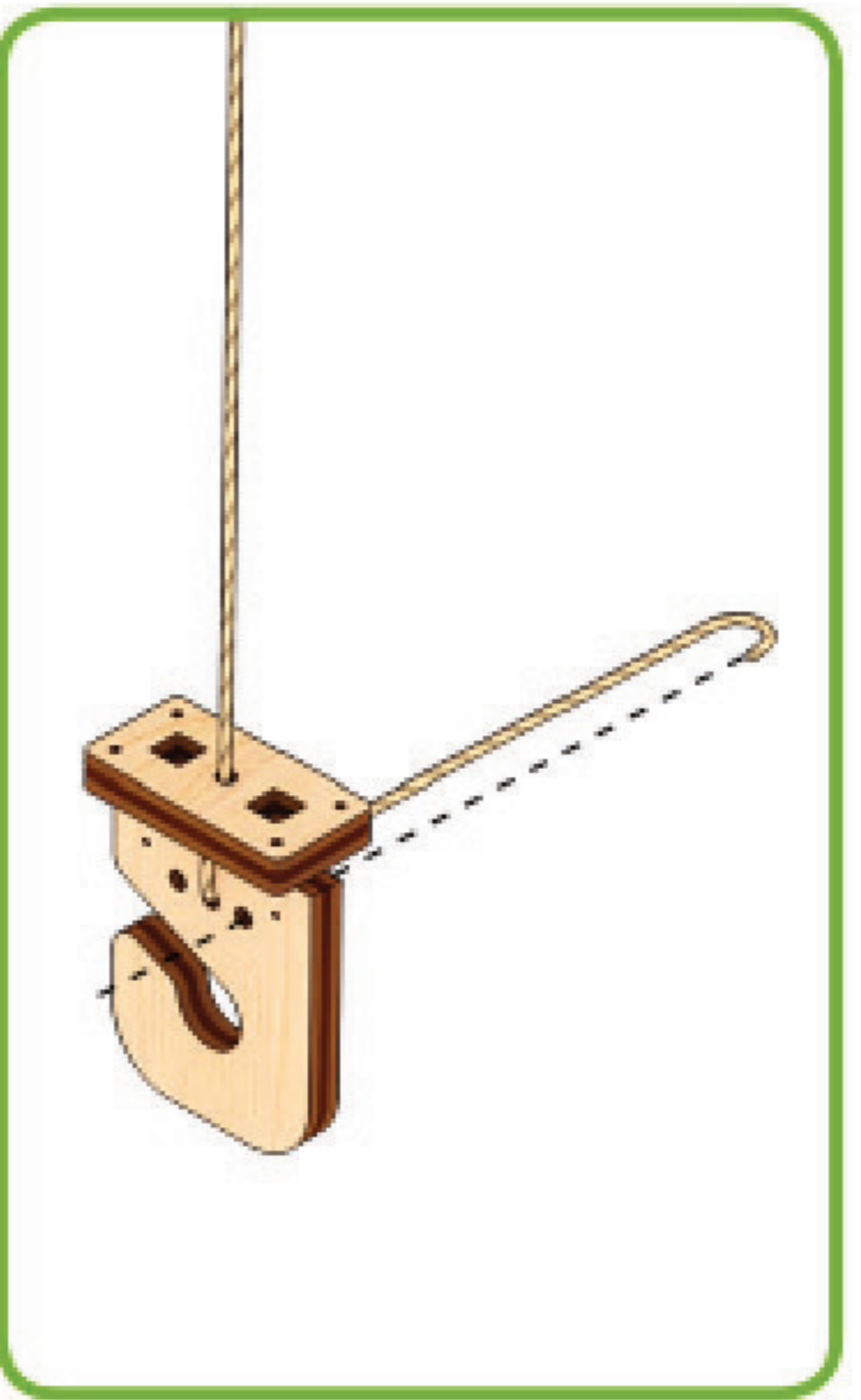

16

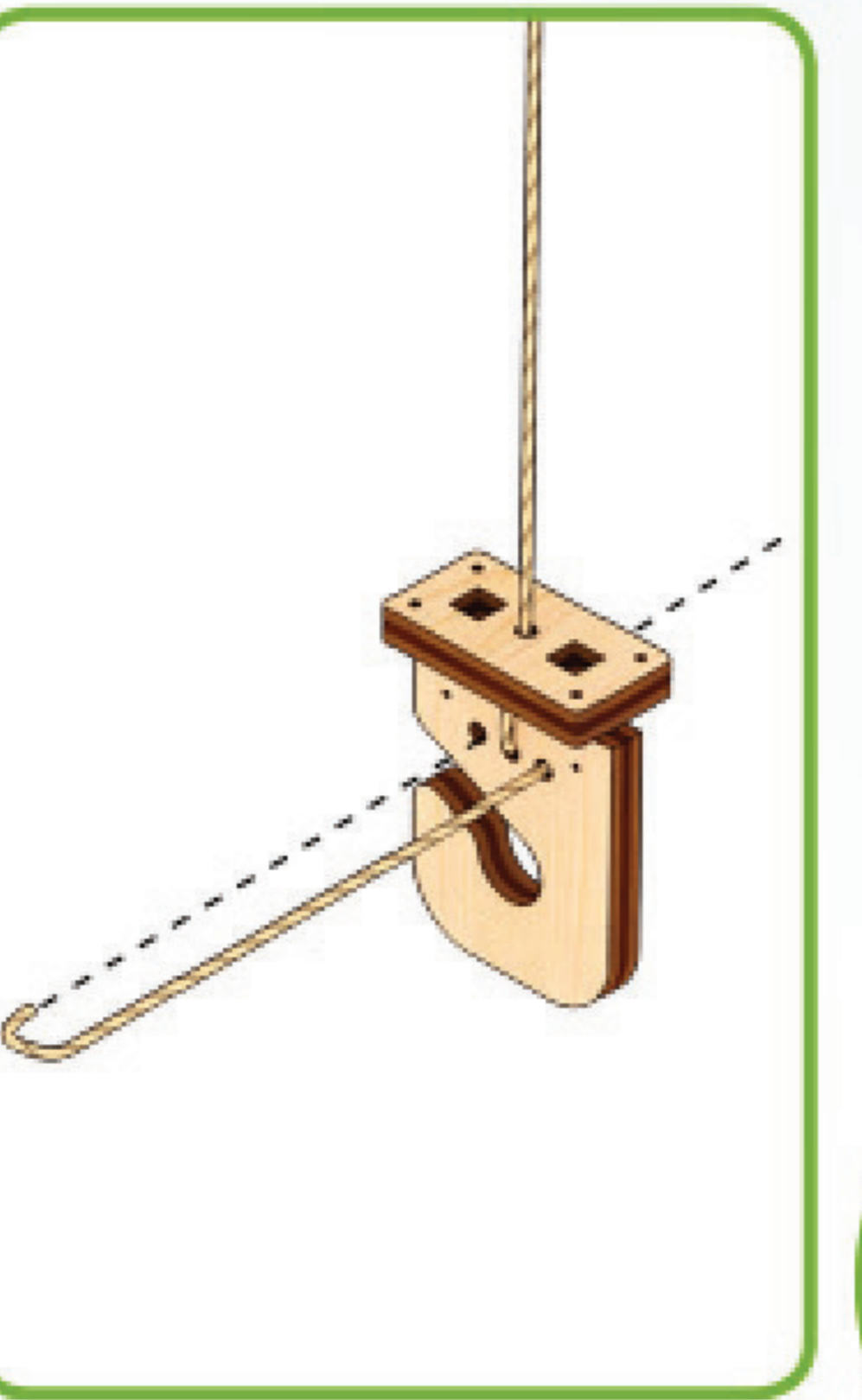

17

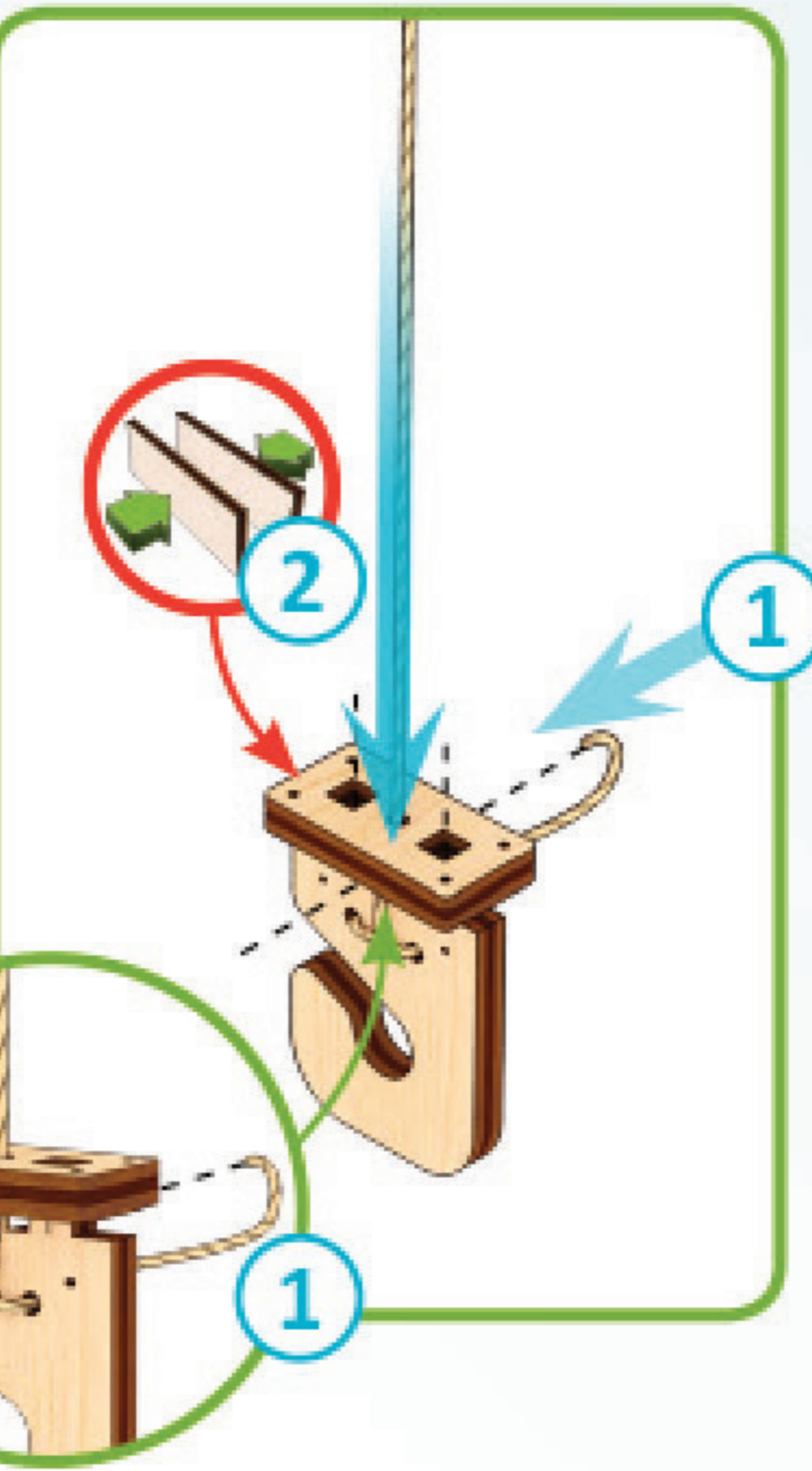

18

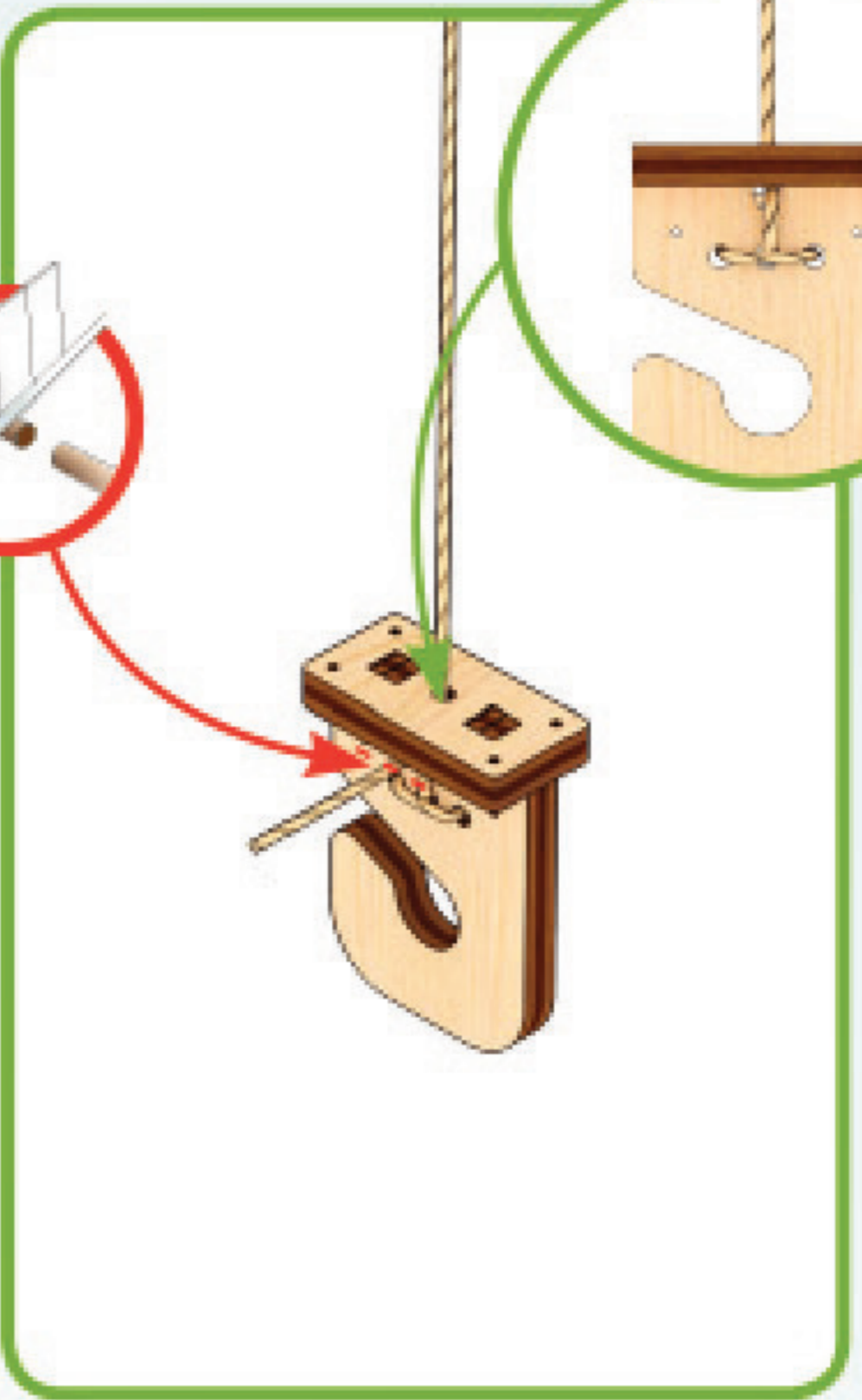

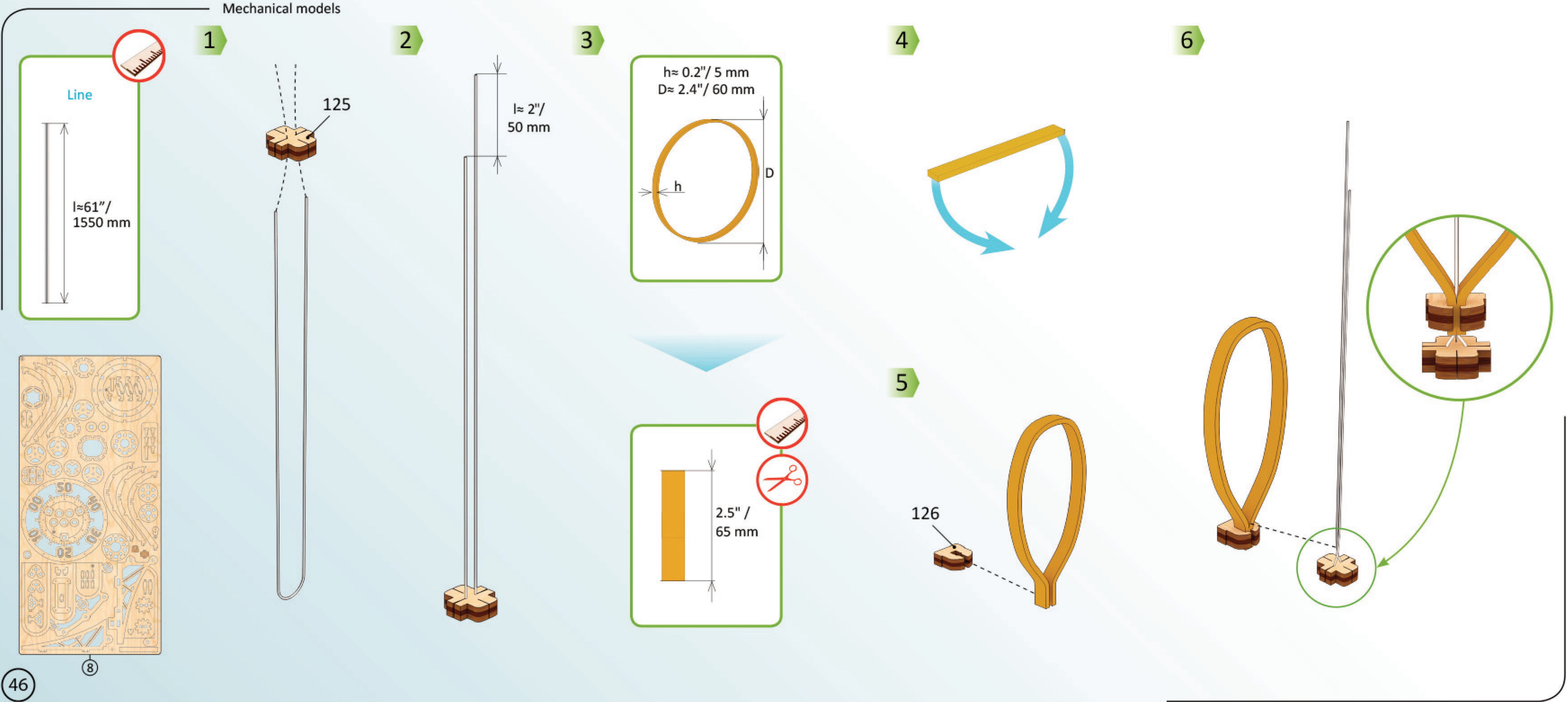

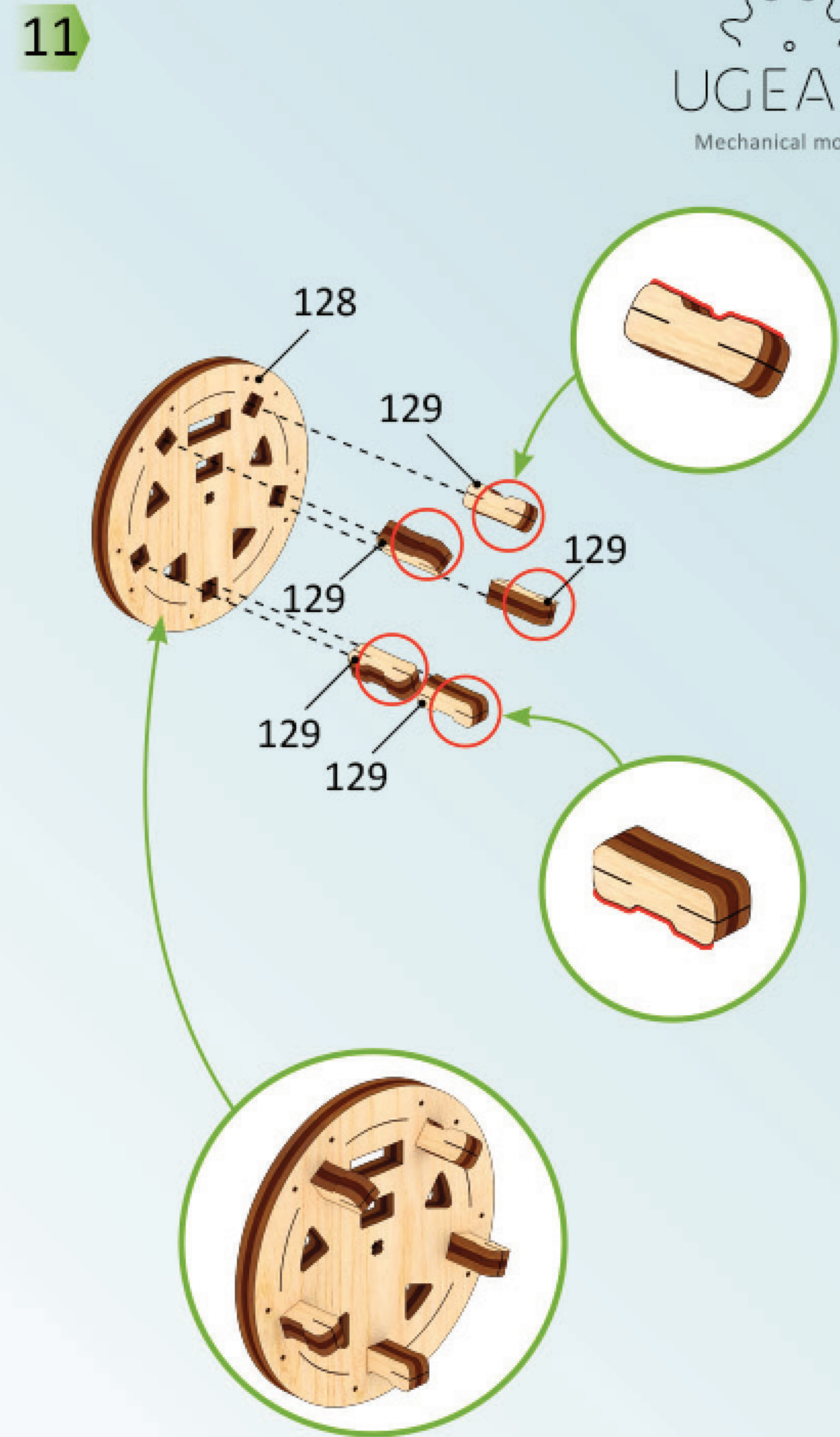
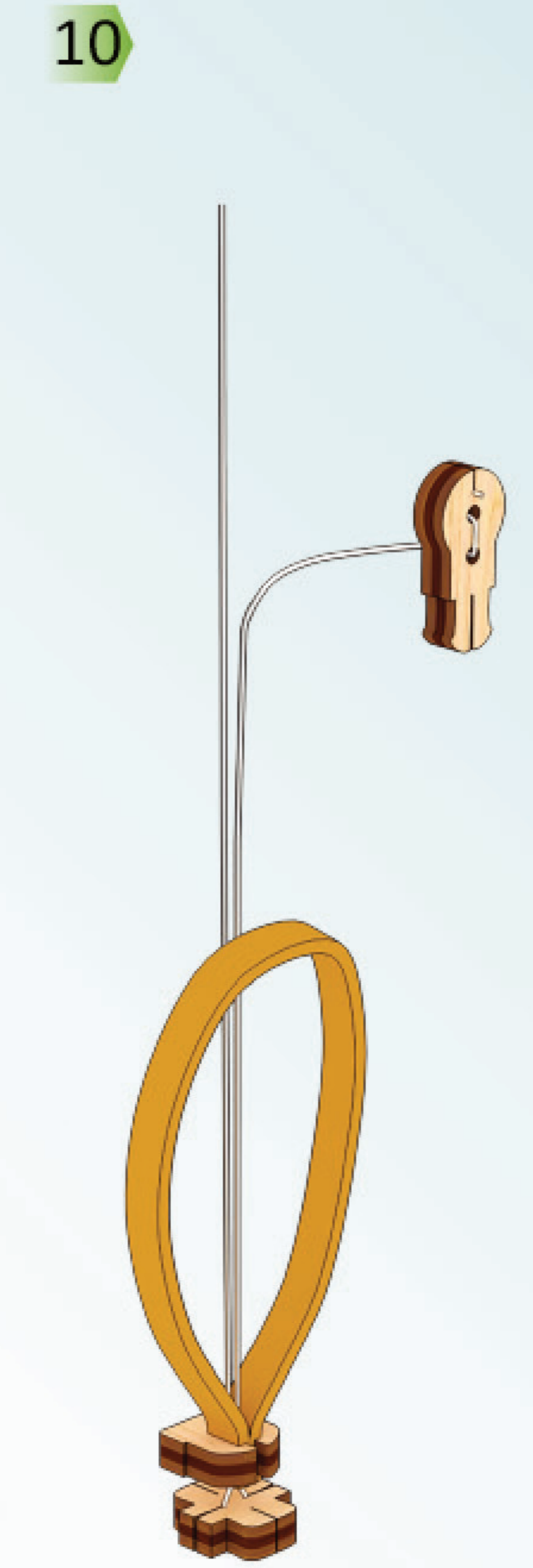
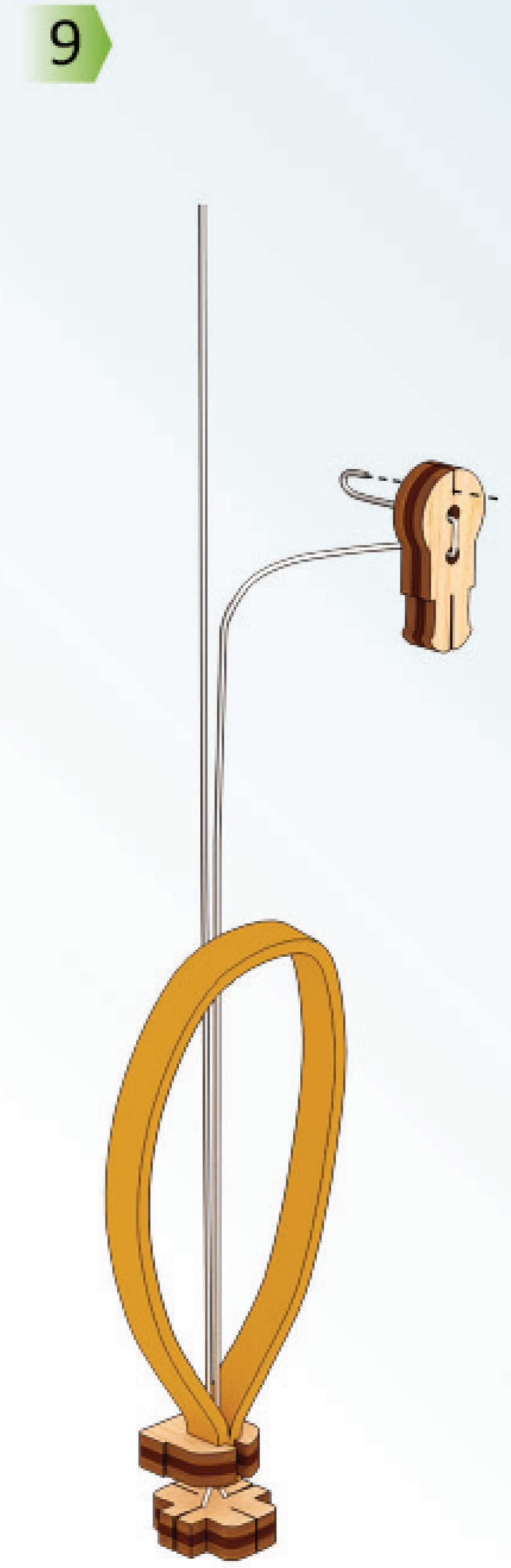
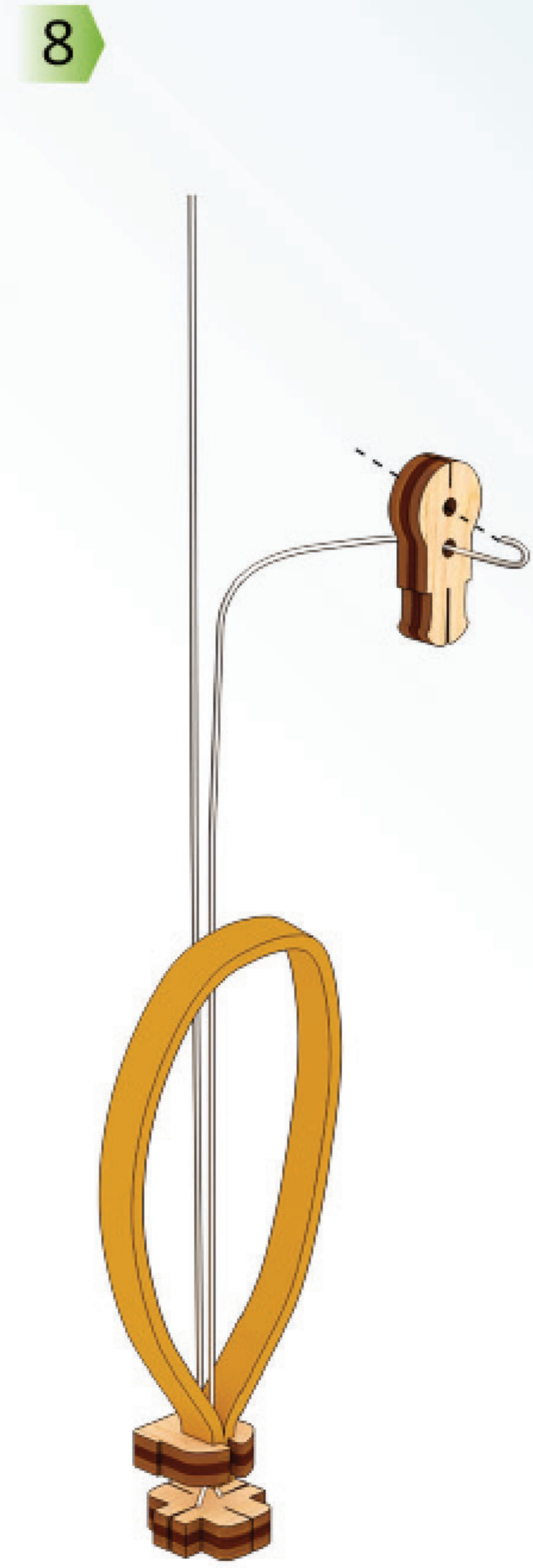
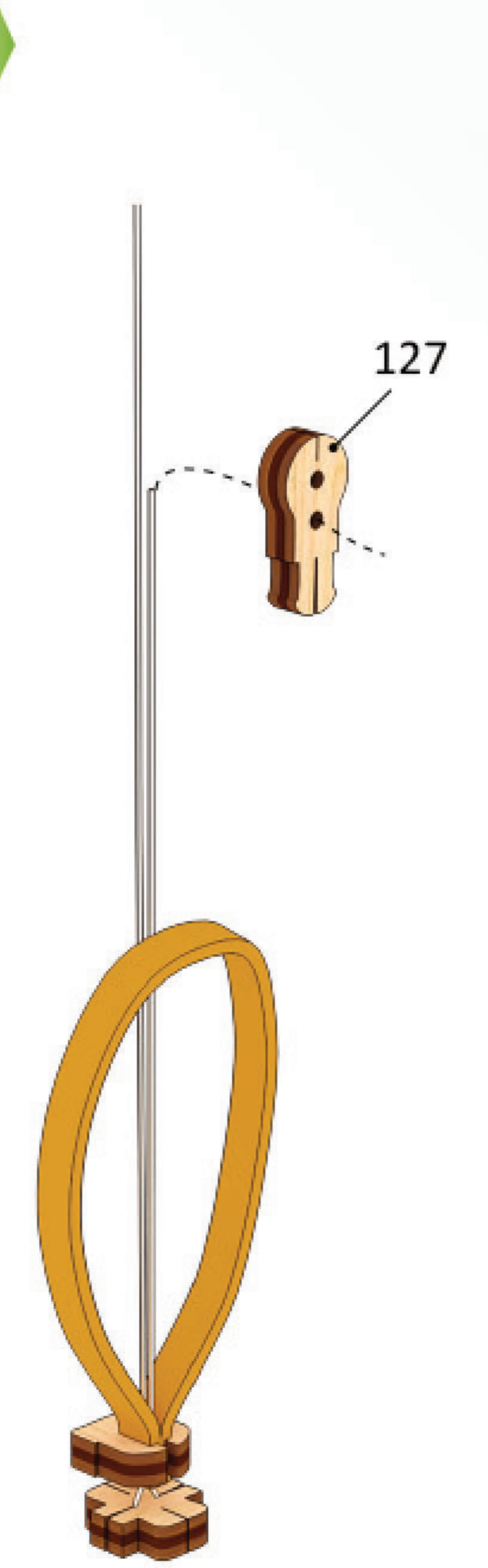
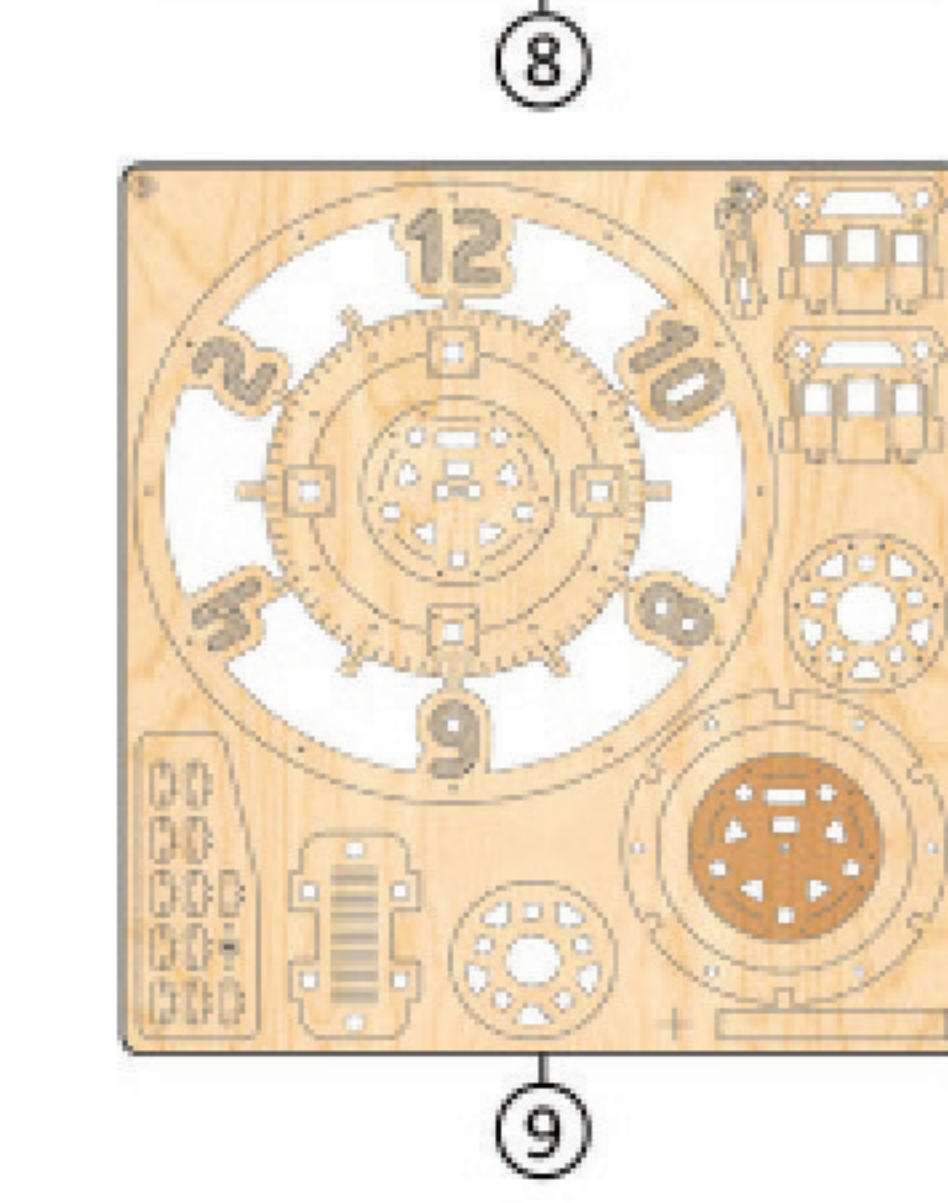
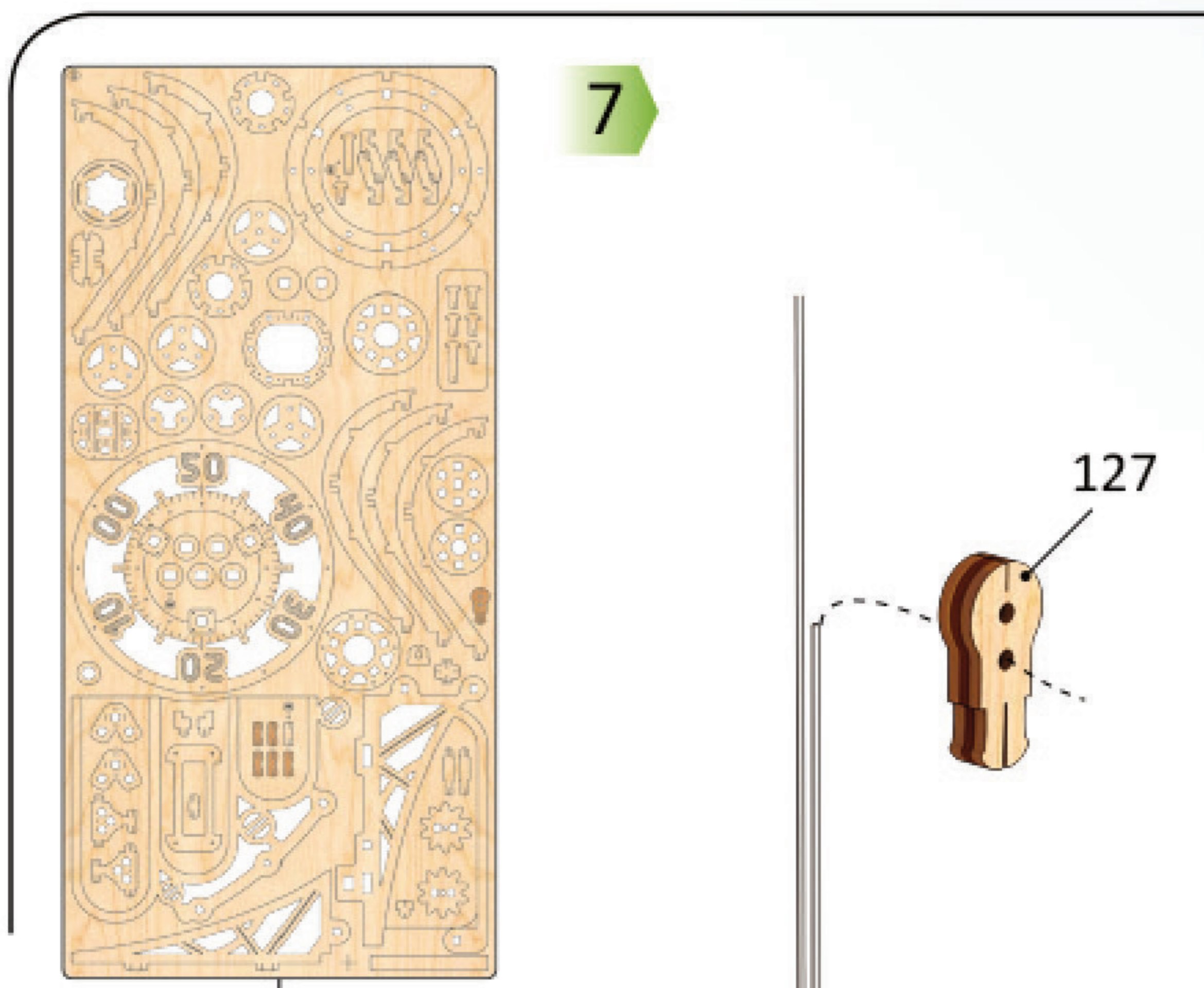

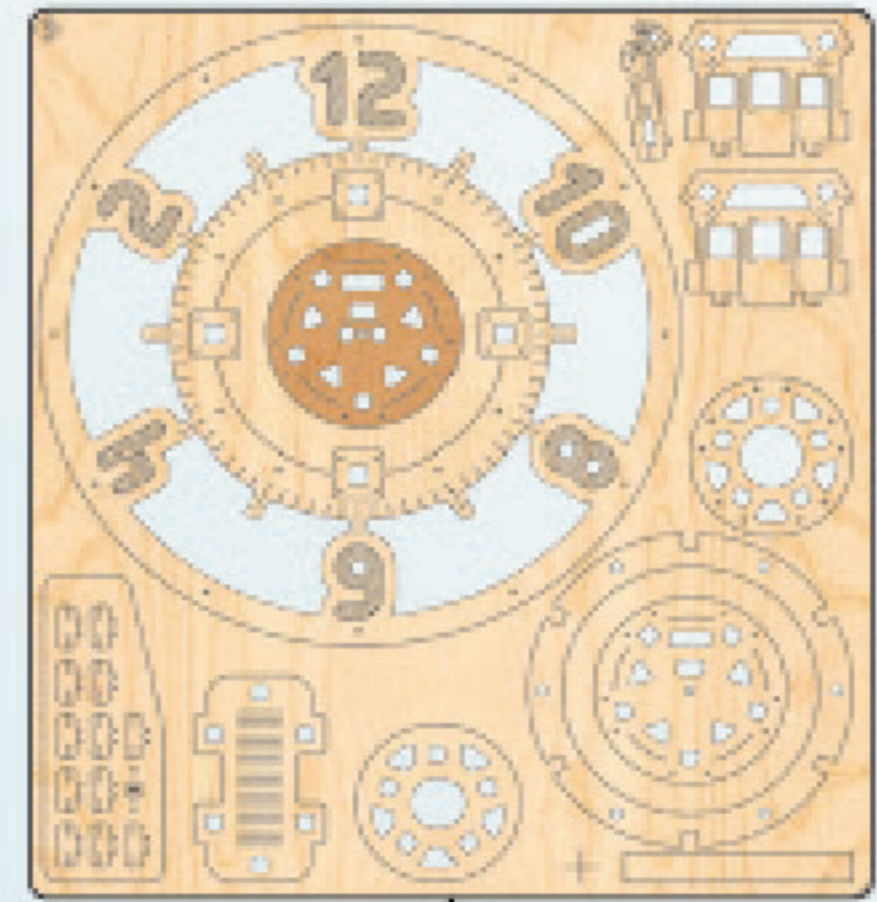
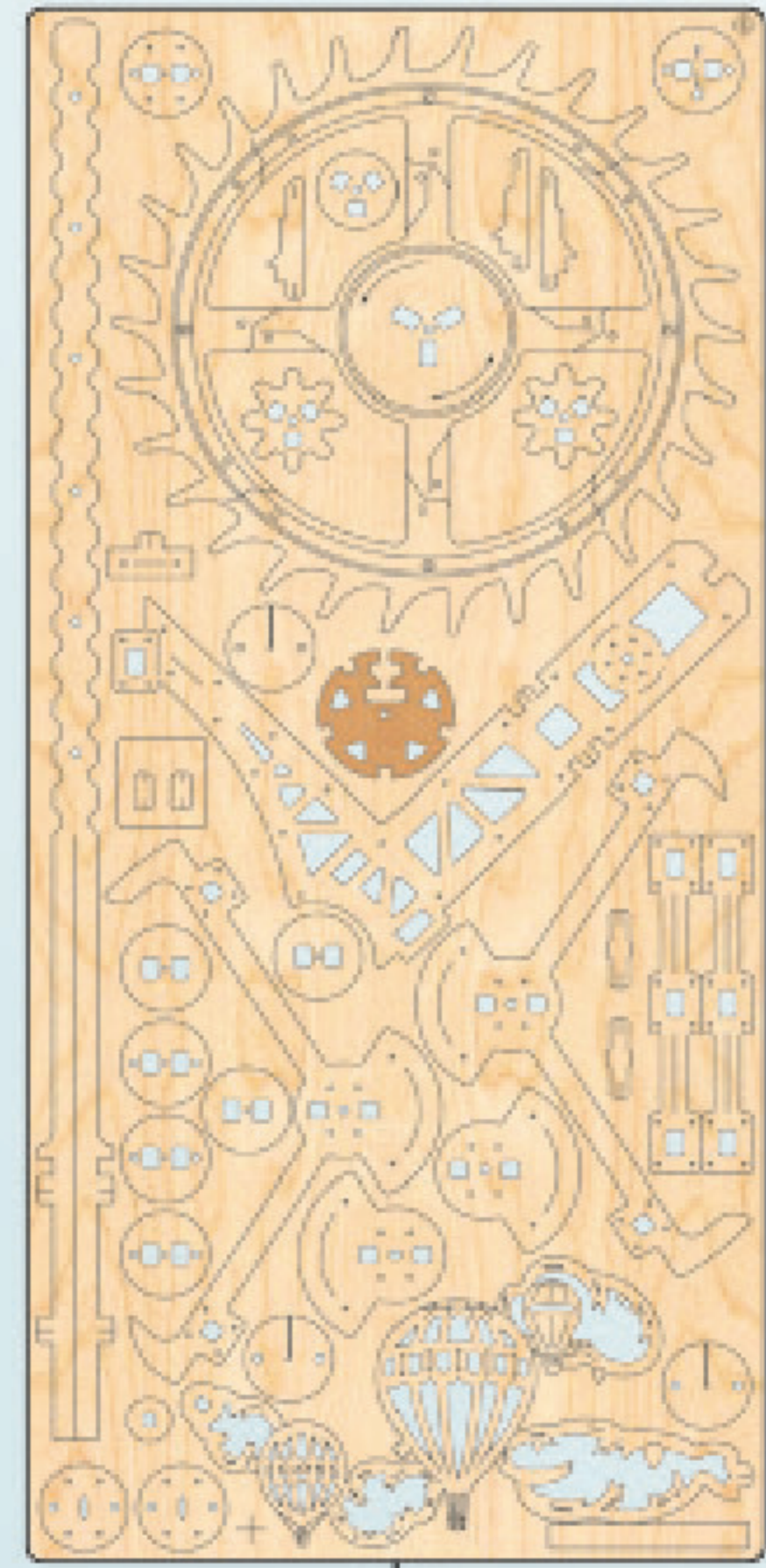

12

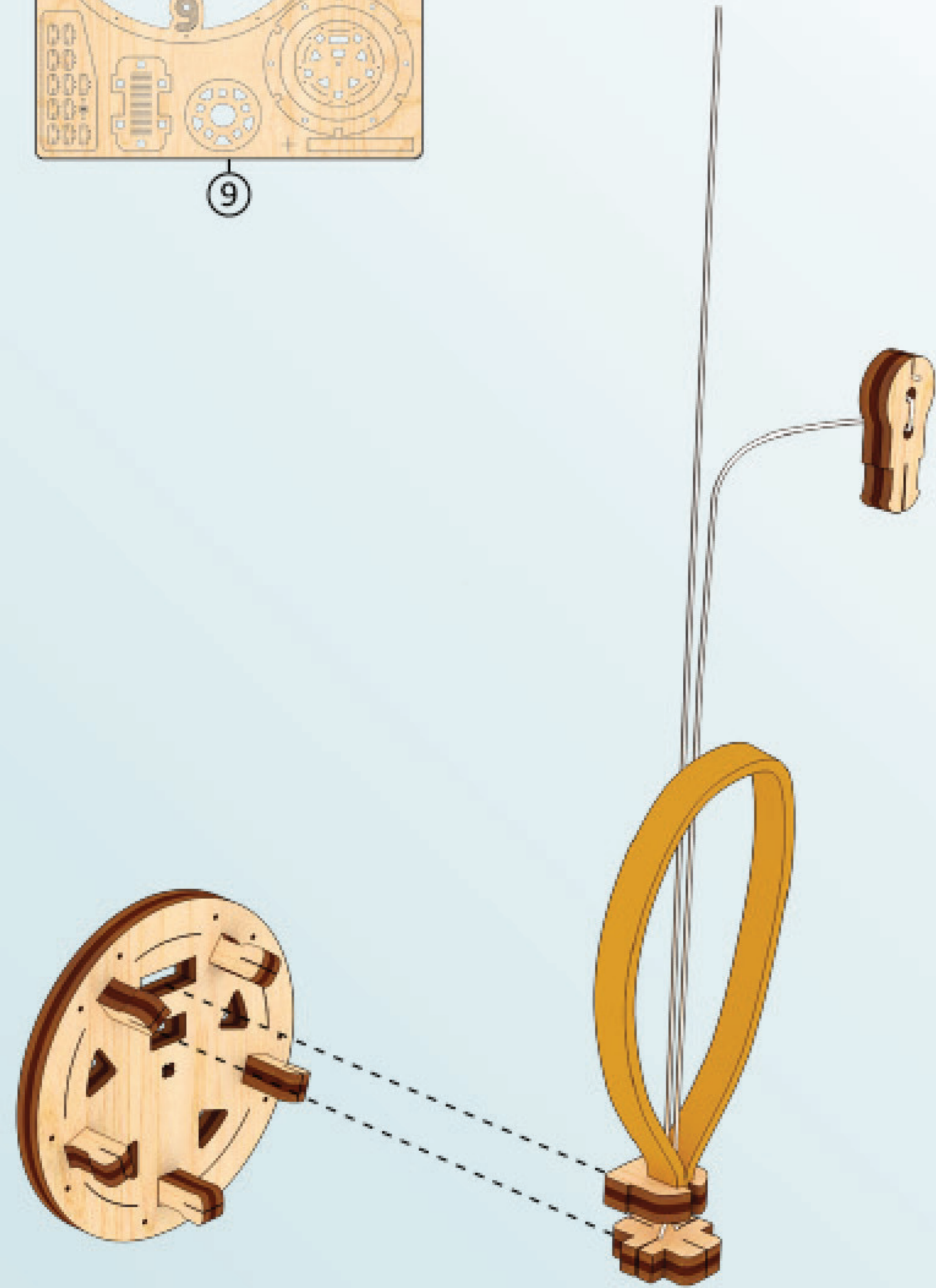

13

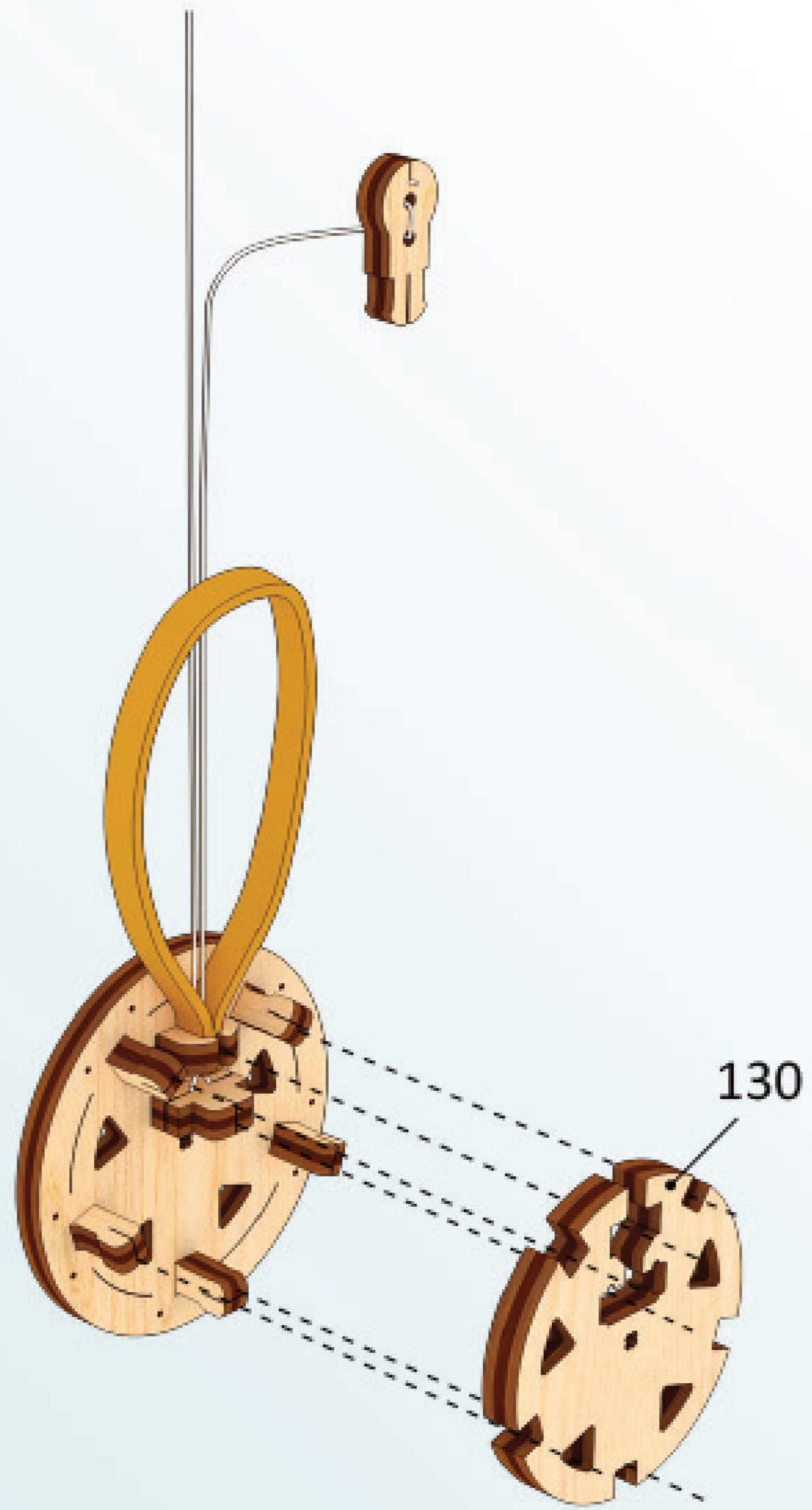

14

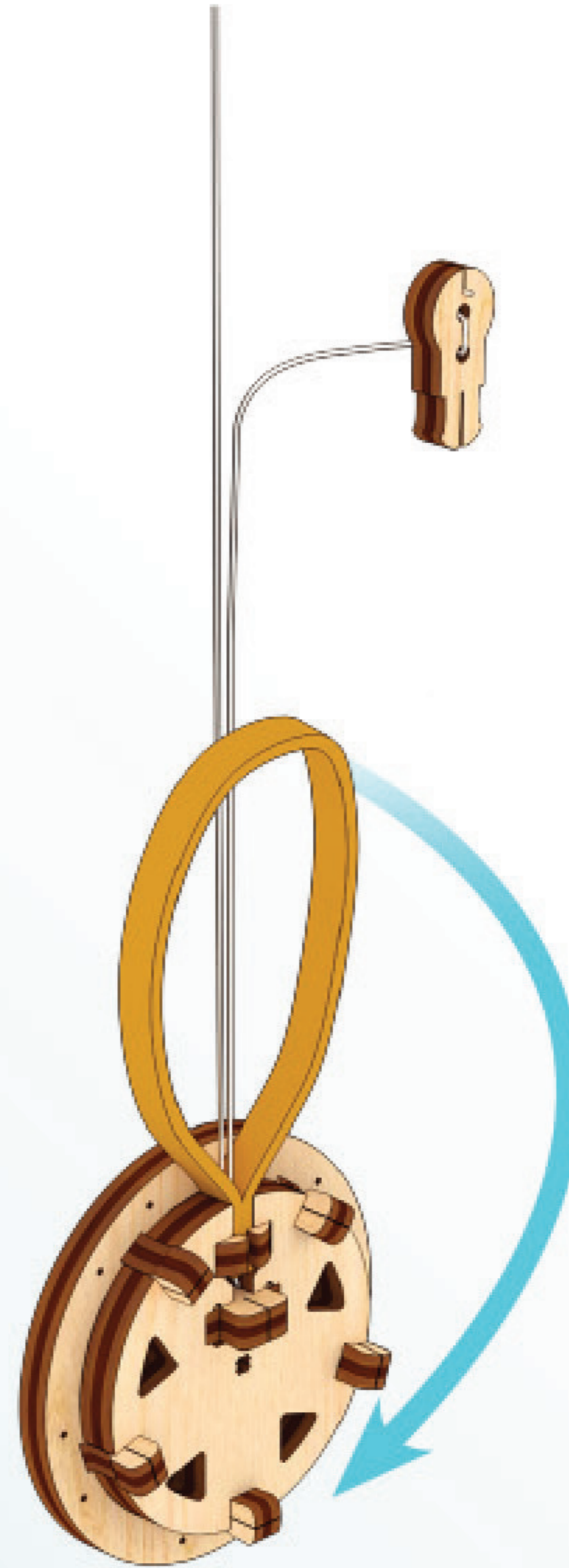

15

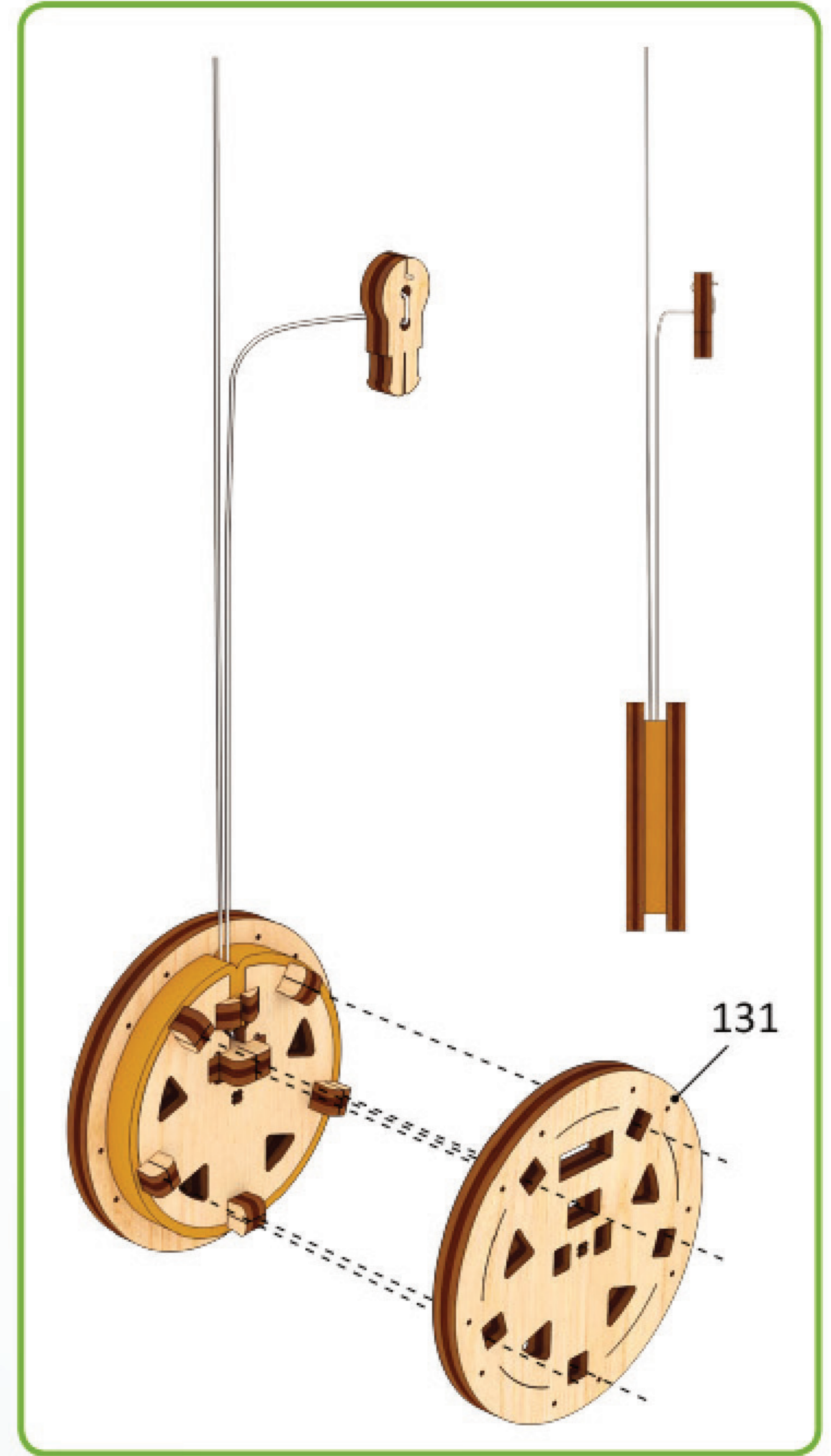



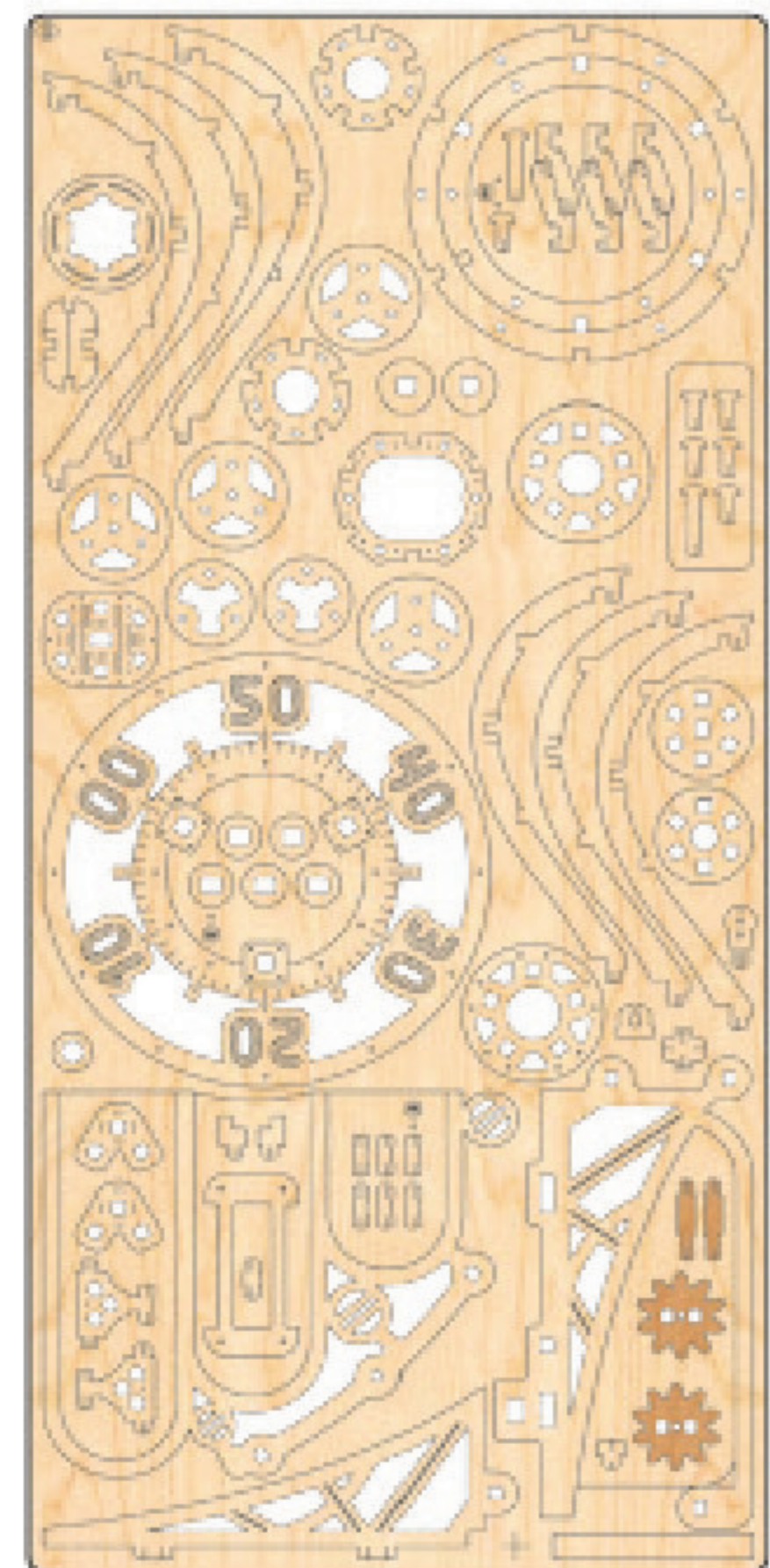

16



17

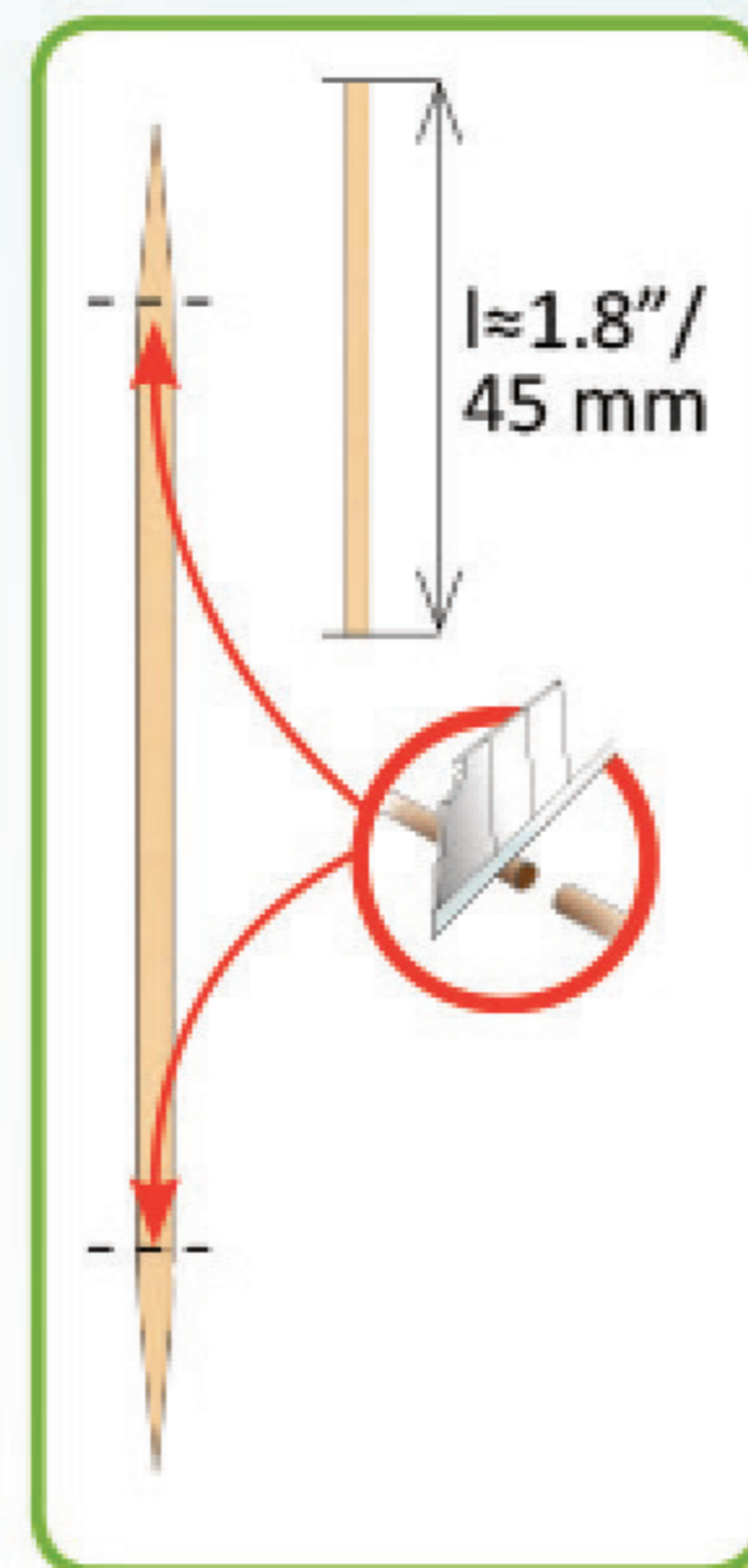
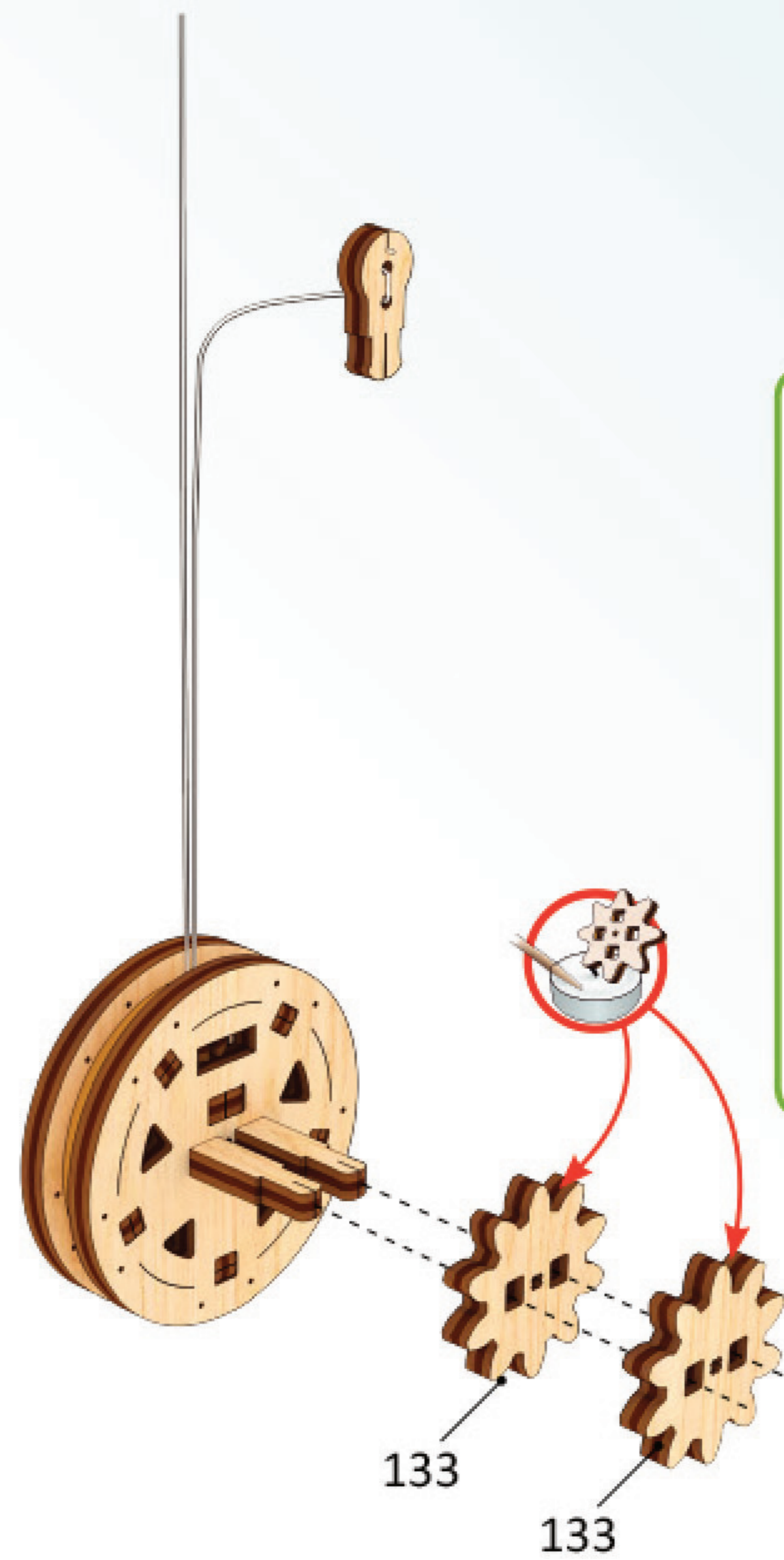

18

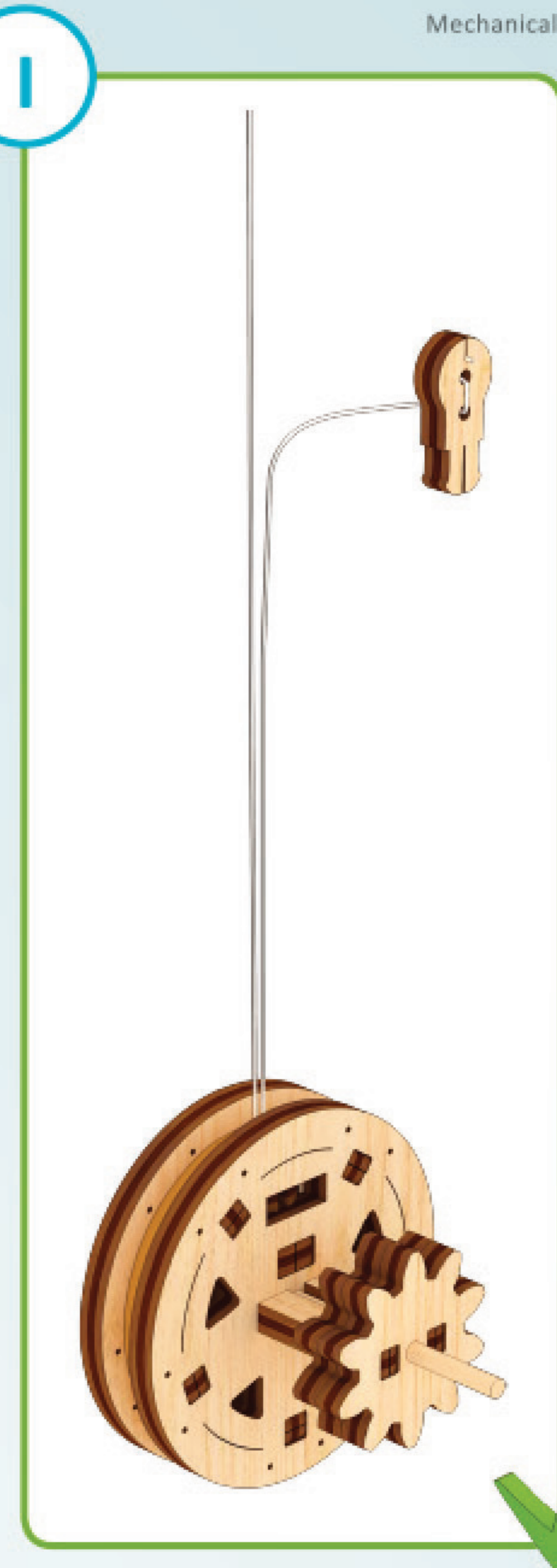
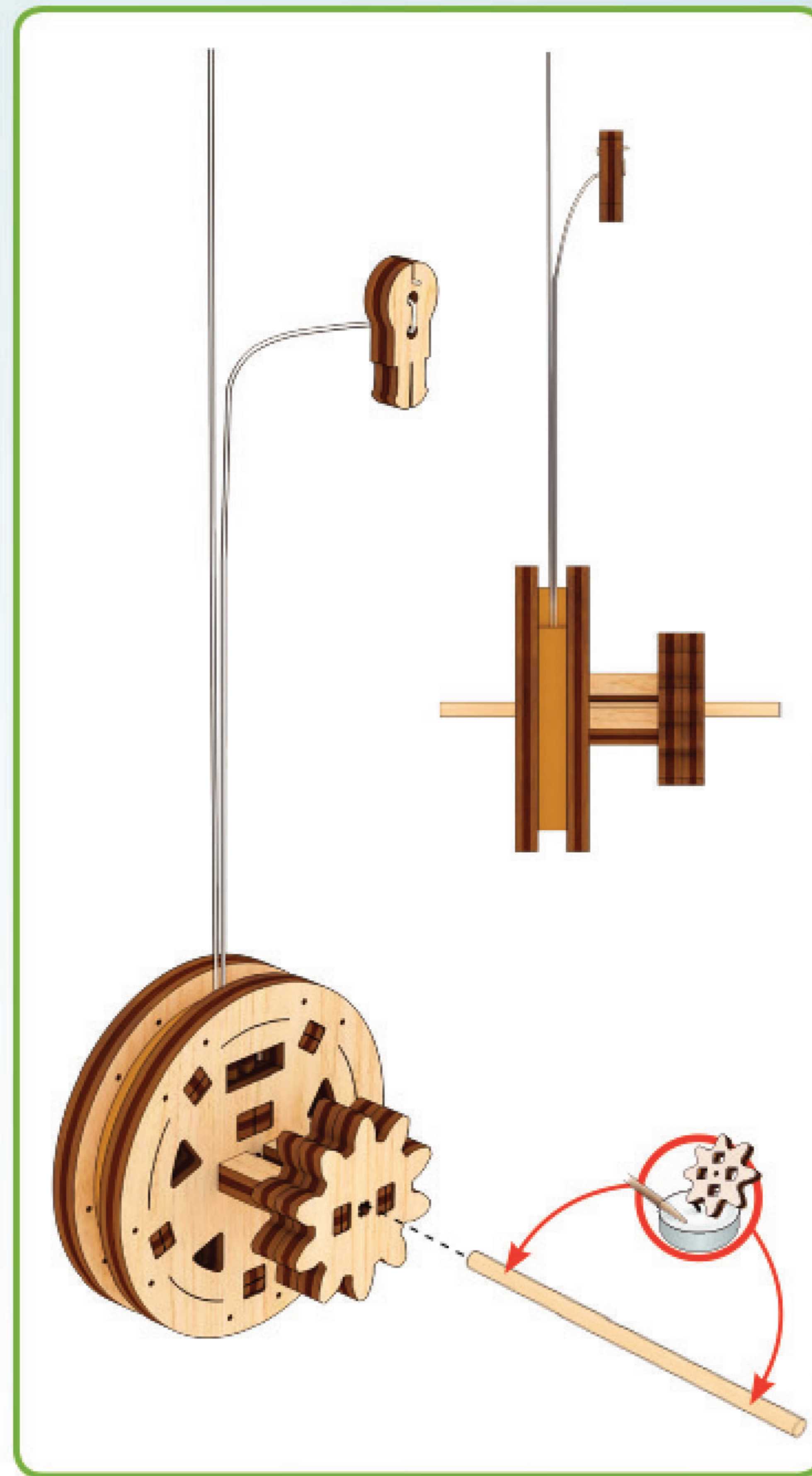

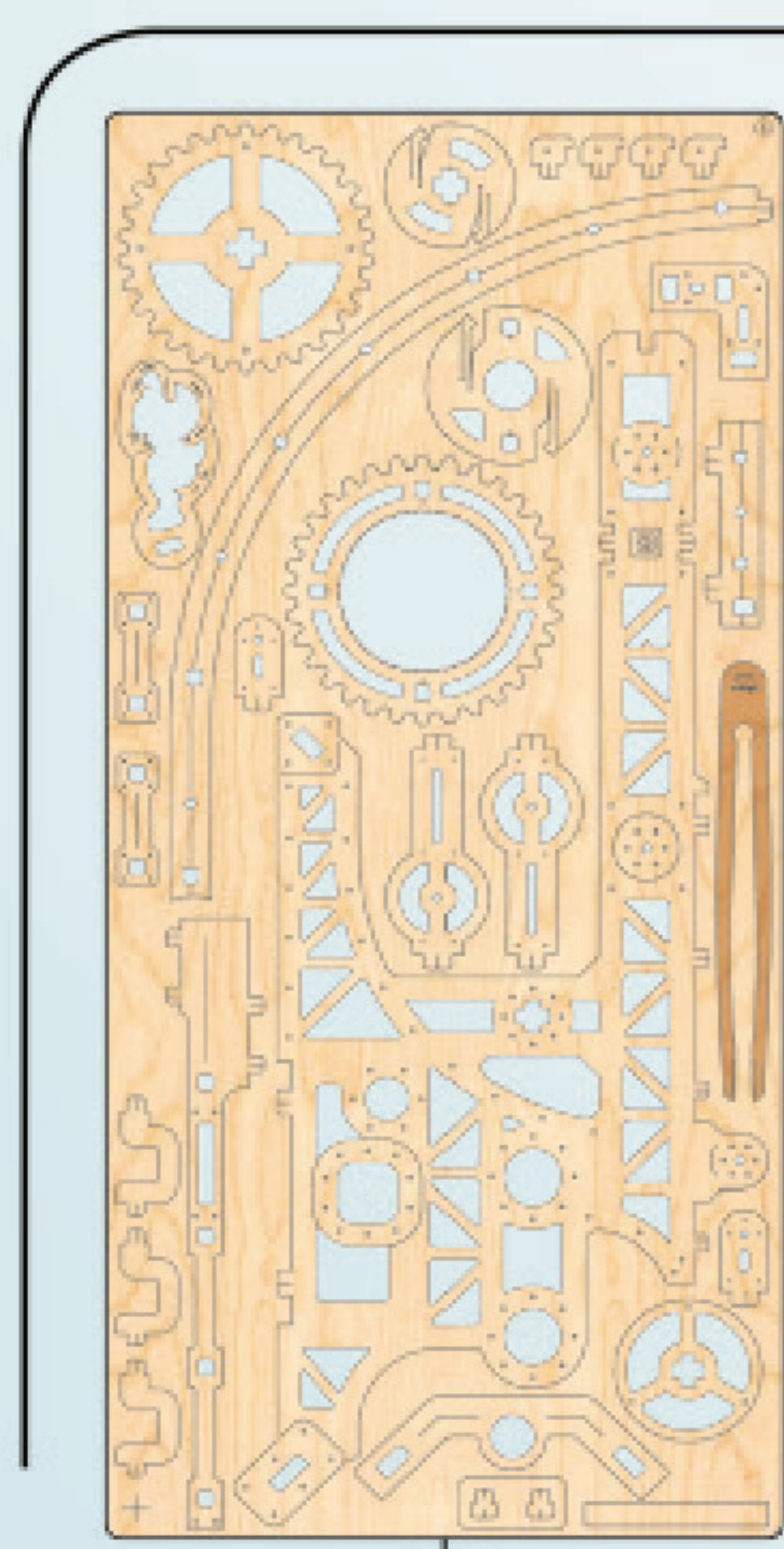

1

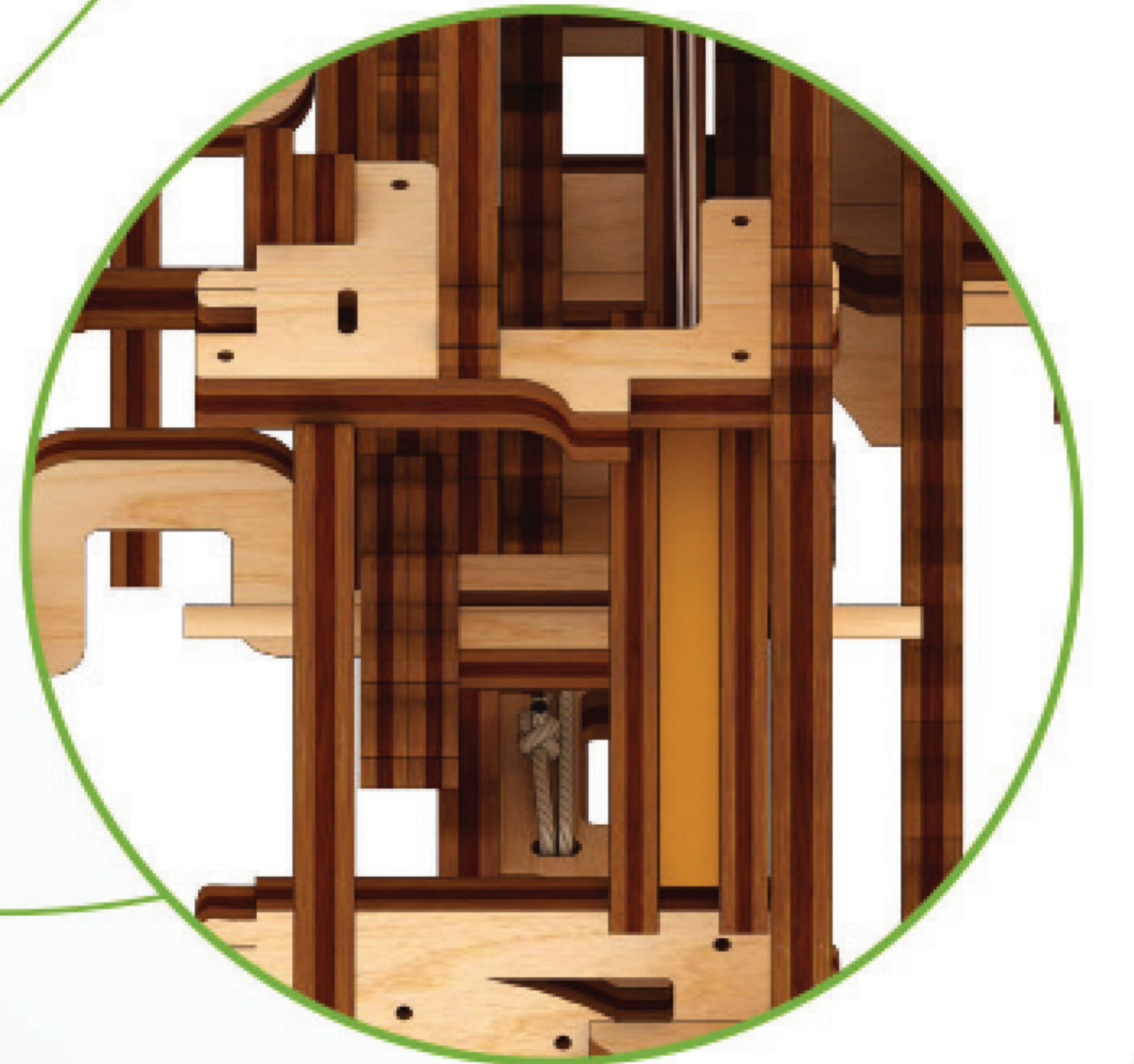
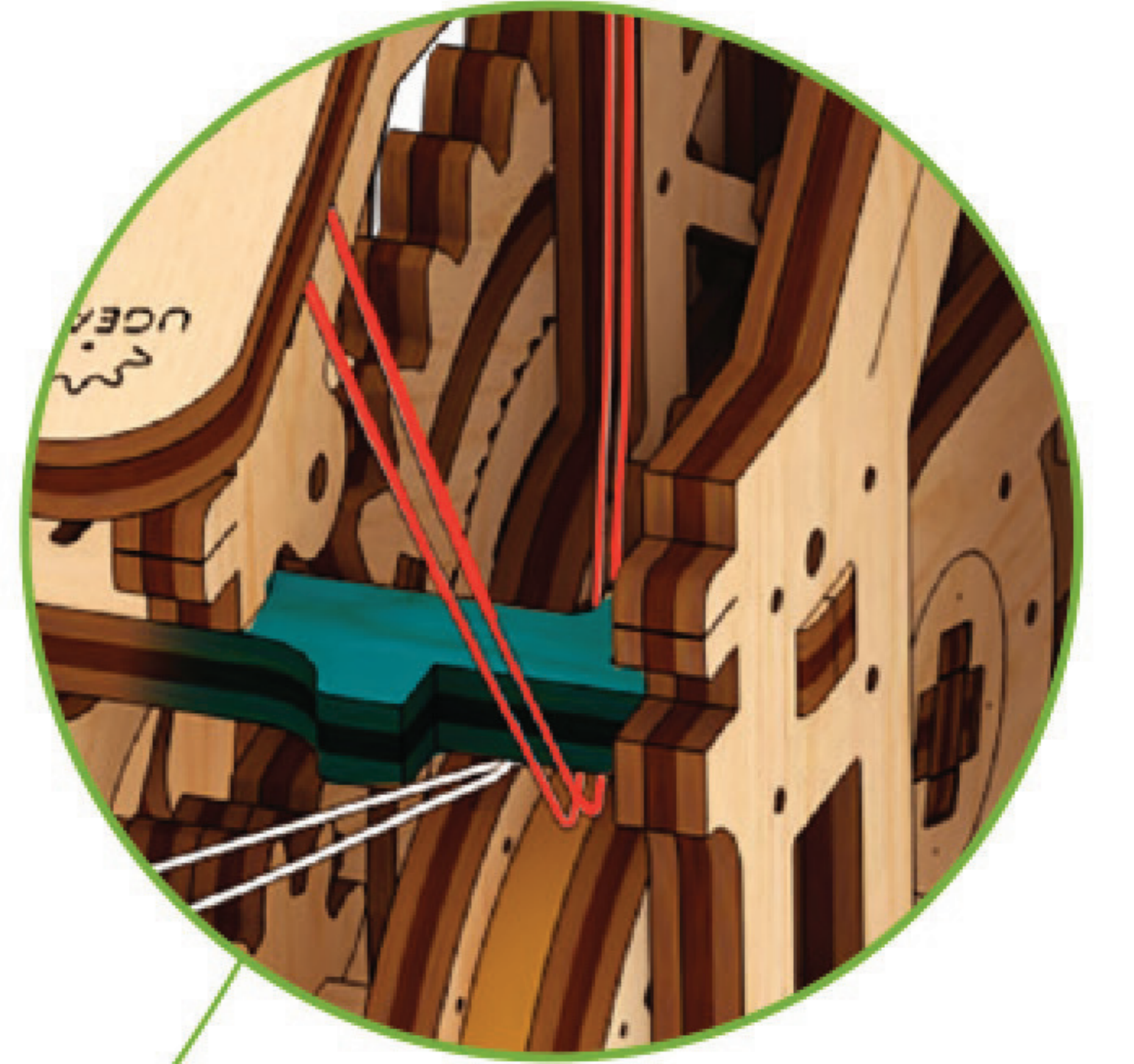
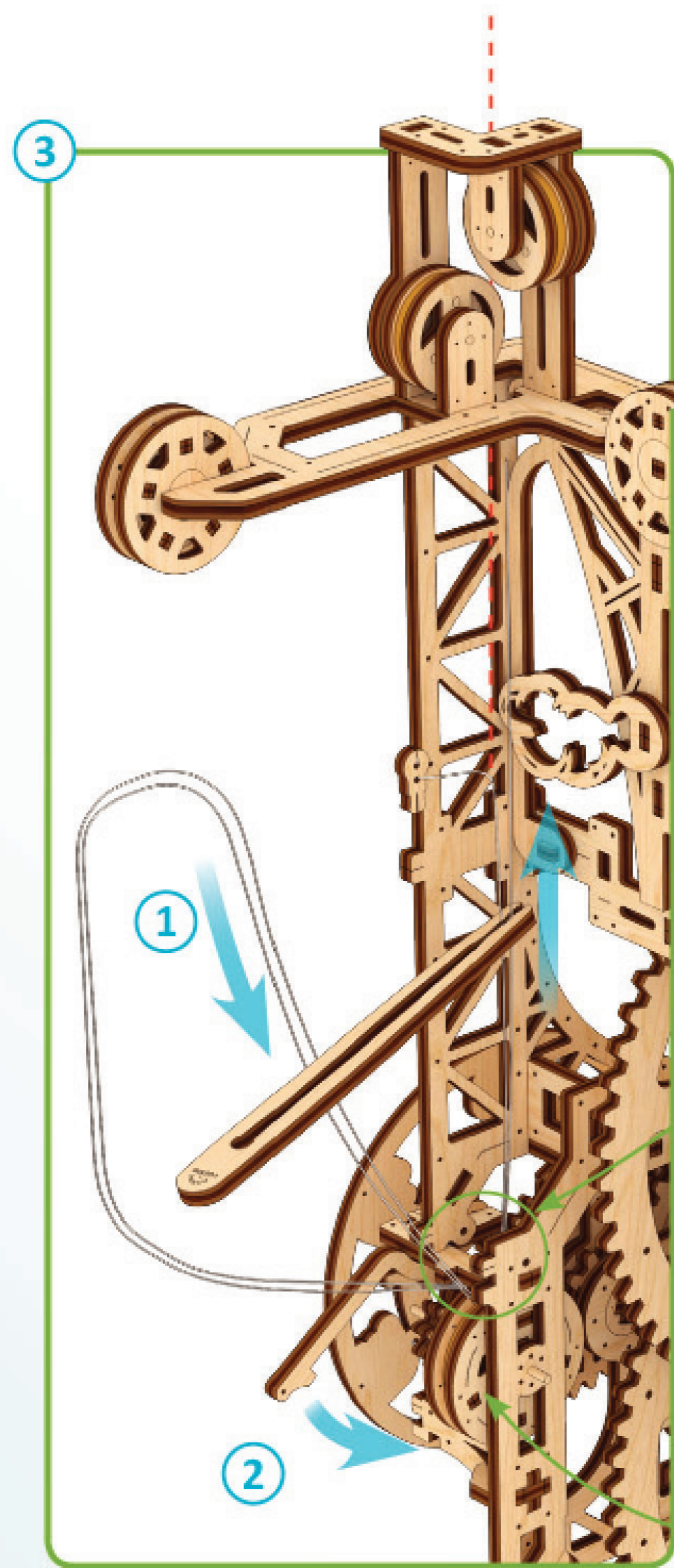
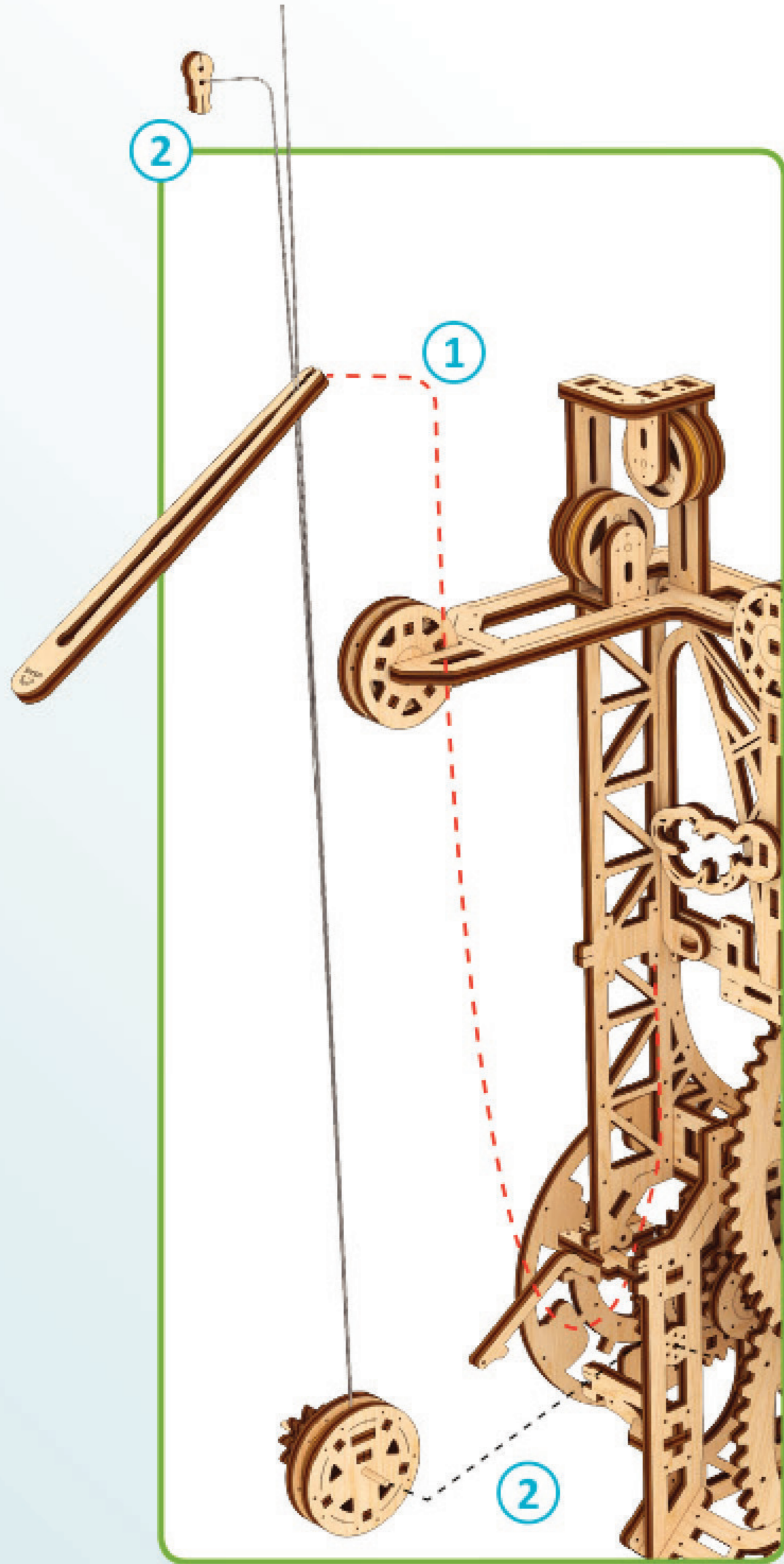
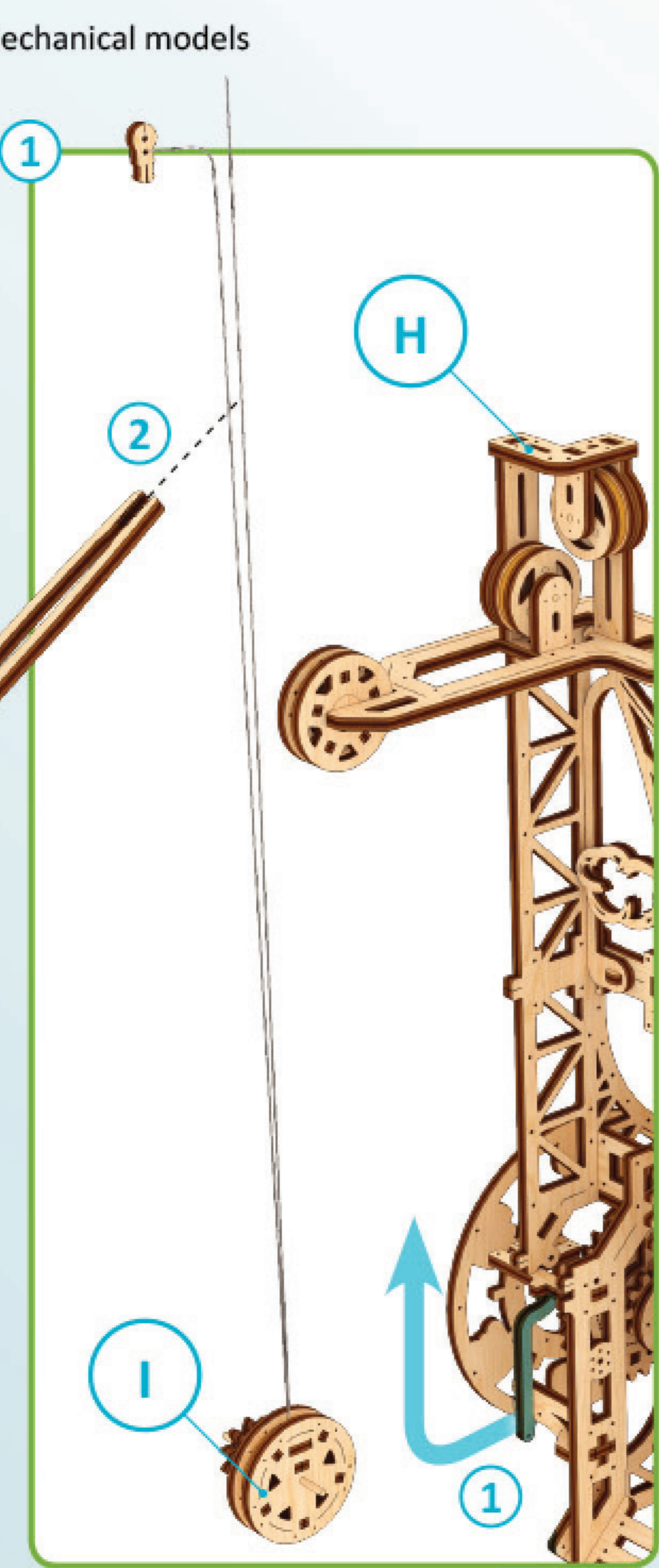

4

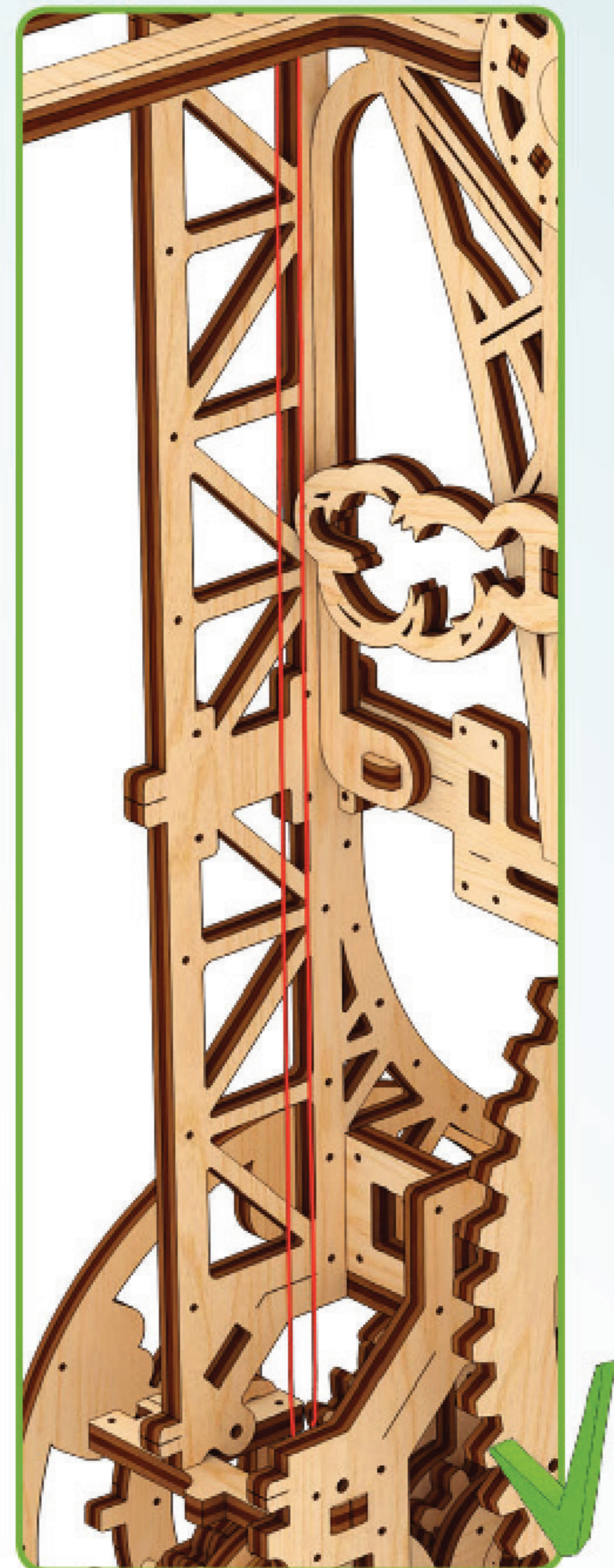
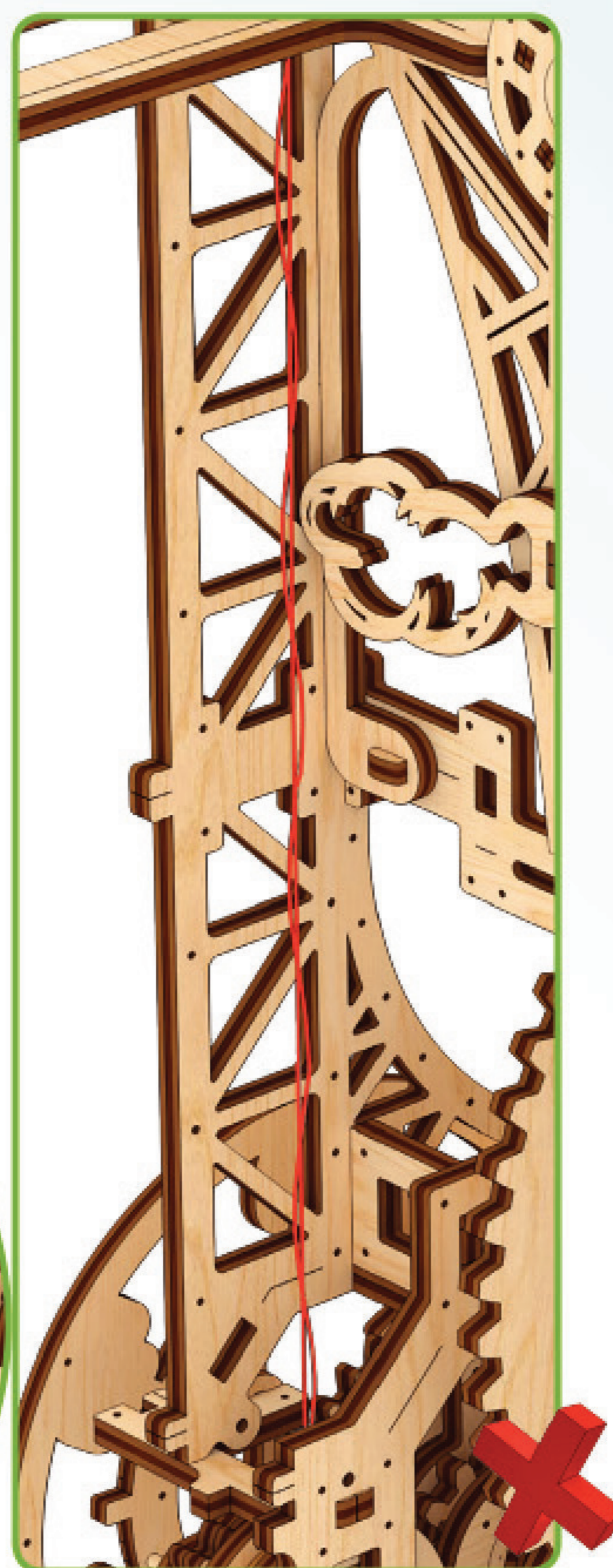
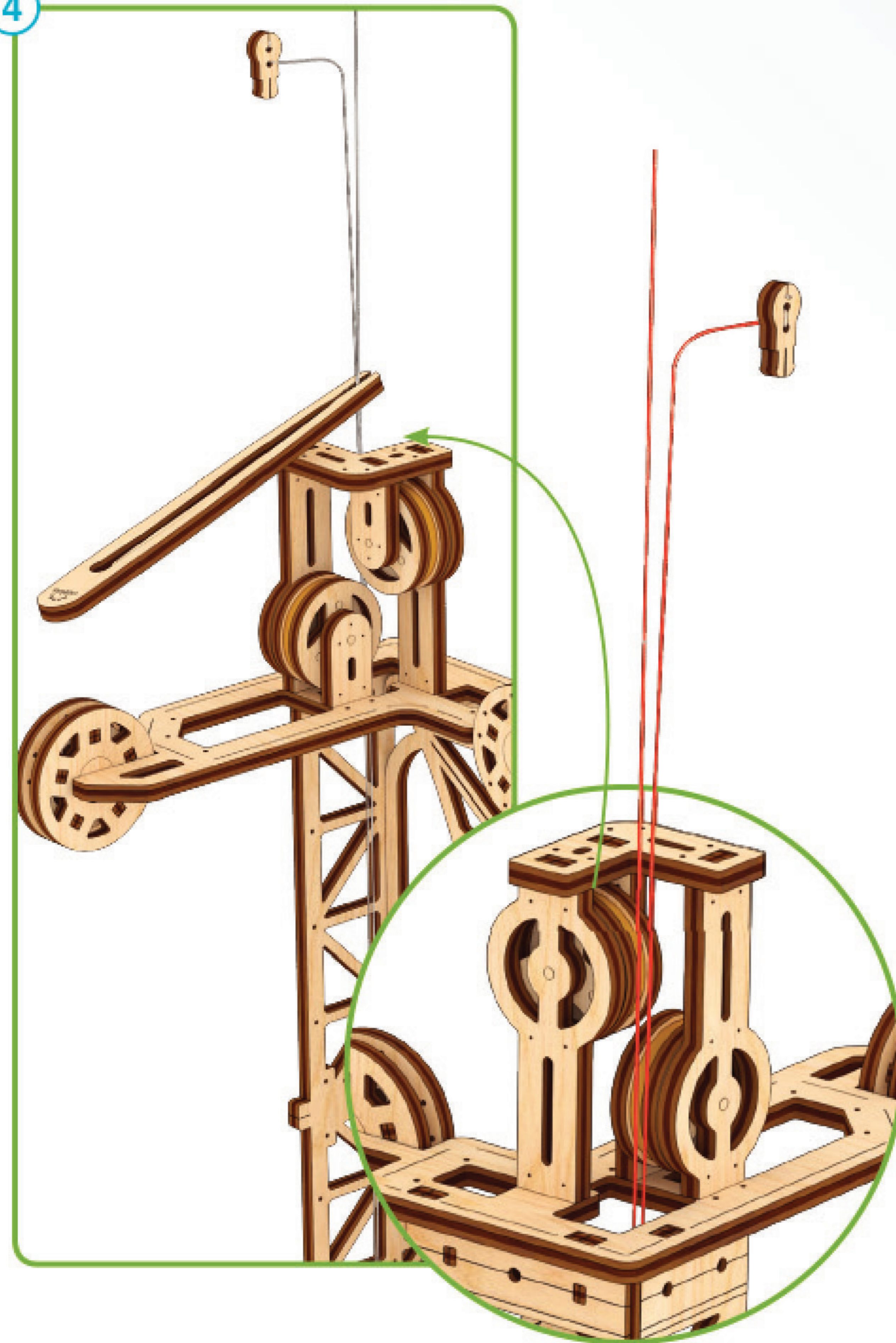

5

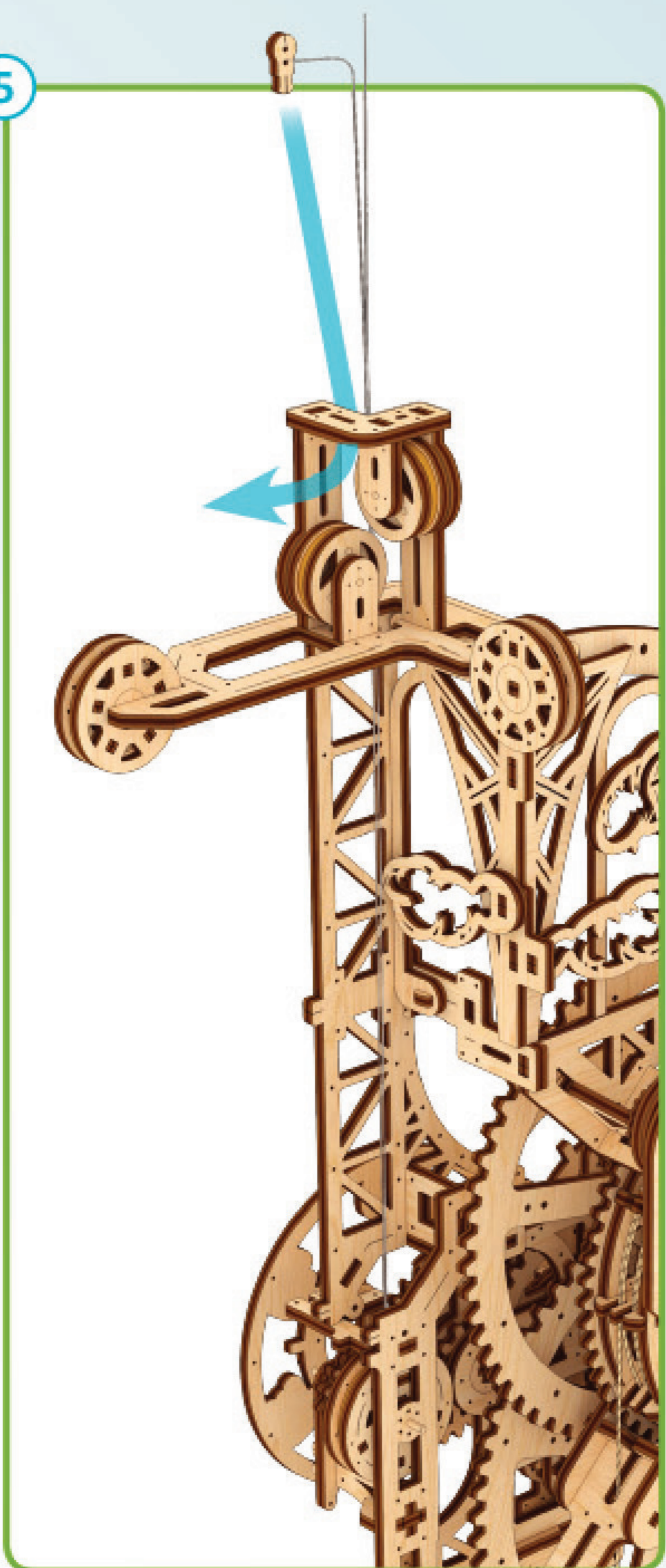

6

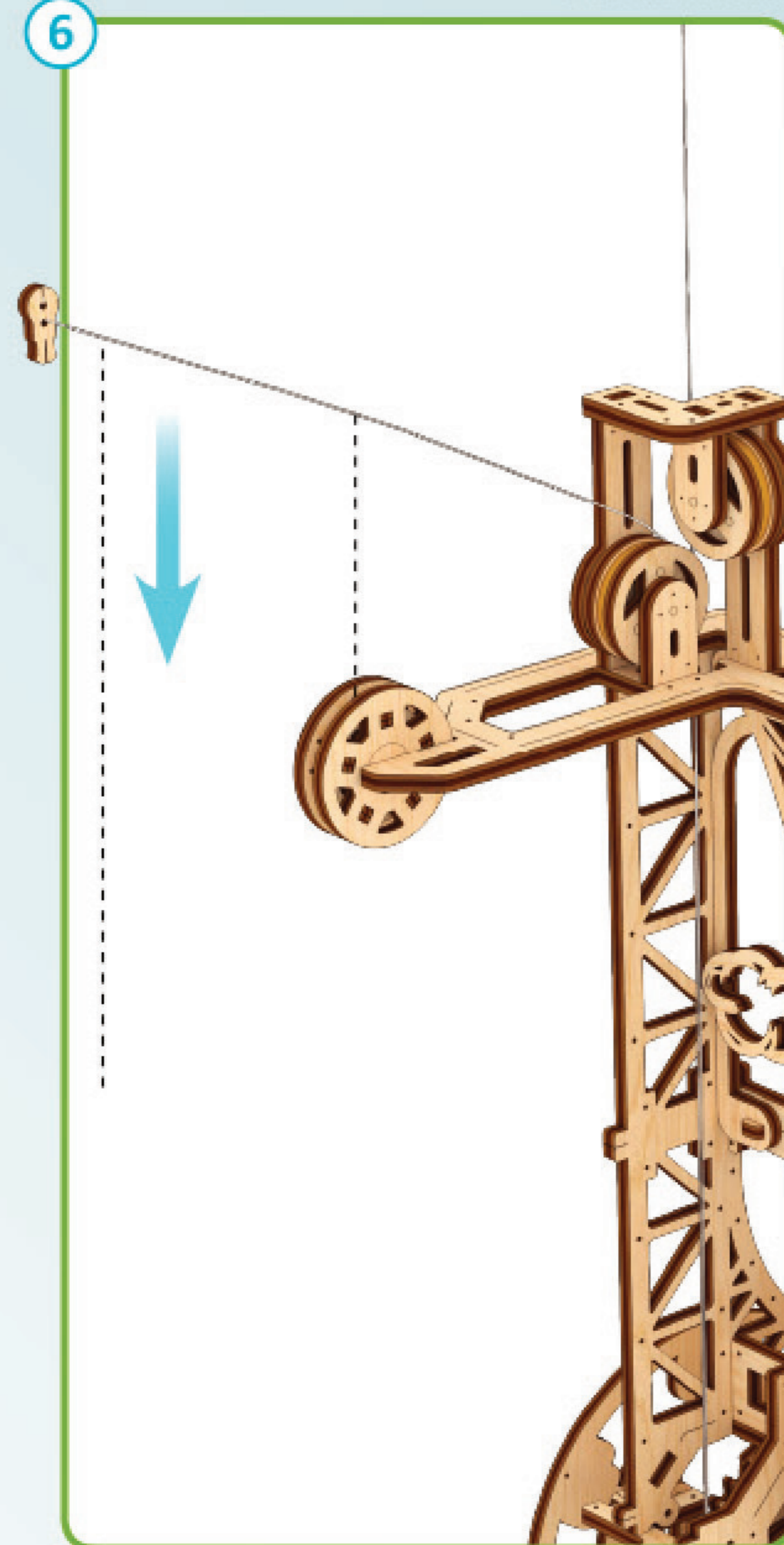

7

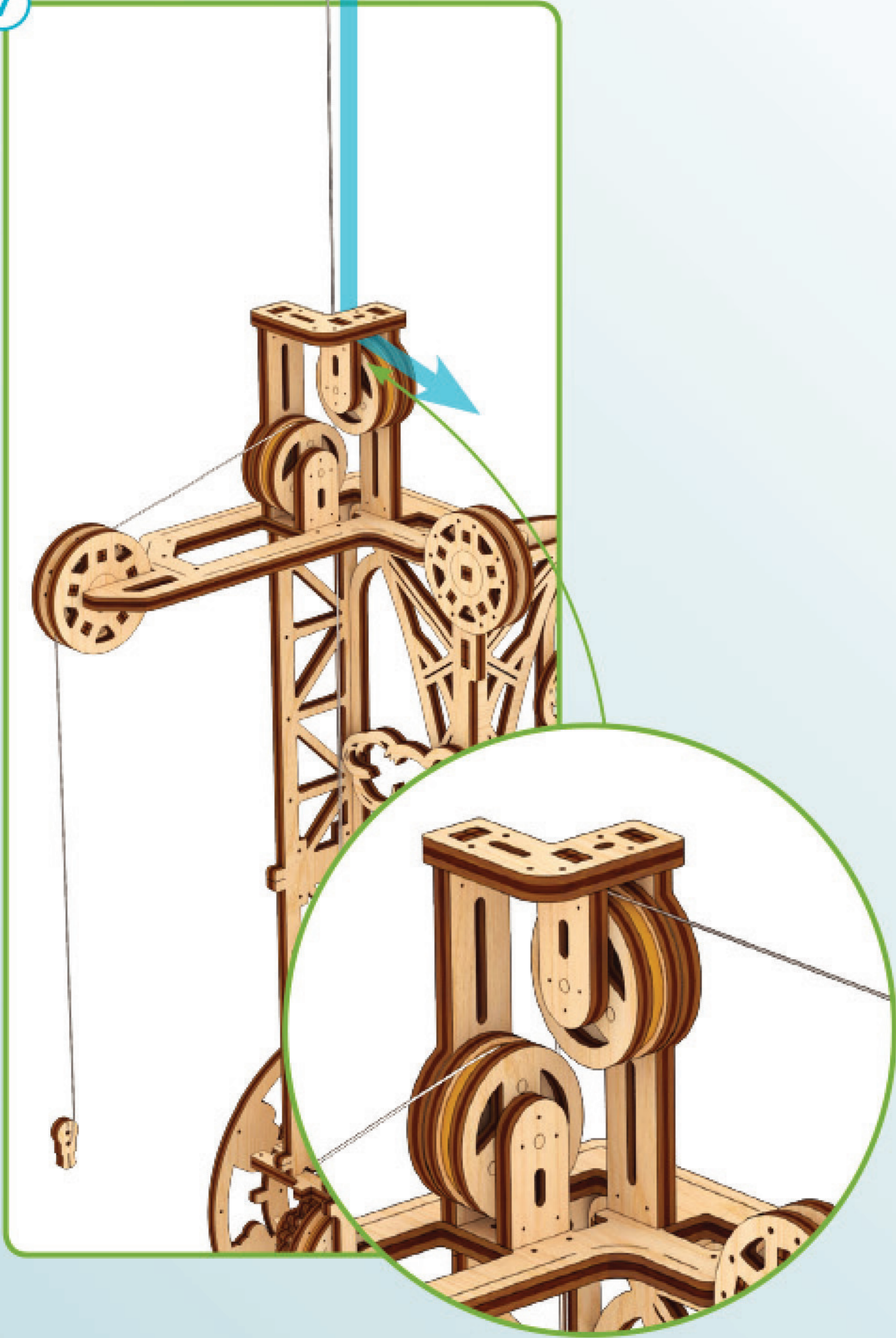

8

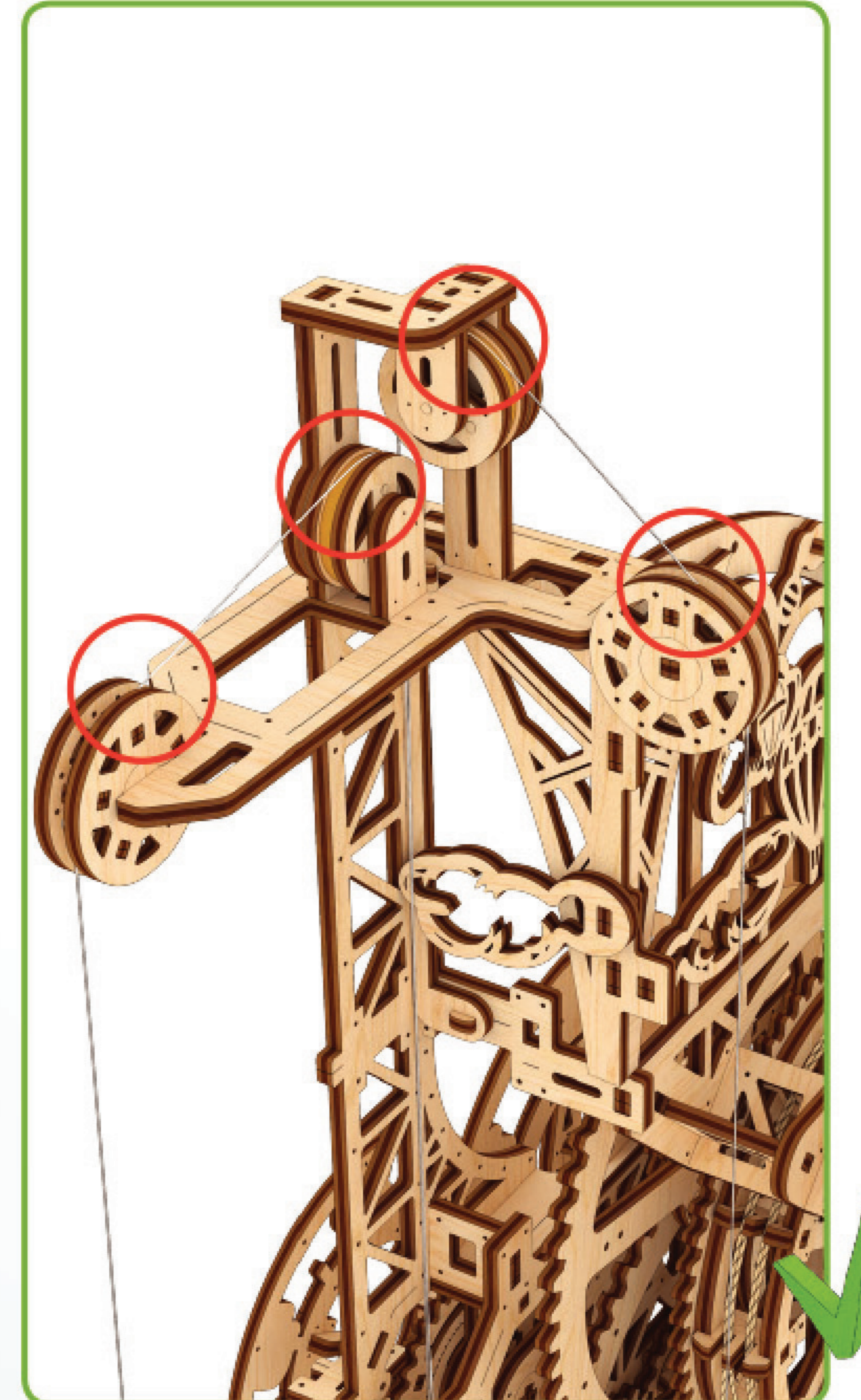
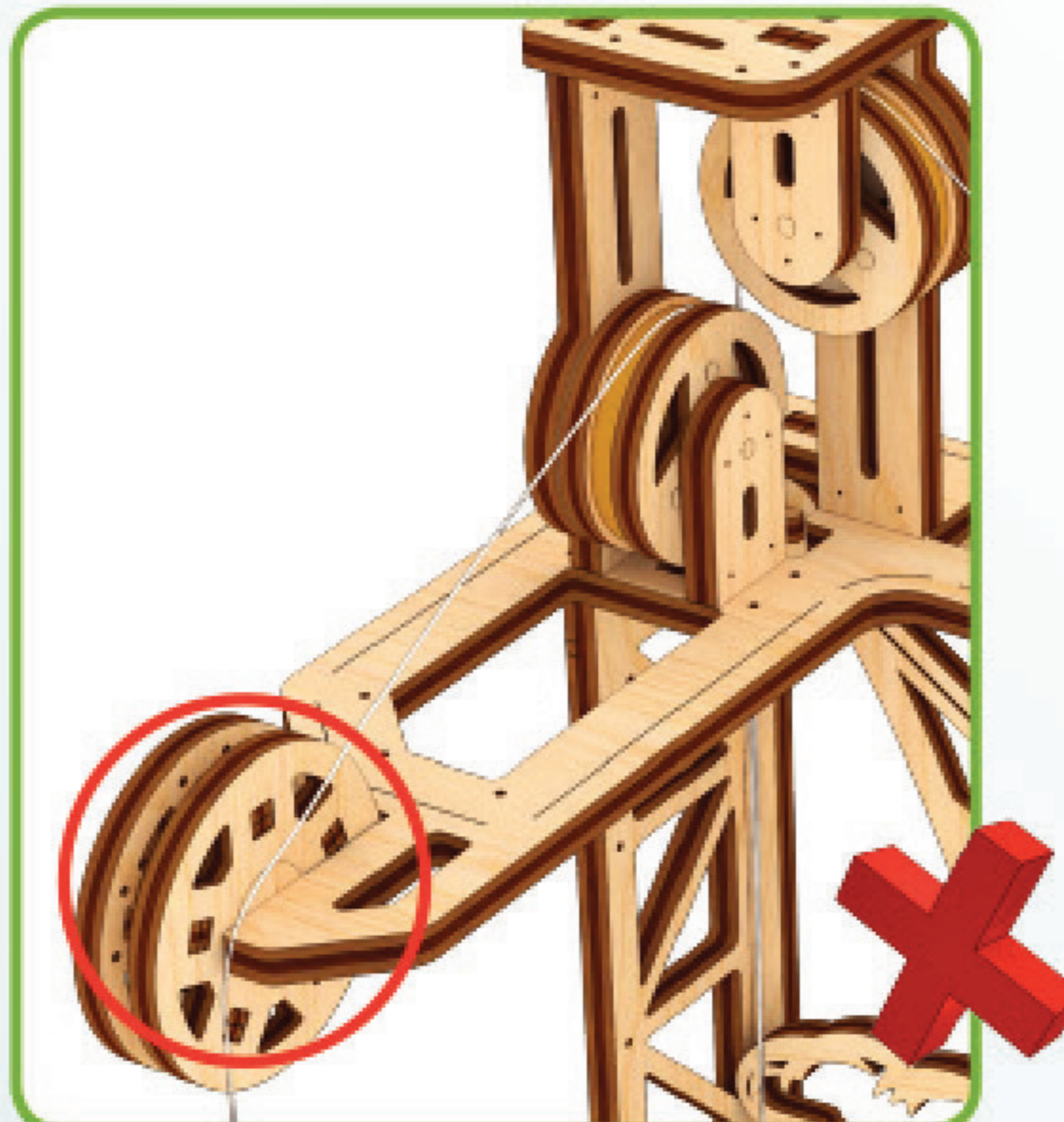
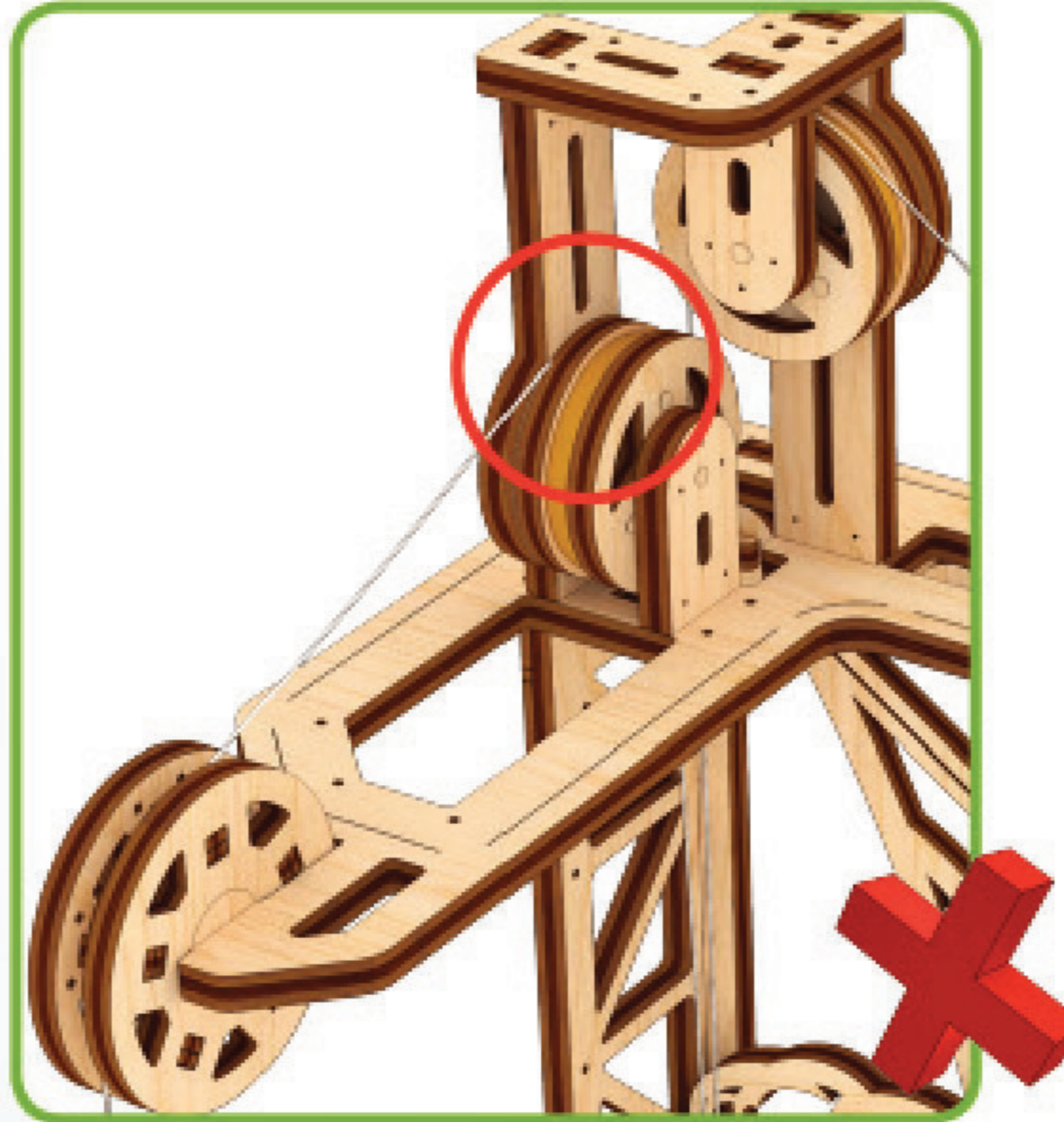

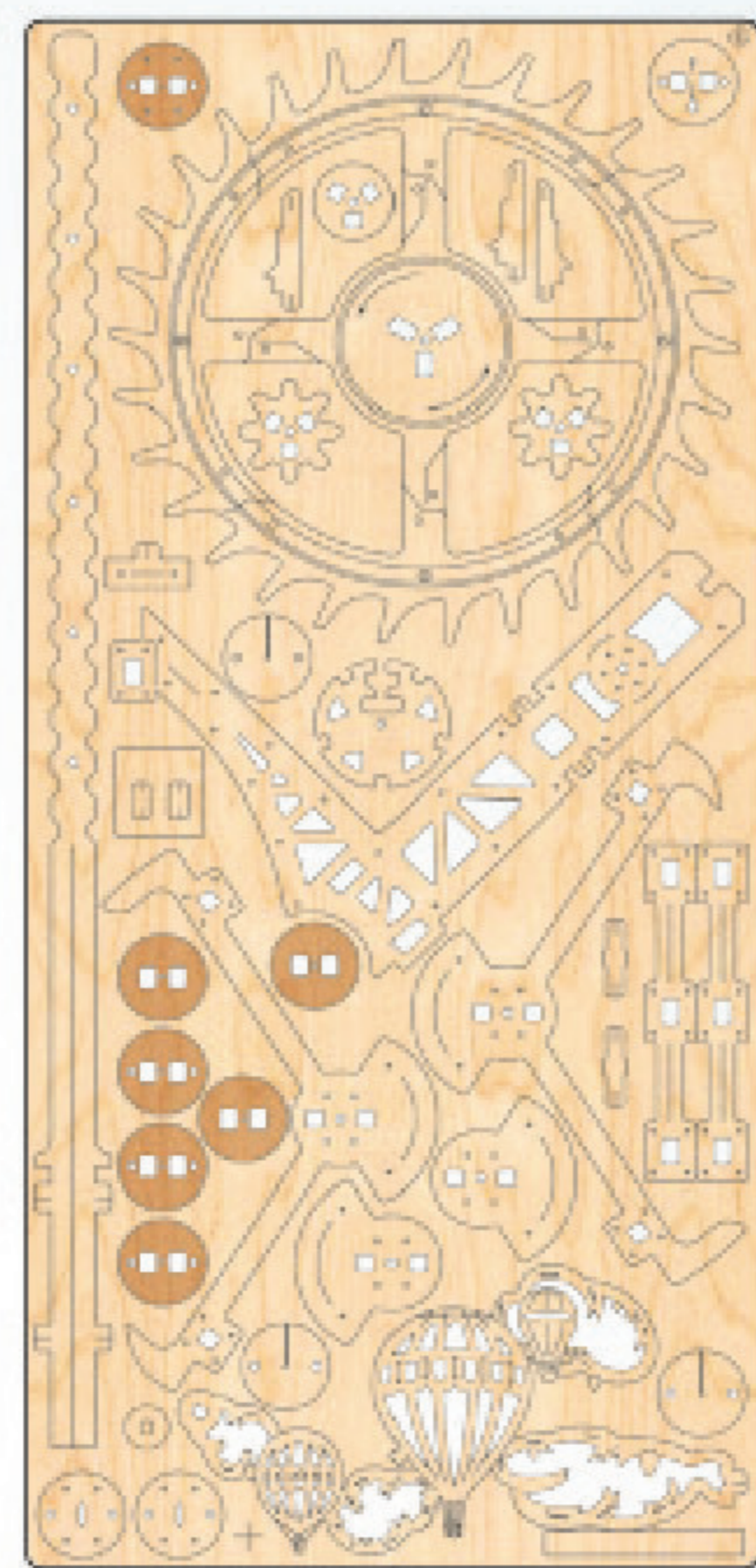
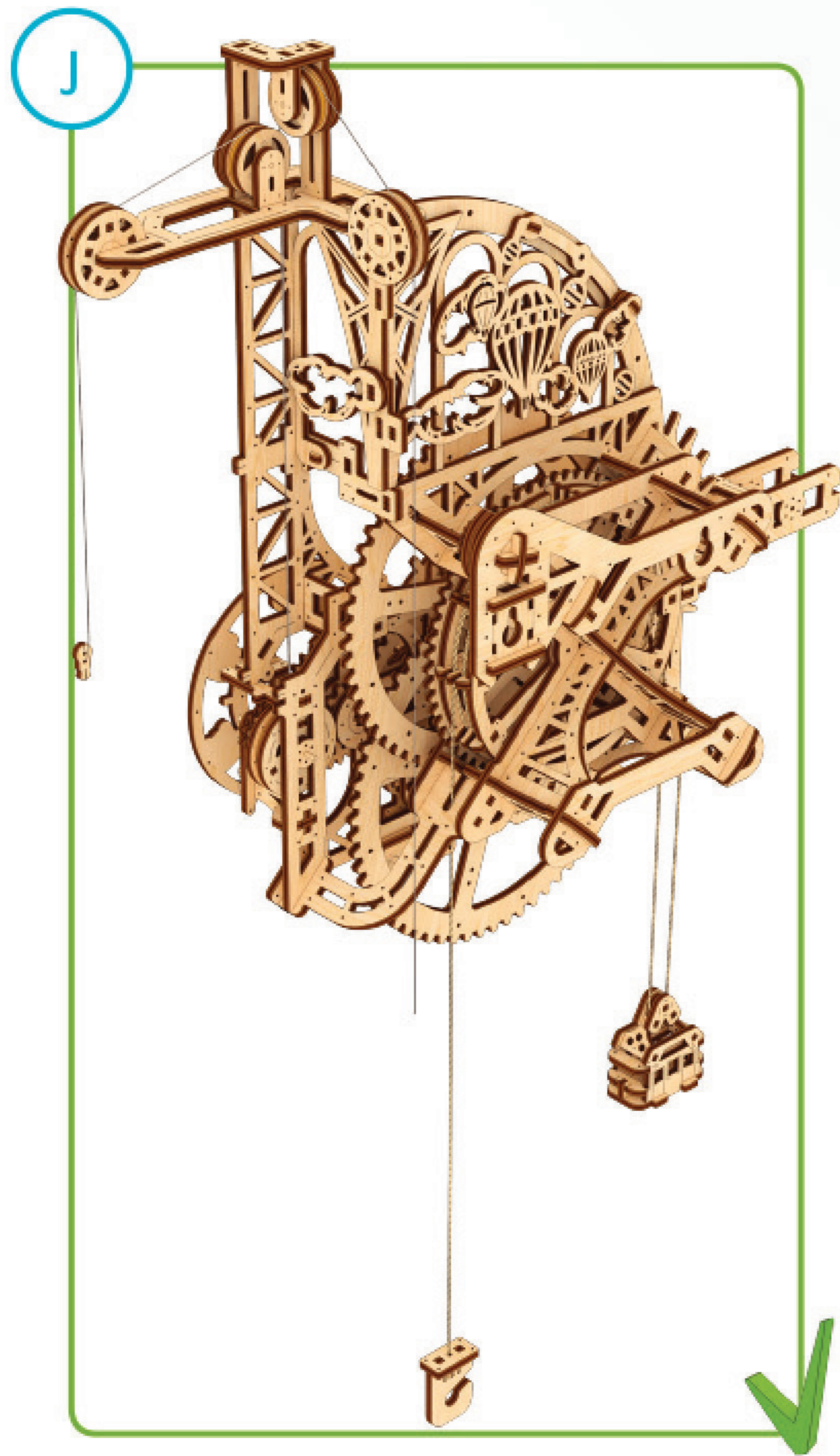

6

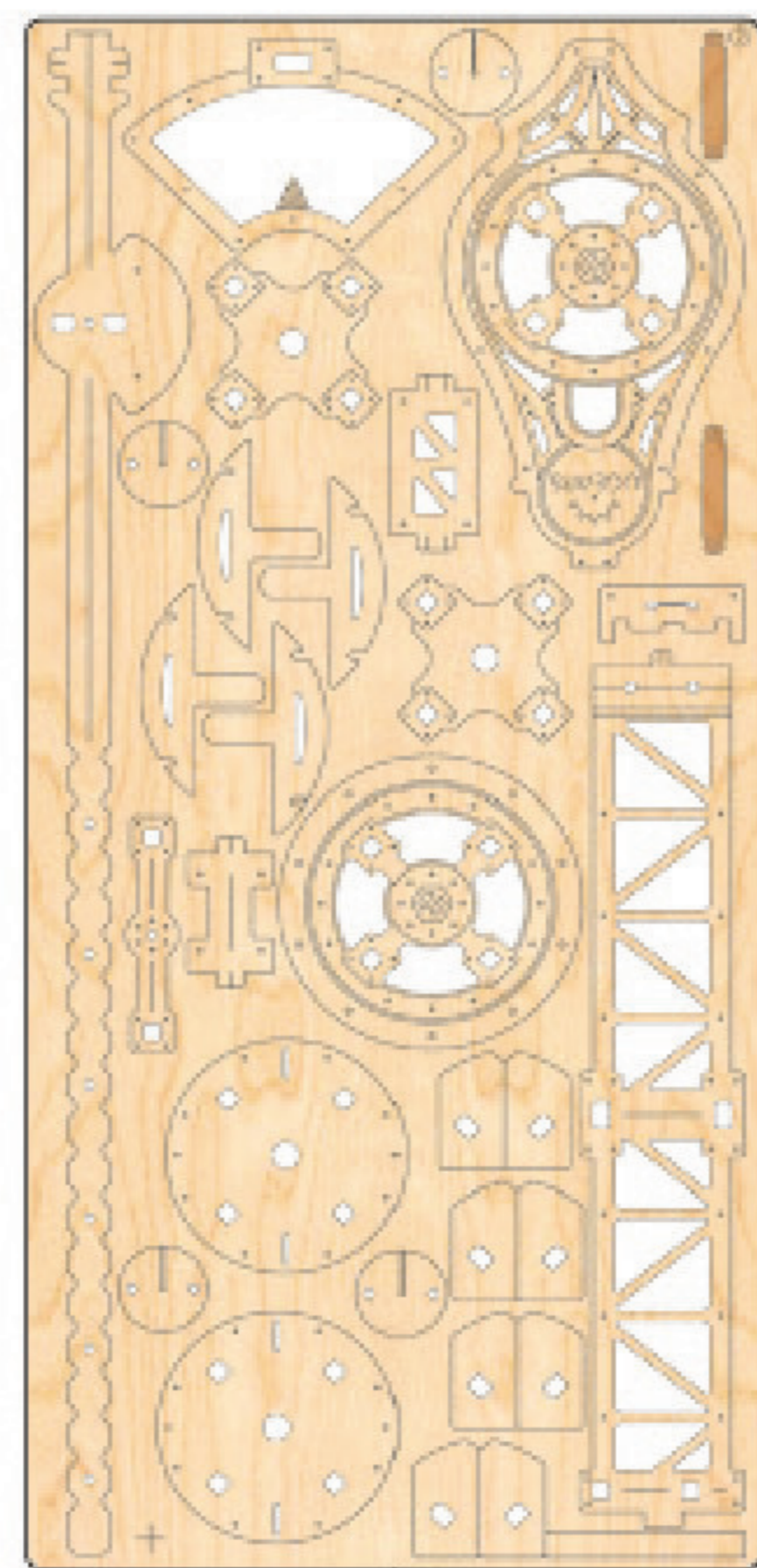

7

1

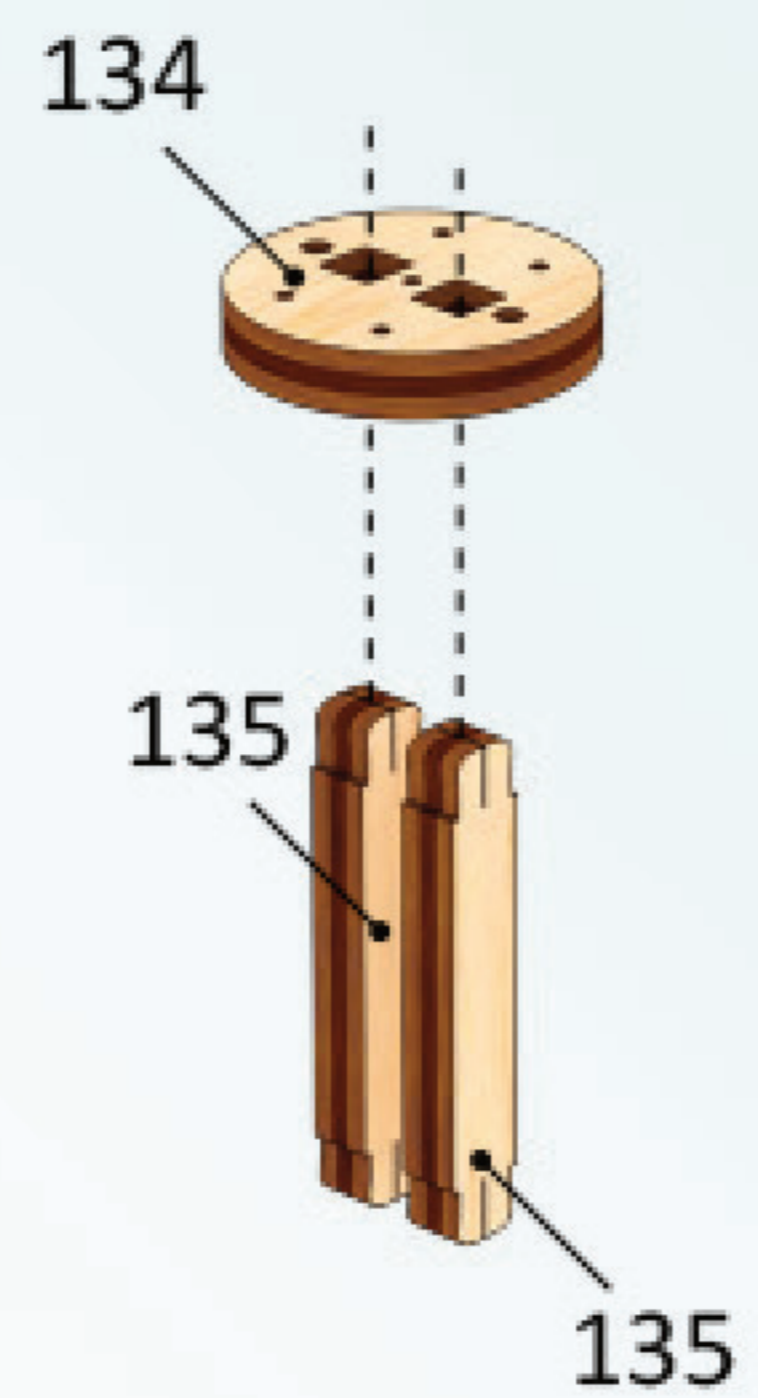

2

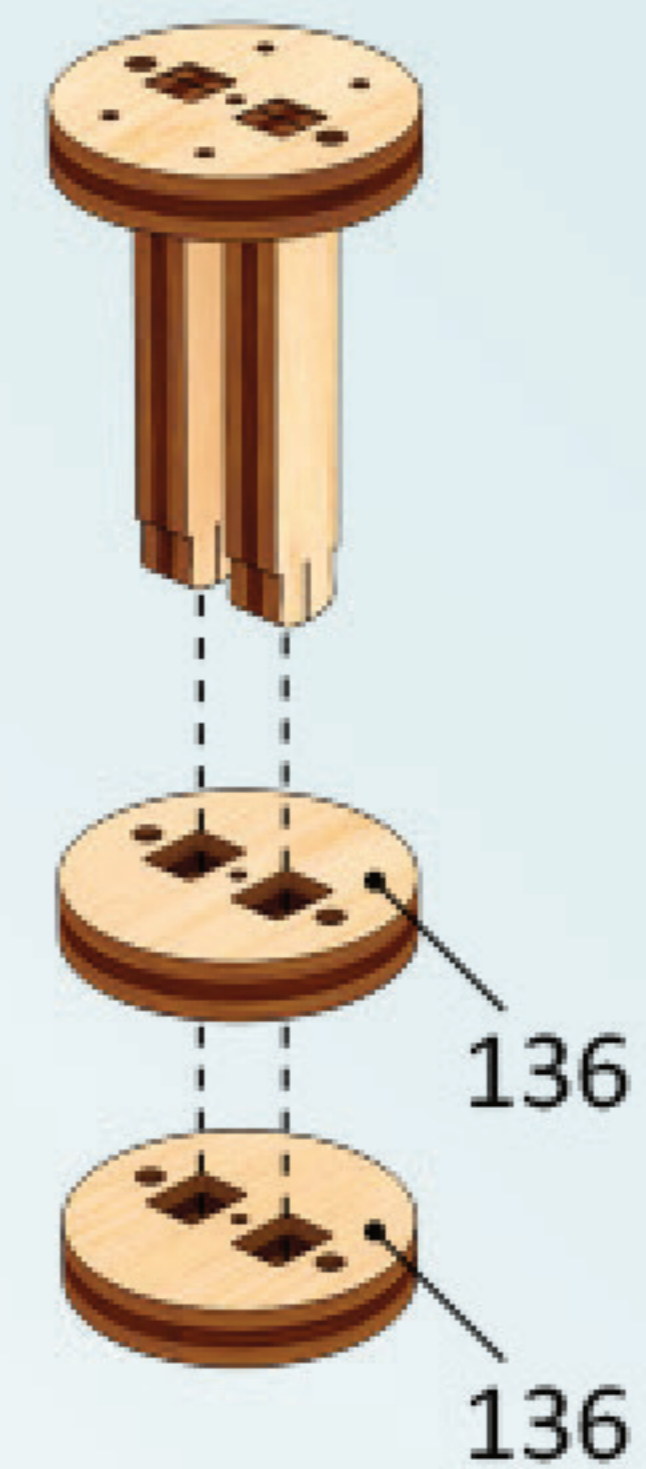

3

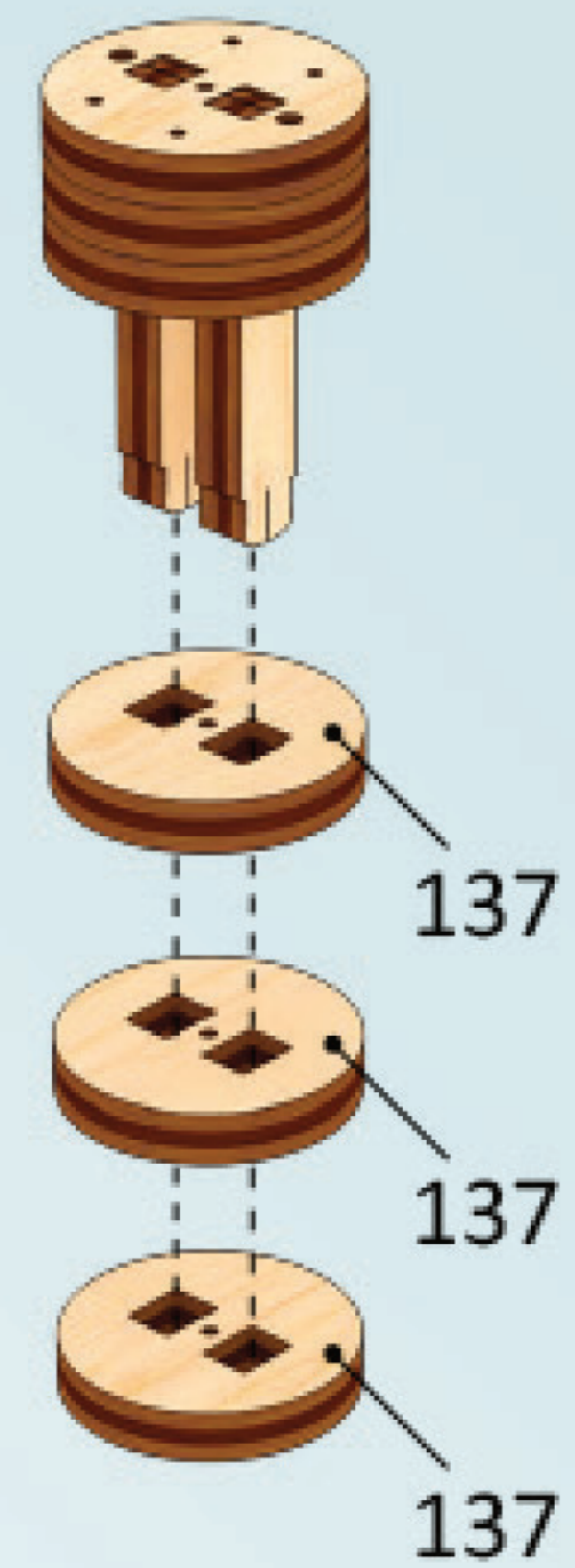

4

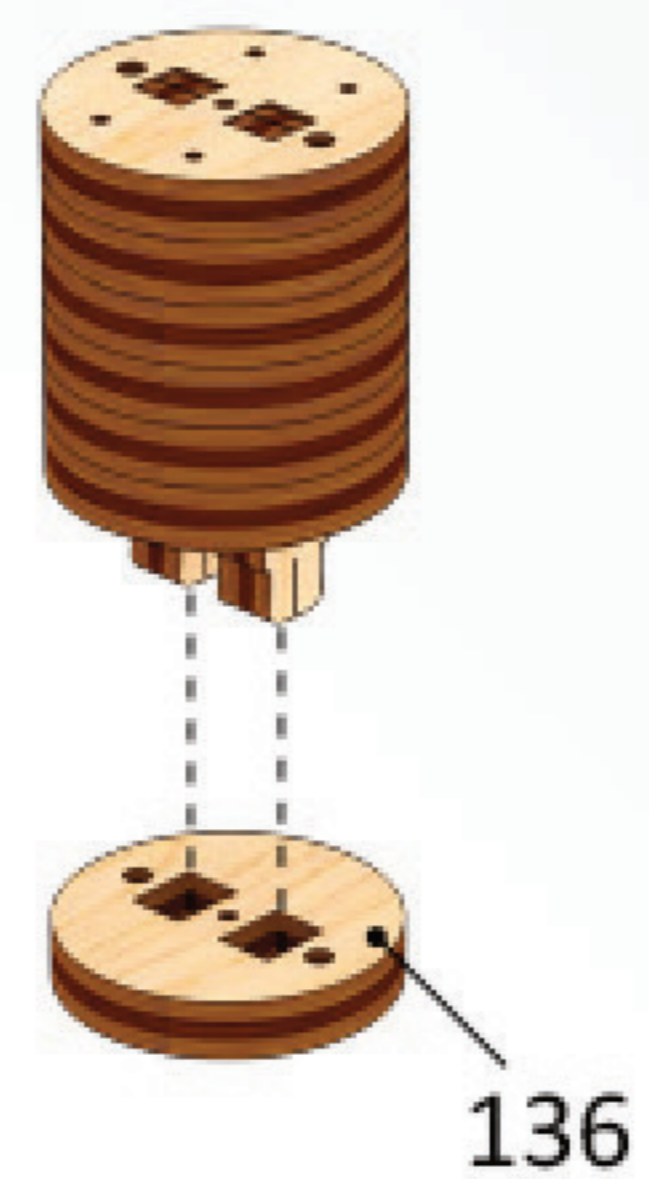

x2

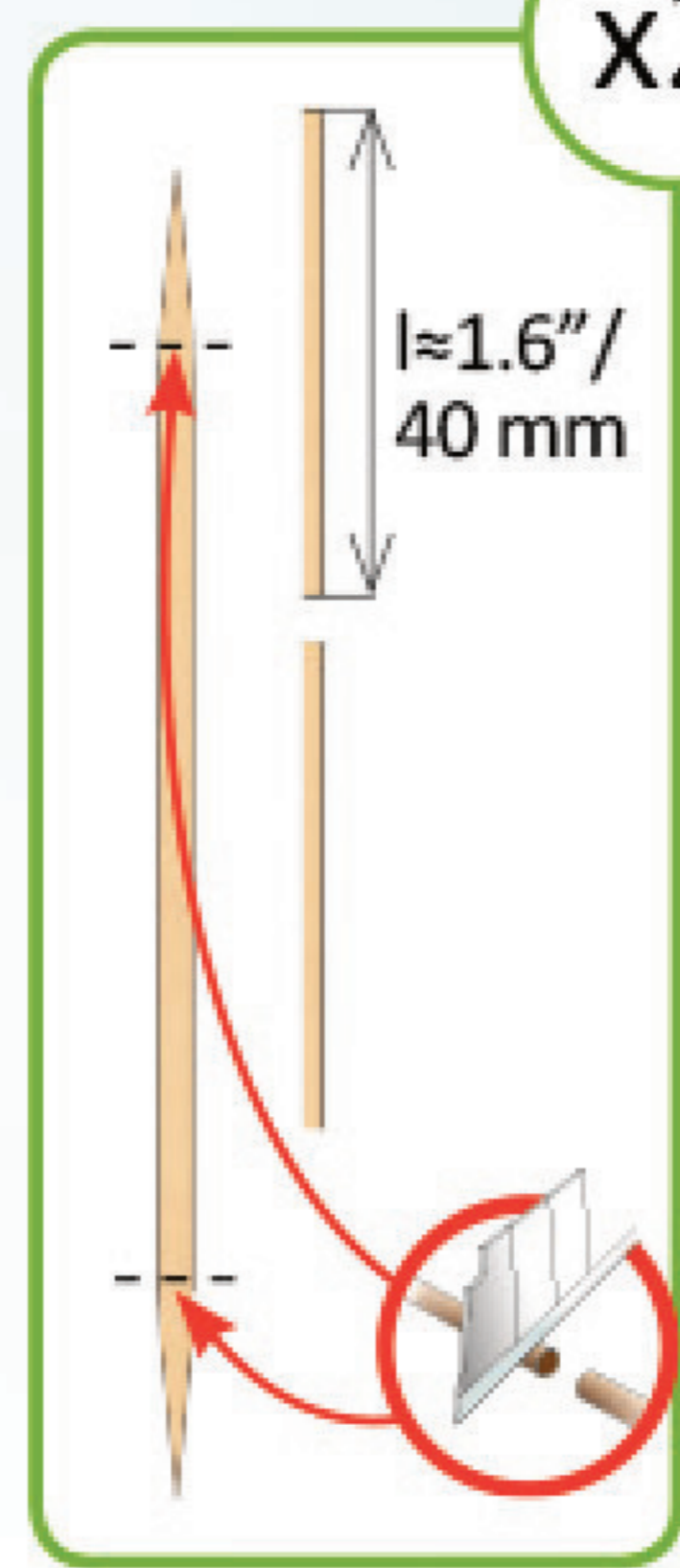

5

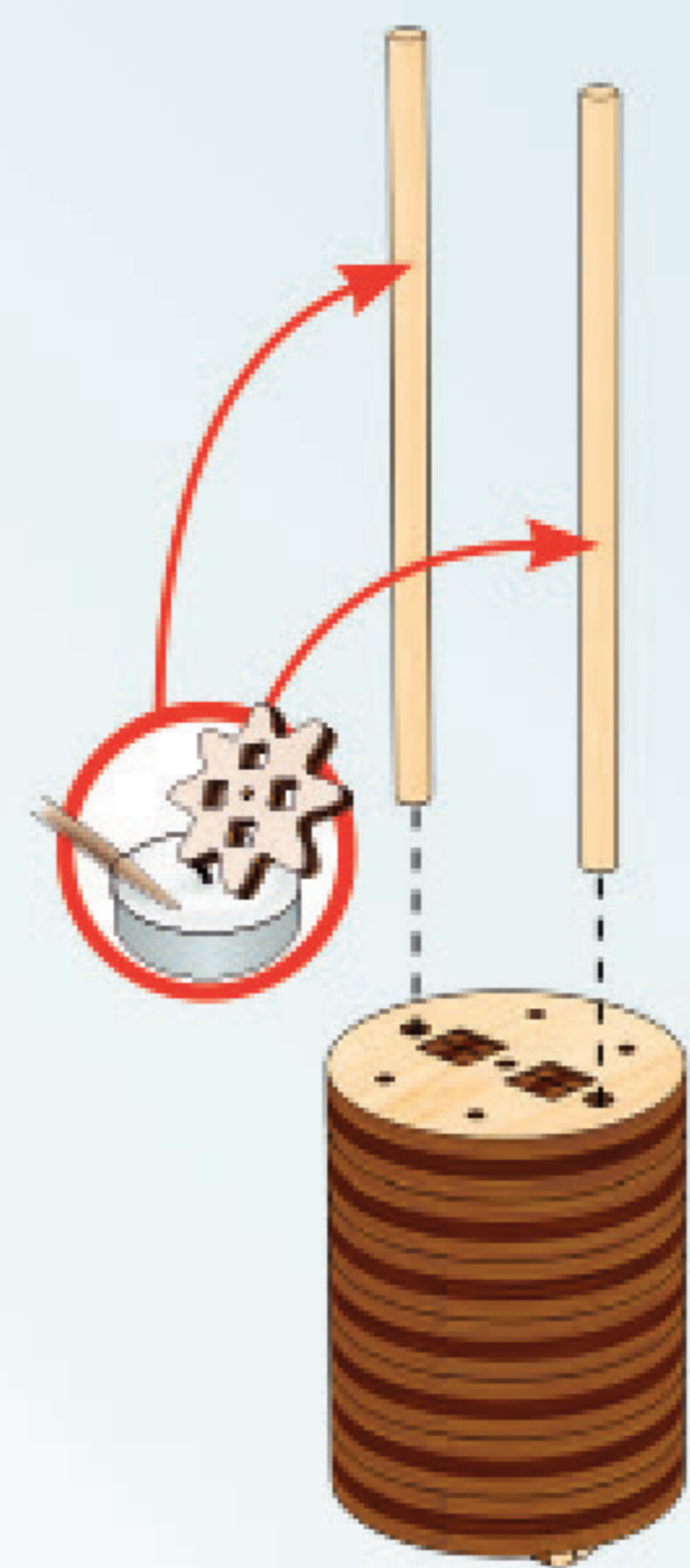

K

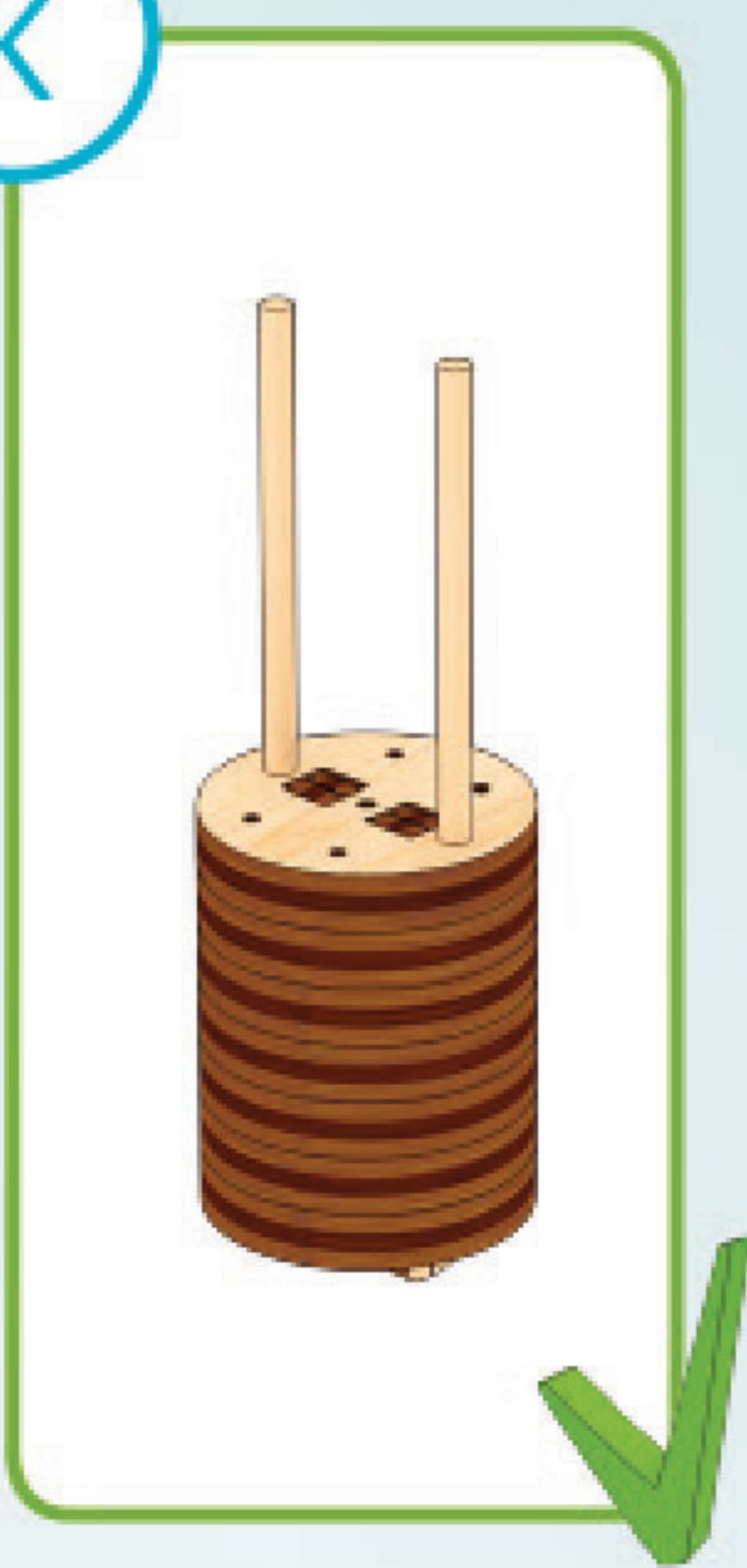

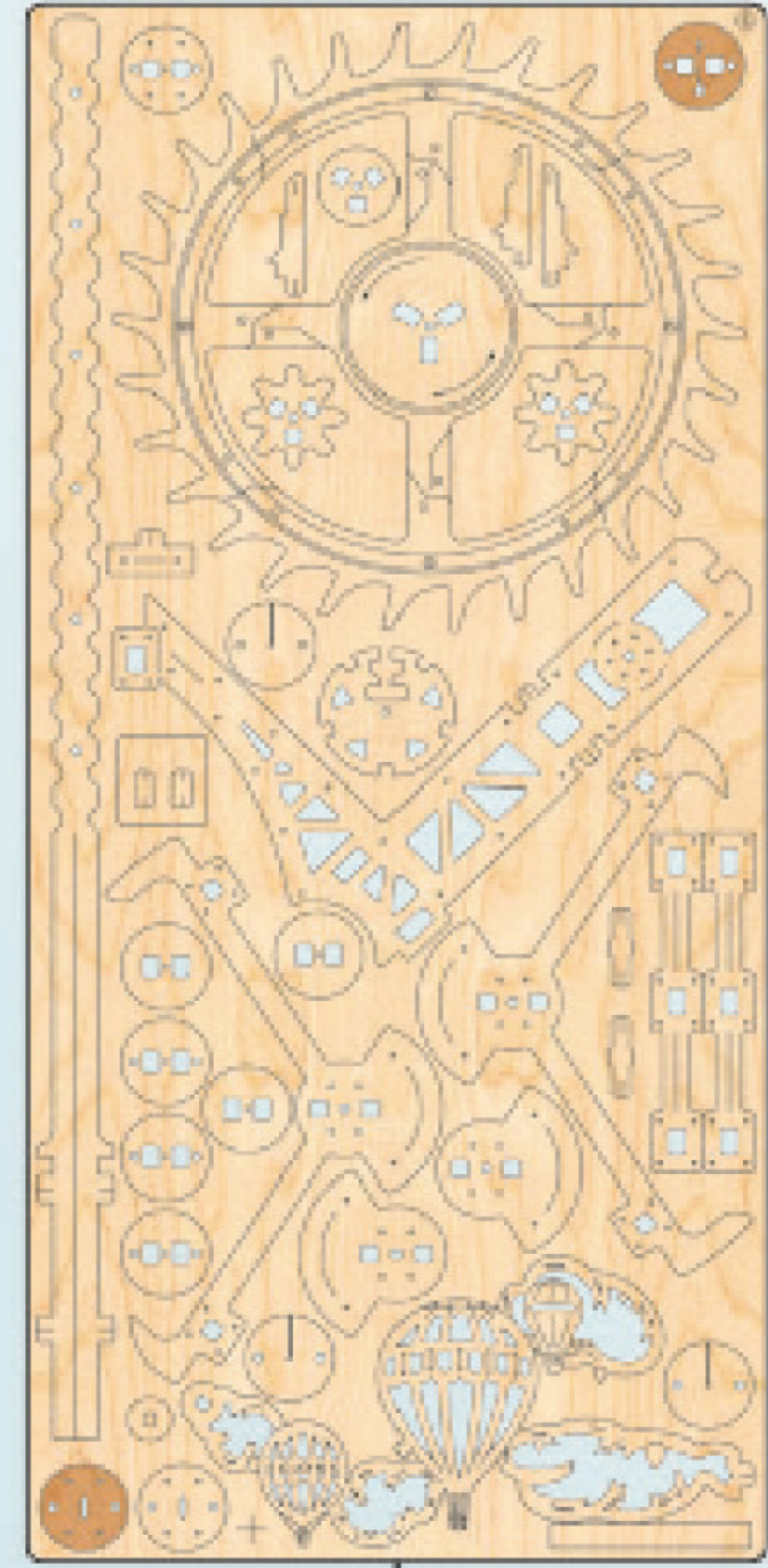

6

1

1

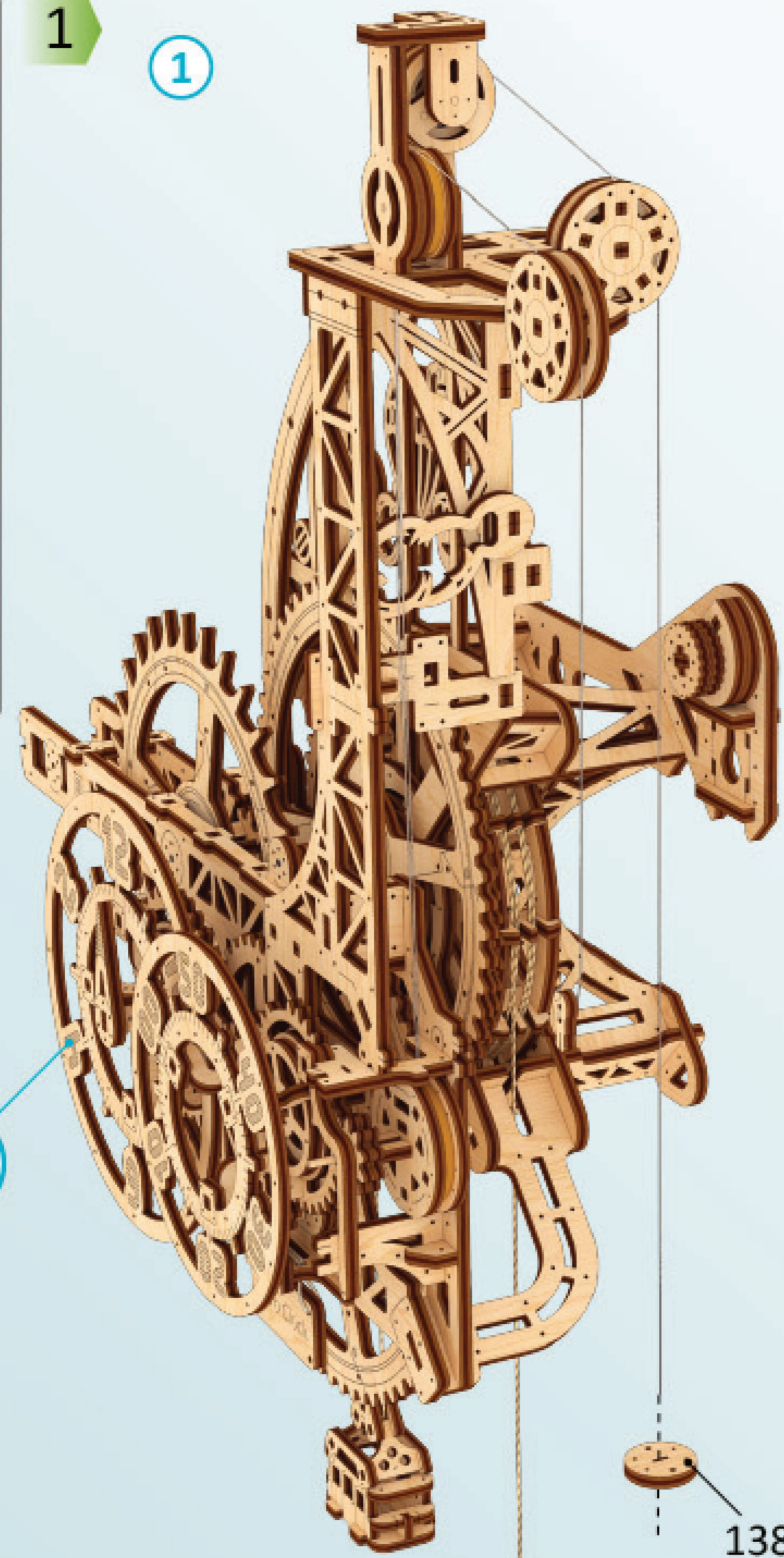

138

2

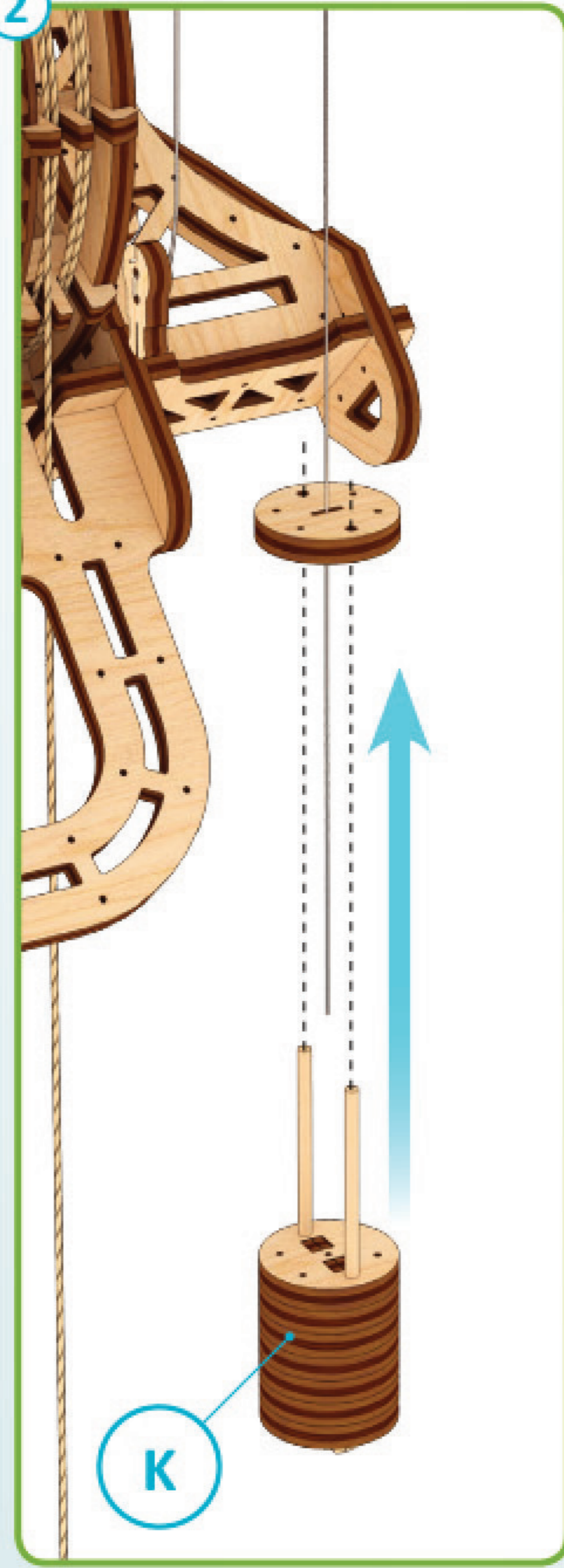

K

3

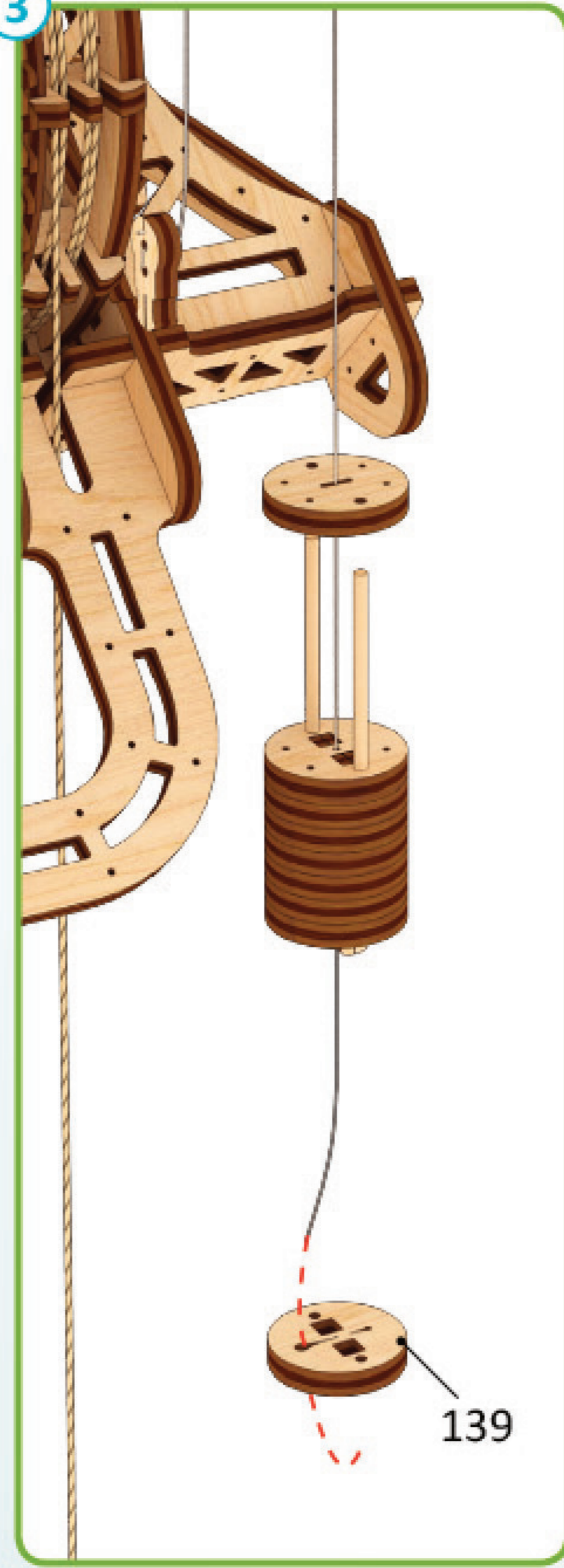

139

4

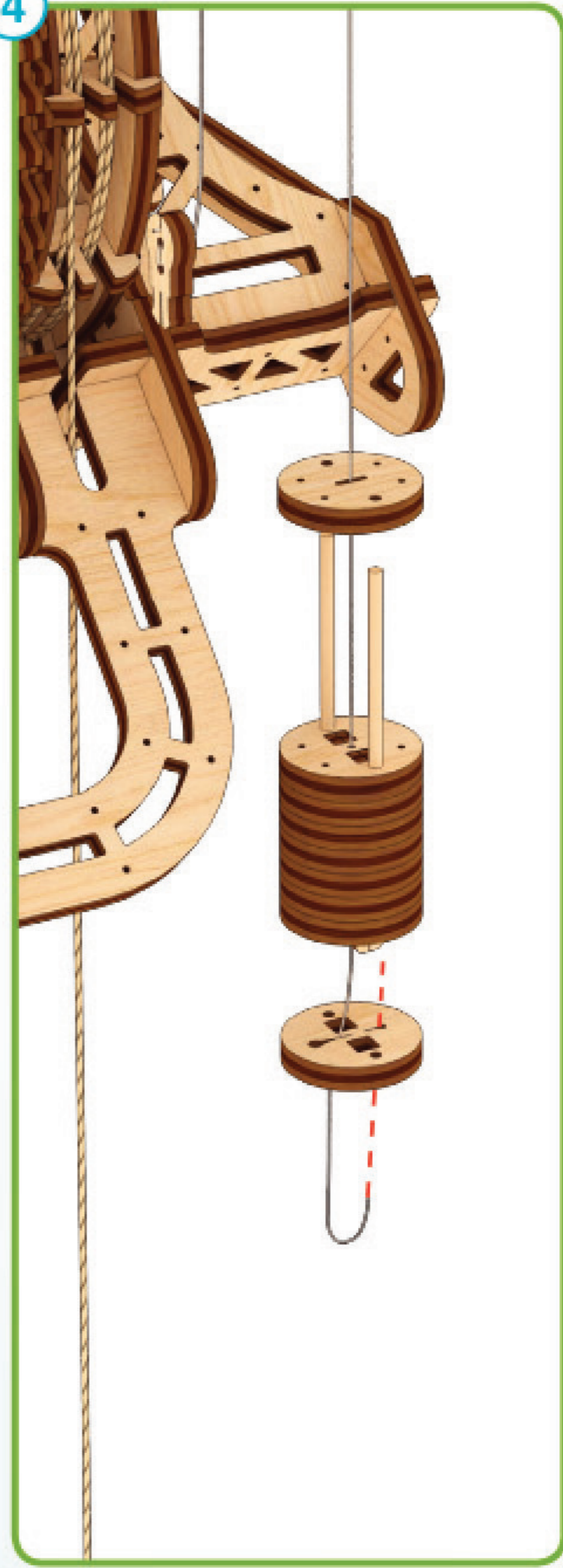

5

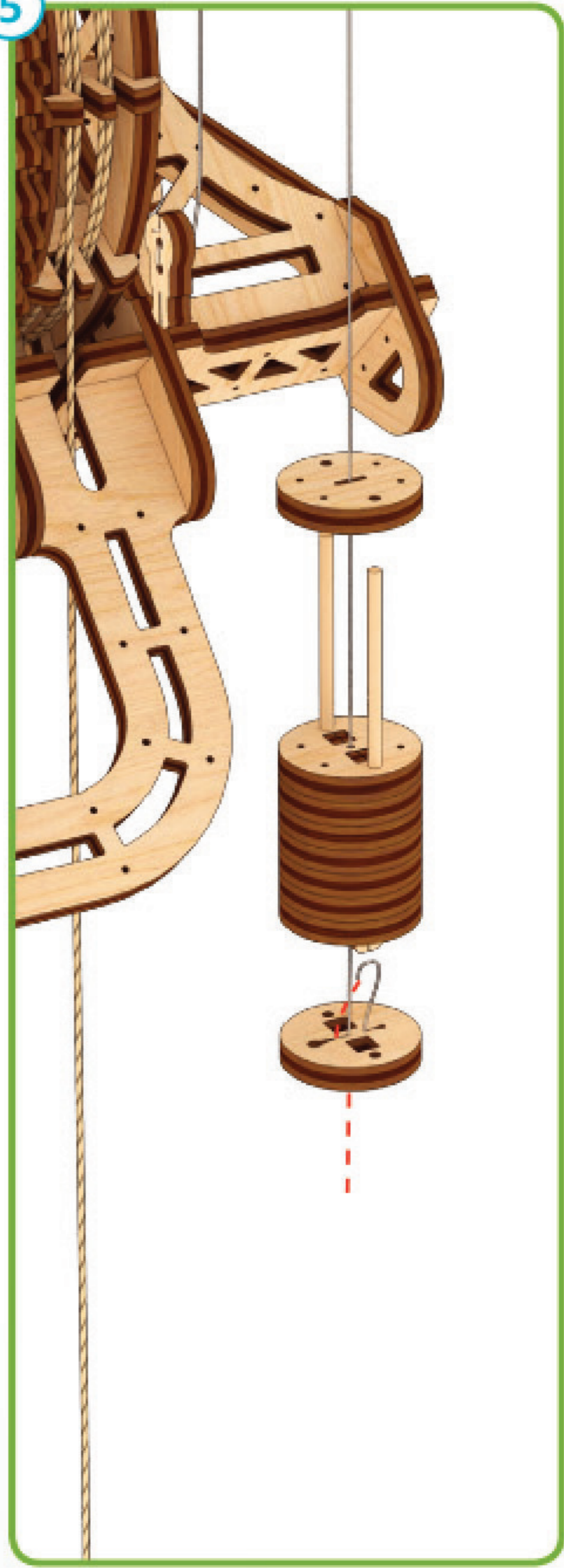

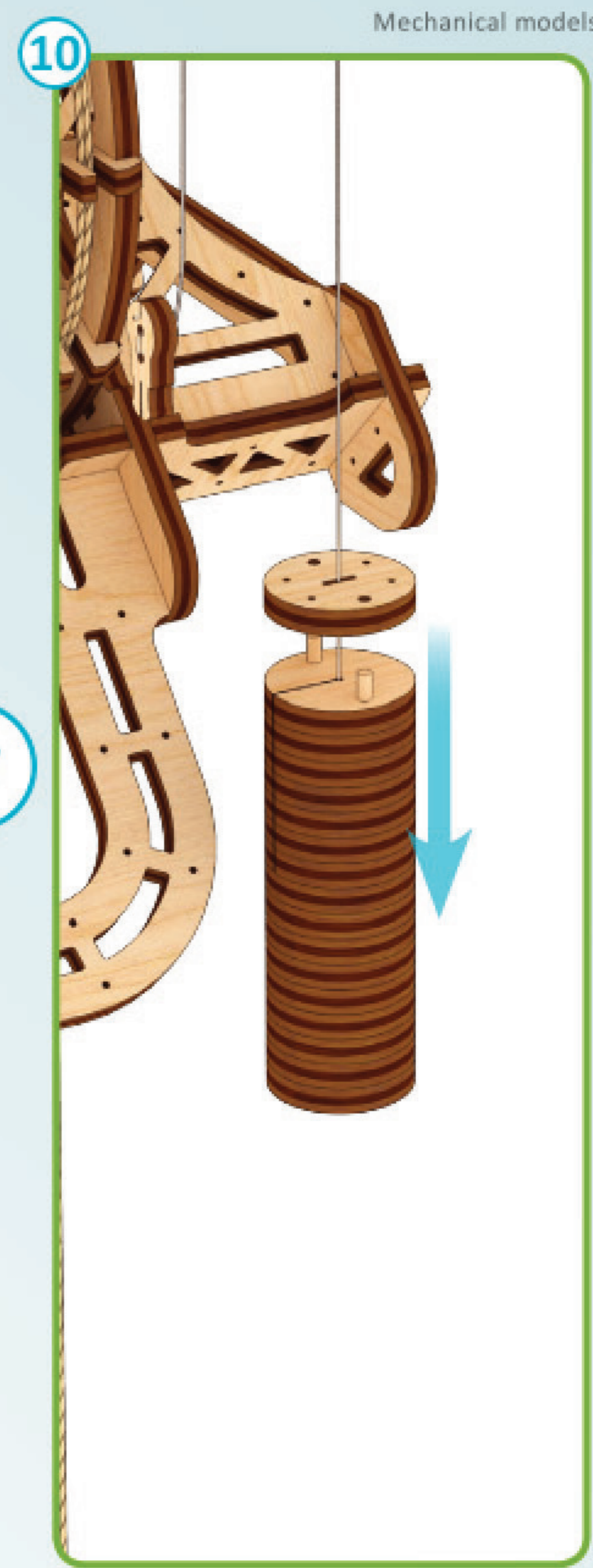
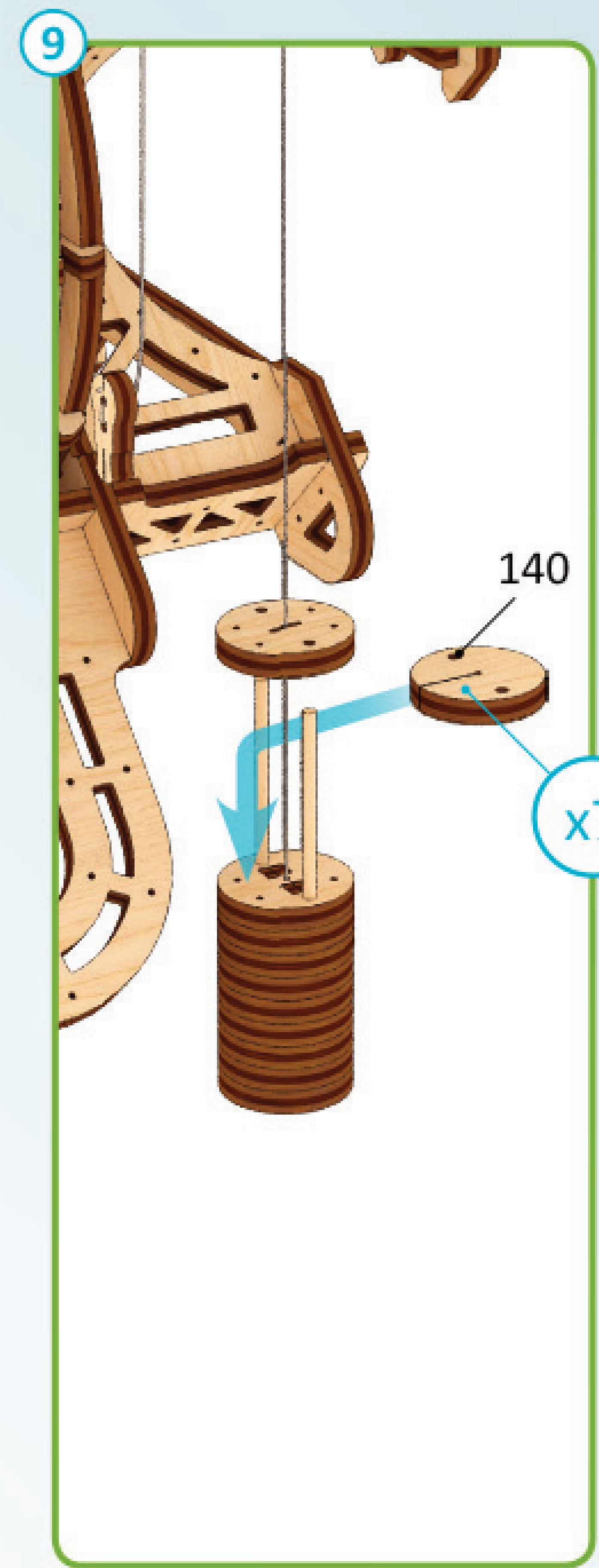
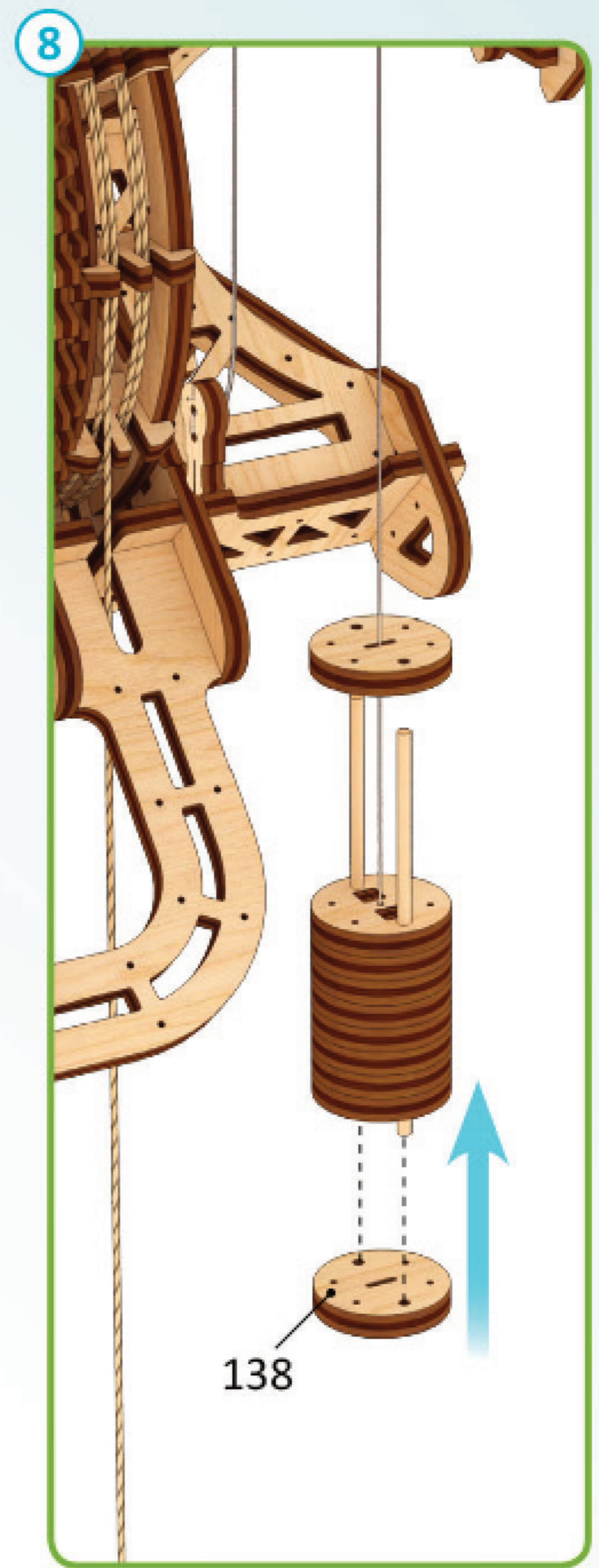
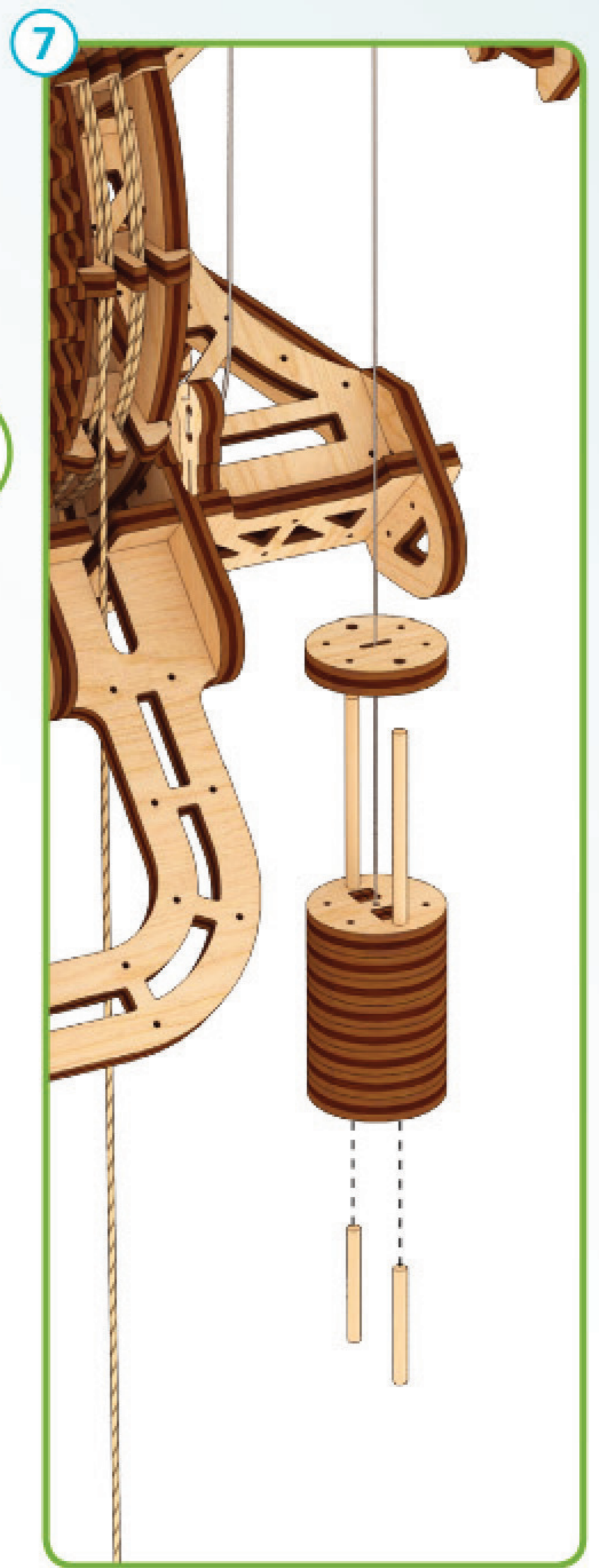
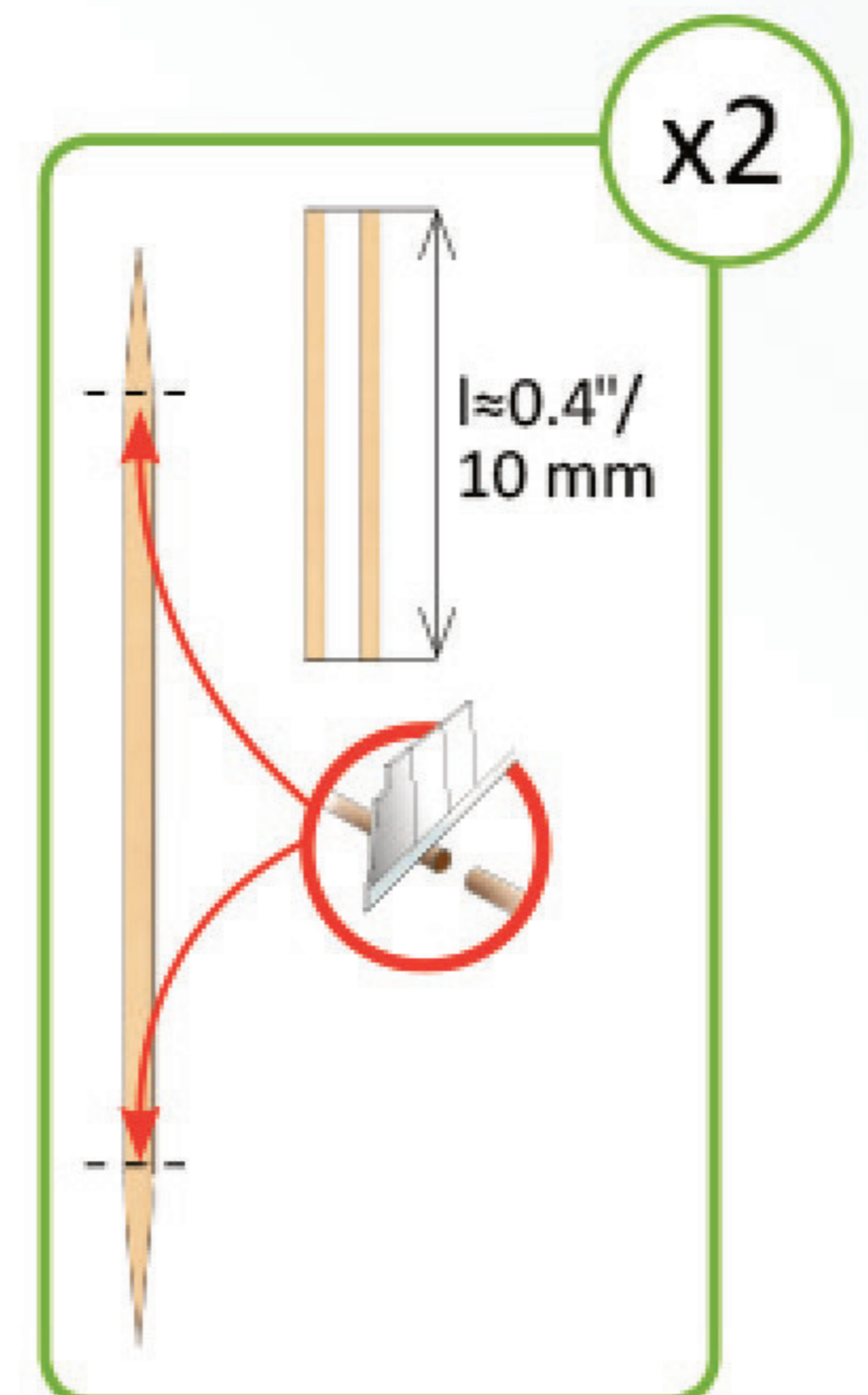
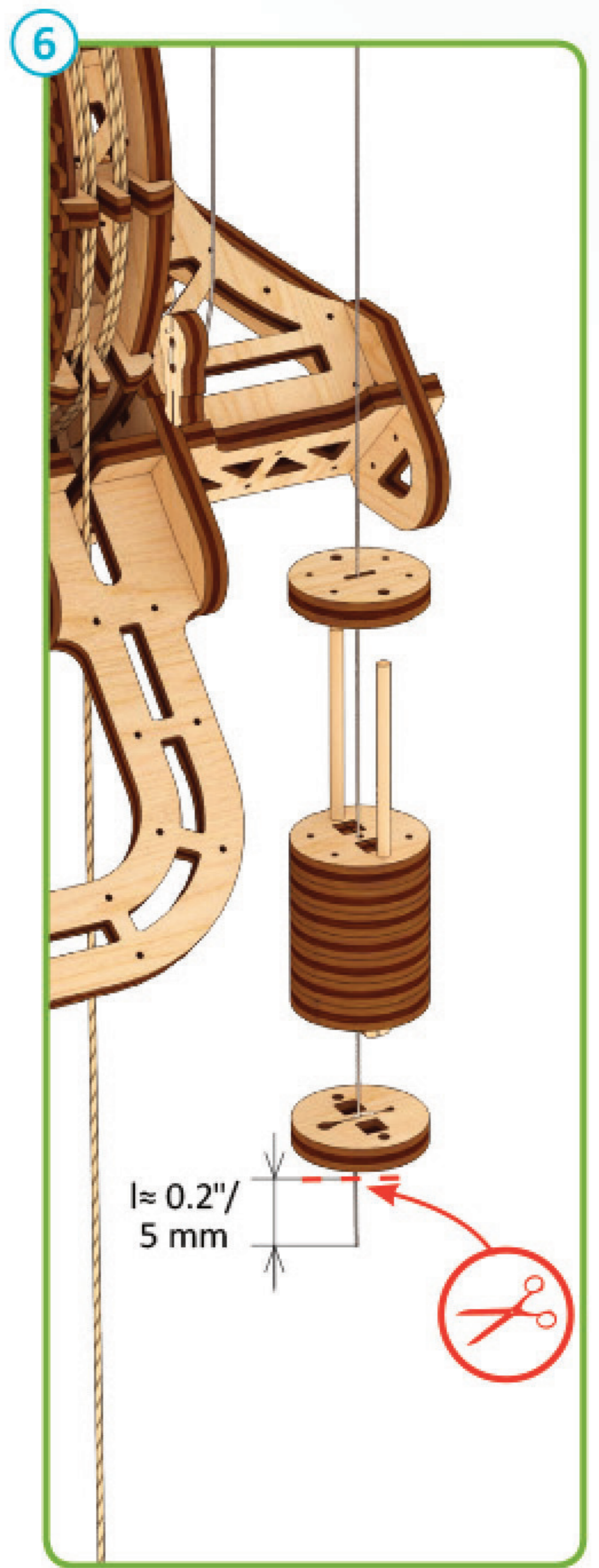
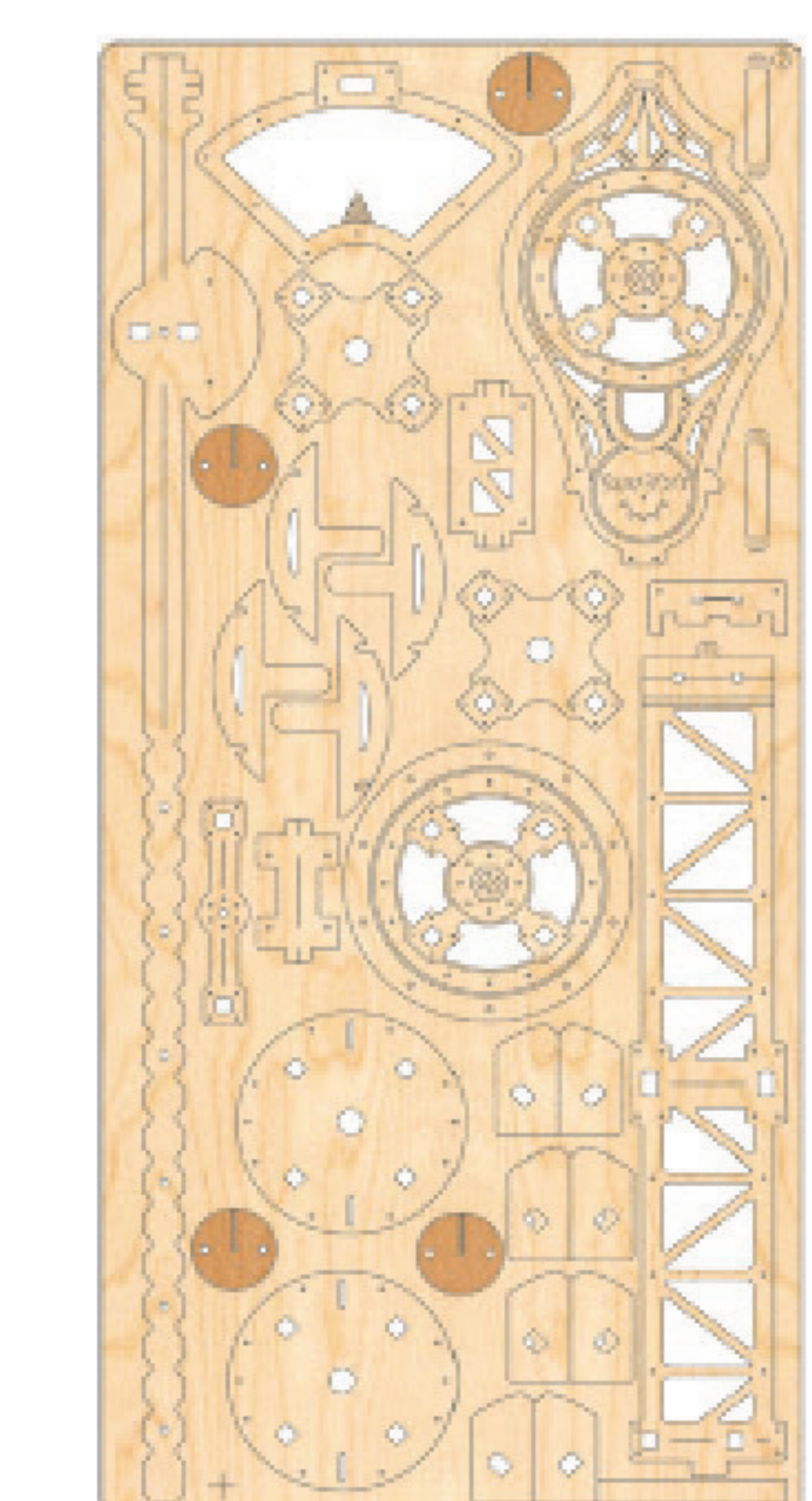
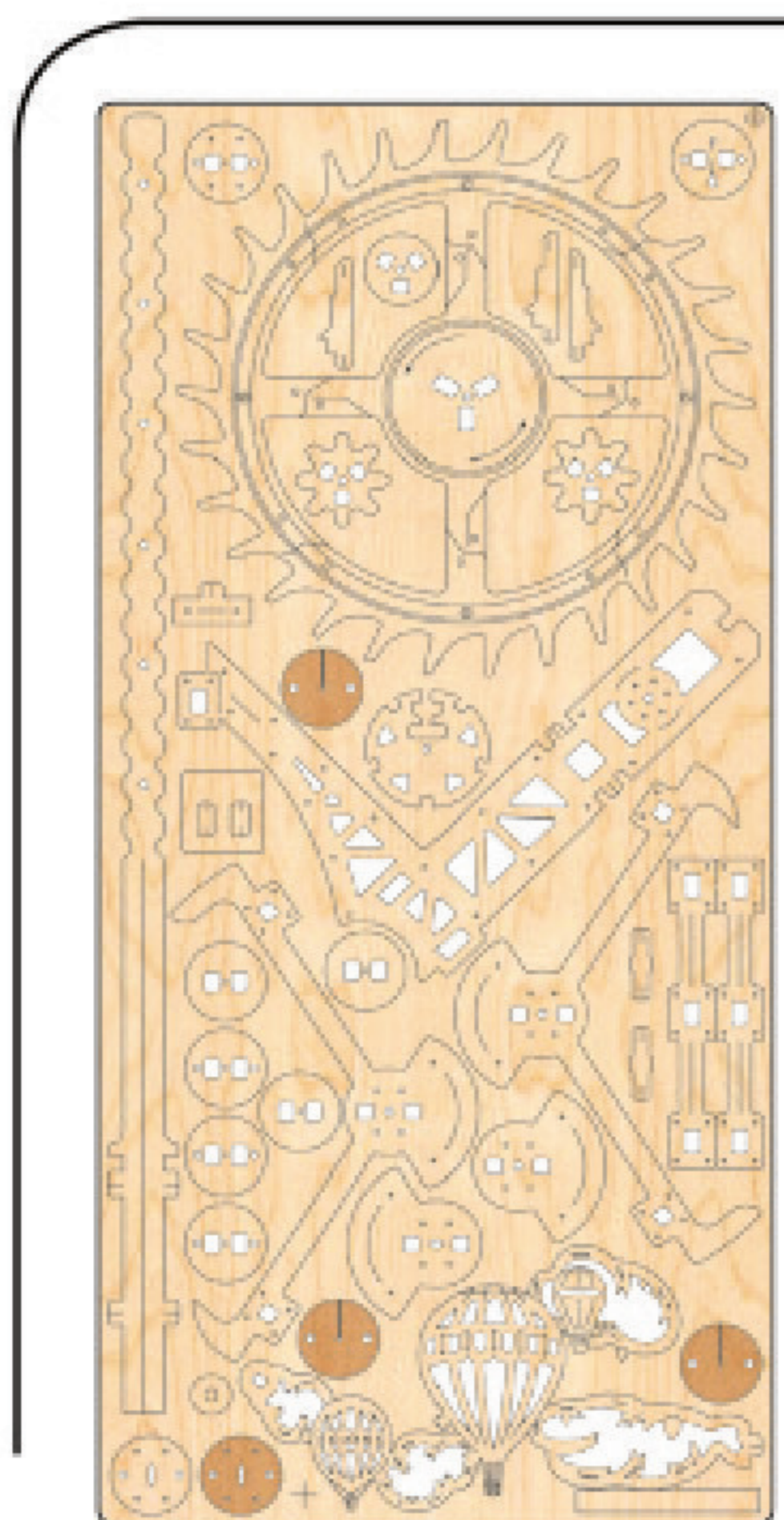

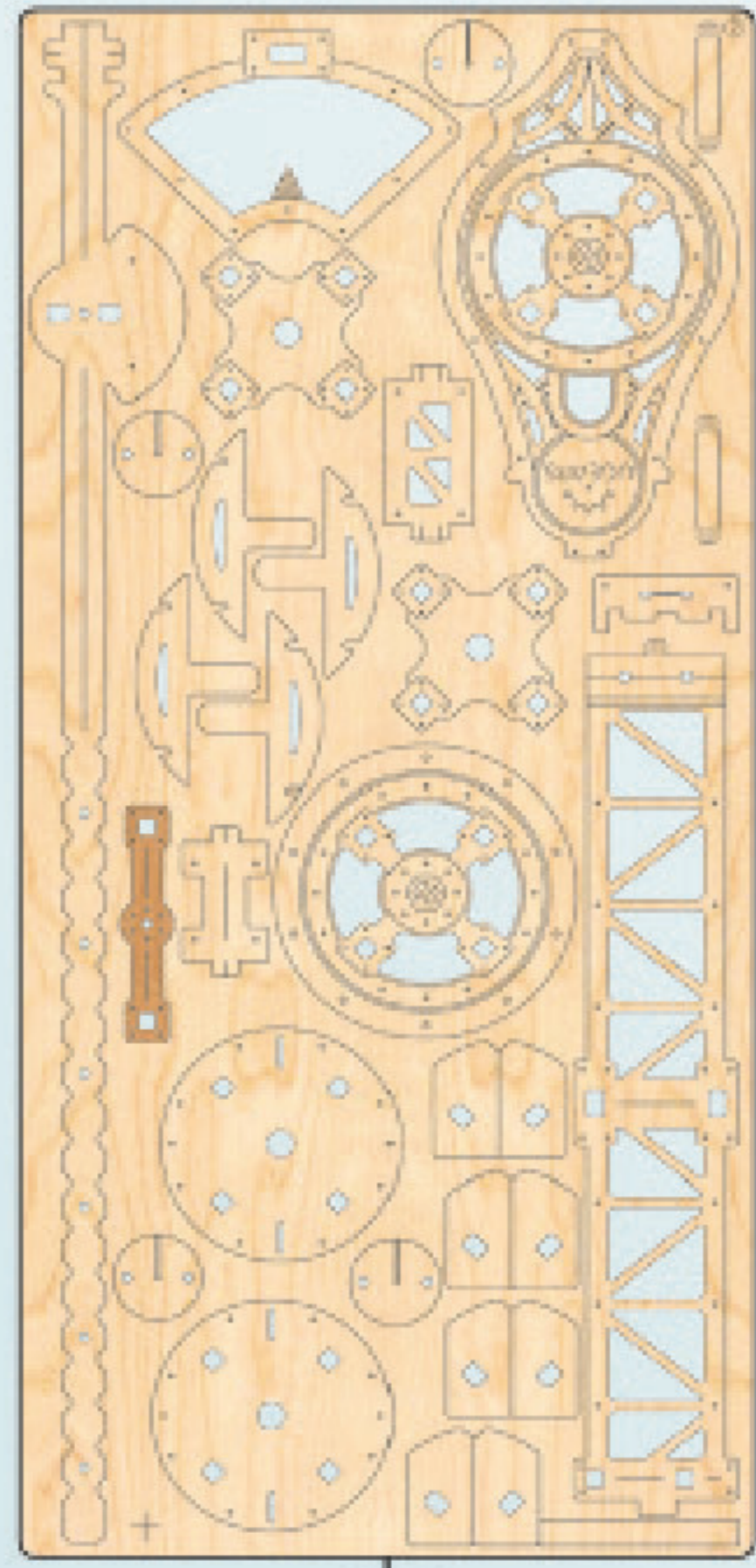

2

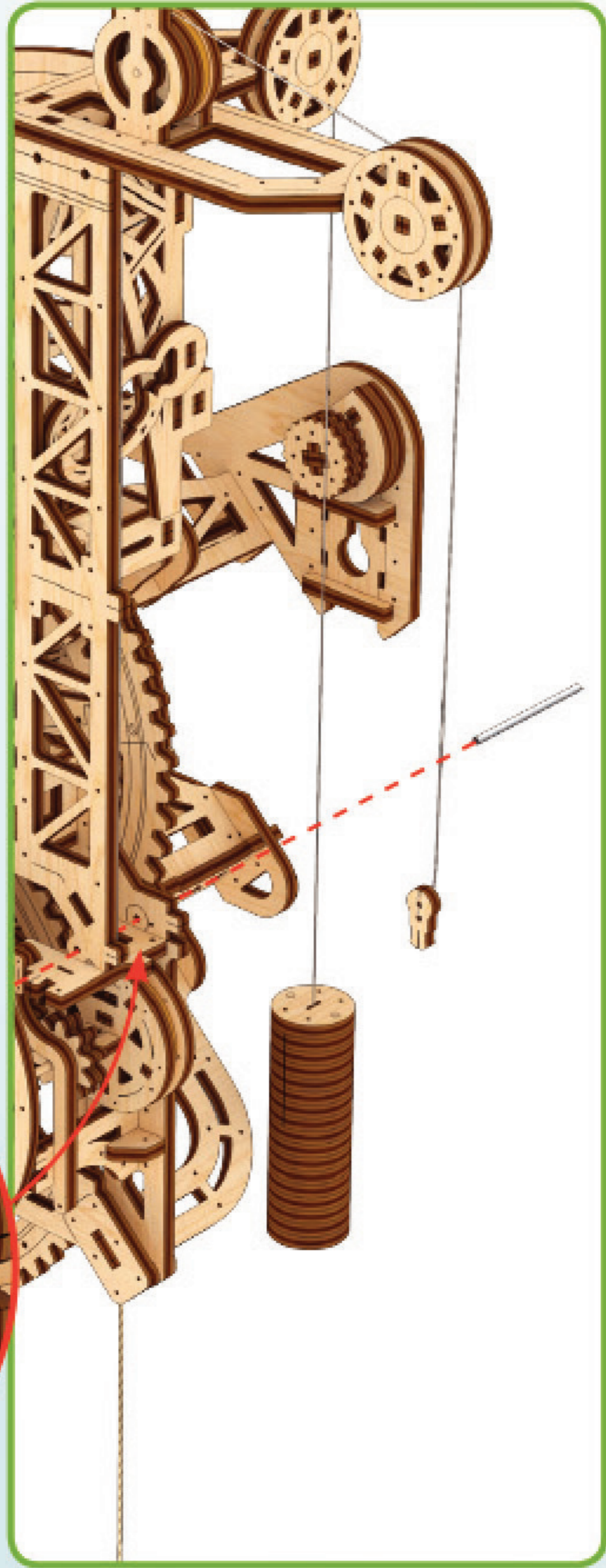
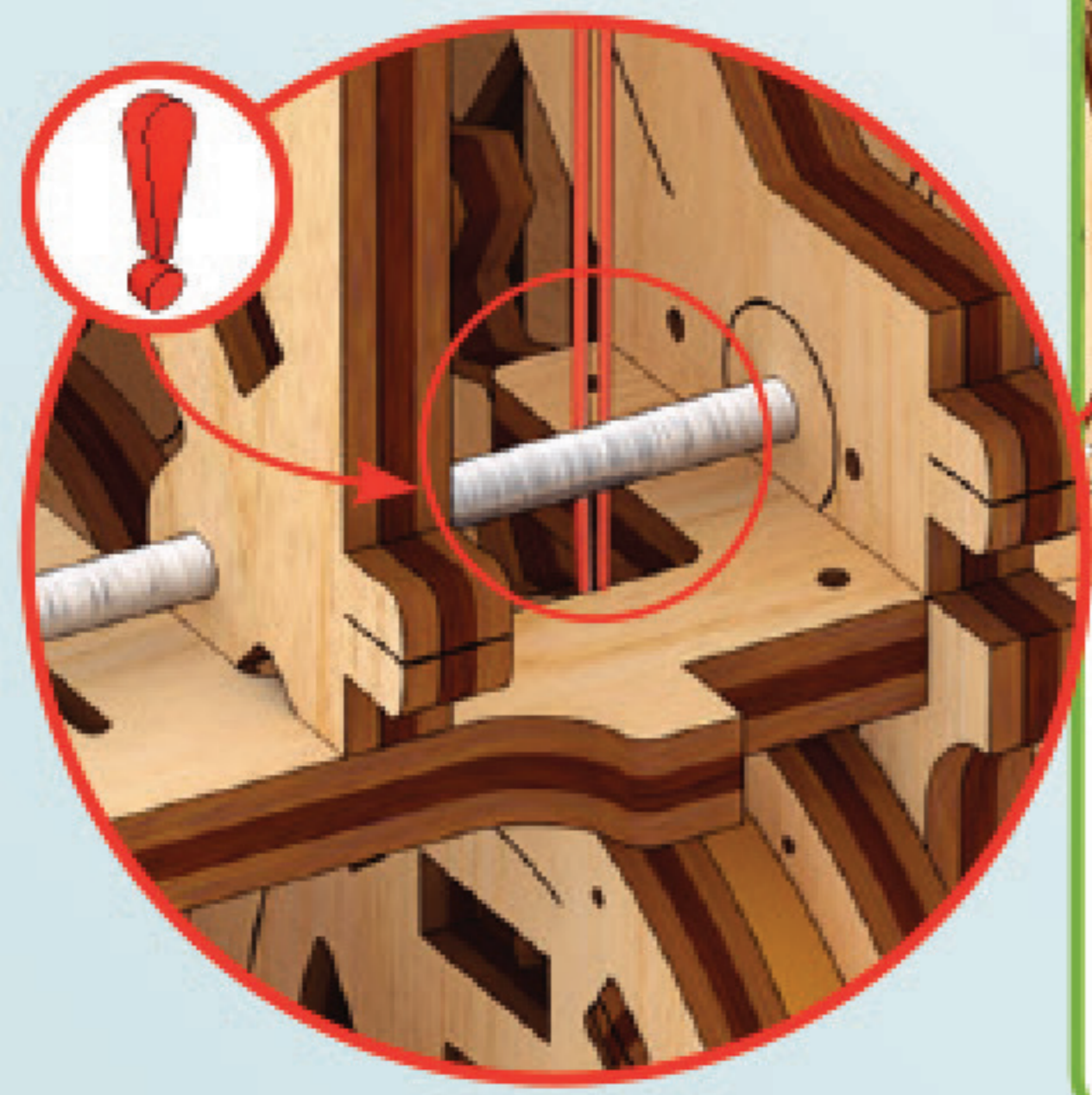

3

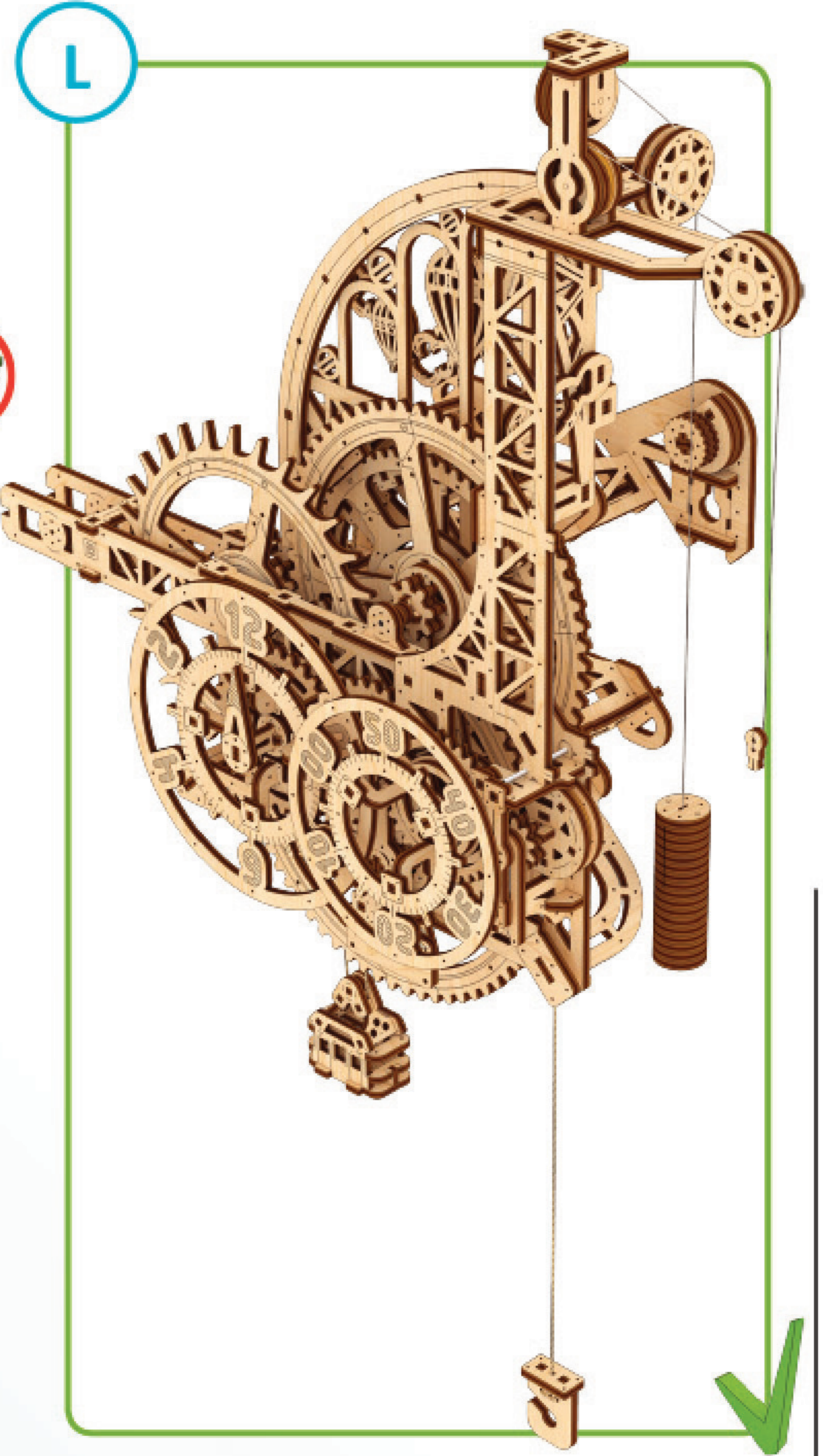
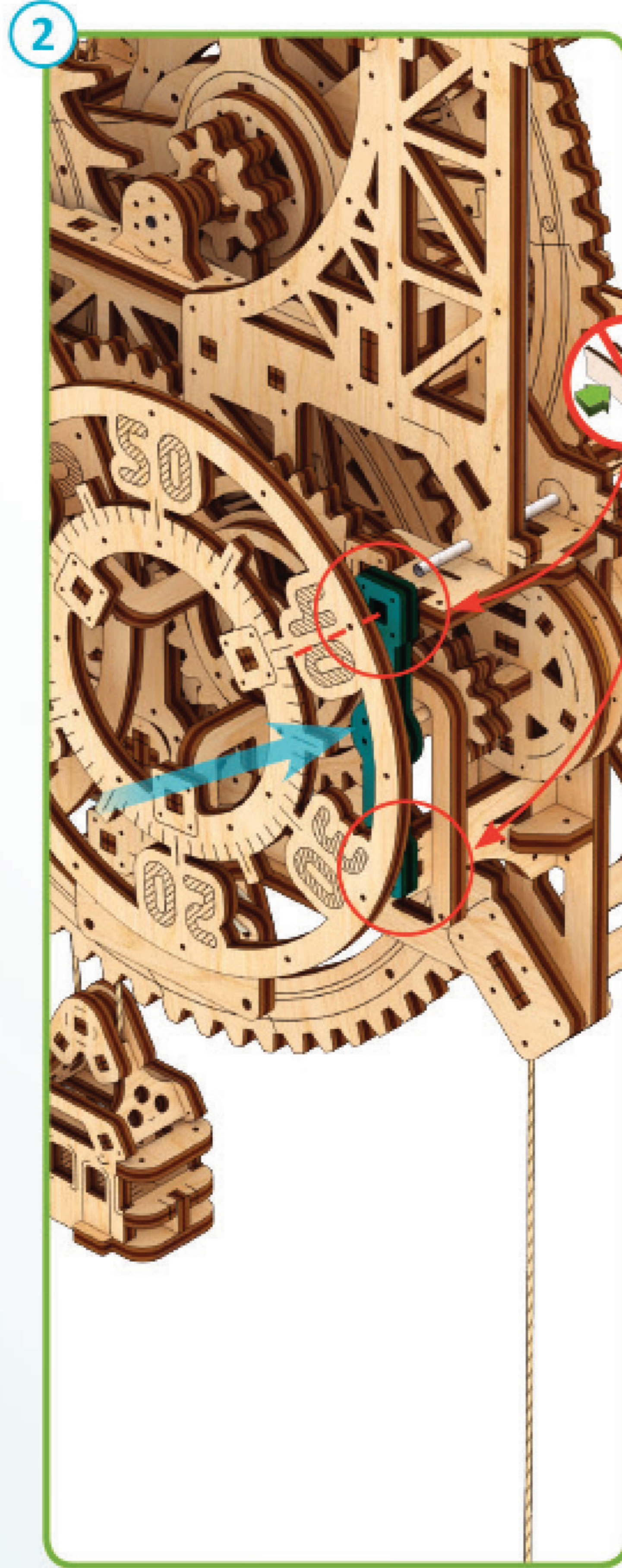
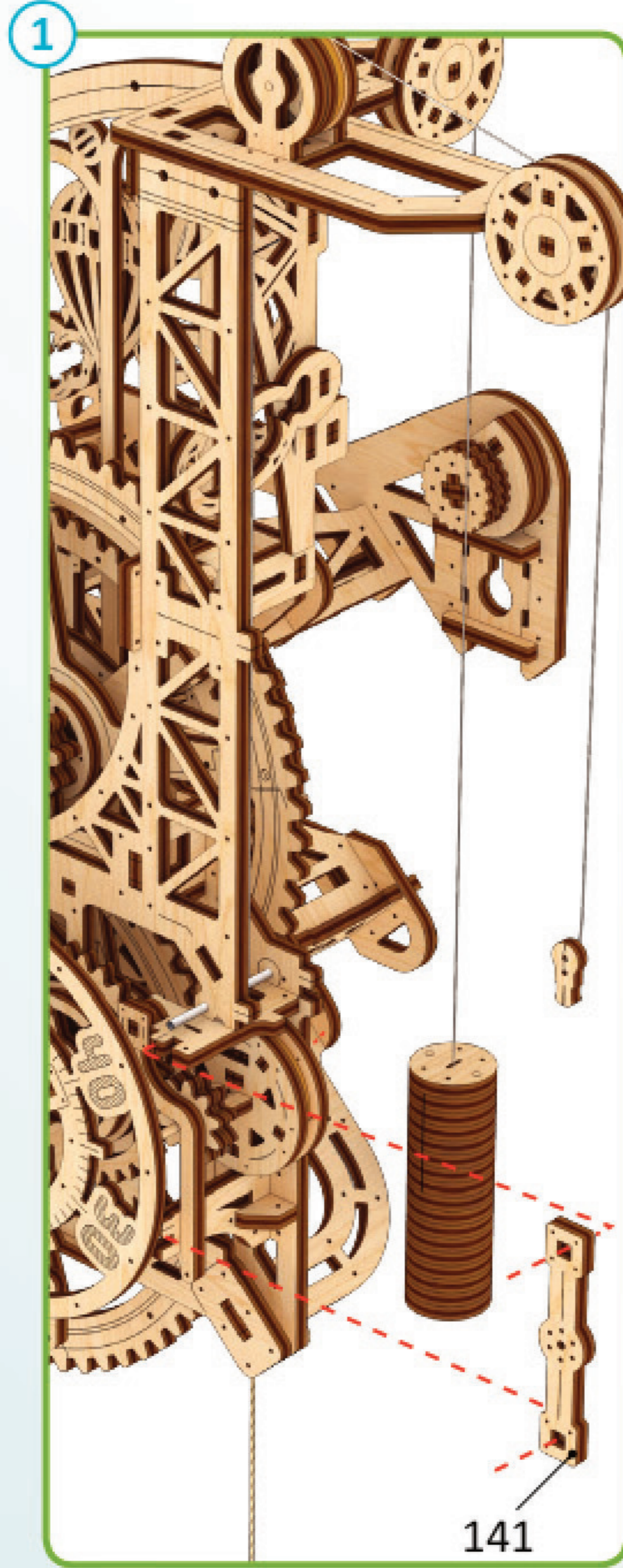



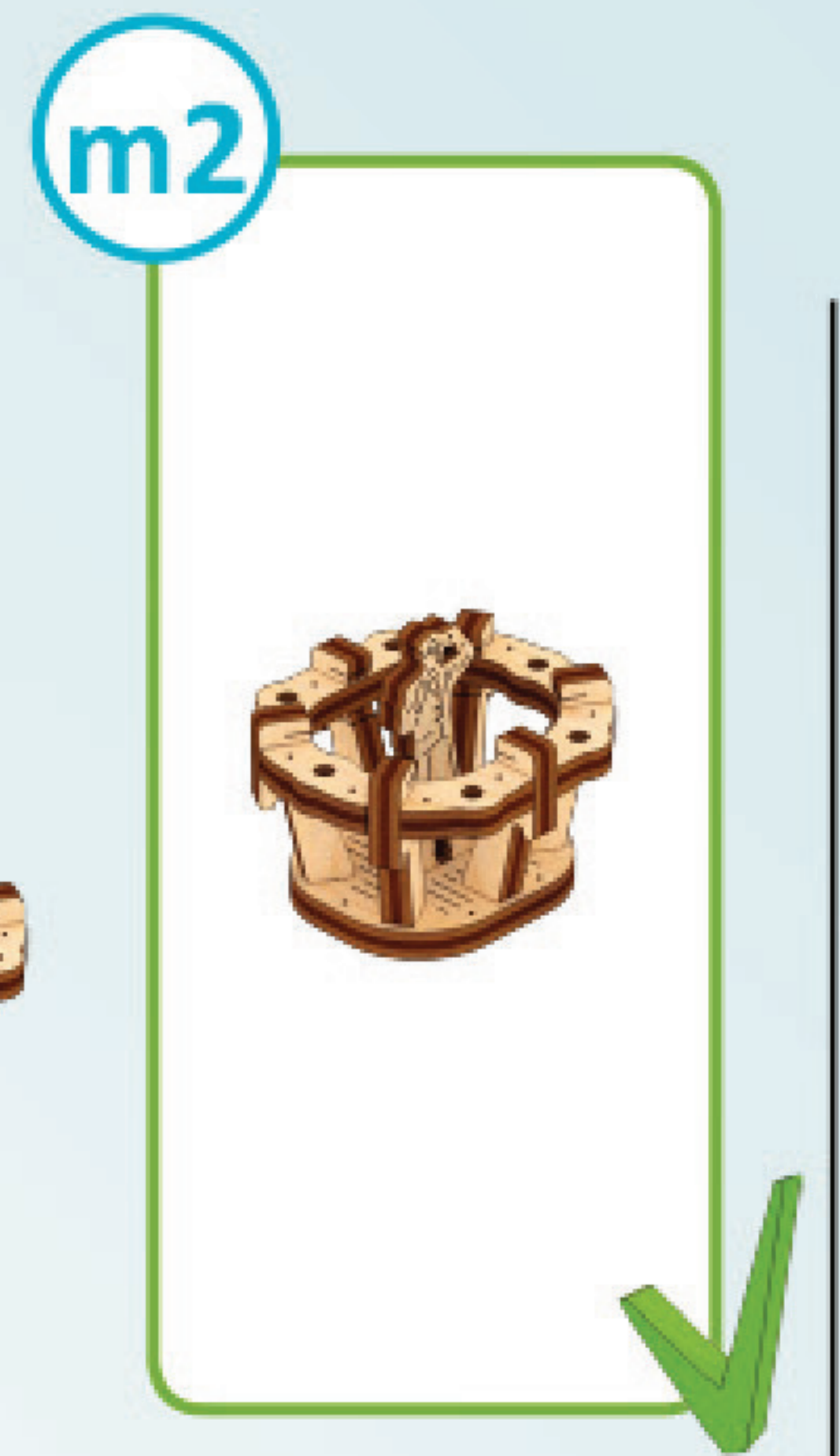
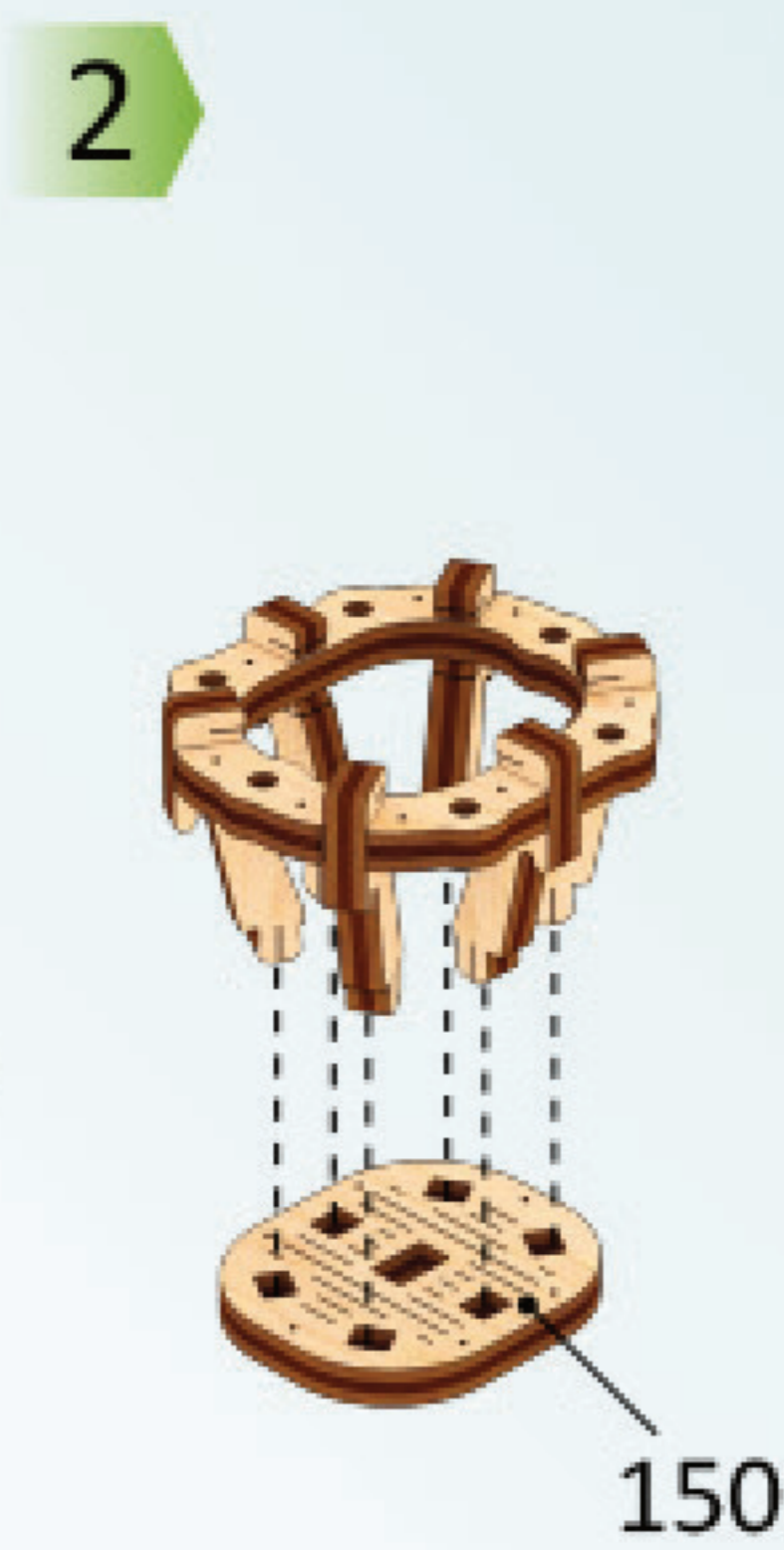
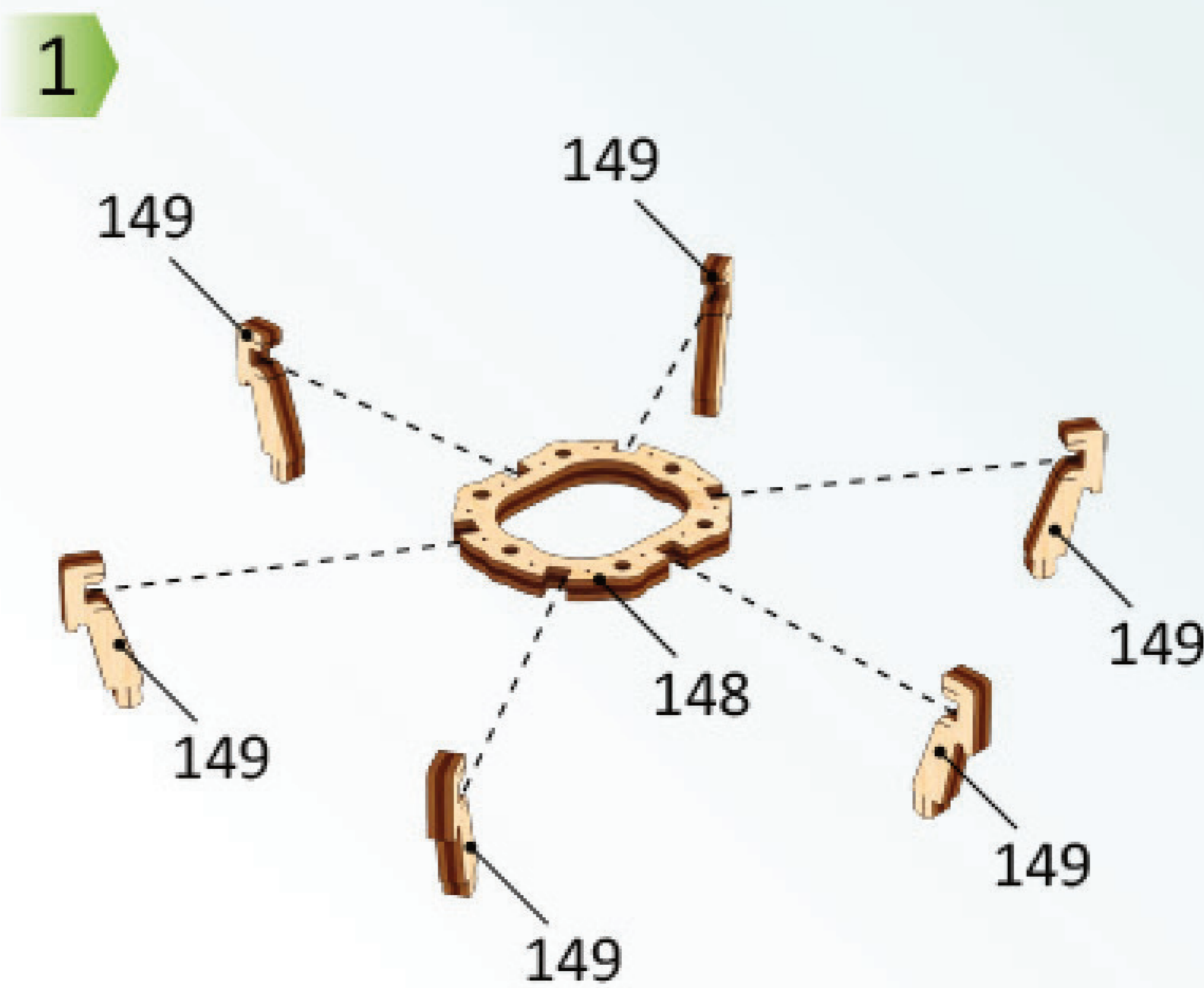
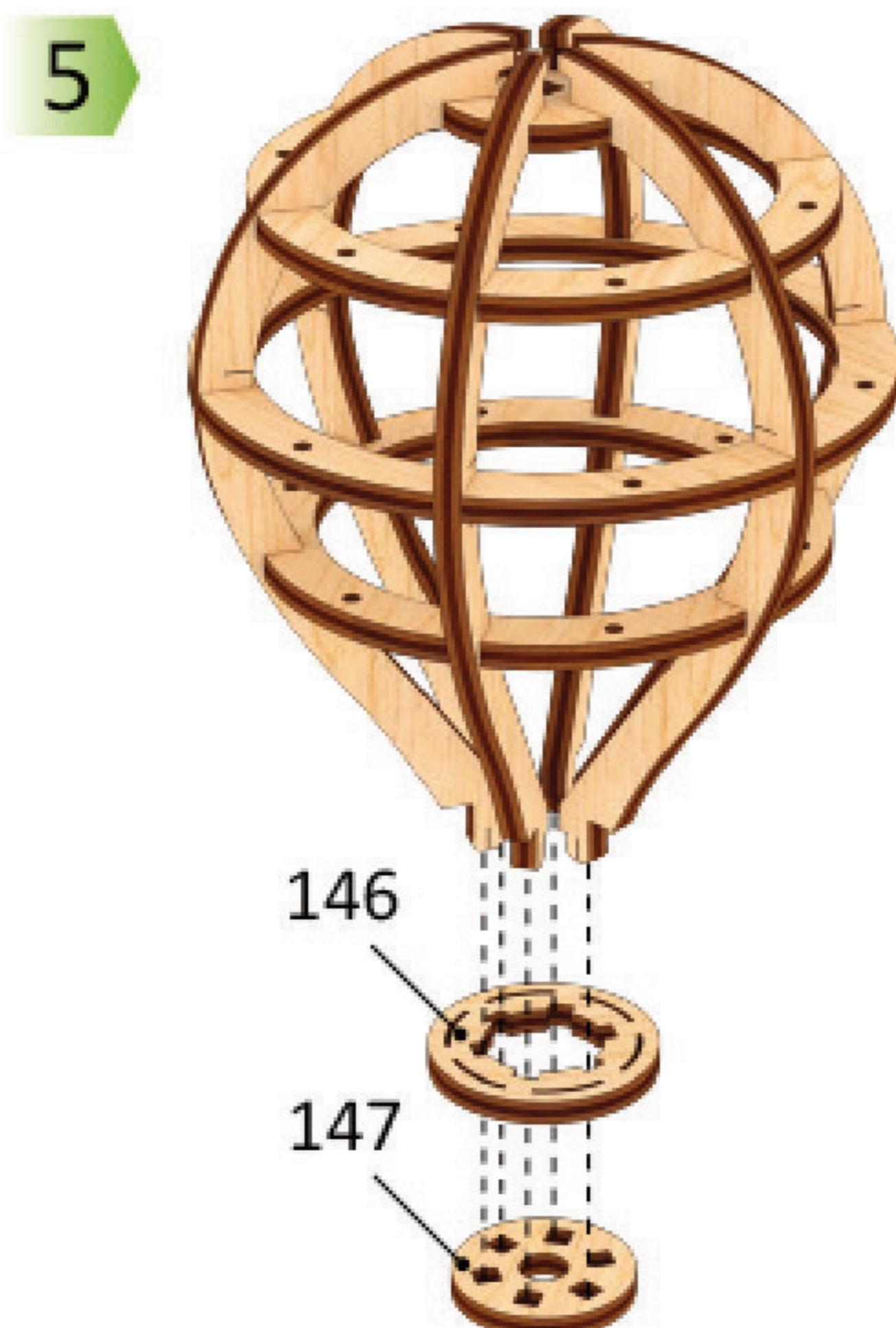
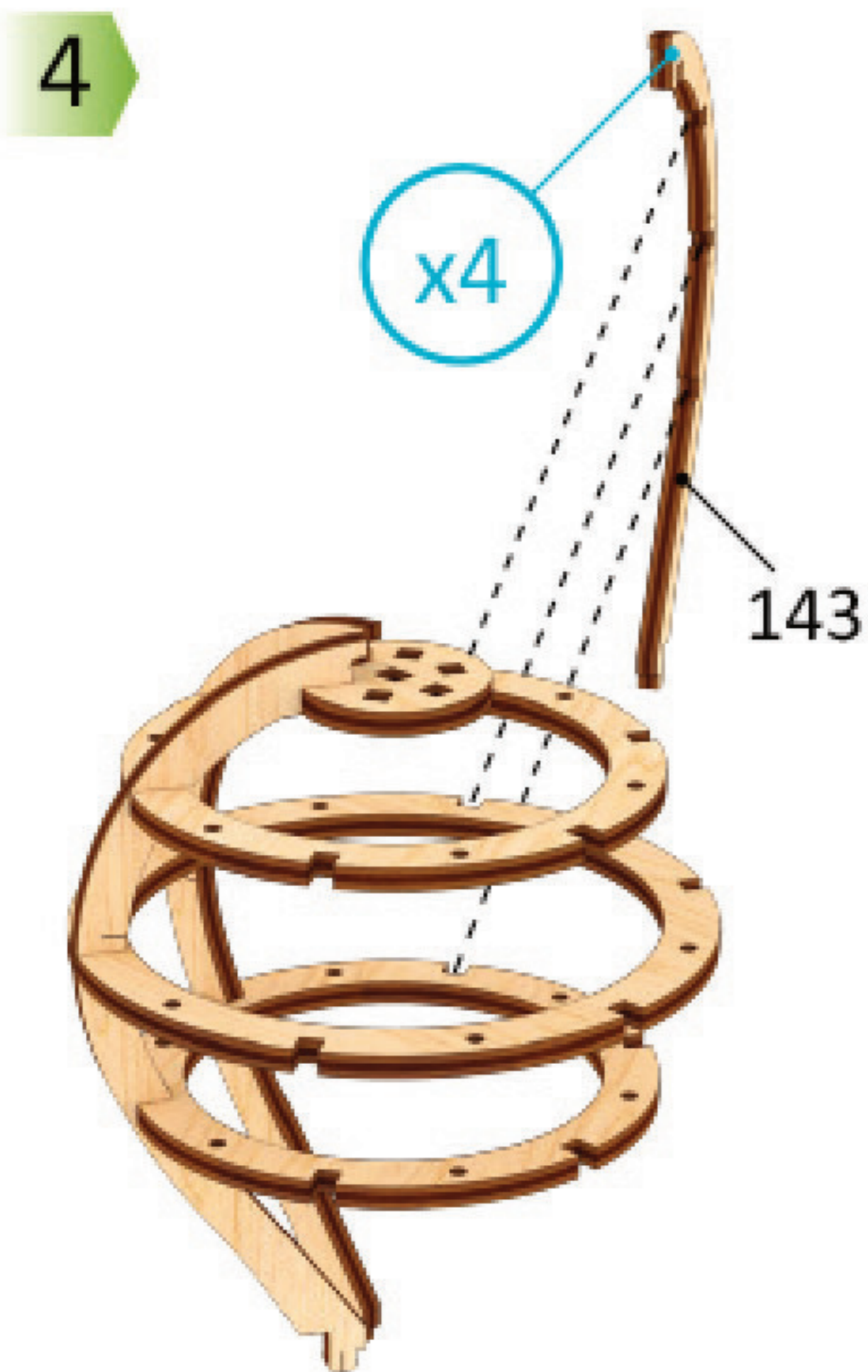
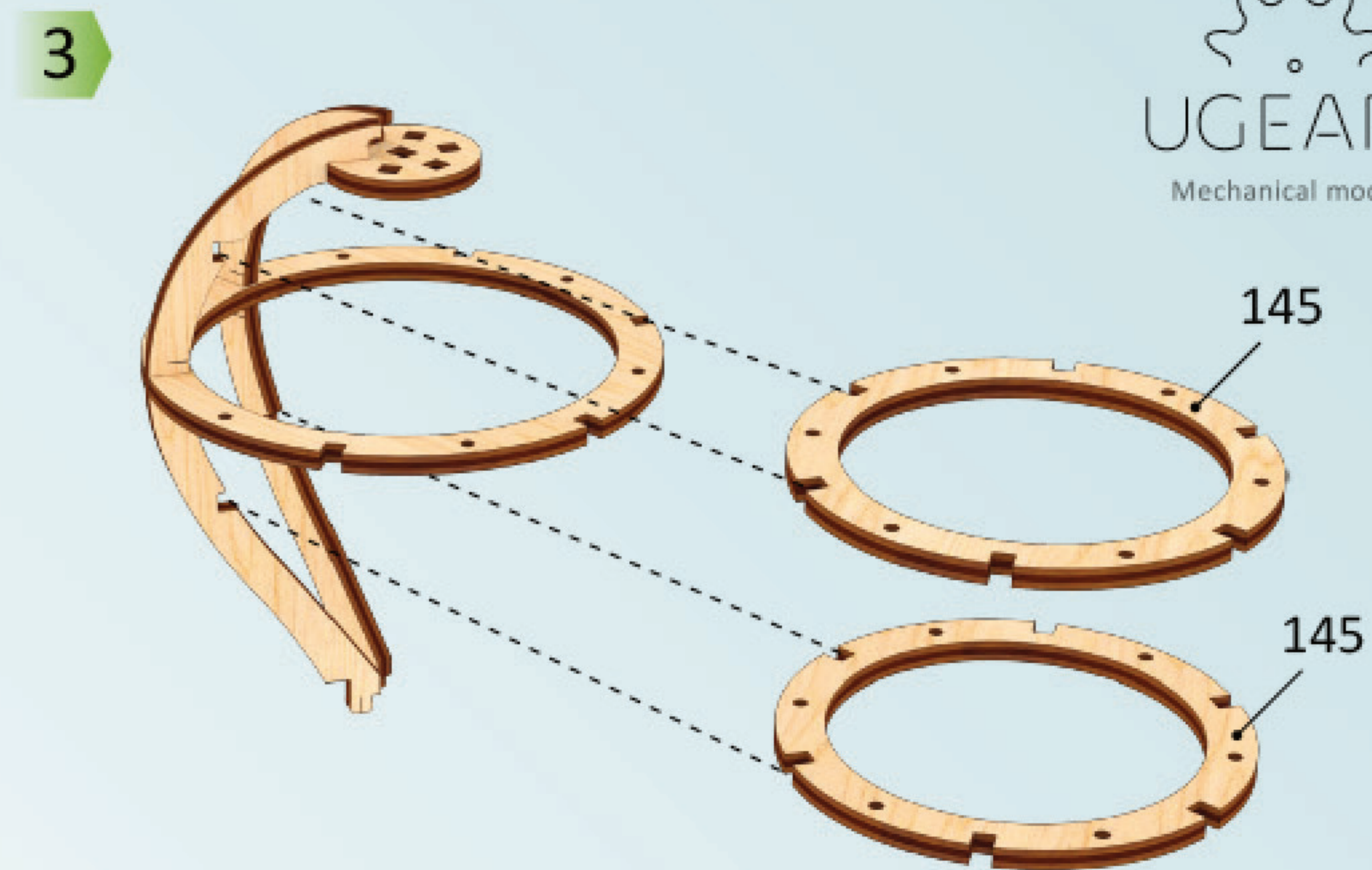
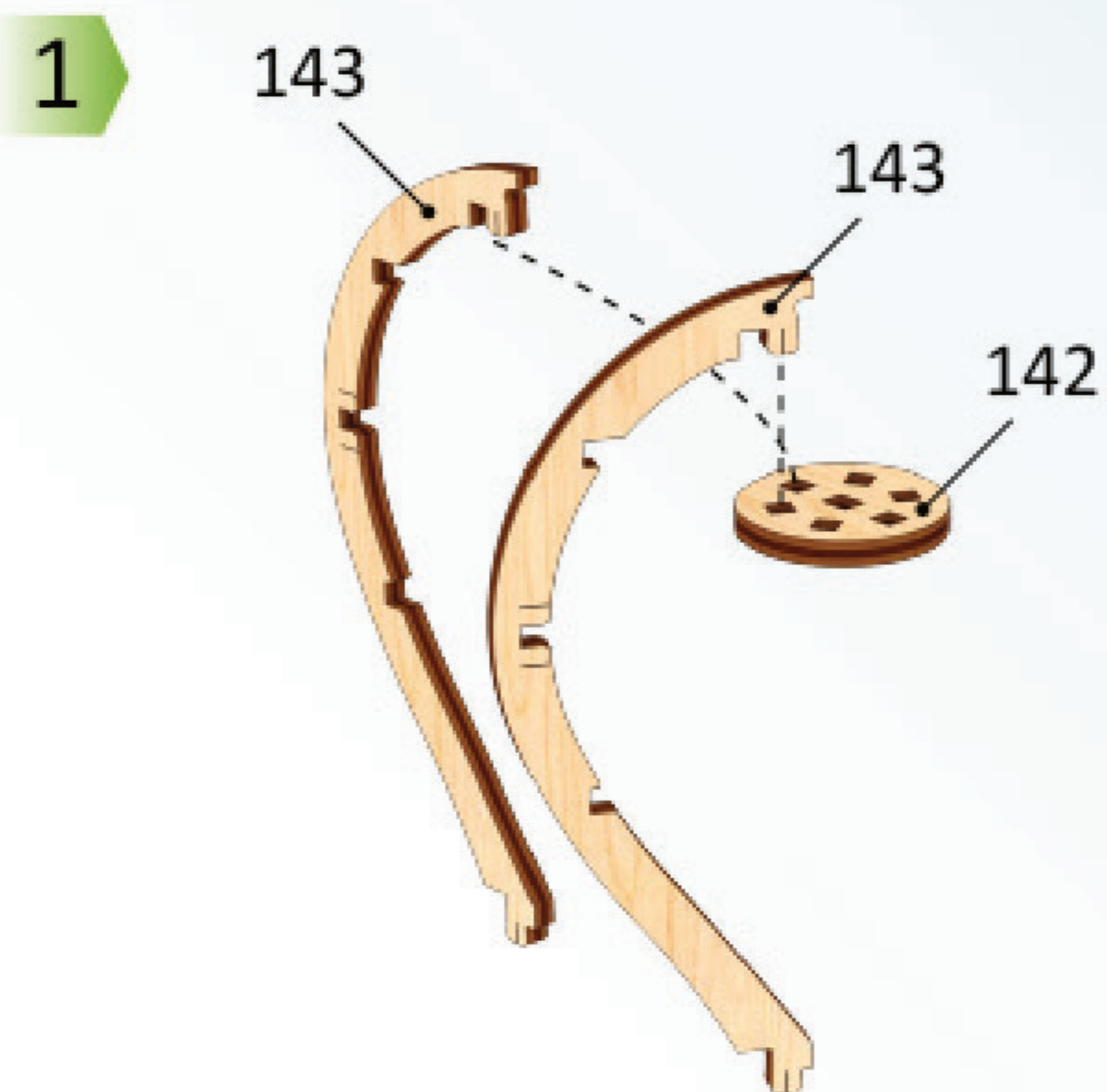
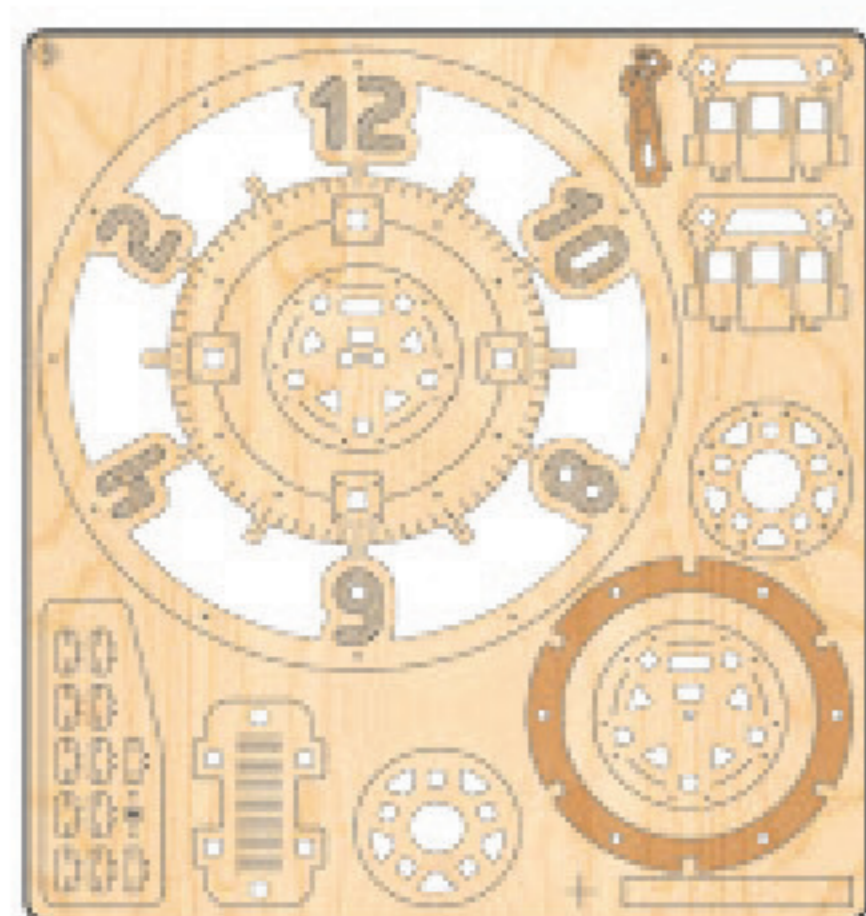
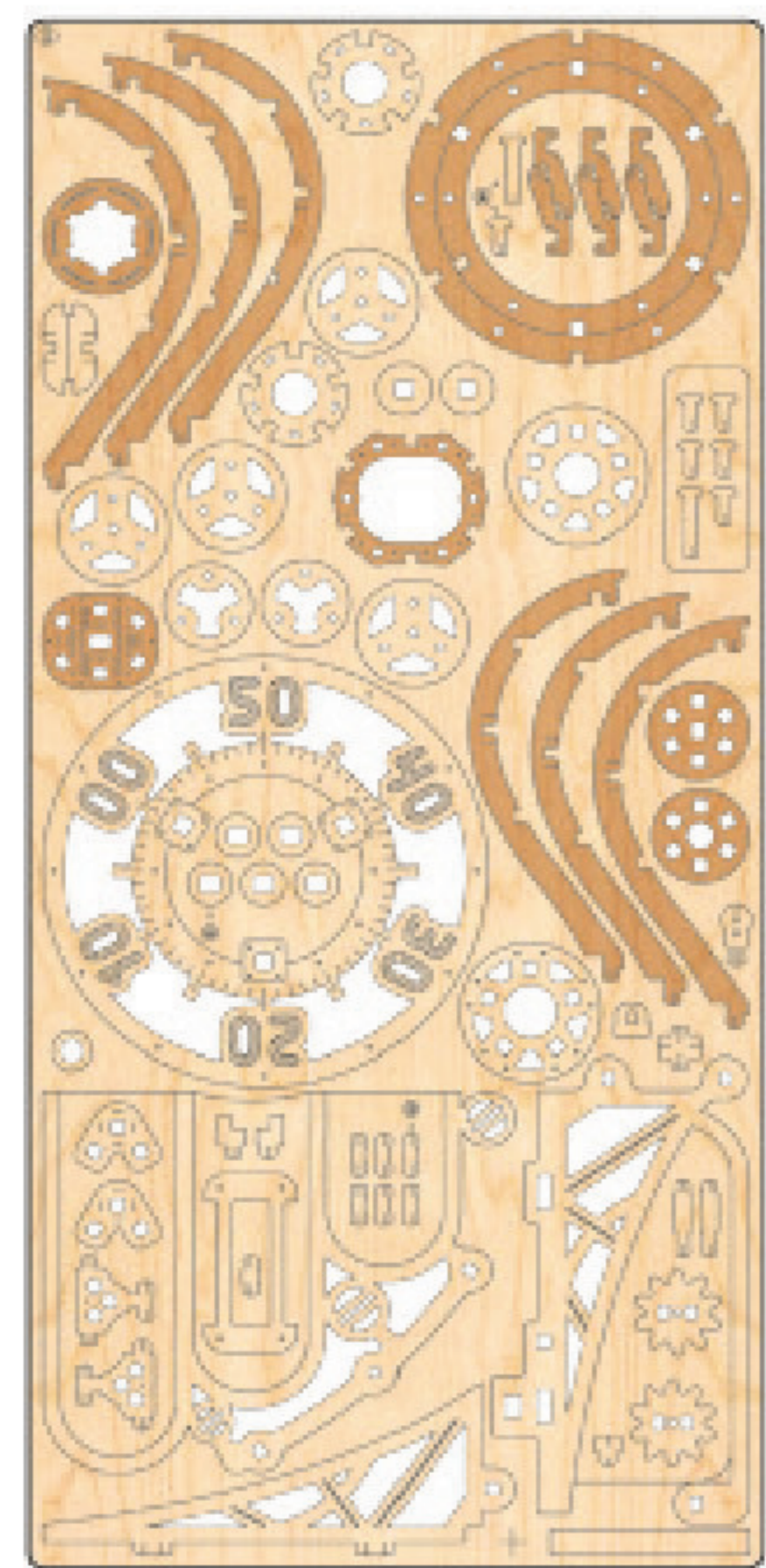

1



Nylon thread



l ≈ 39.4" / 1000 mm

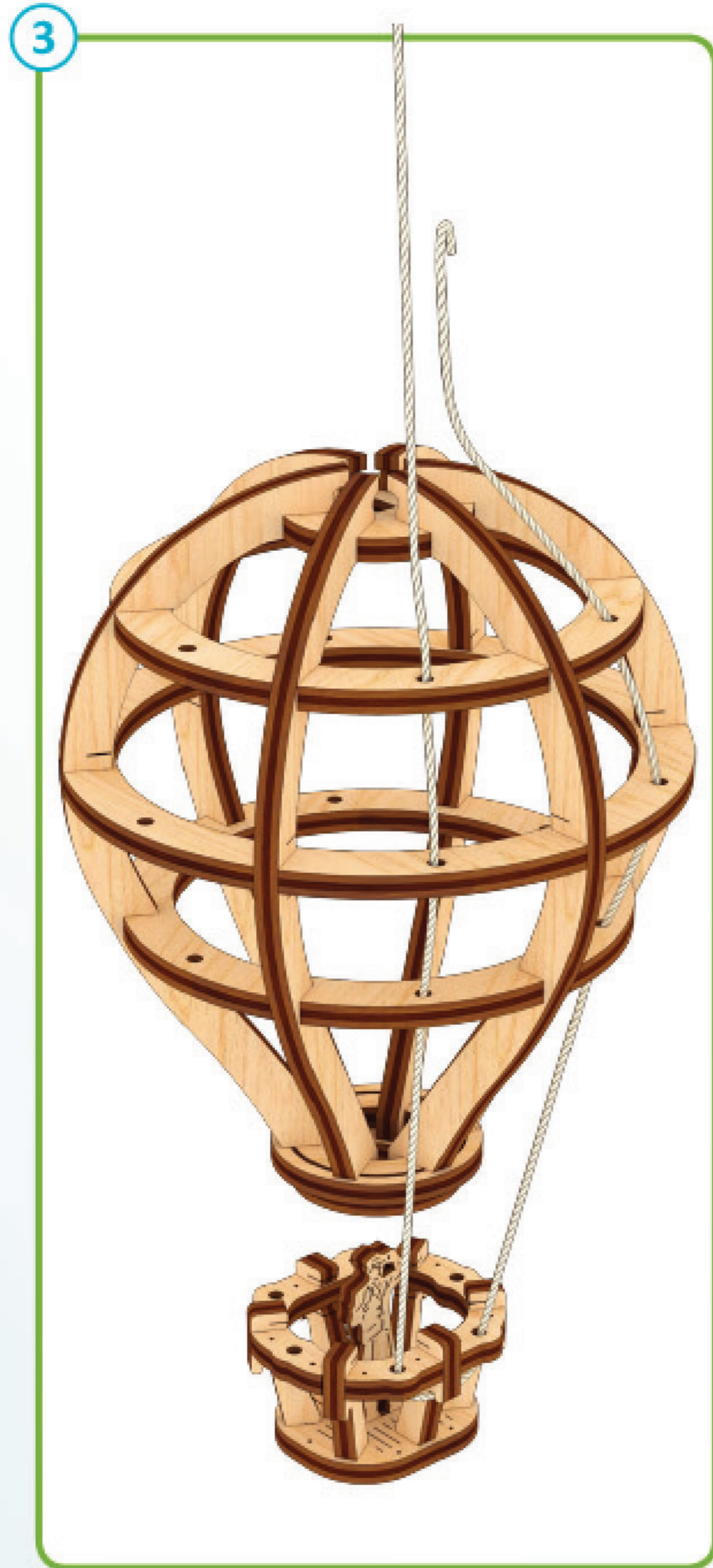
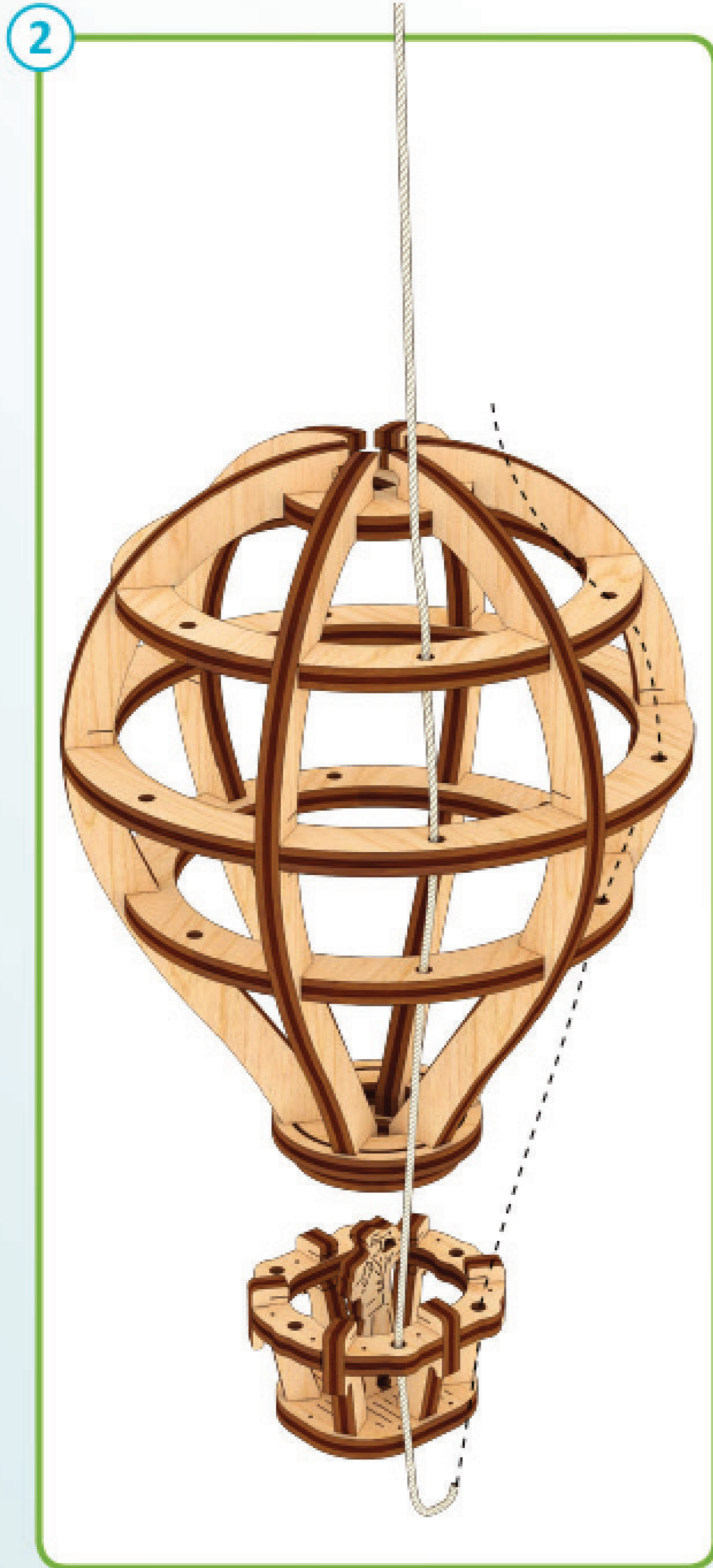
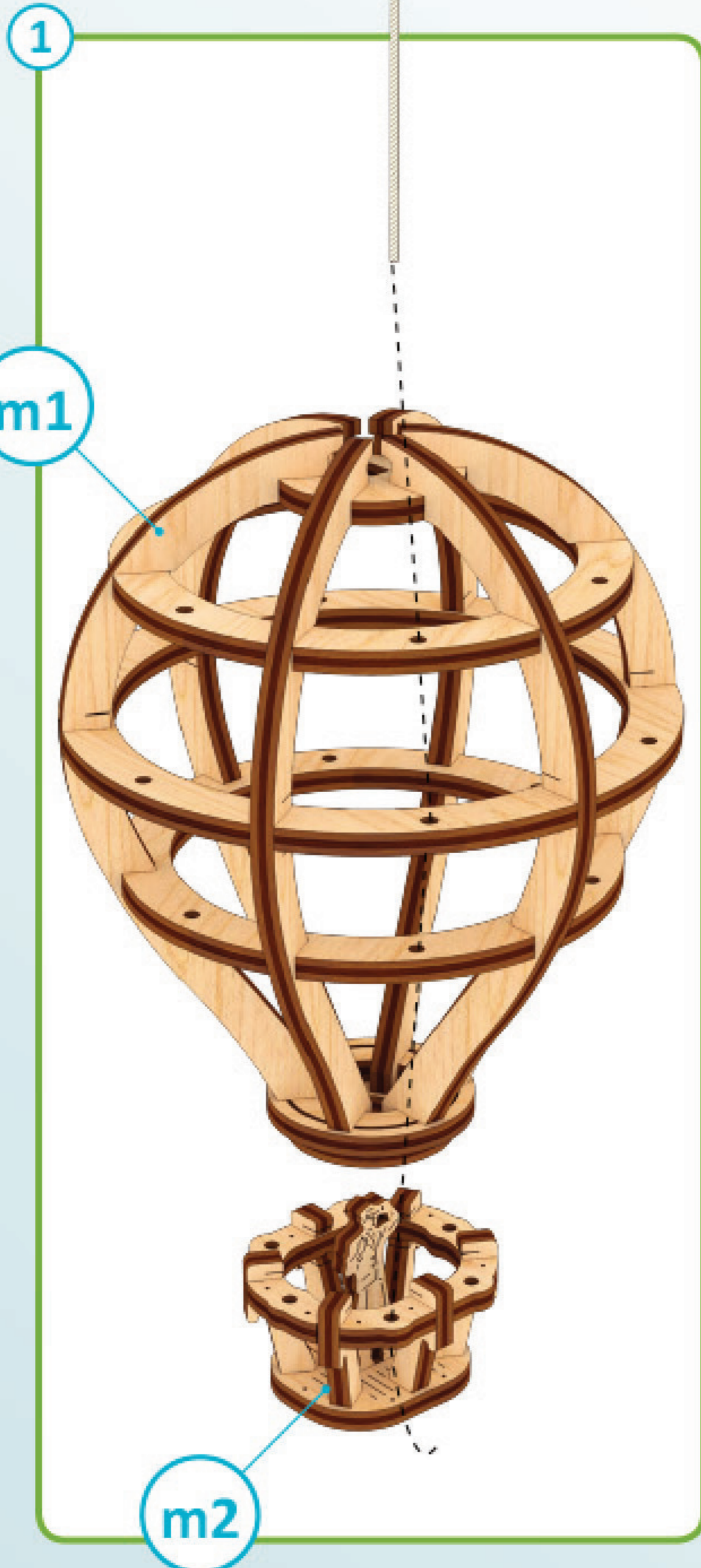

5

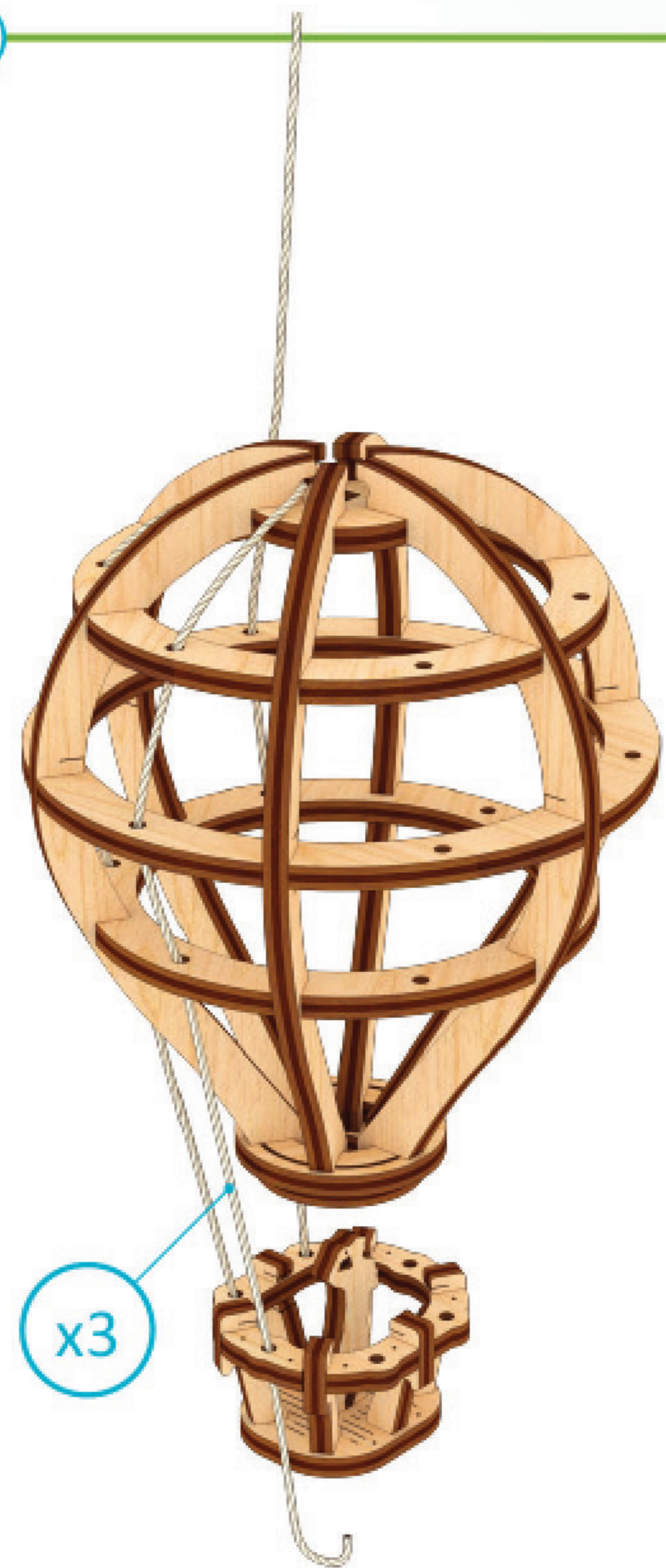

6

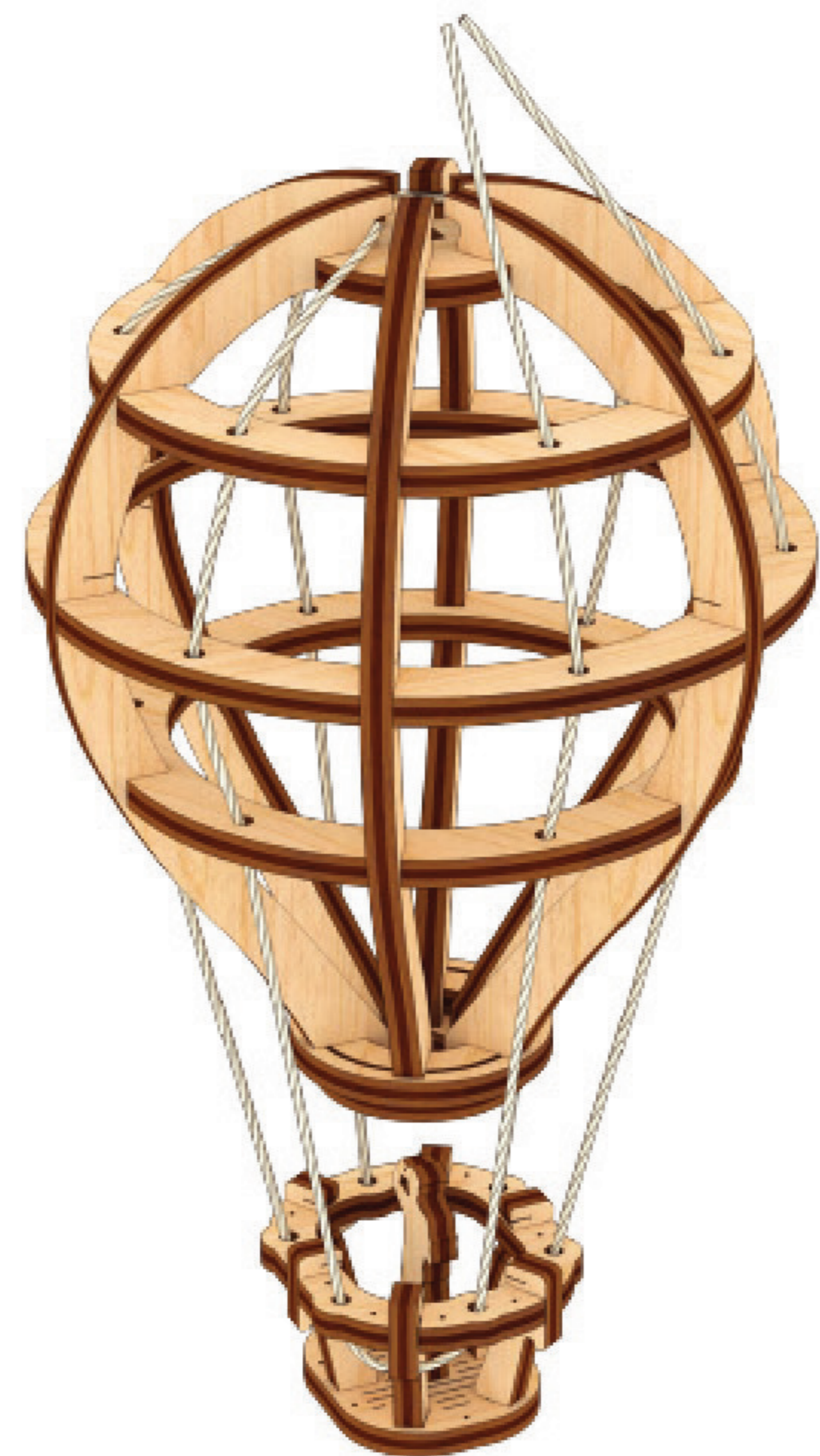

7

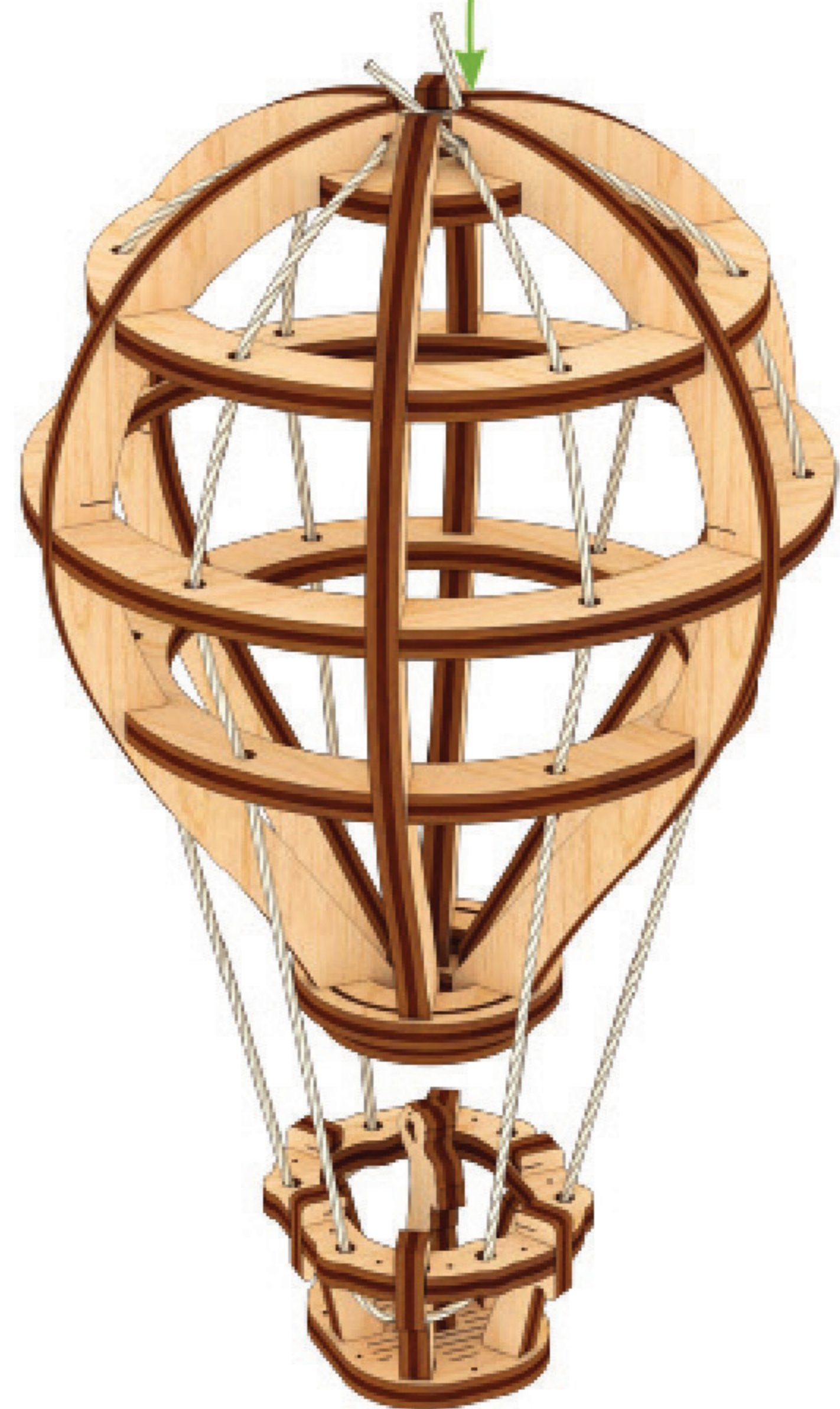

M

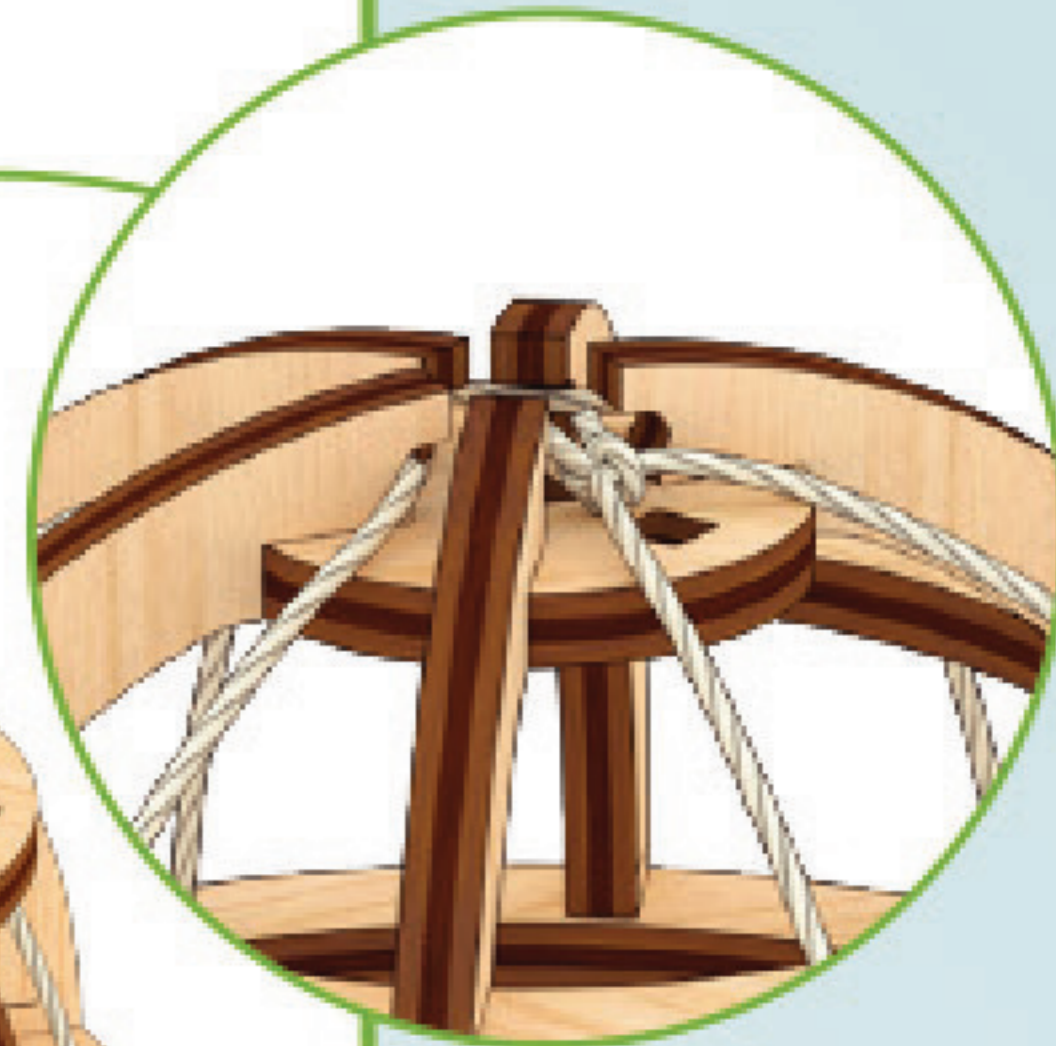
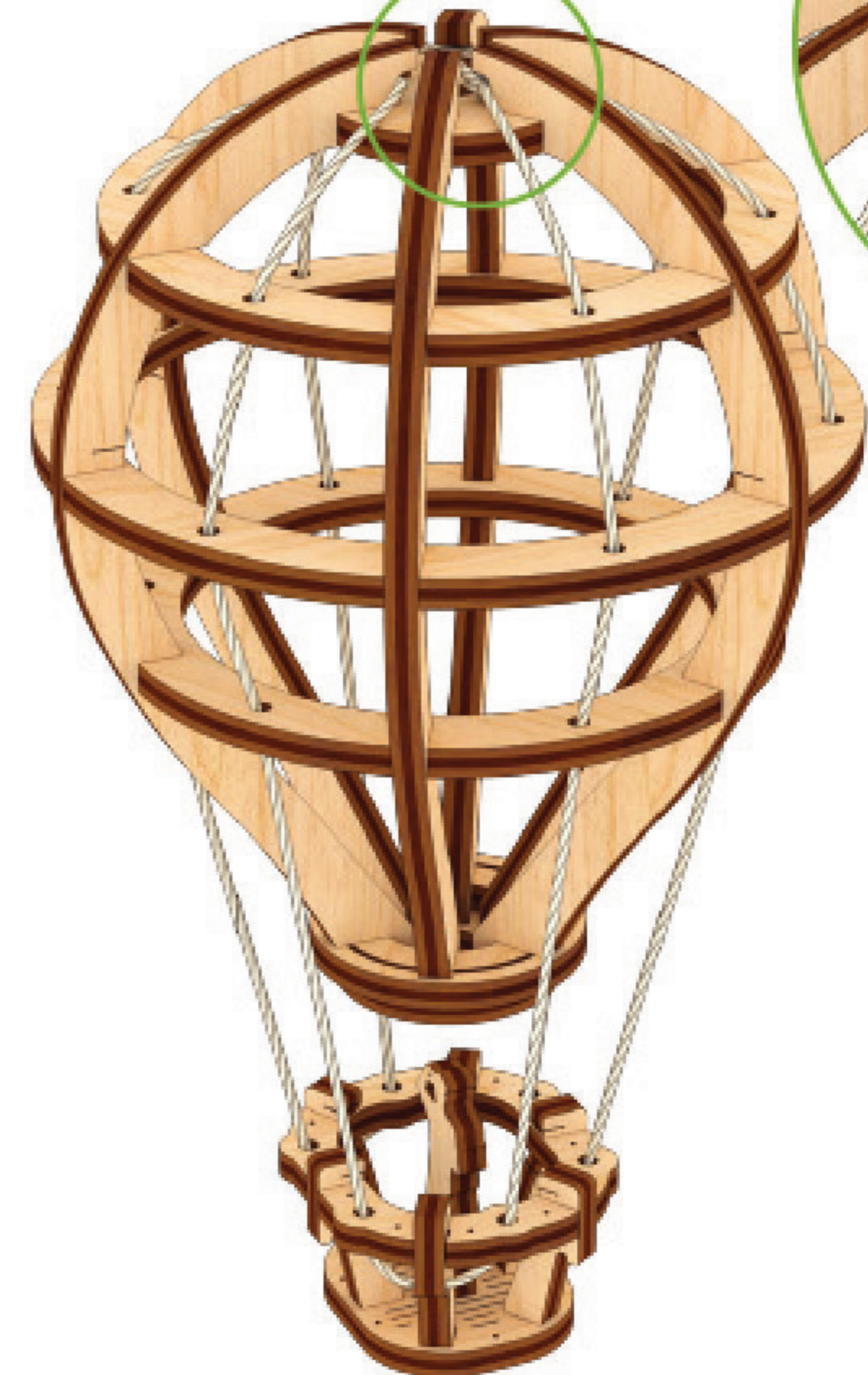

1

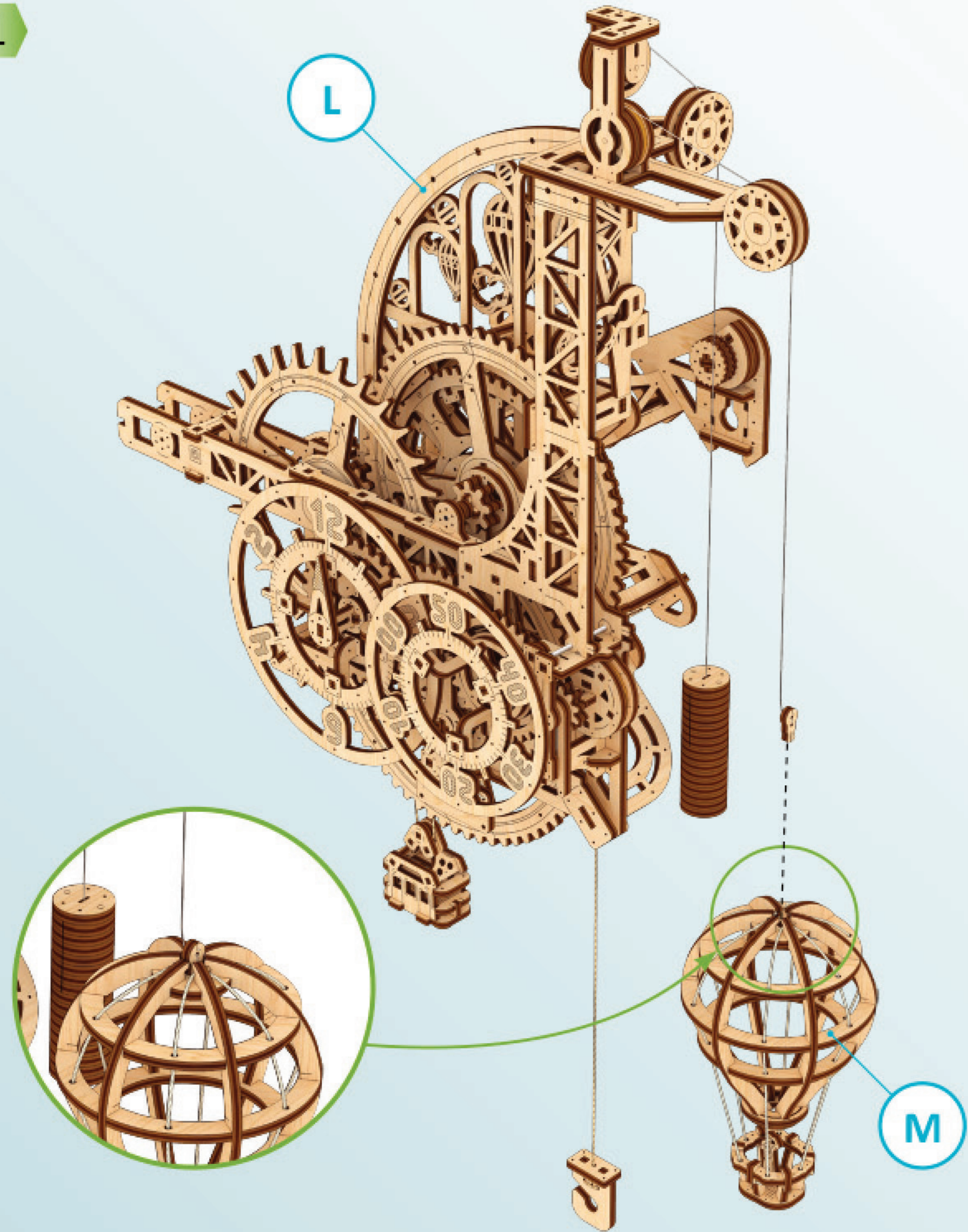

2

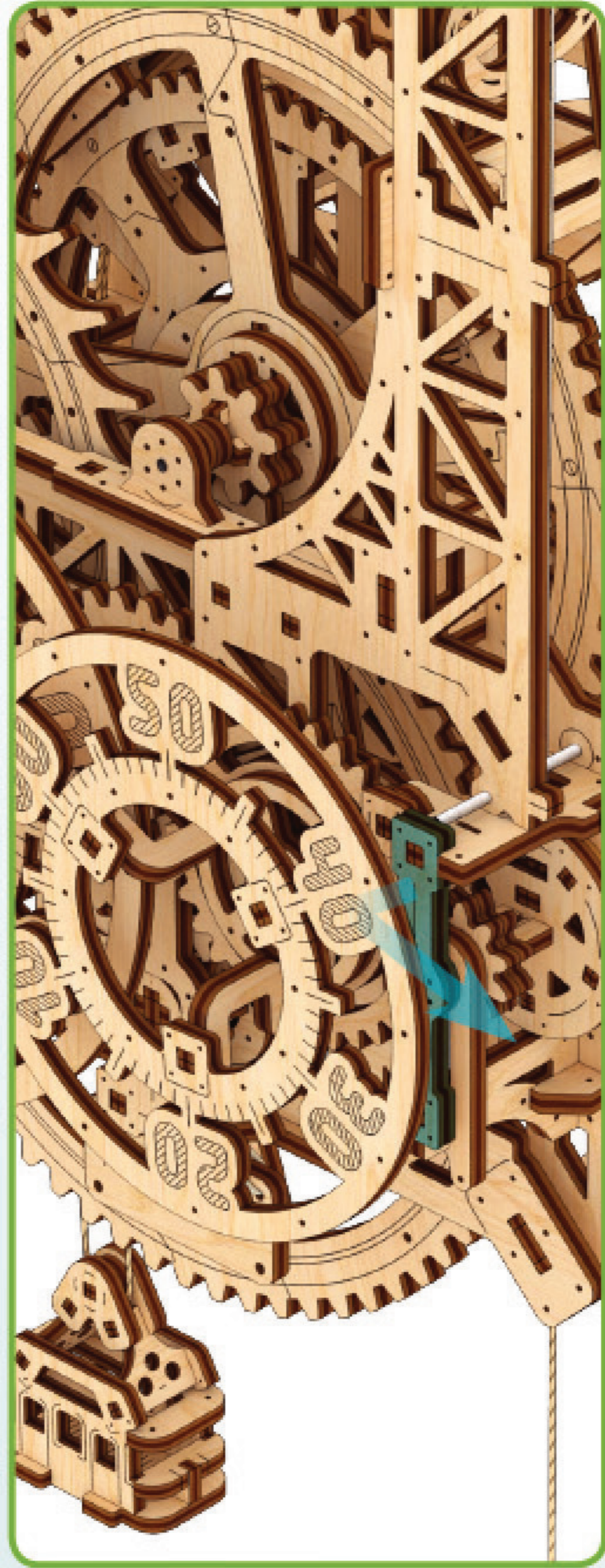

3

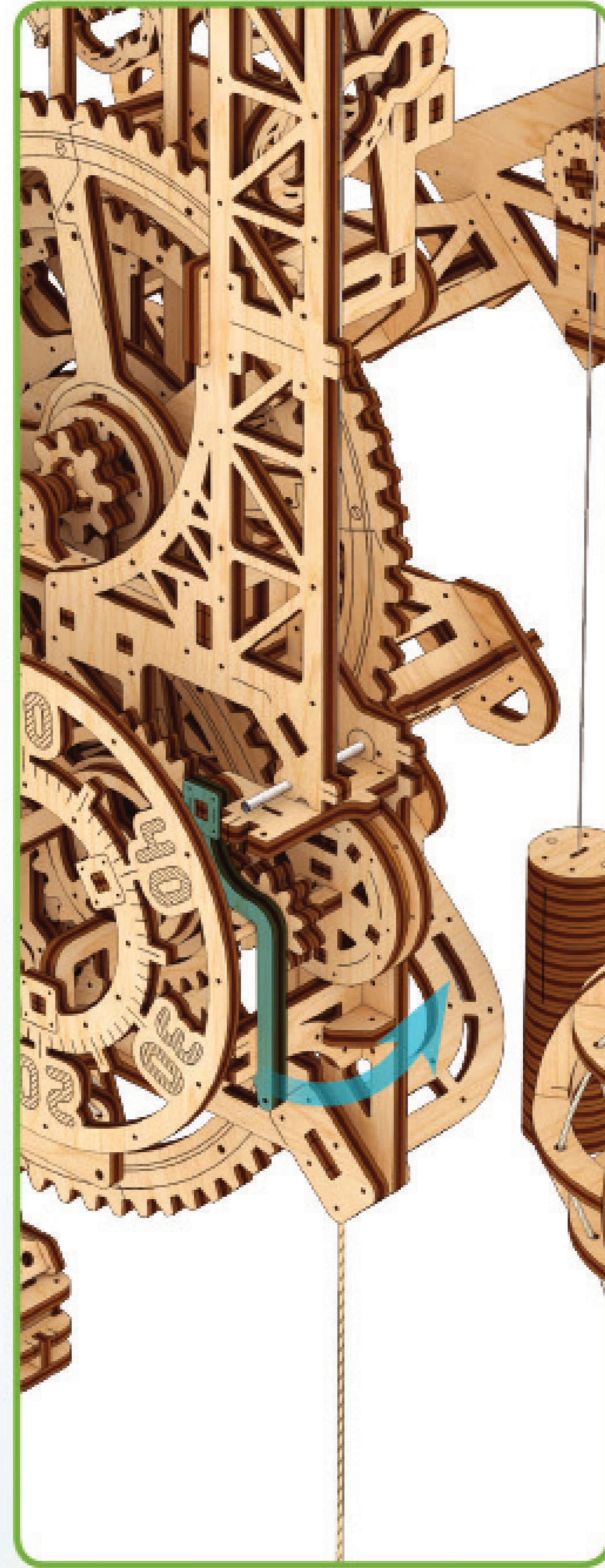

4

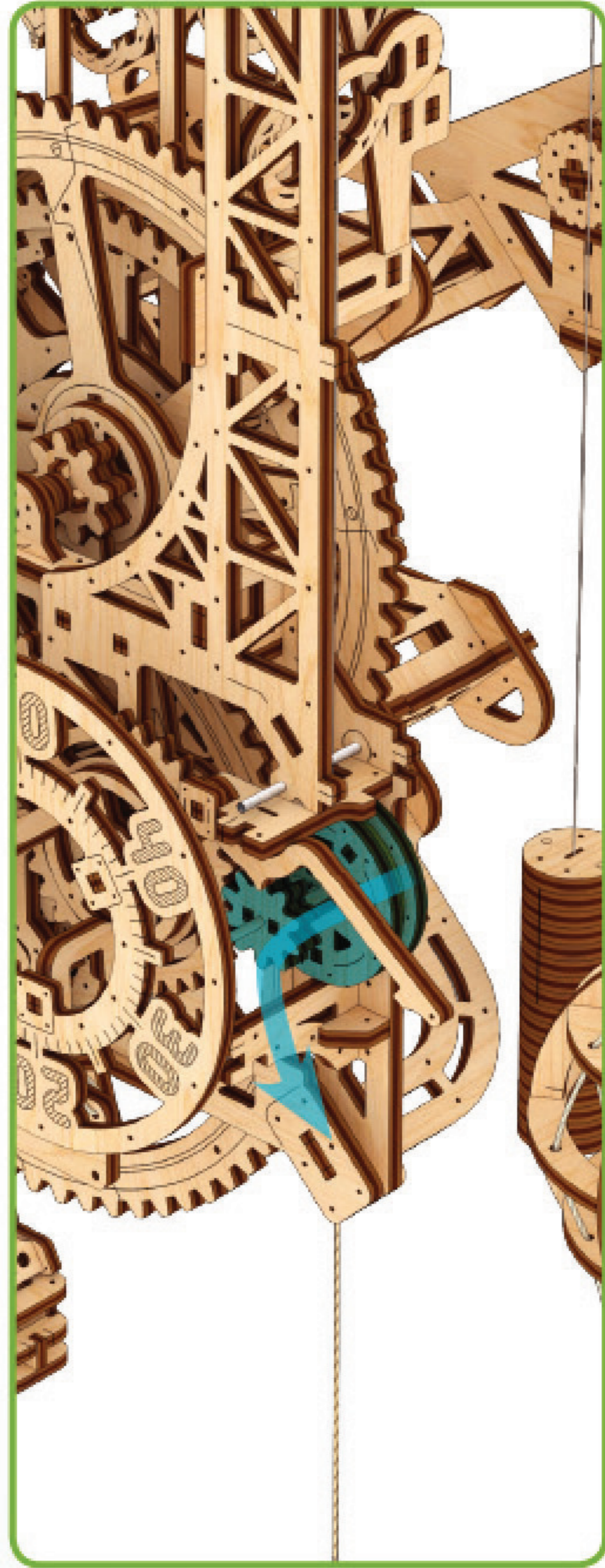

5

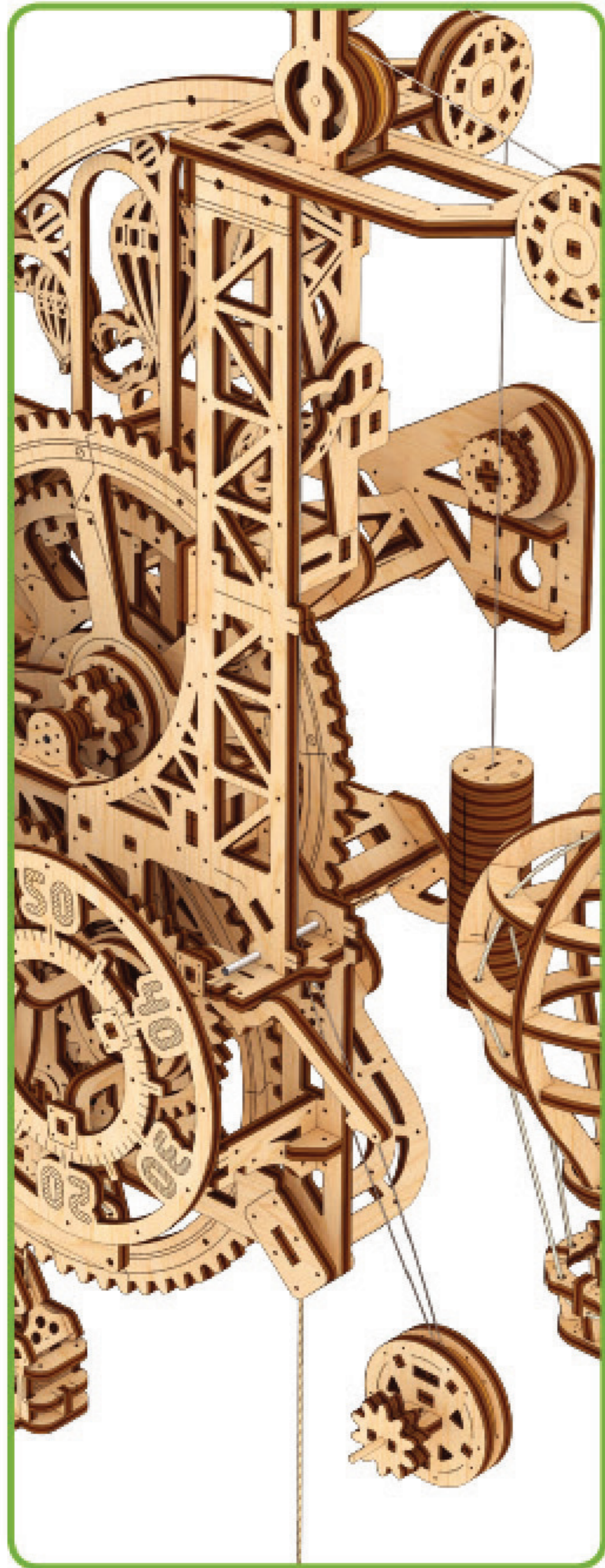

6

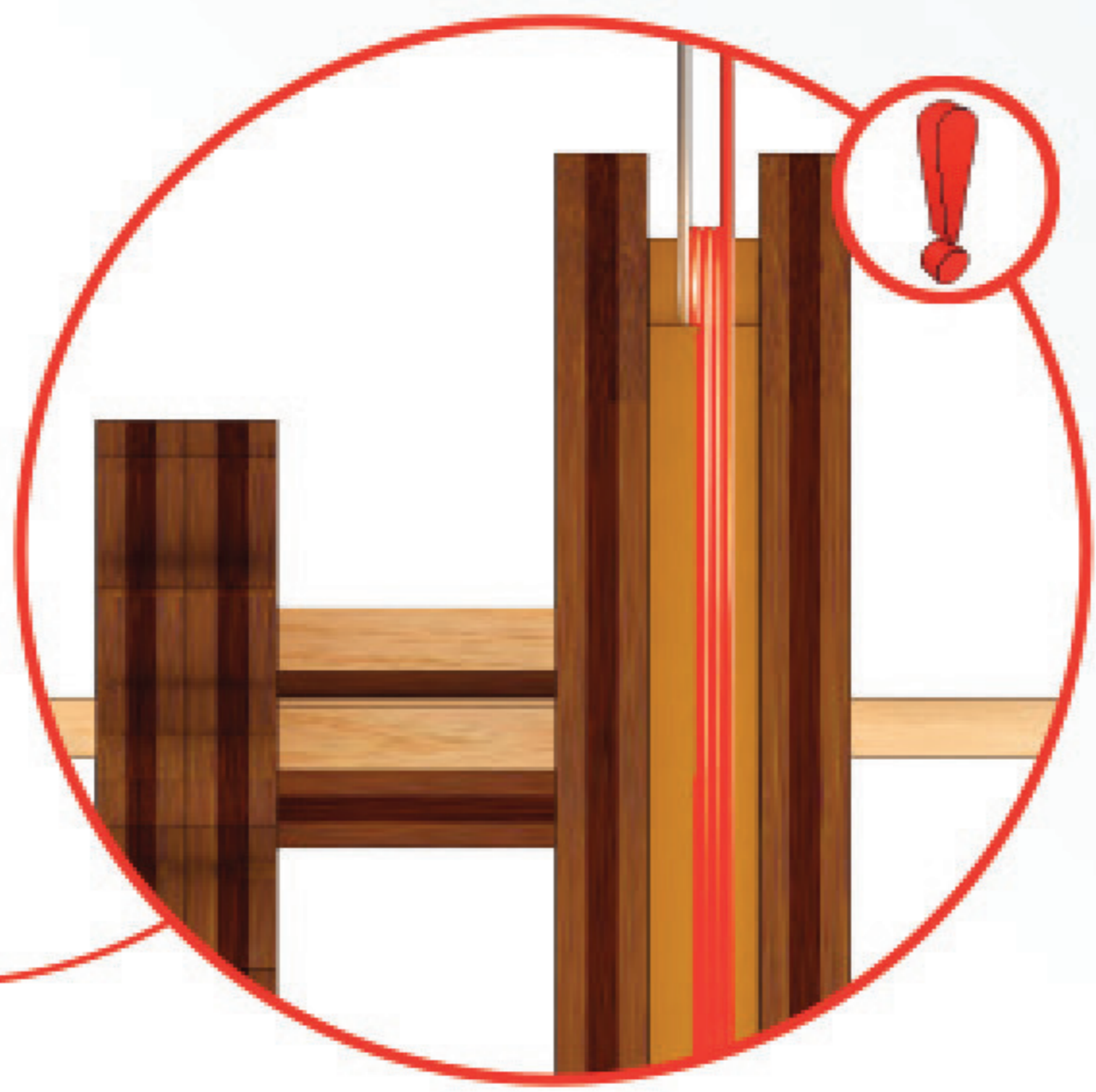
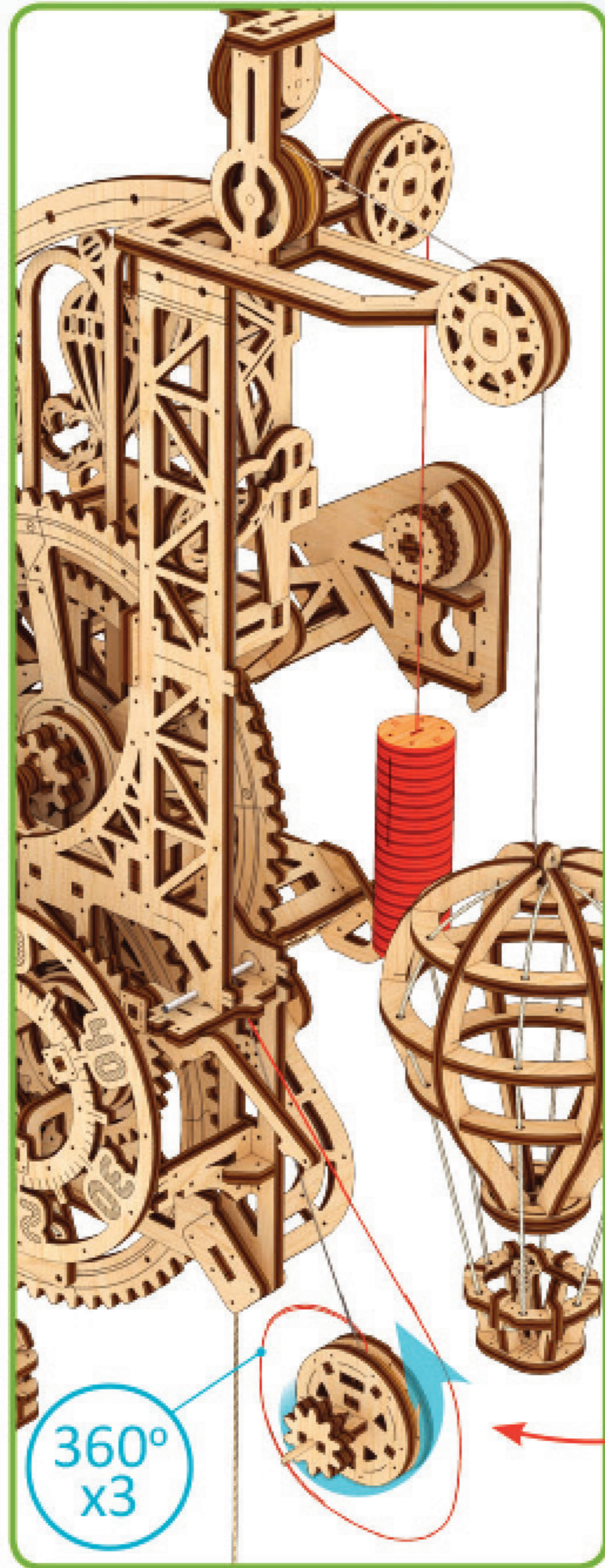

7



8

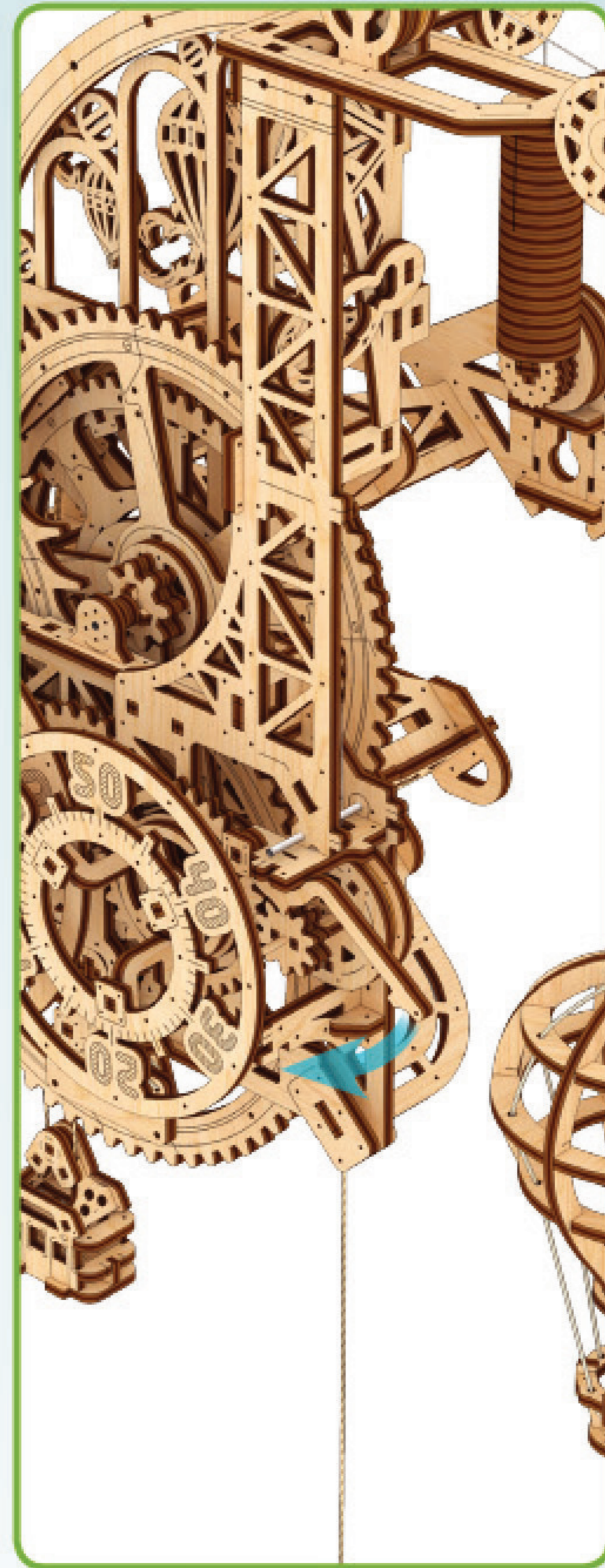

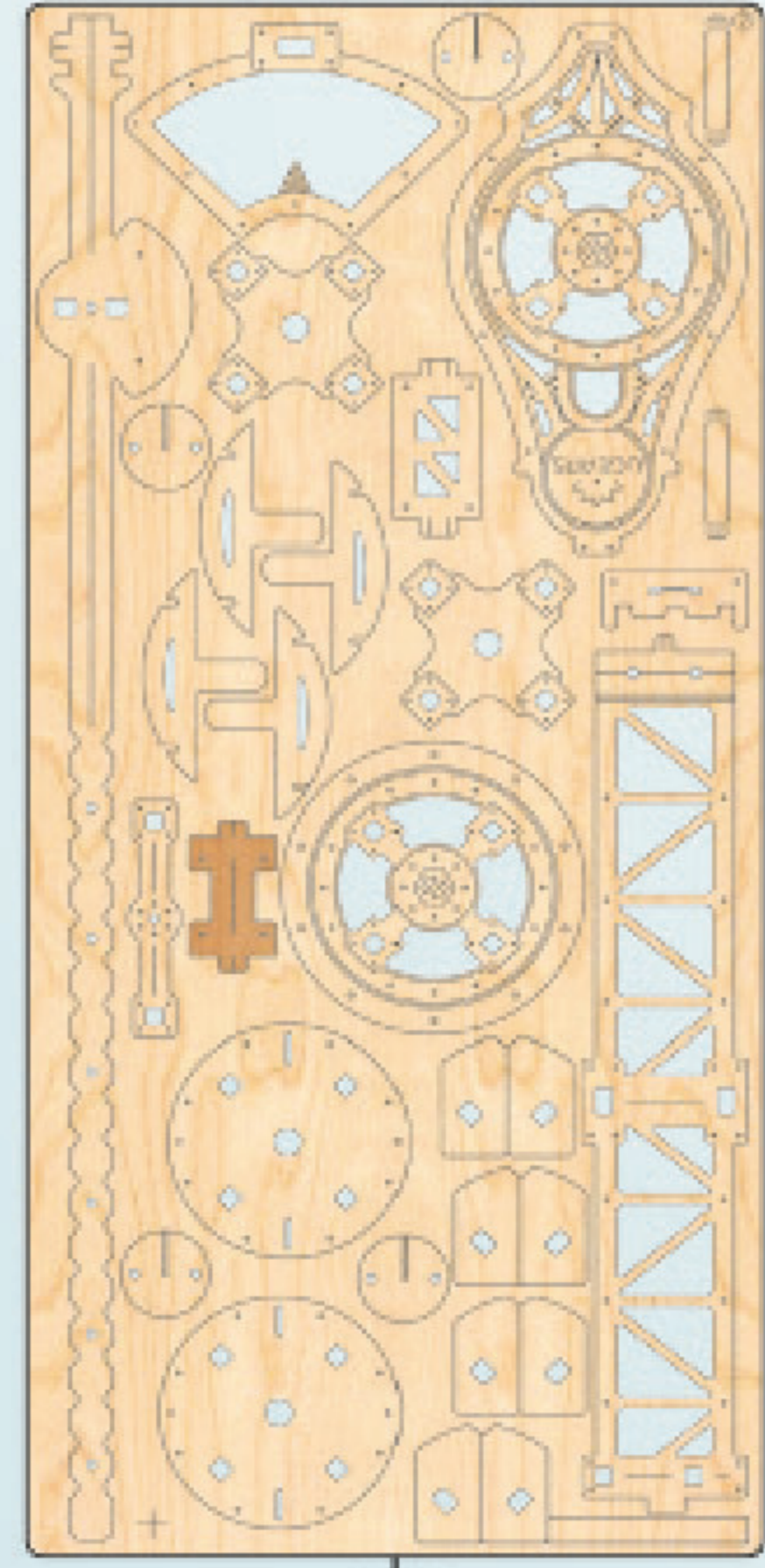

7

9

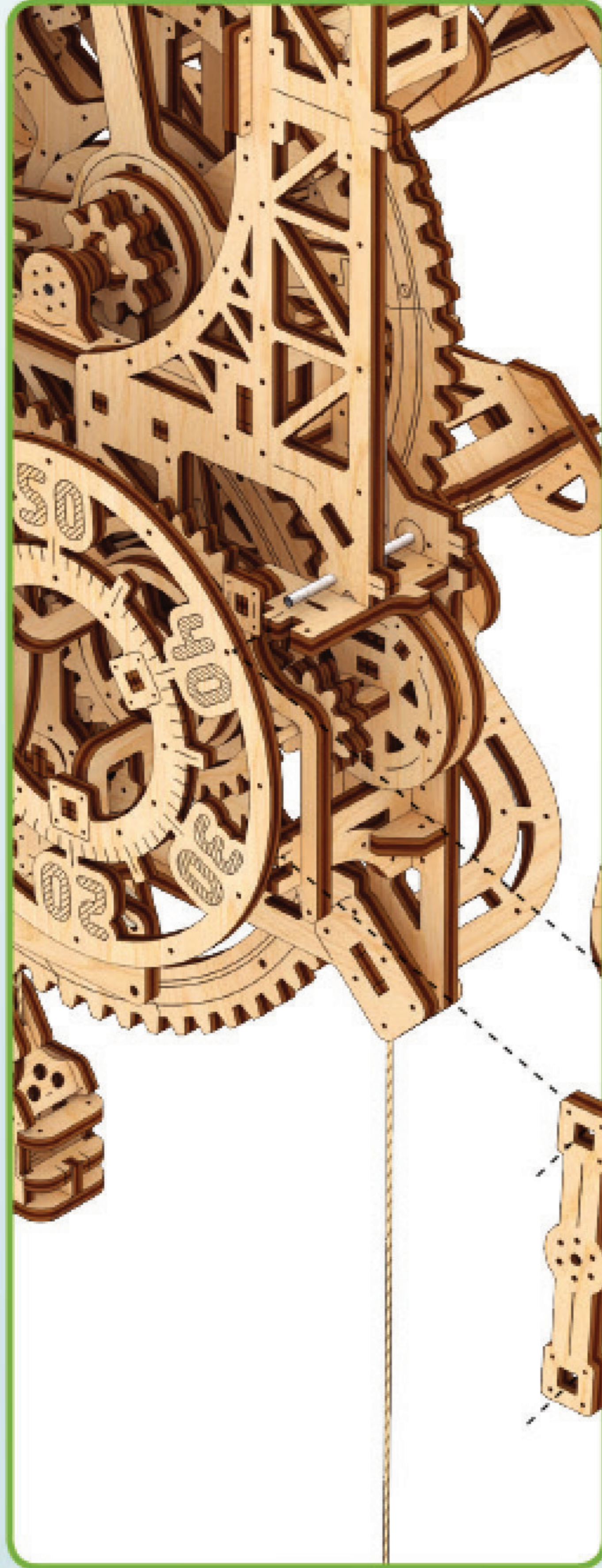

10

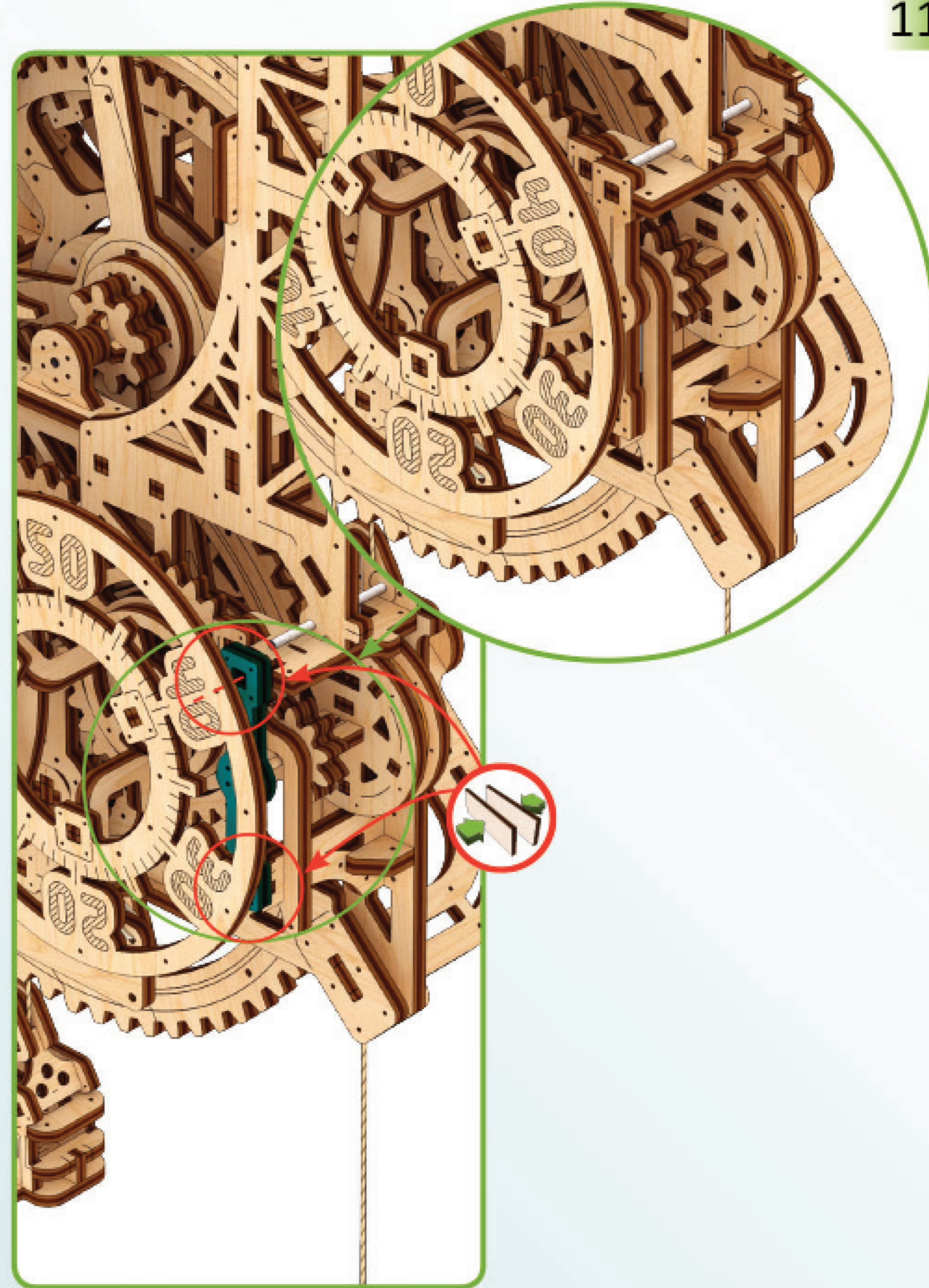

11

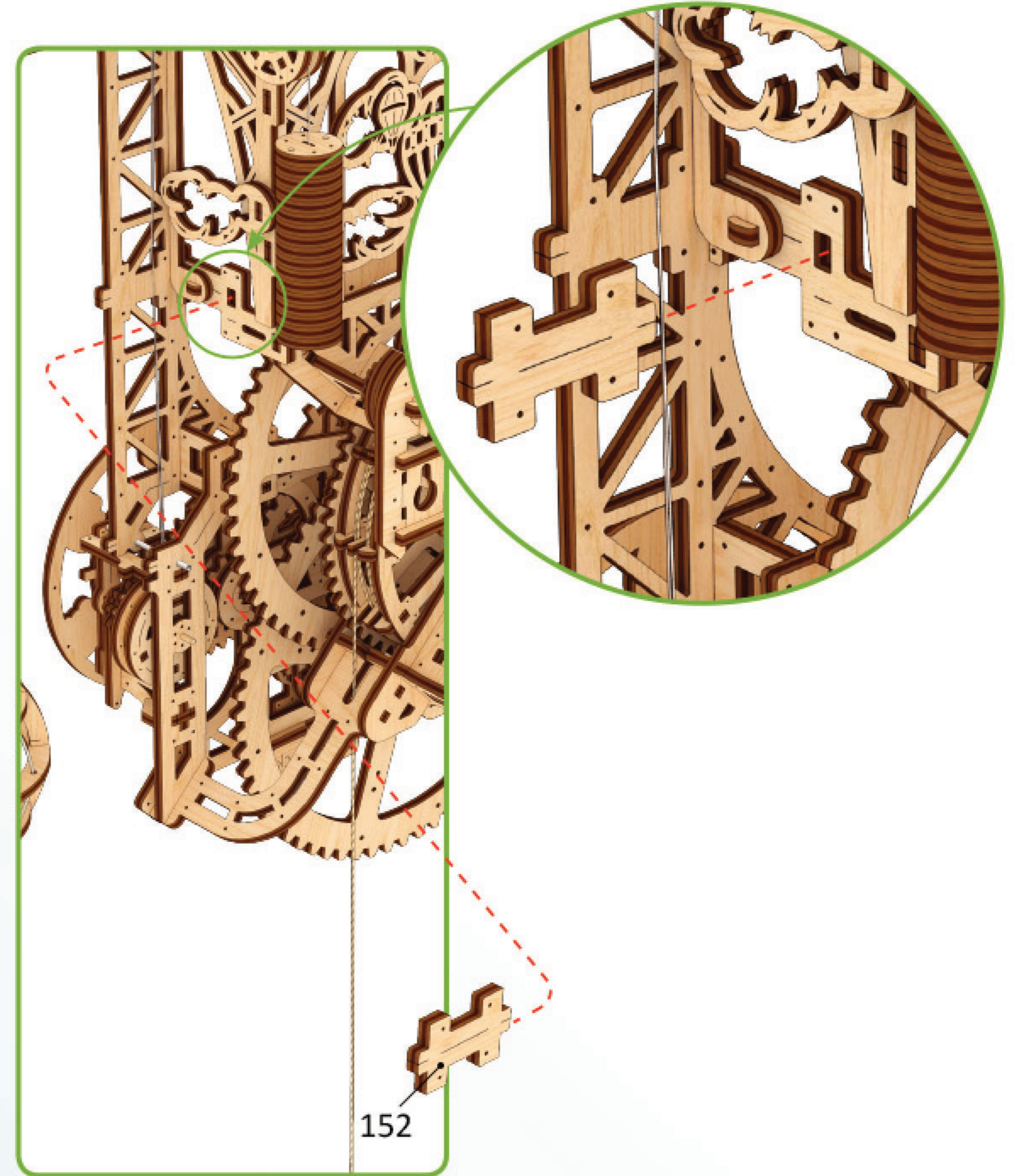

152

12

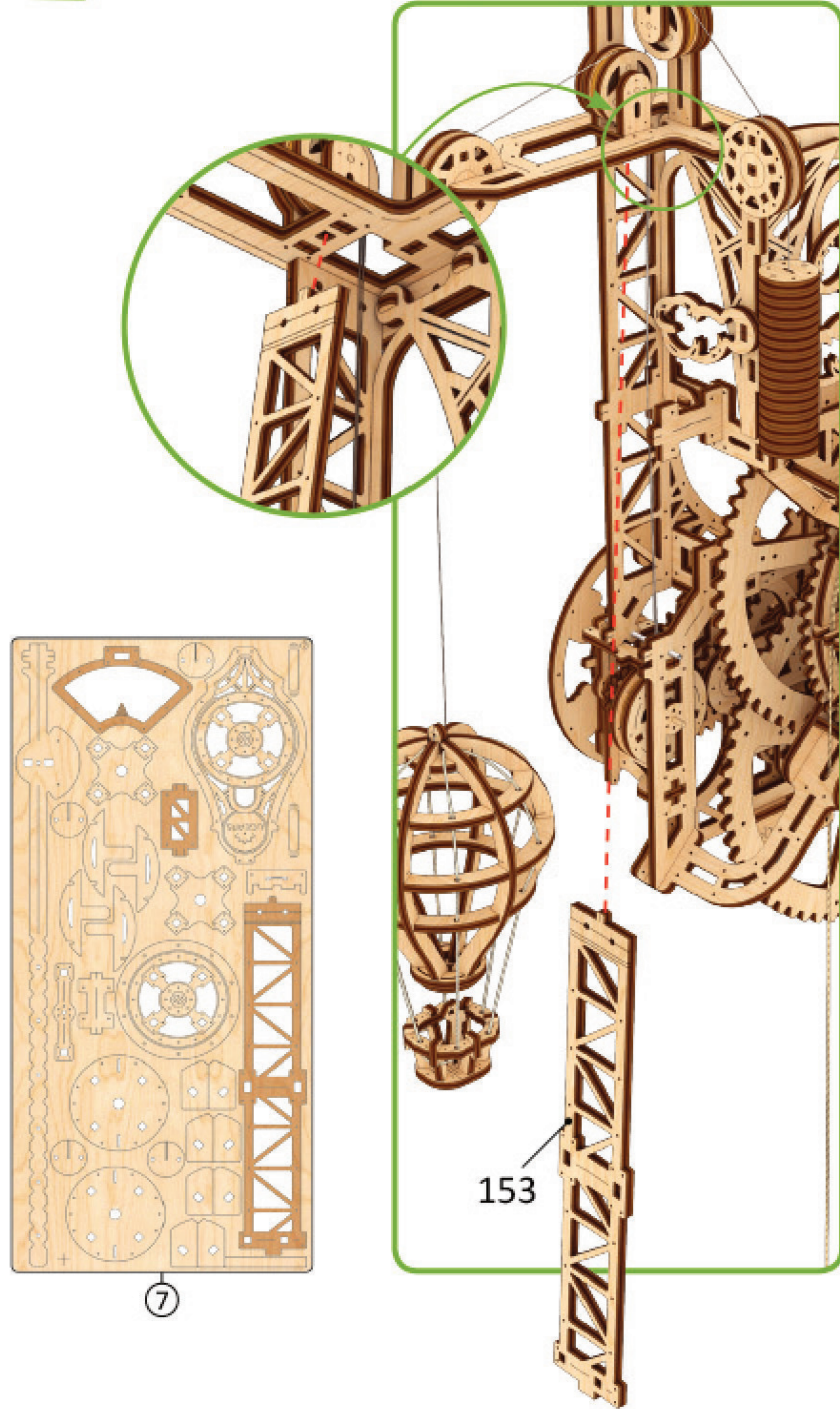

13

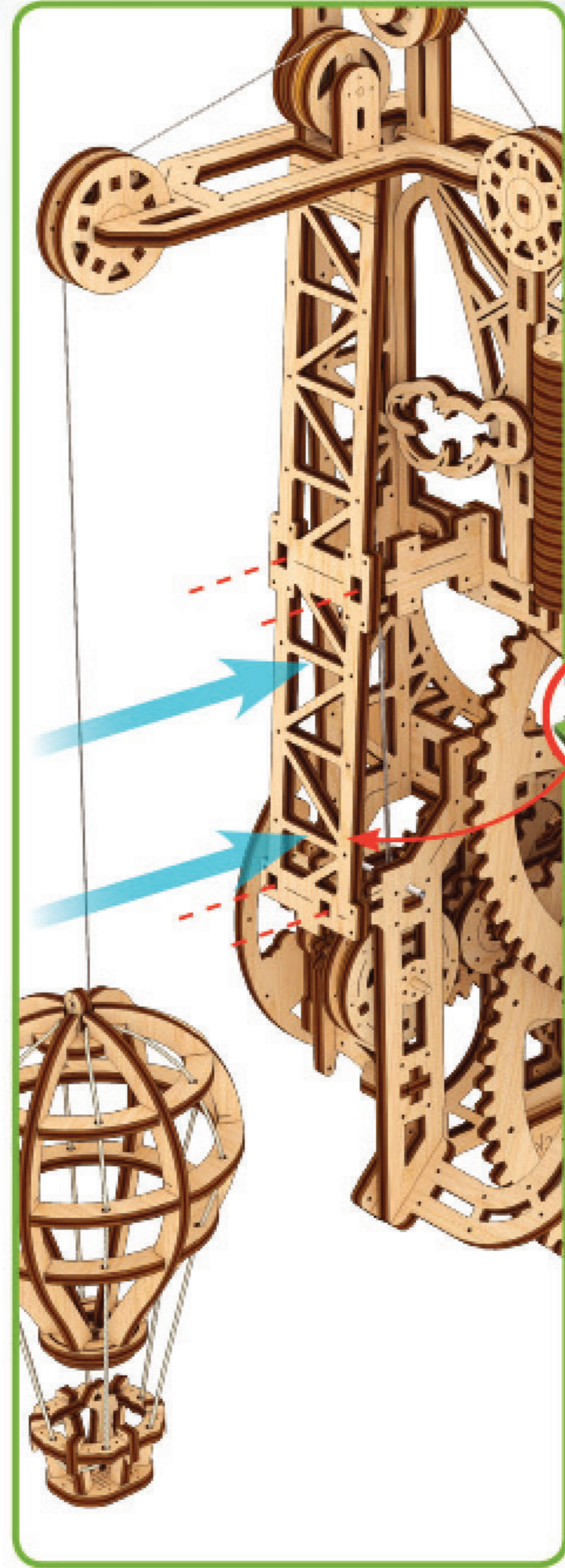

14

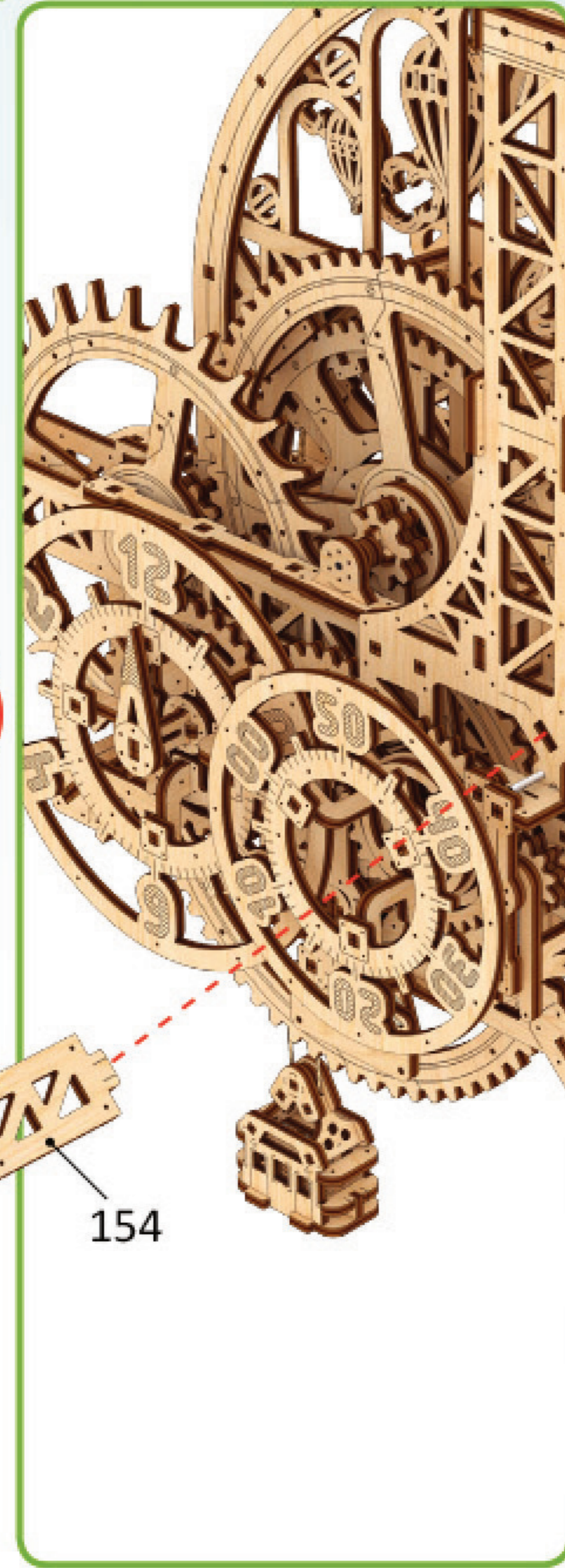

15

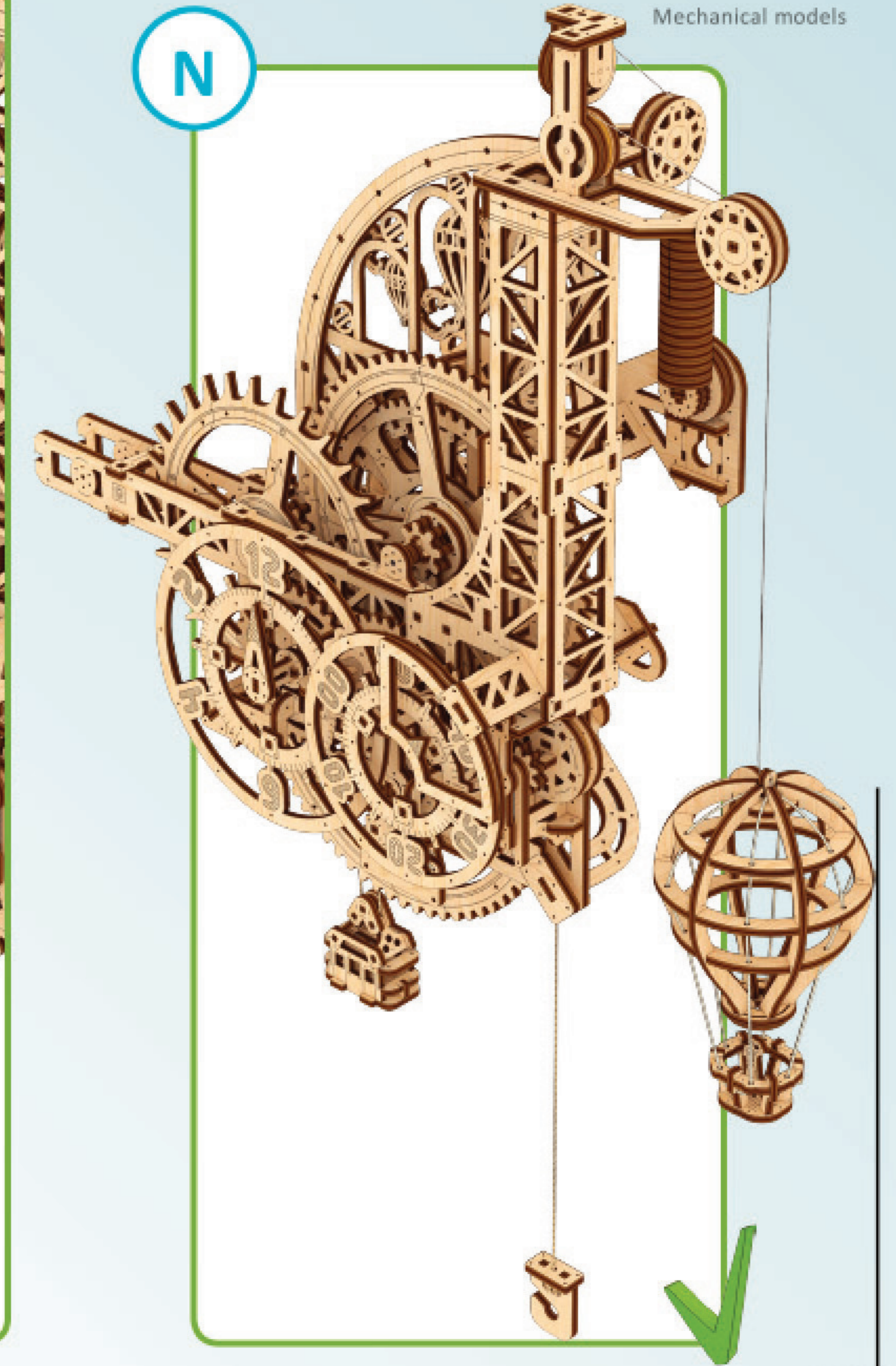
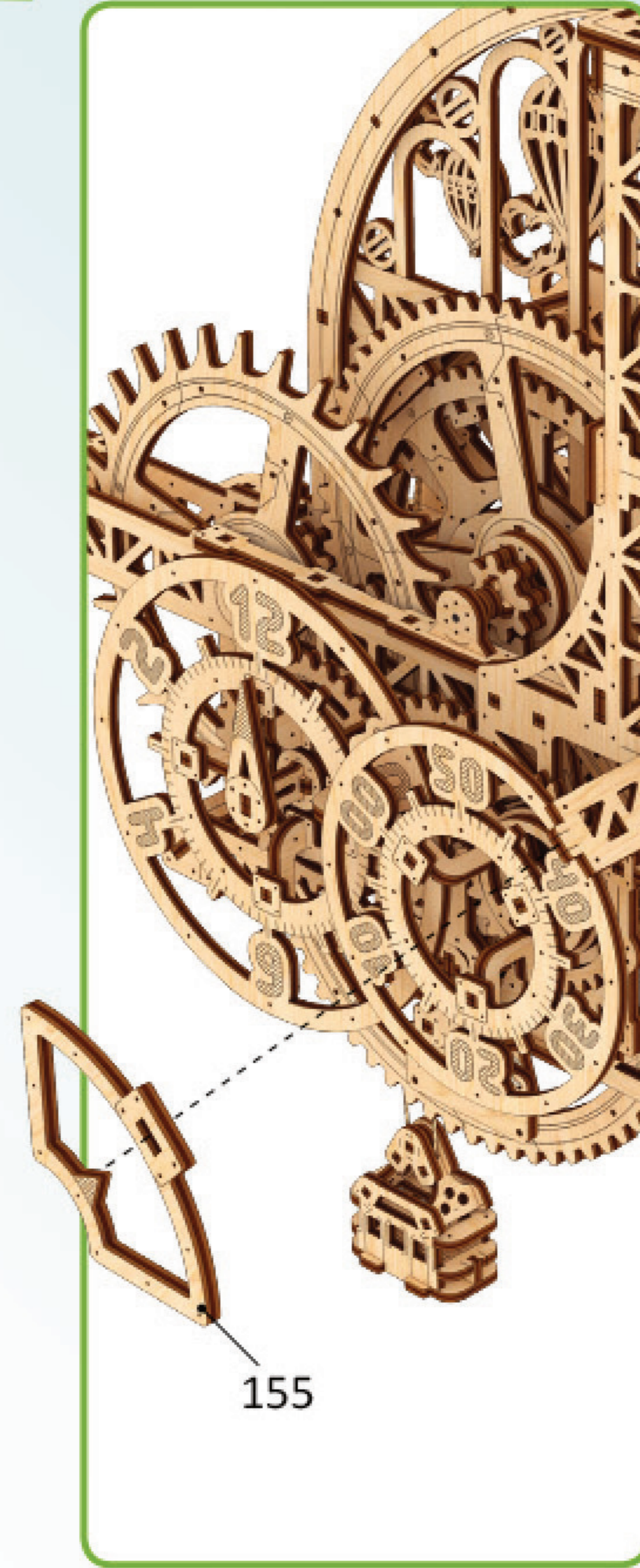

1

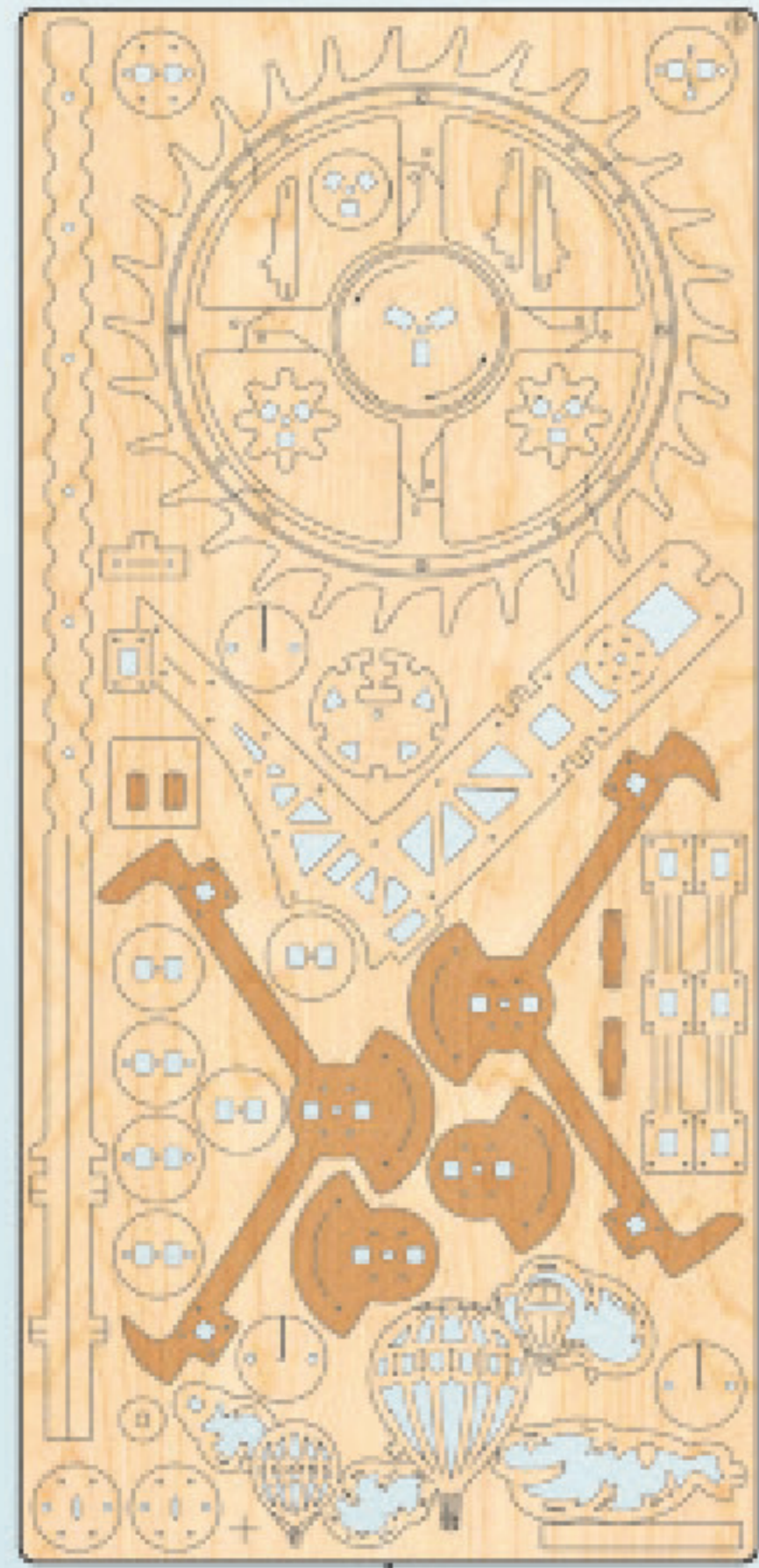

6

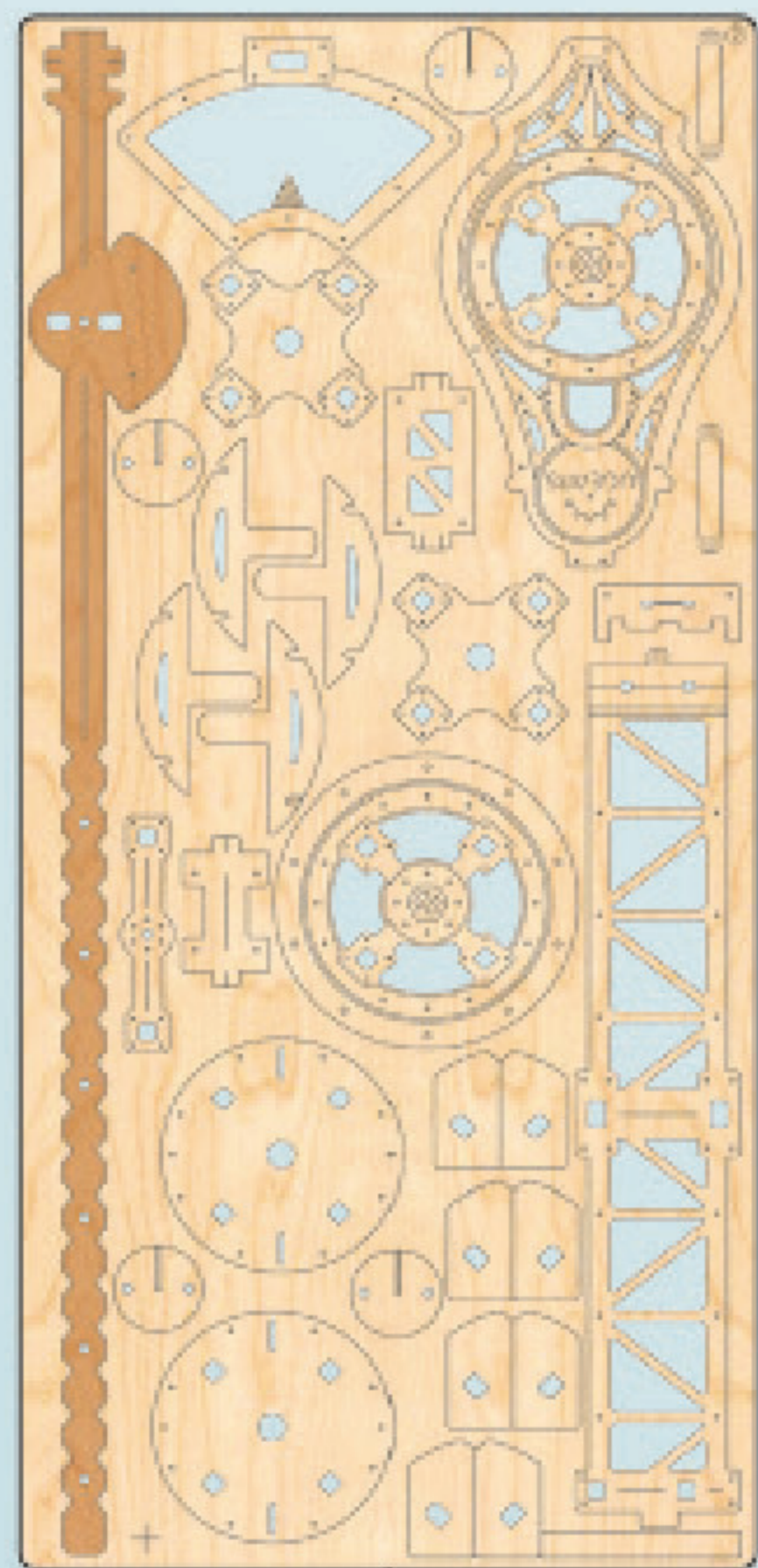

7

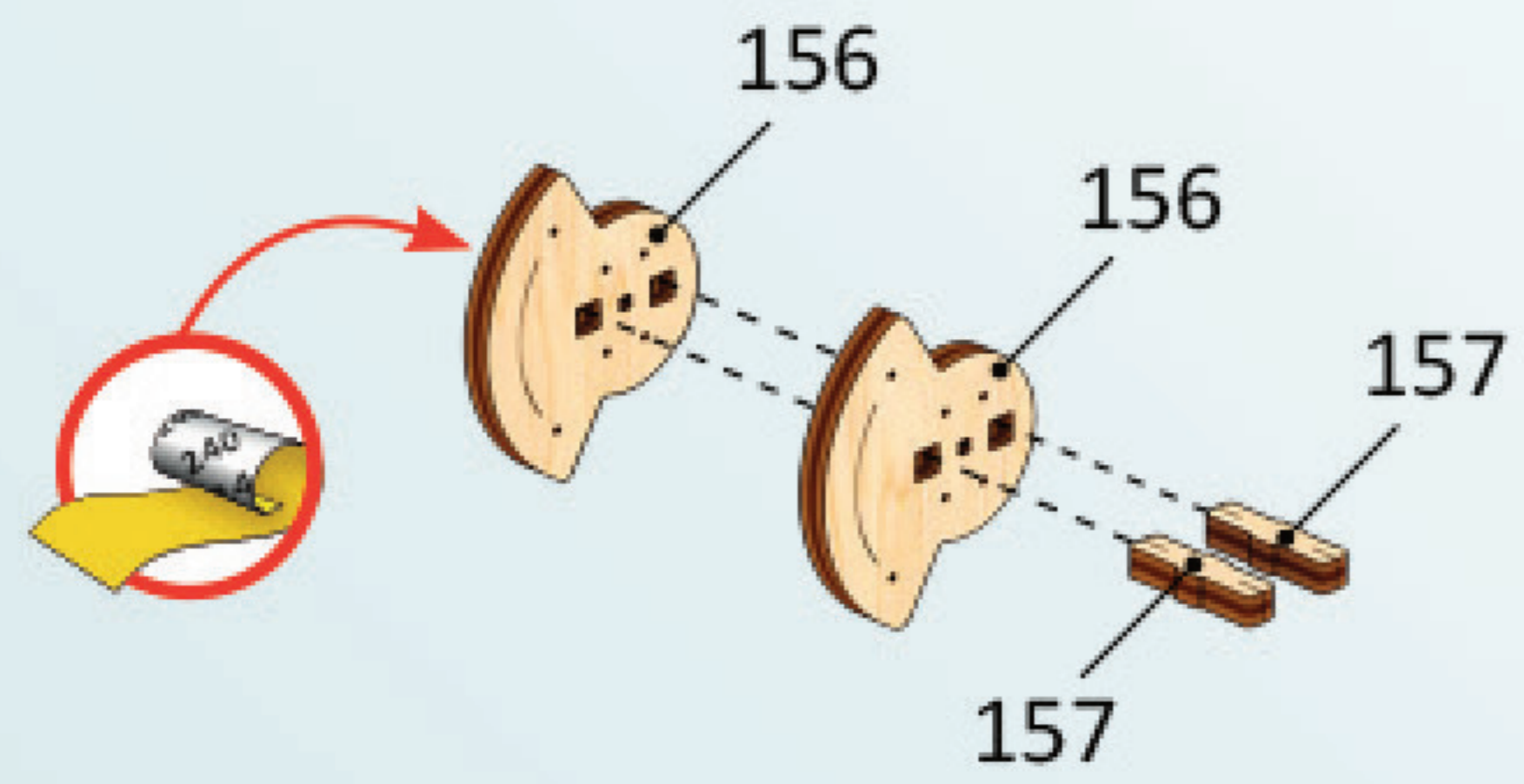

2

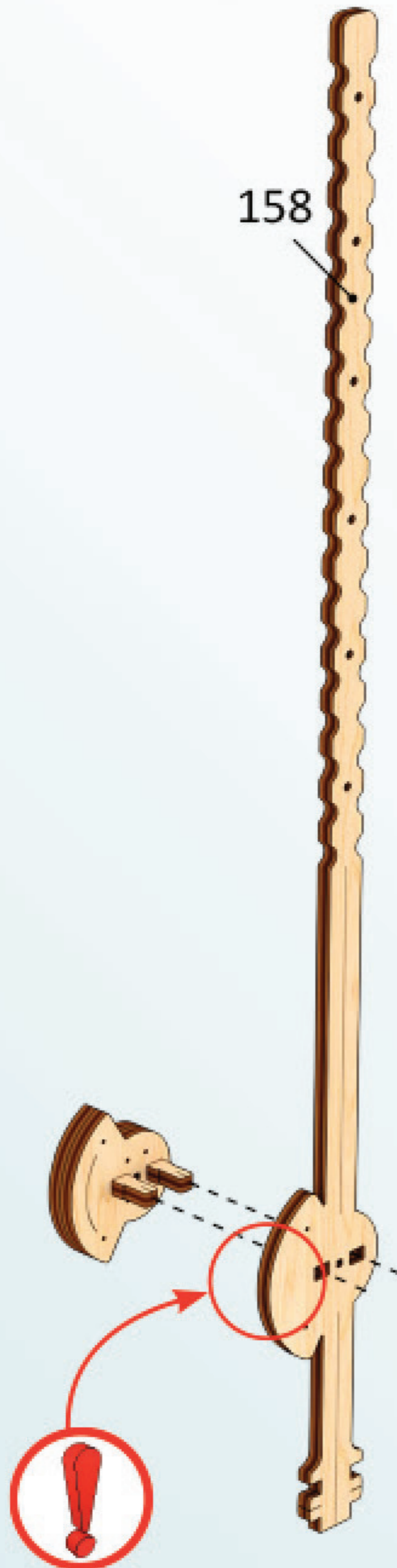

3

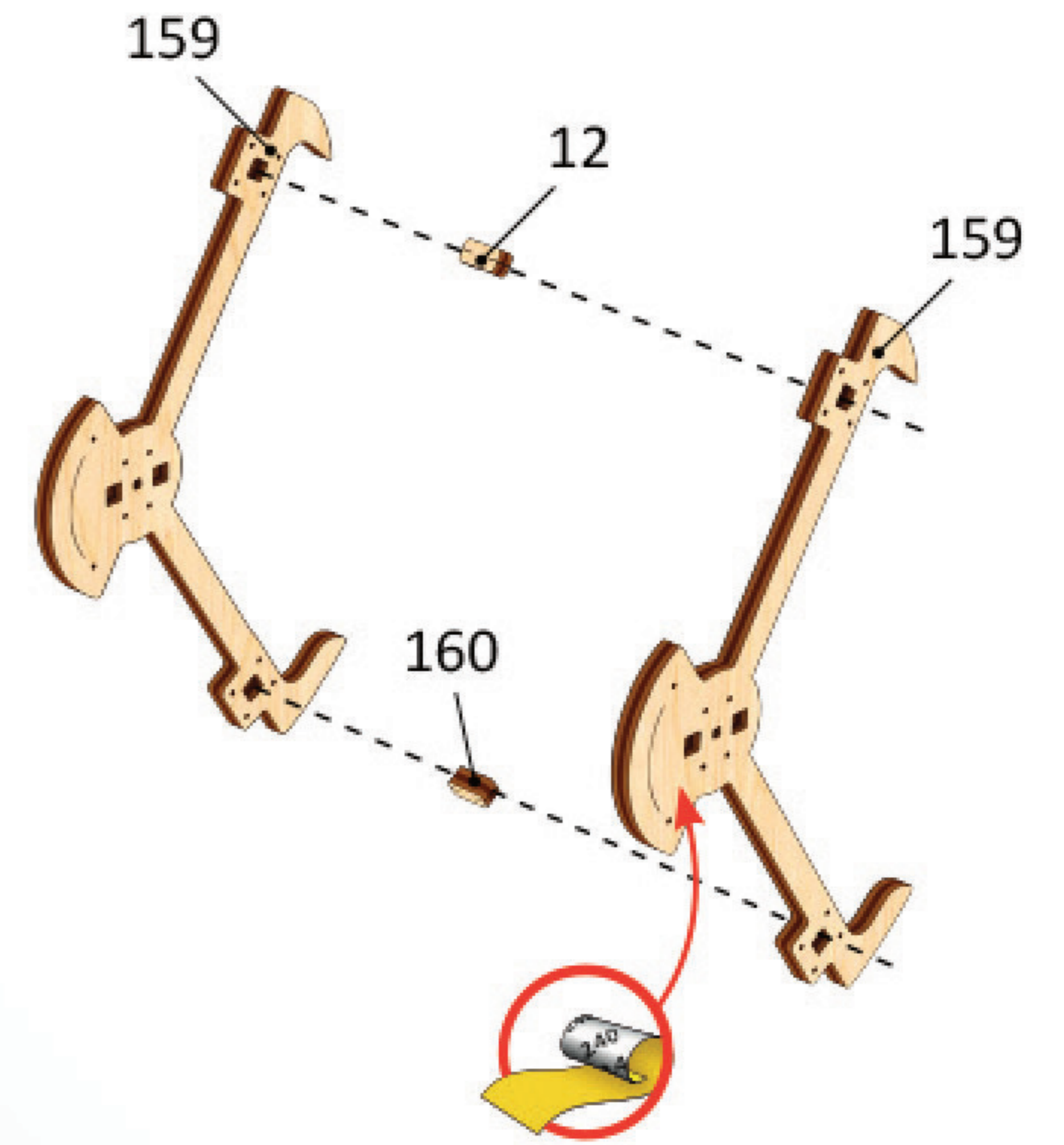
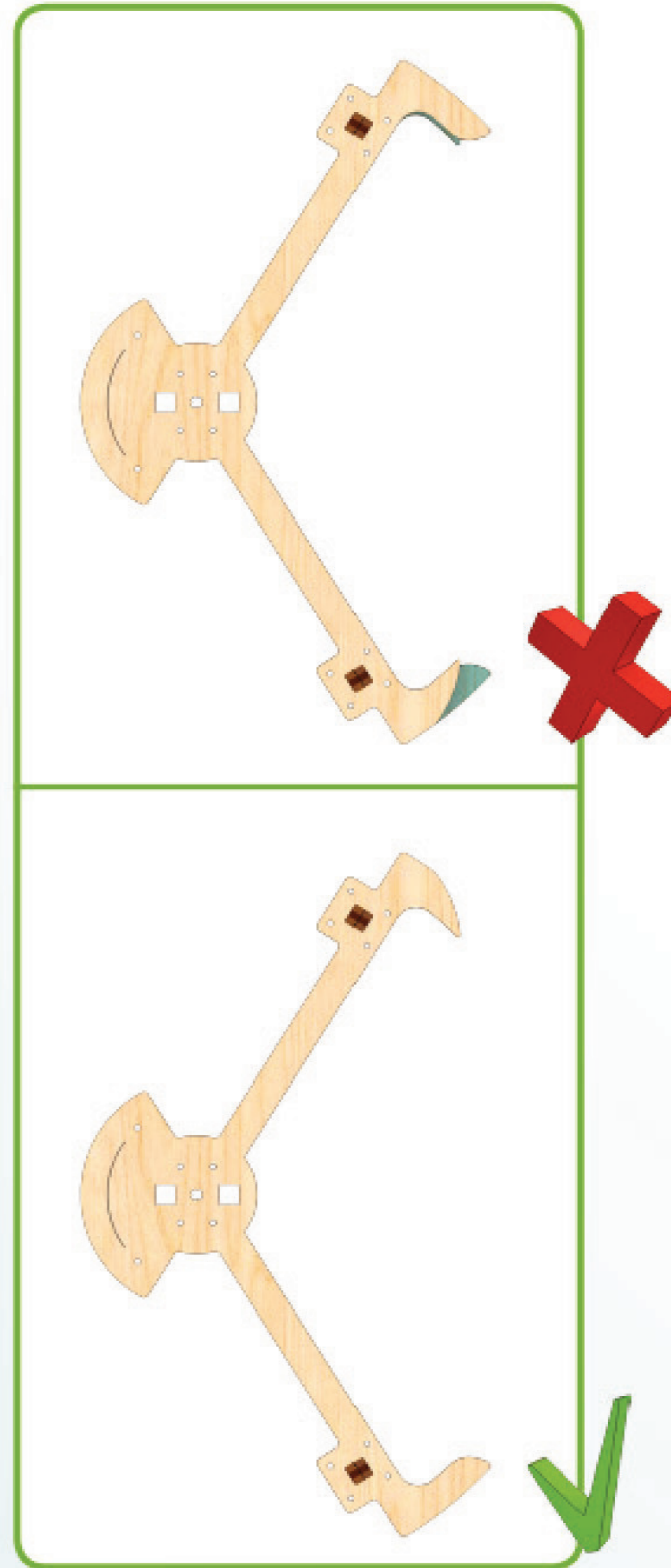



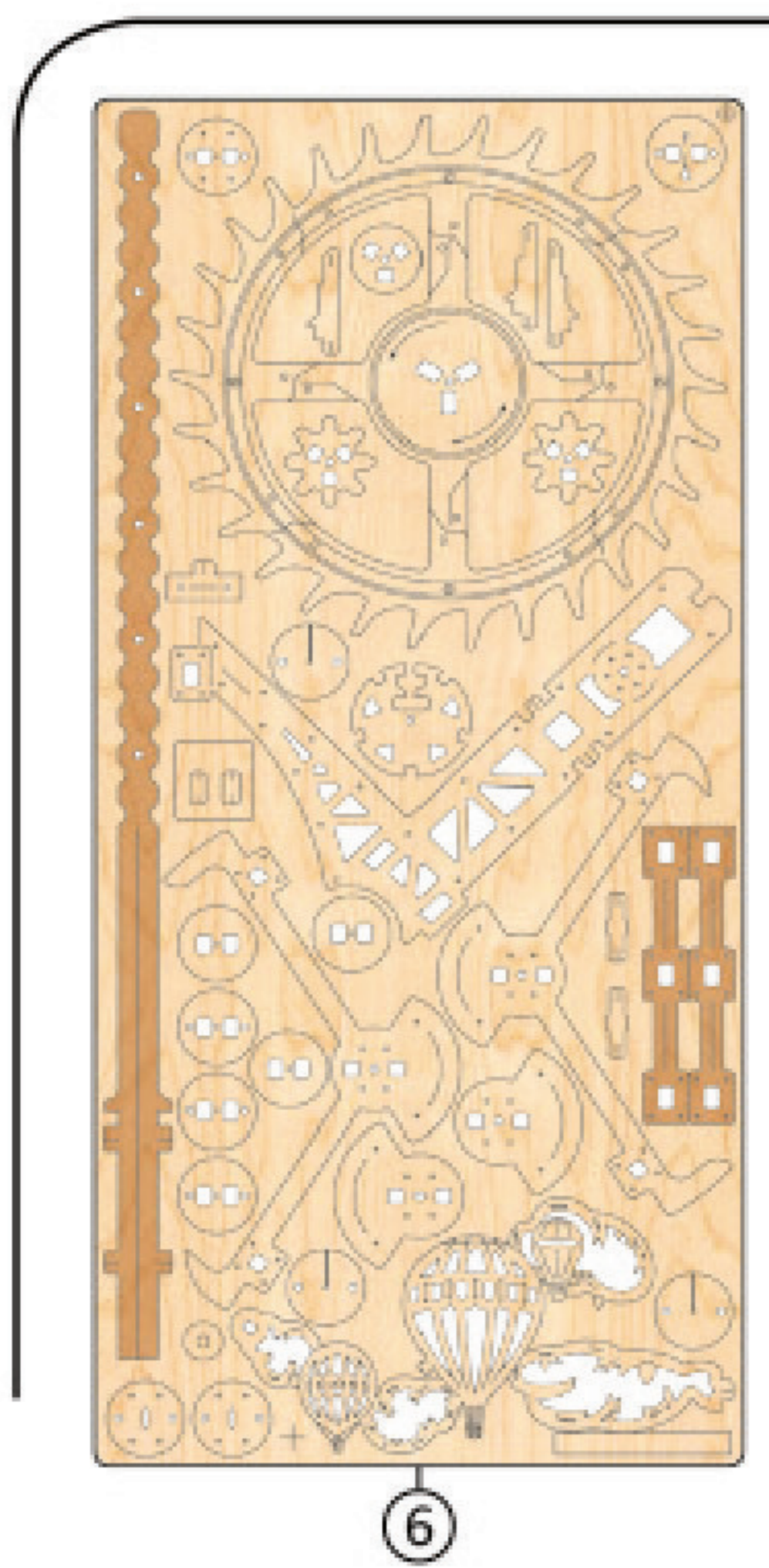

4

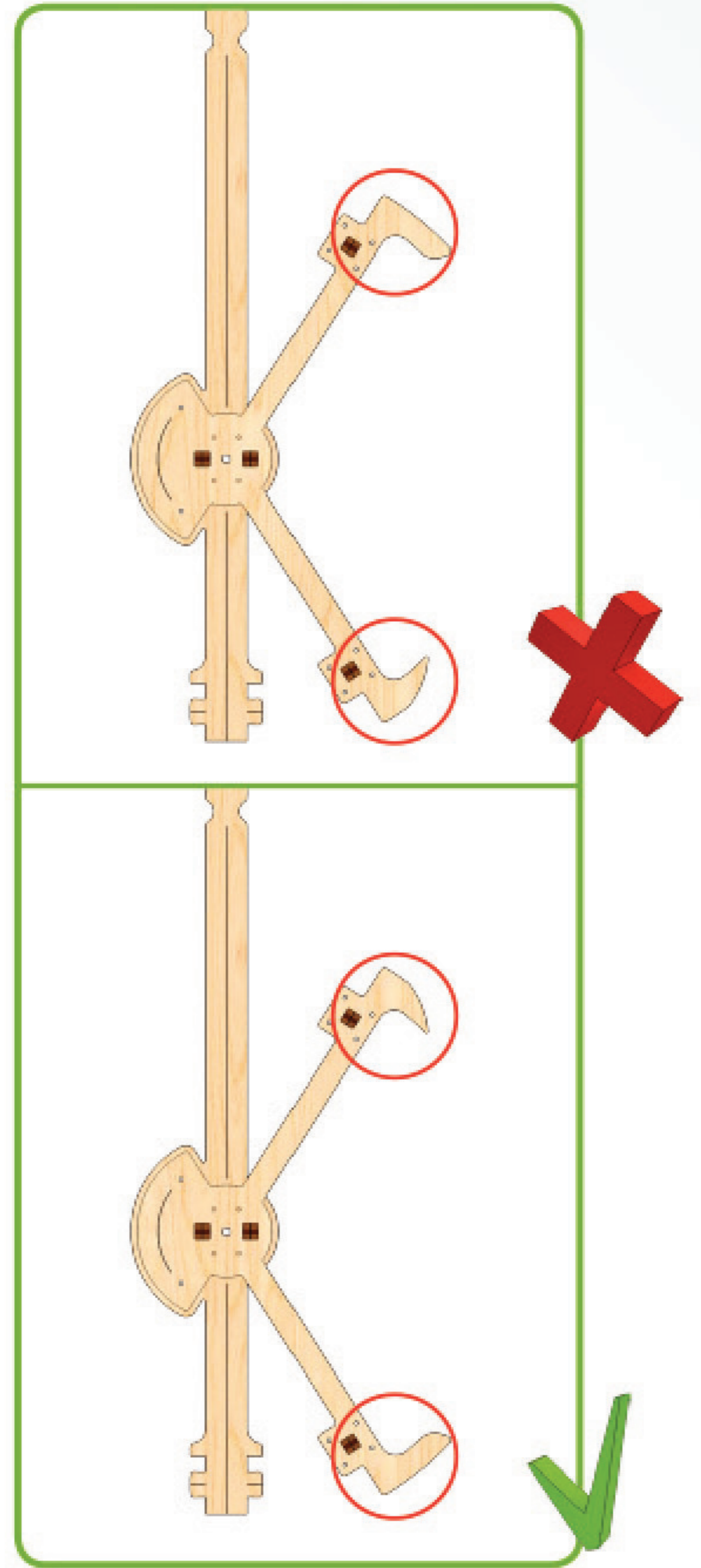

5

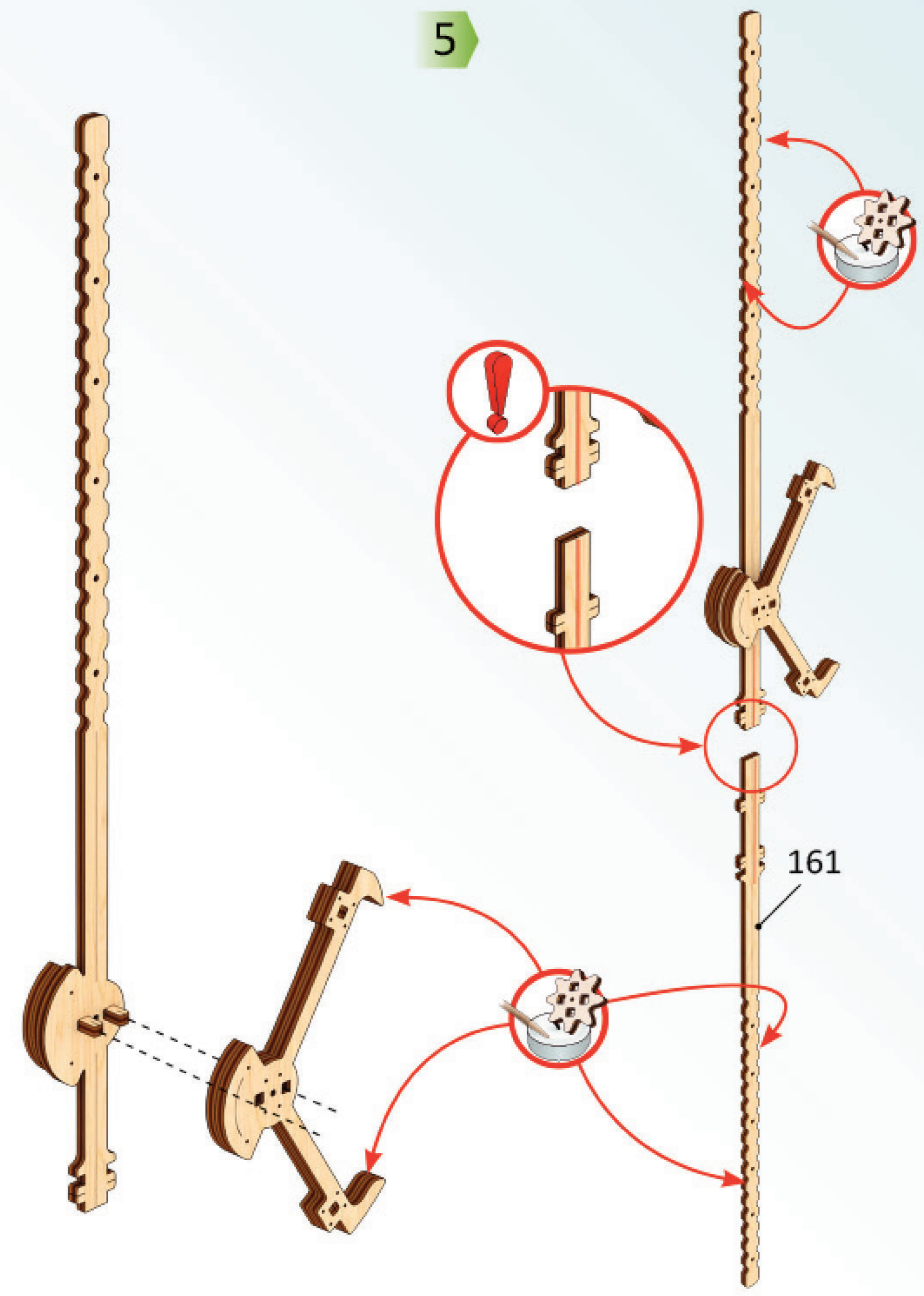

6

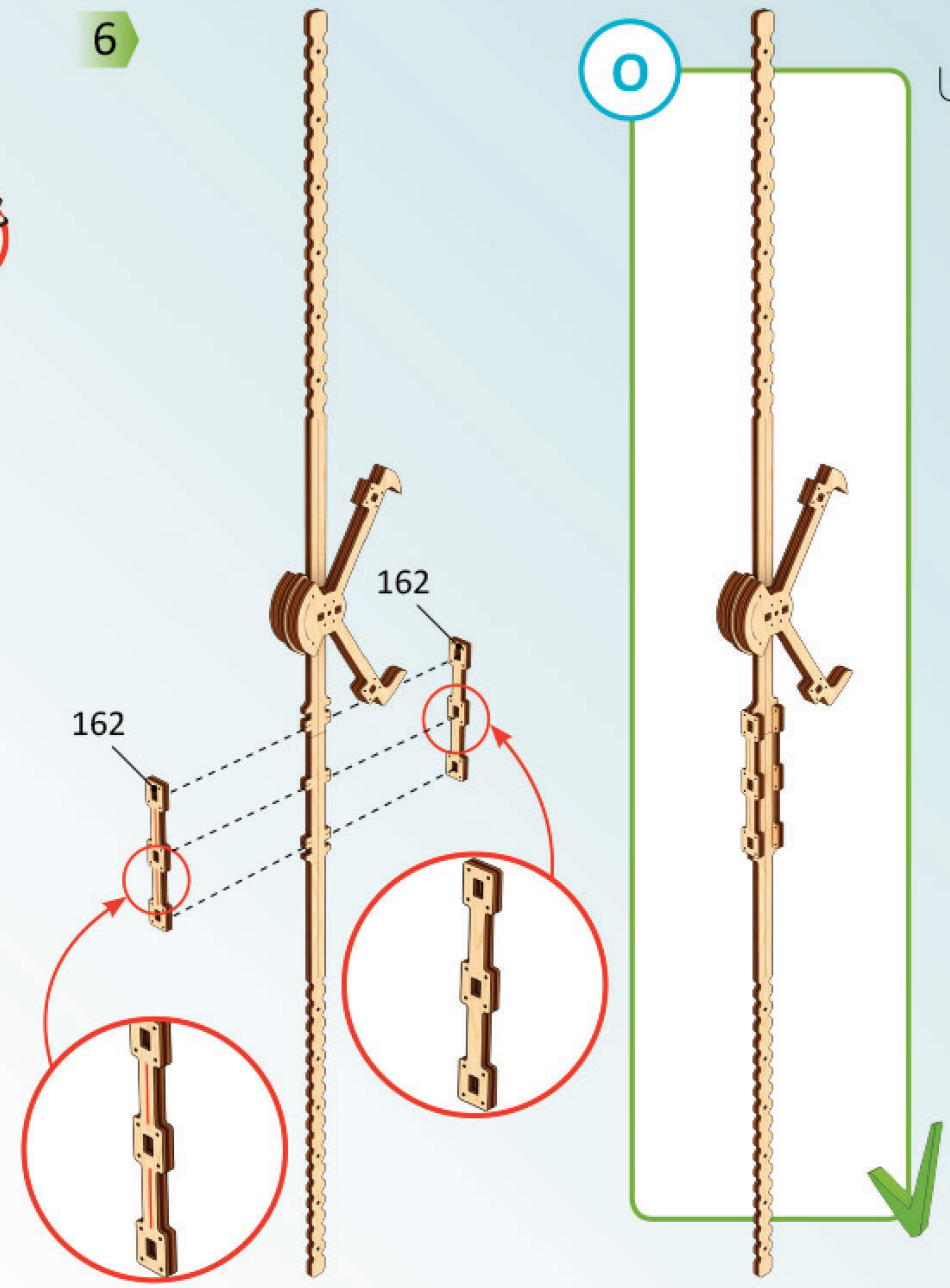

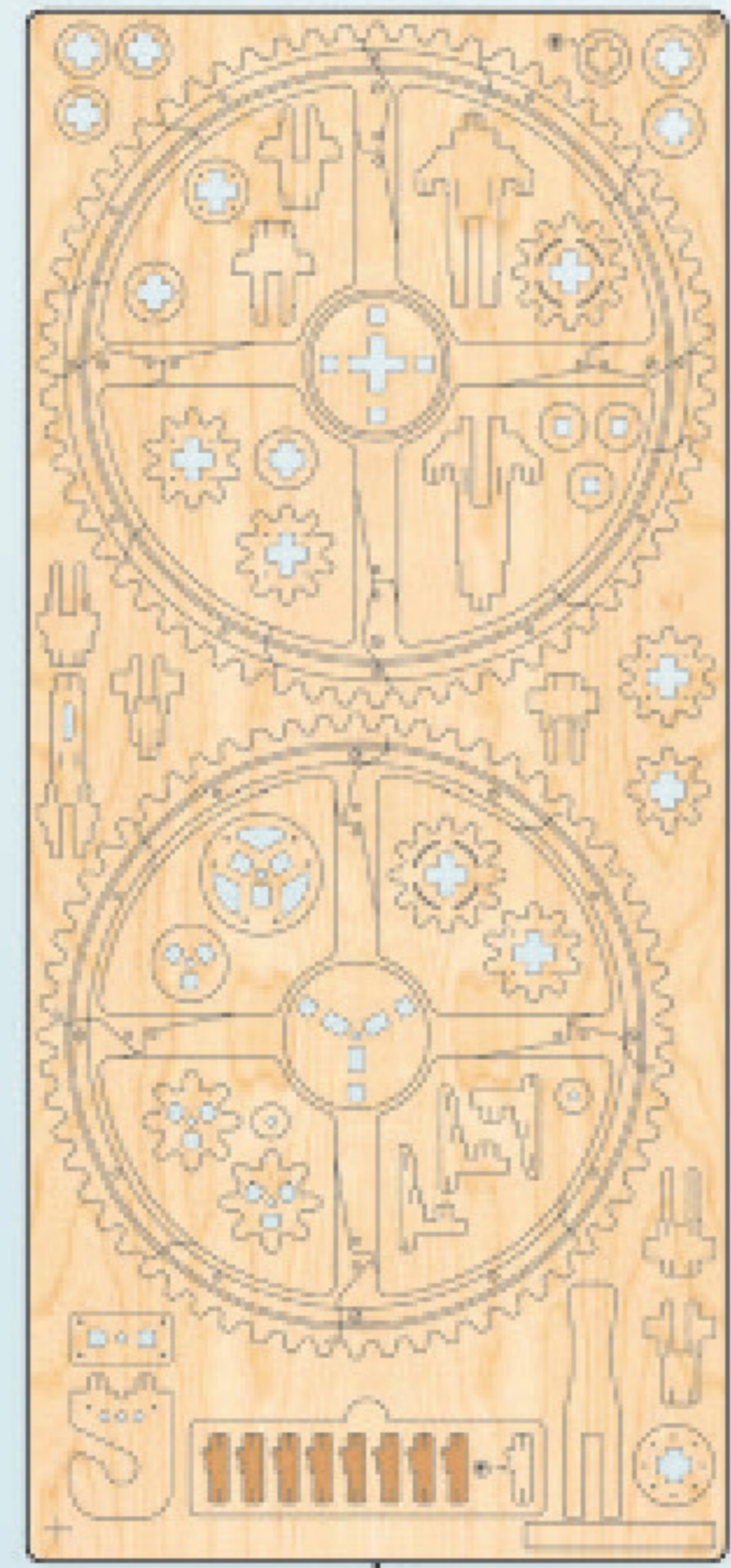

5

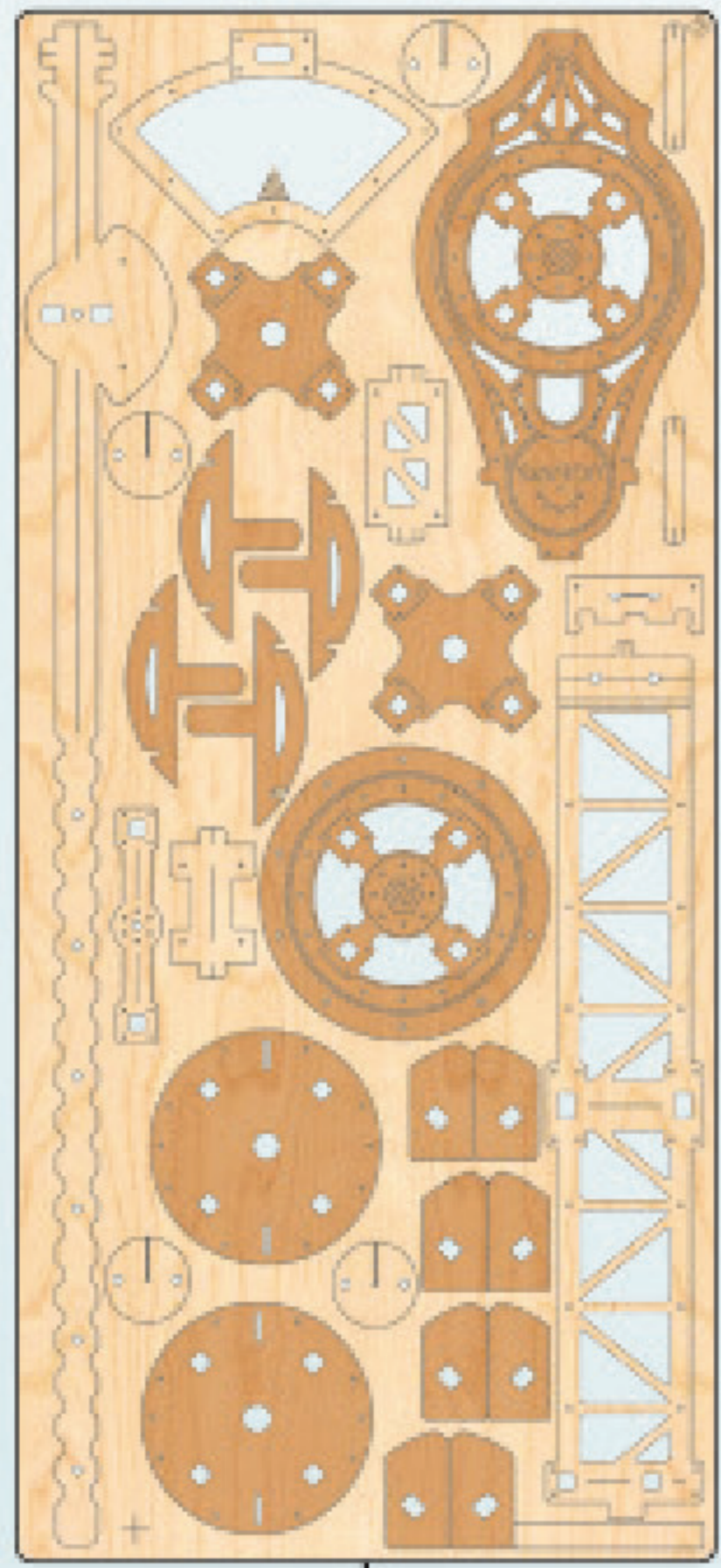

7

1

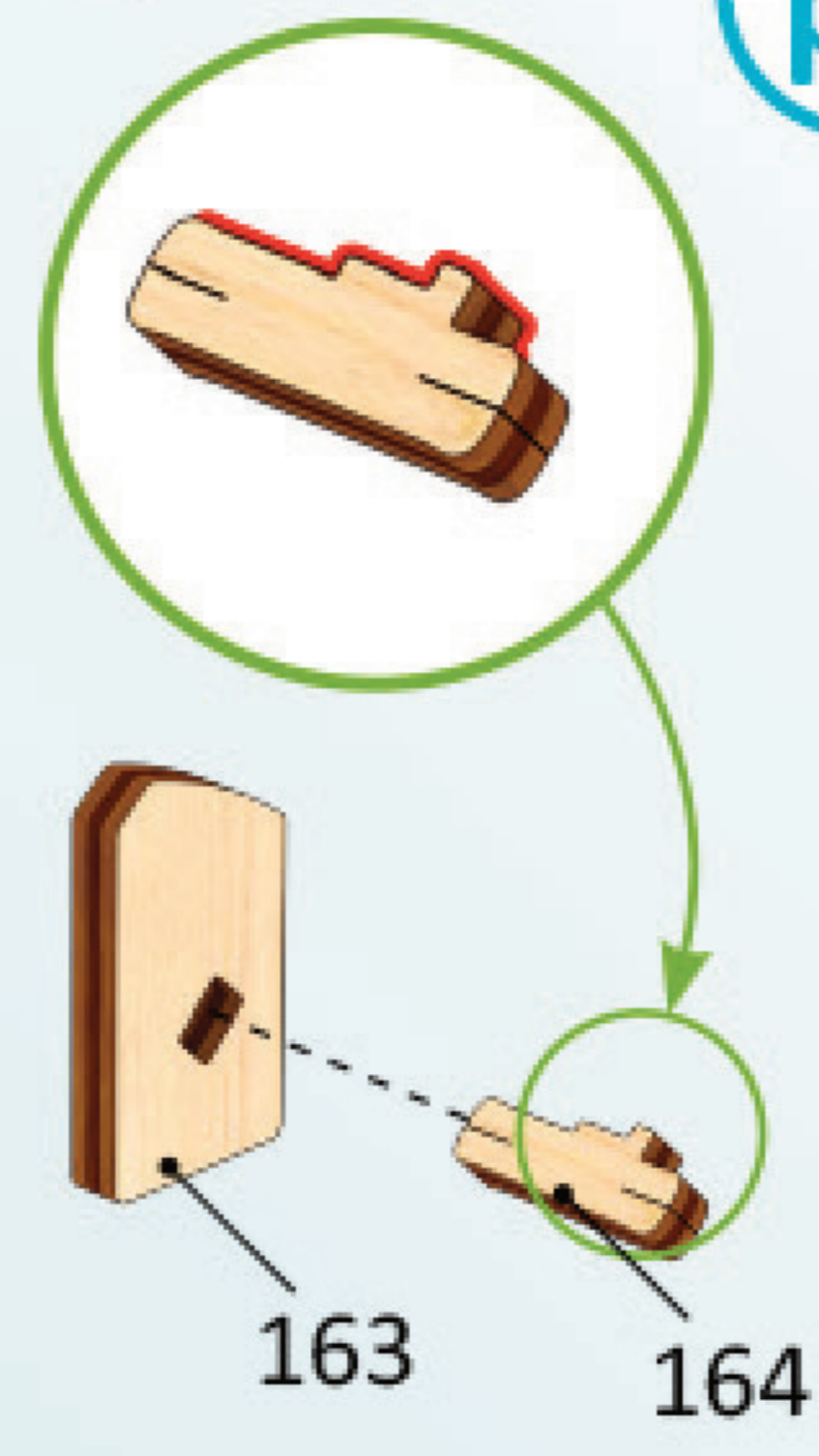

p1

x4



2

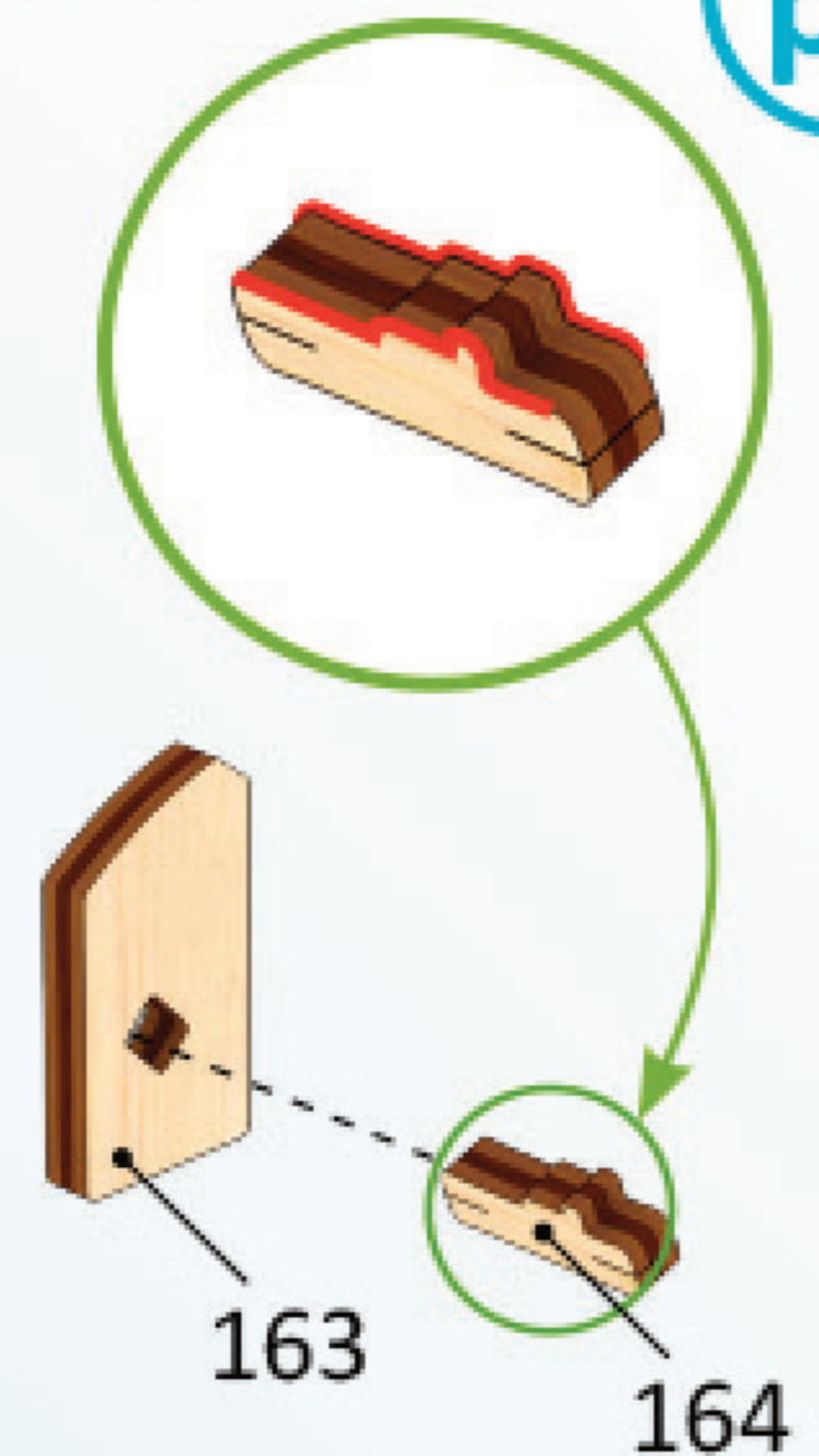

p2

x4



3

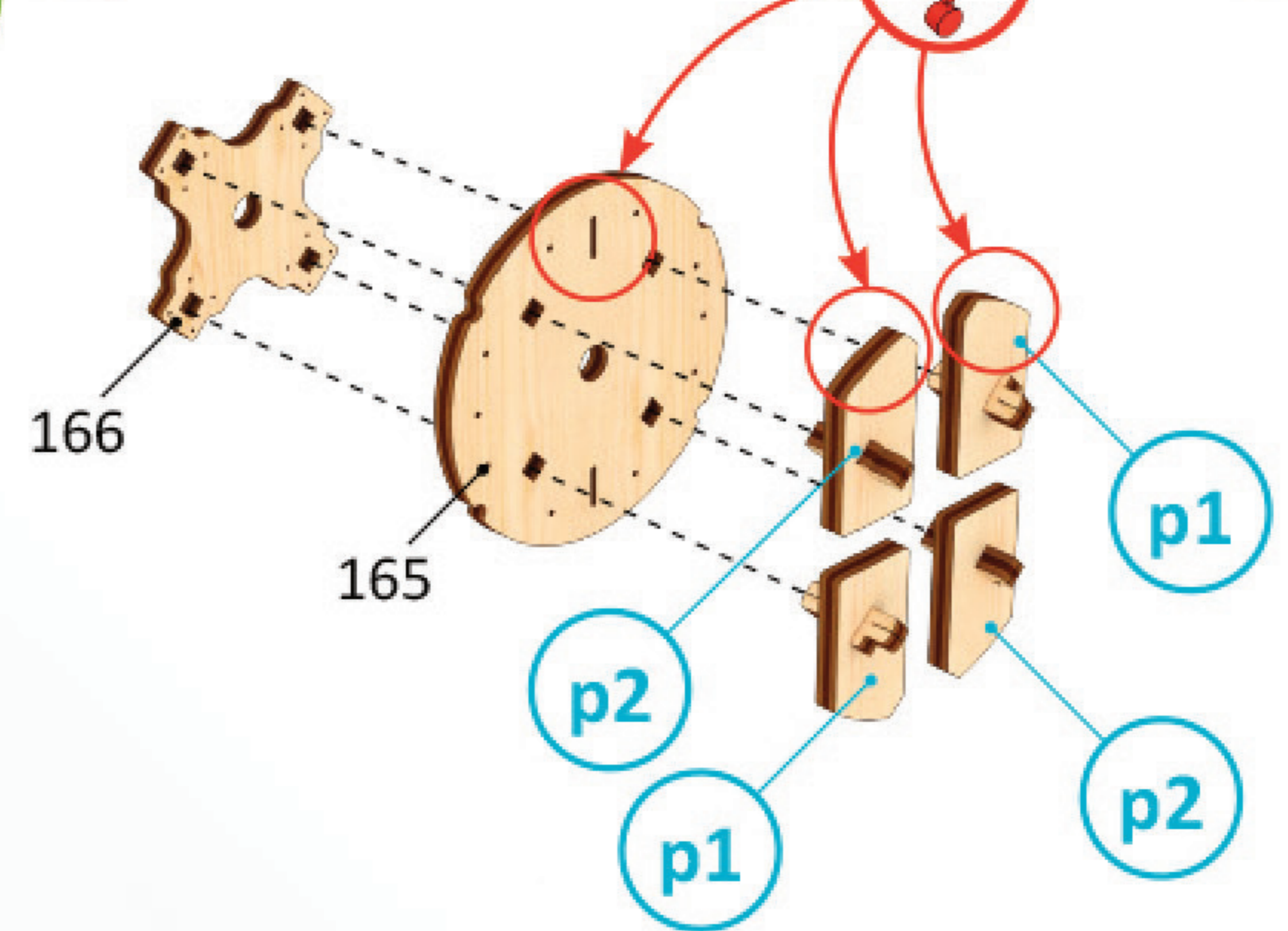

4

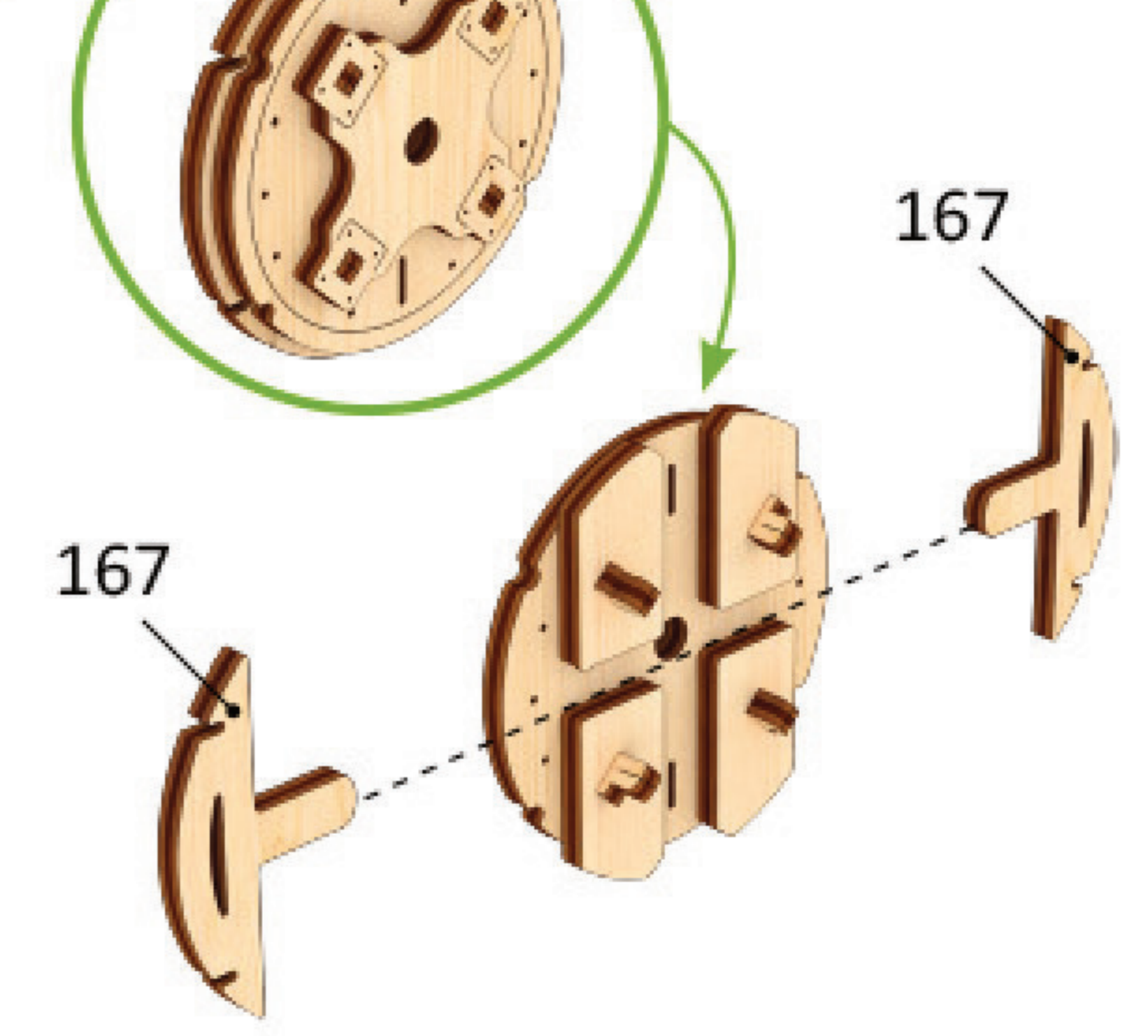

5

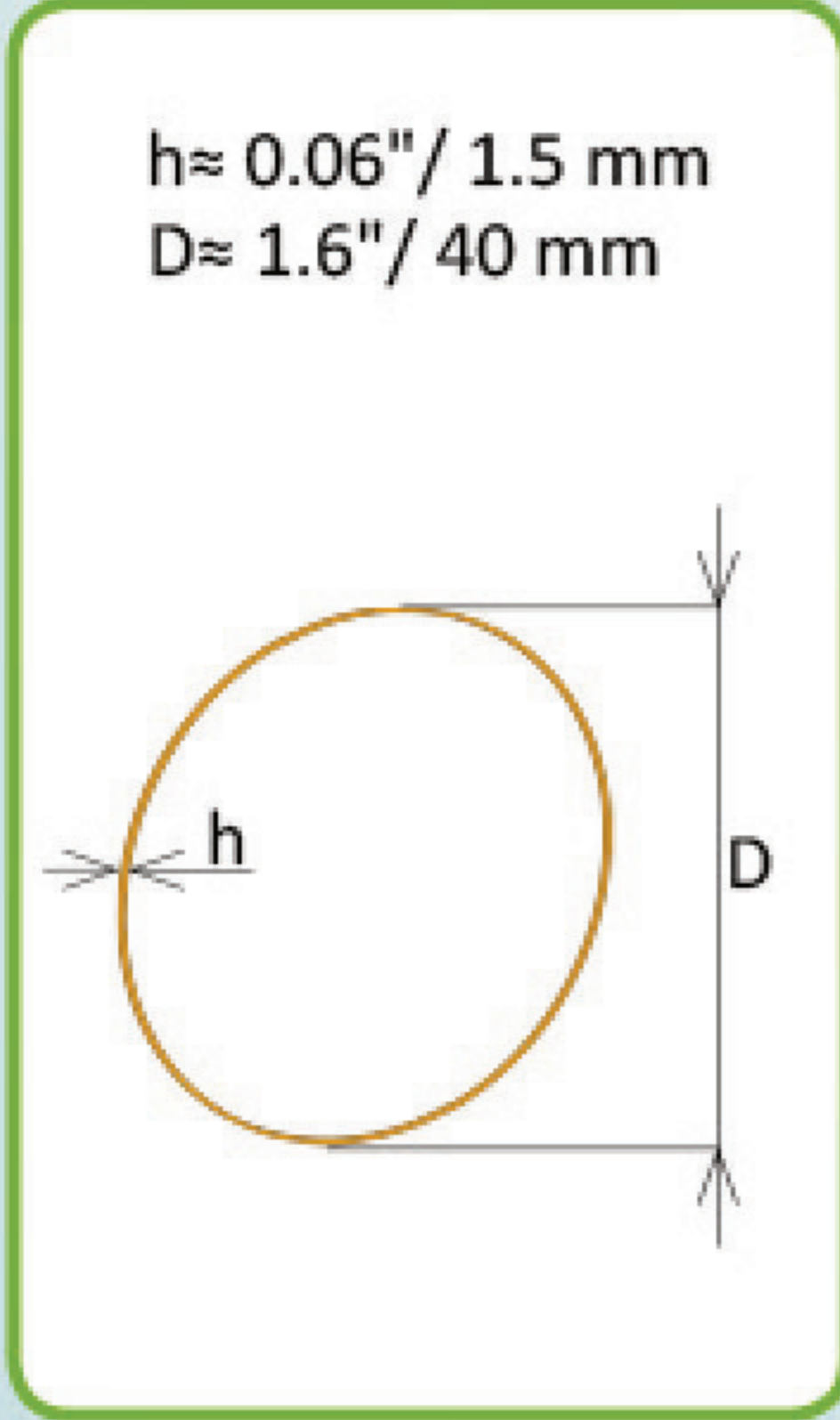

6

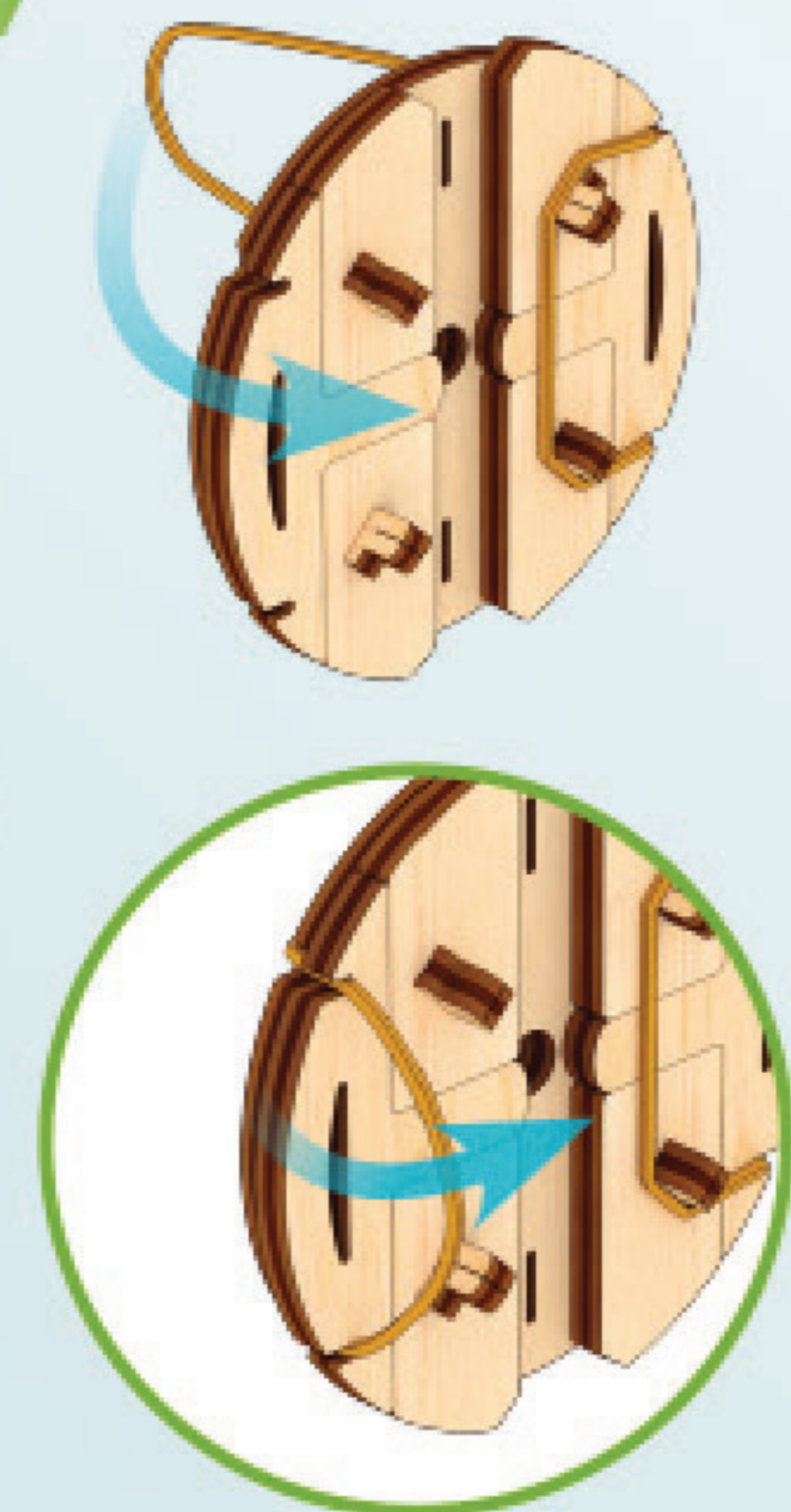

P

x2

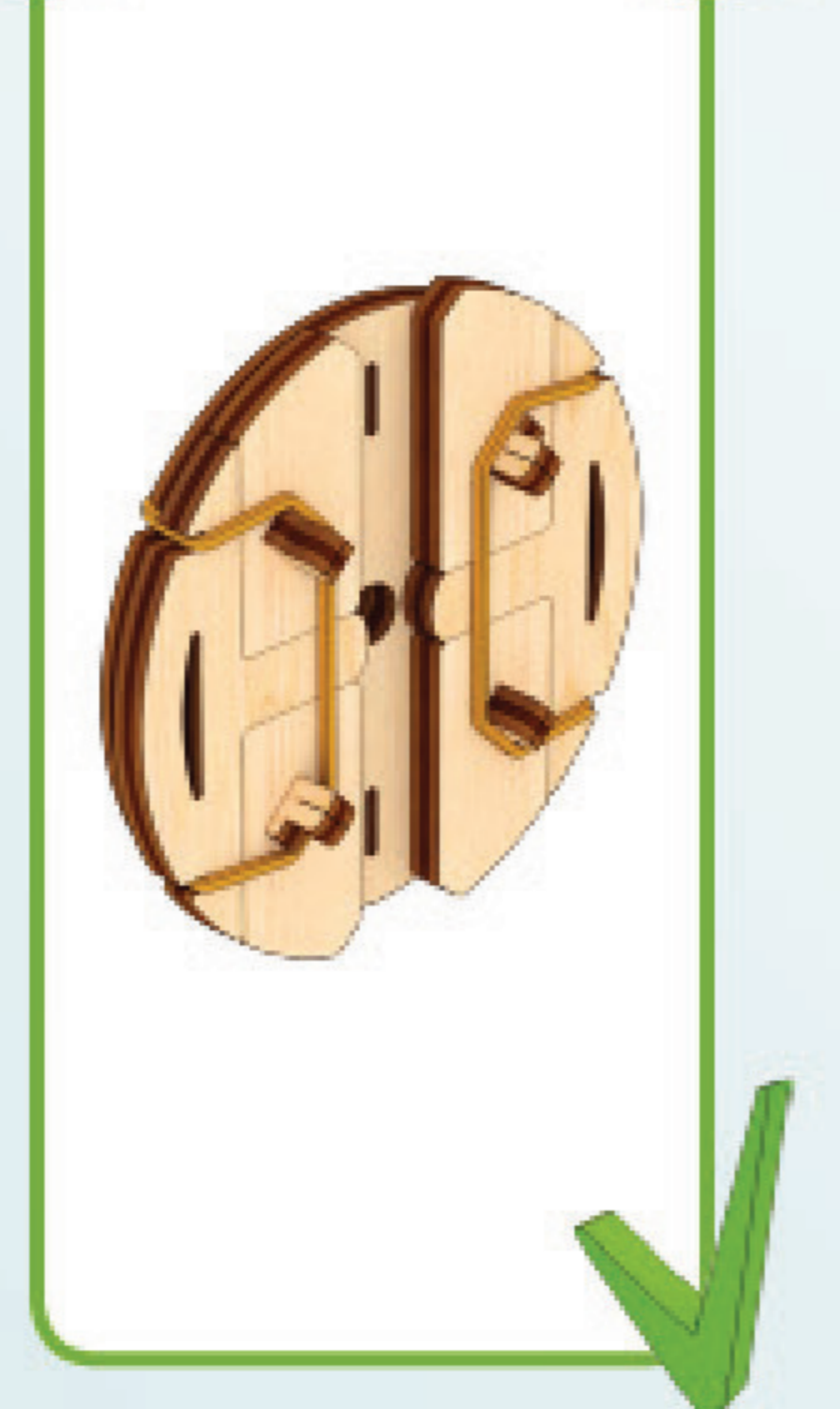

1

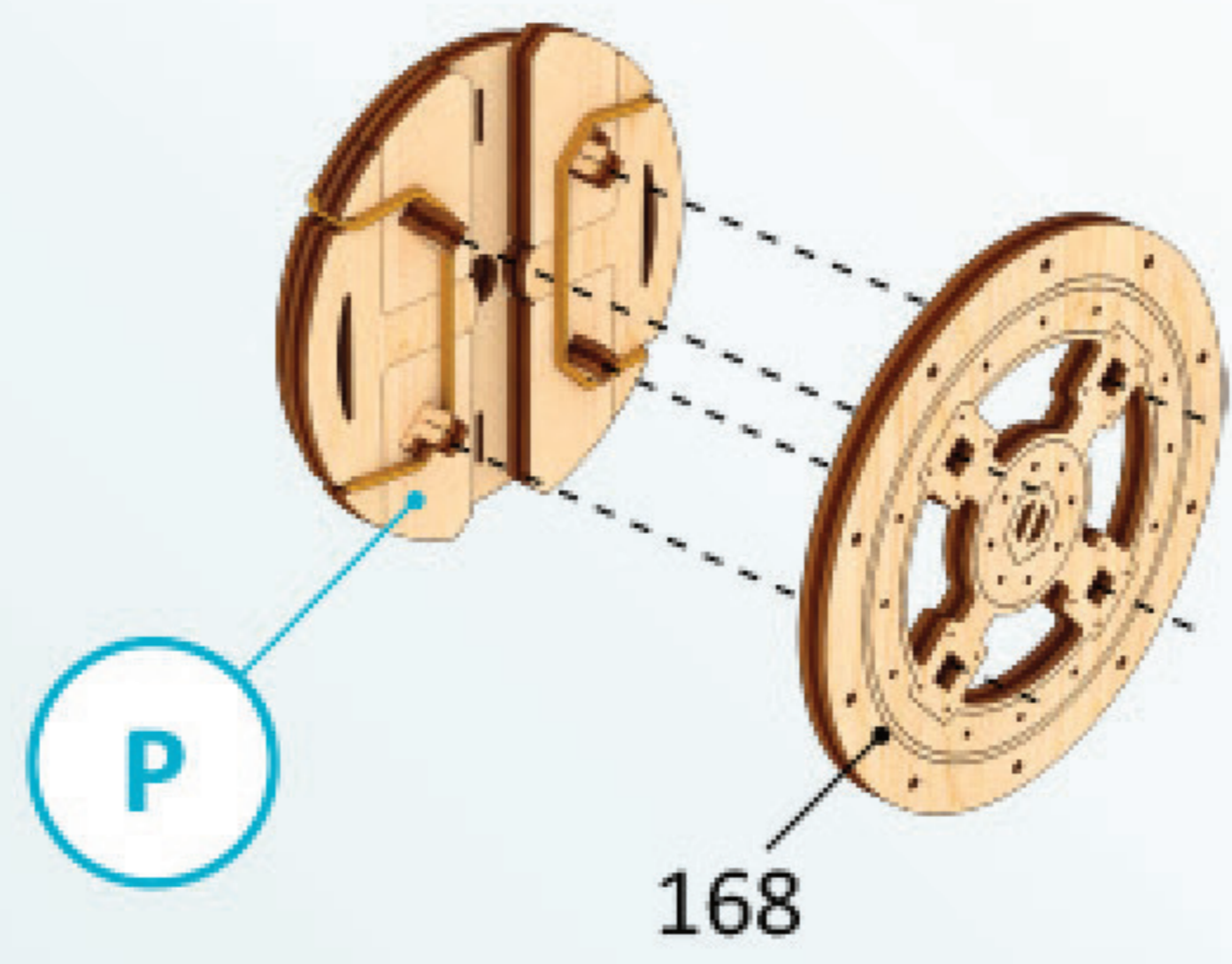

q1



1

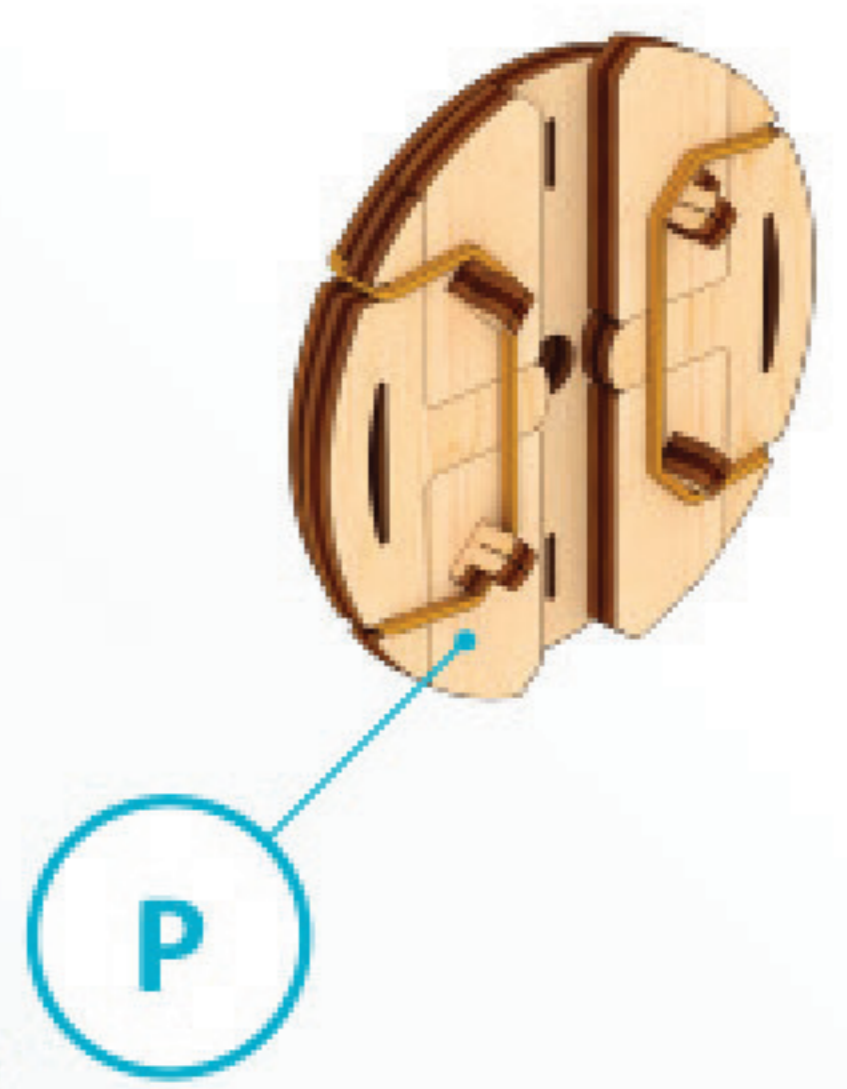

q2



1

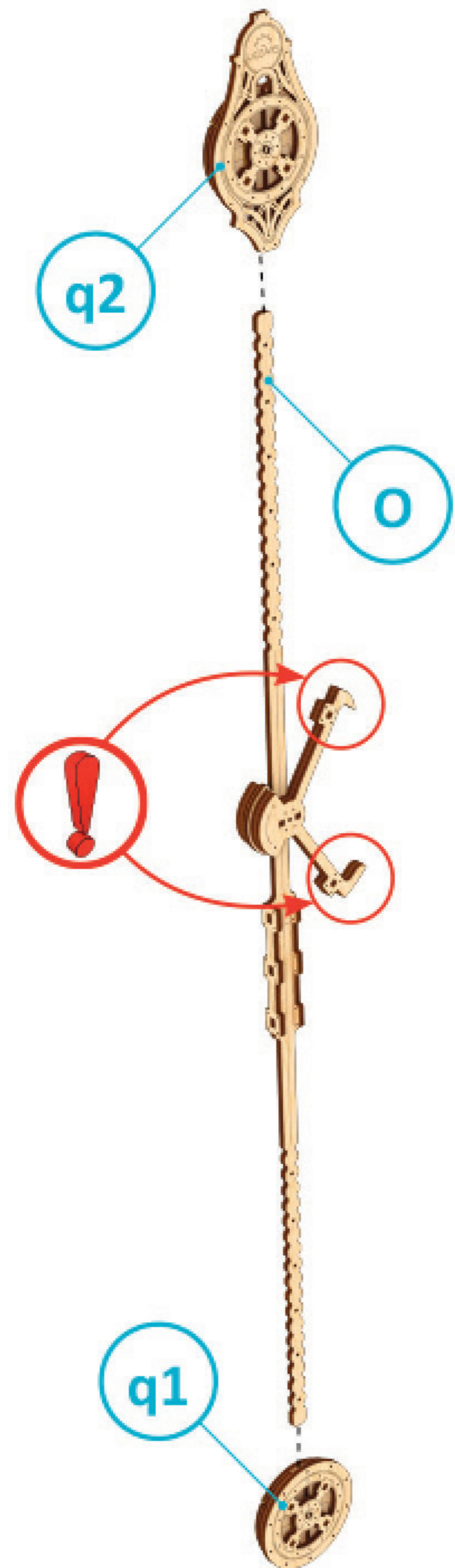

2

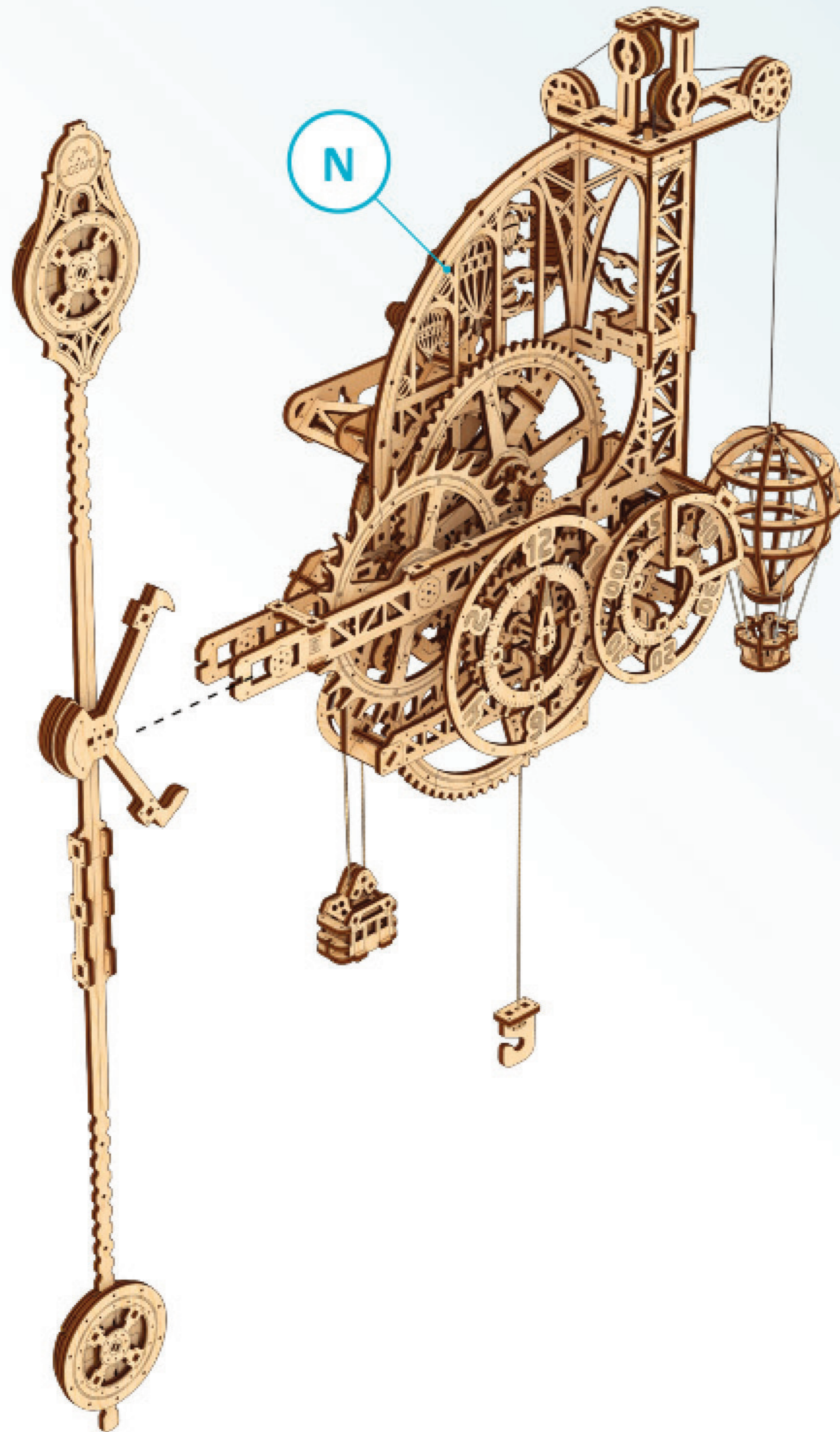

3

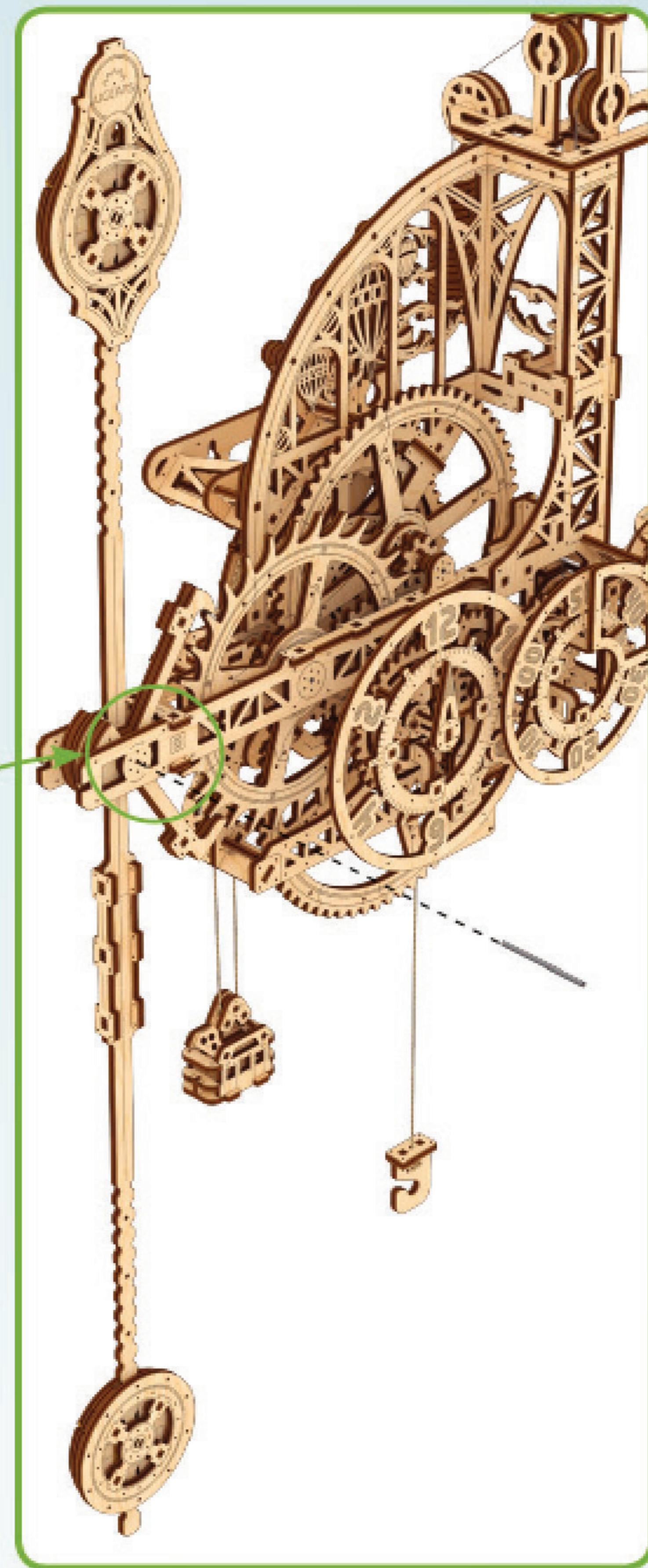
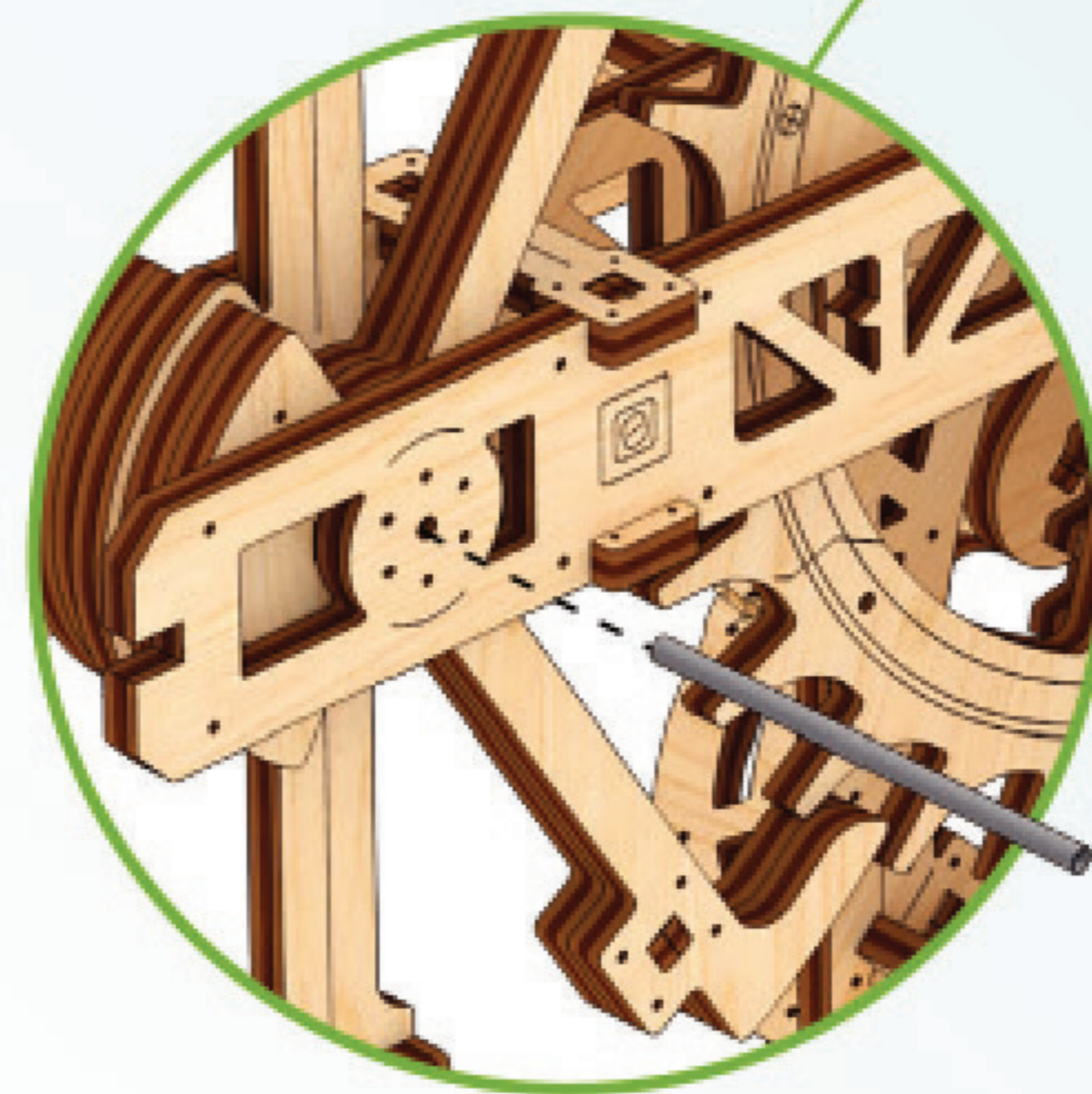

4

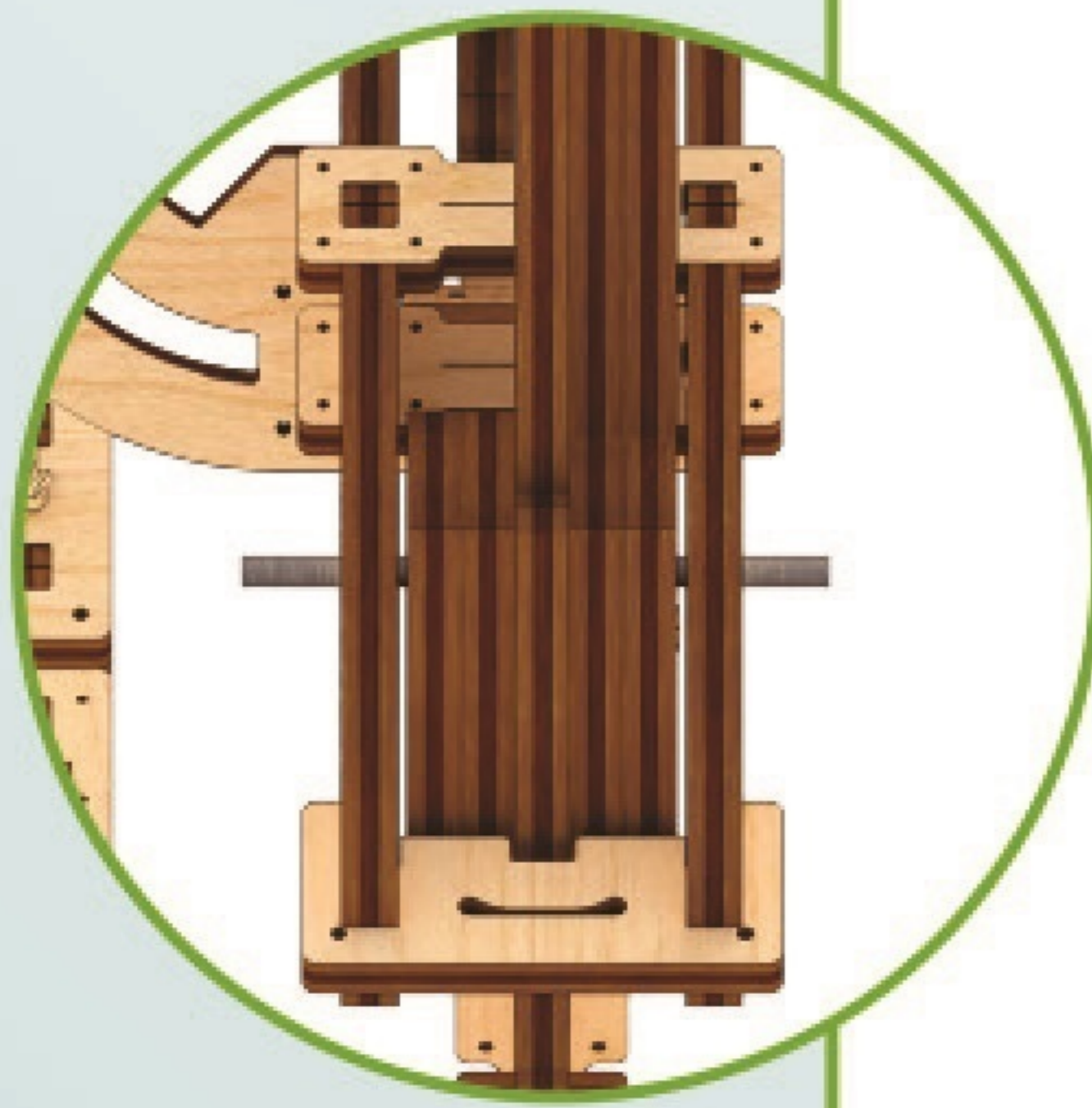
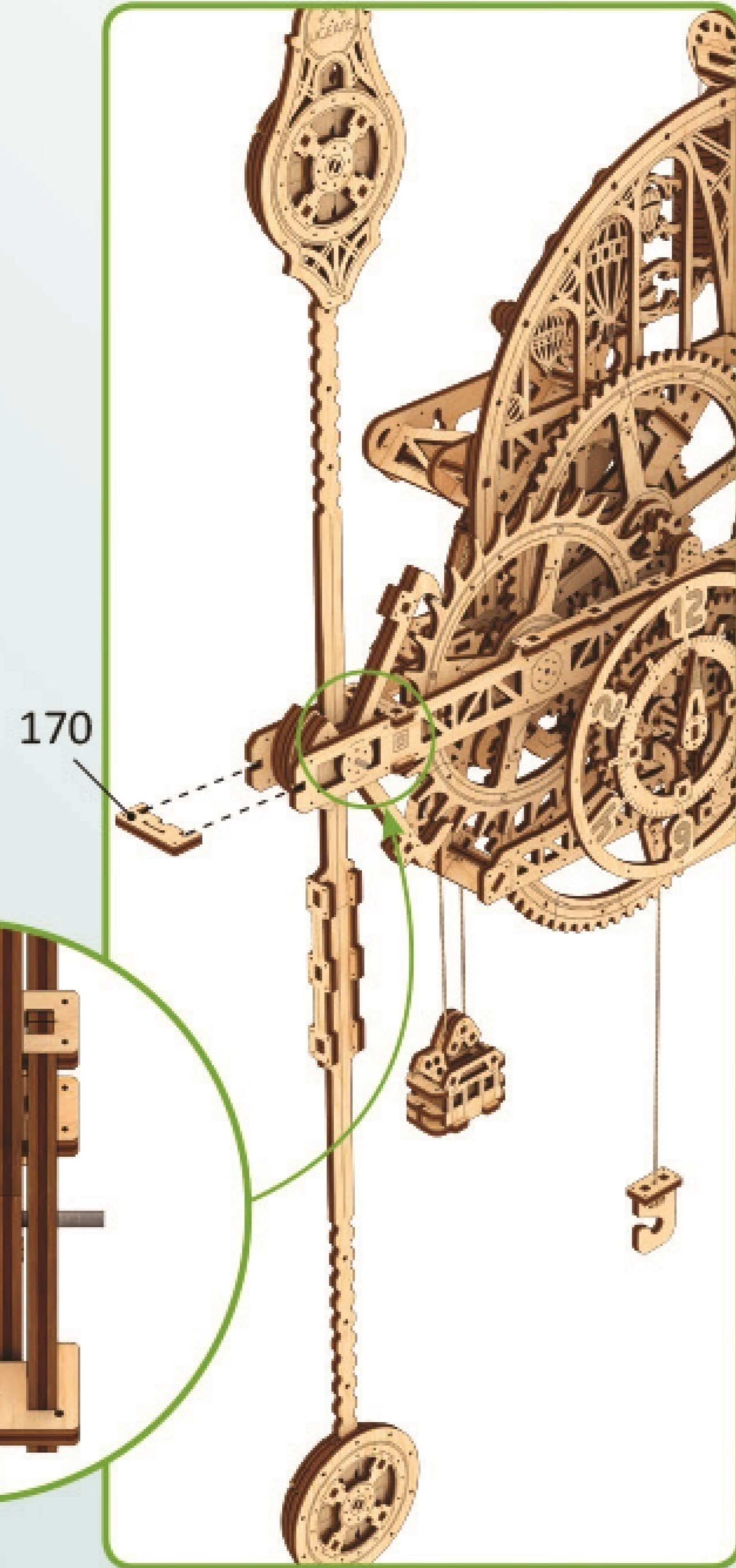
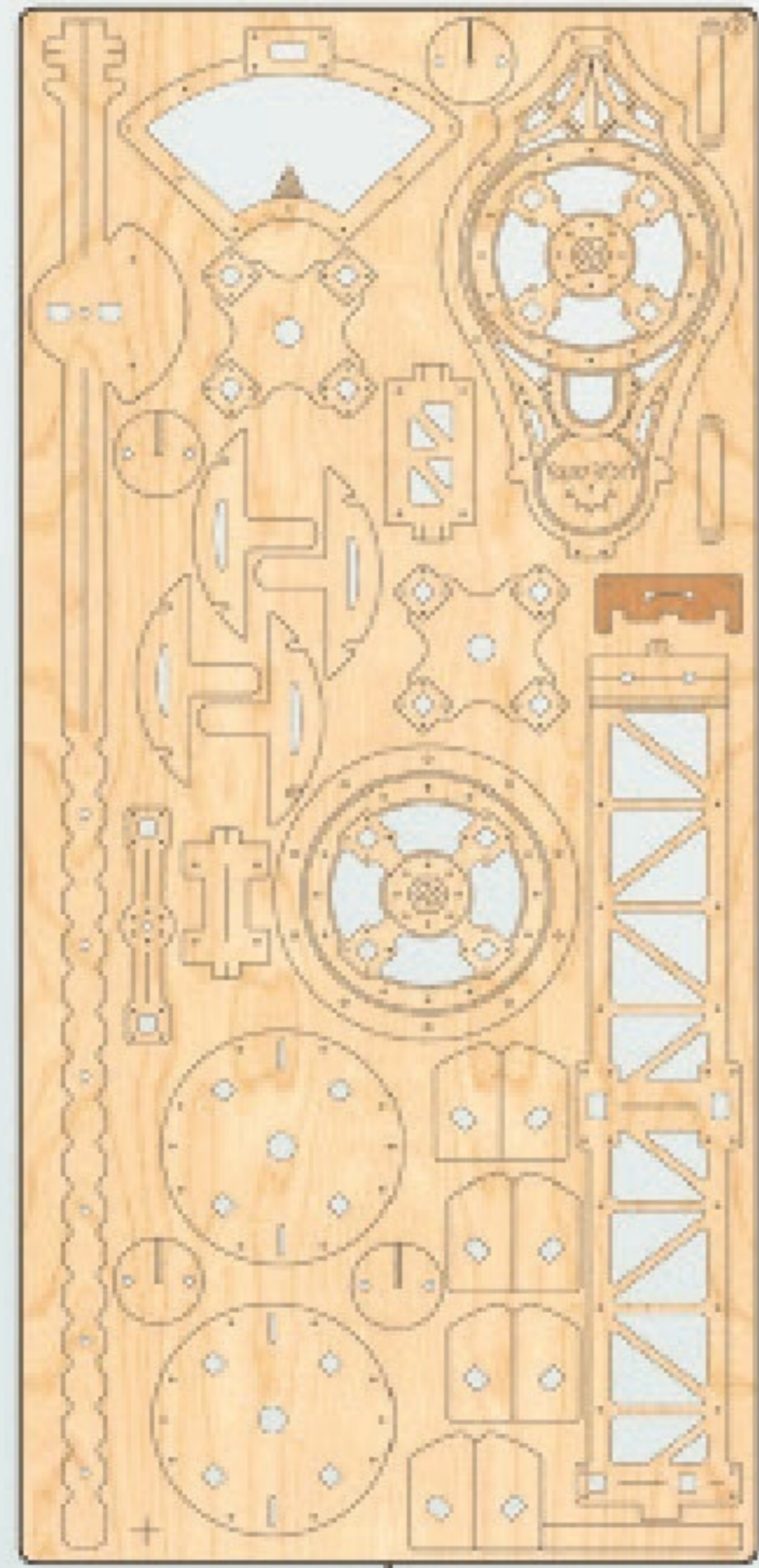

5

U kunt de zak vullen met zand of zout als gewicht.

Aanbevolen gewicht is 2 kg.



1 - Stoffen Zak

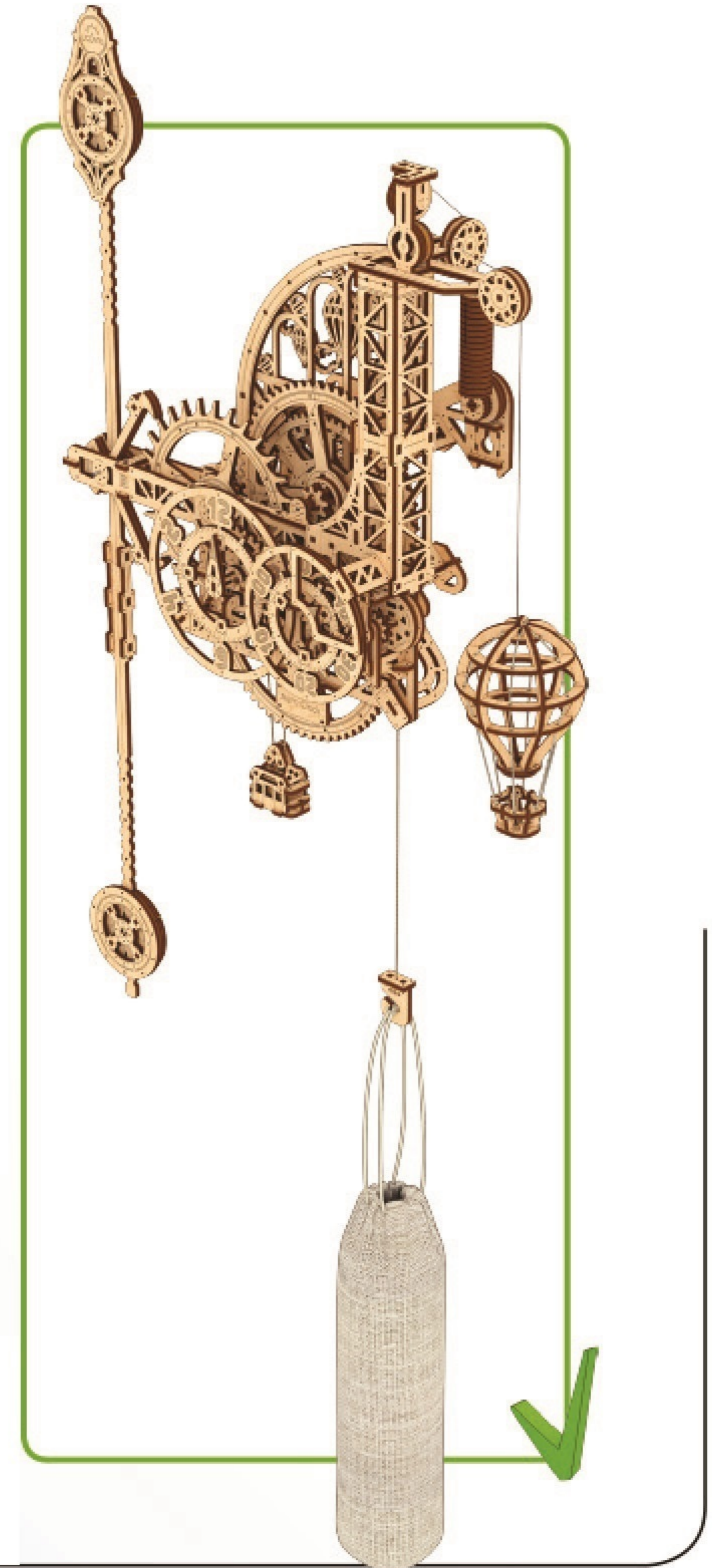

Het opzetten van de ballon. Stel het optimale contragewicht in voor een correcte werking van de ballon. Om dit te doen, voegt of verwijdert u eenvoudig een of meer schijven op het contragewicht. Als het contragewicht correct is, moet de ballon soepel zakken (op dat moment bevindt het contragewicht zich in de hoogst mogelijke positie).

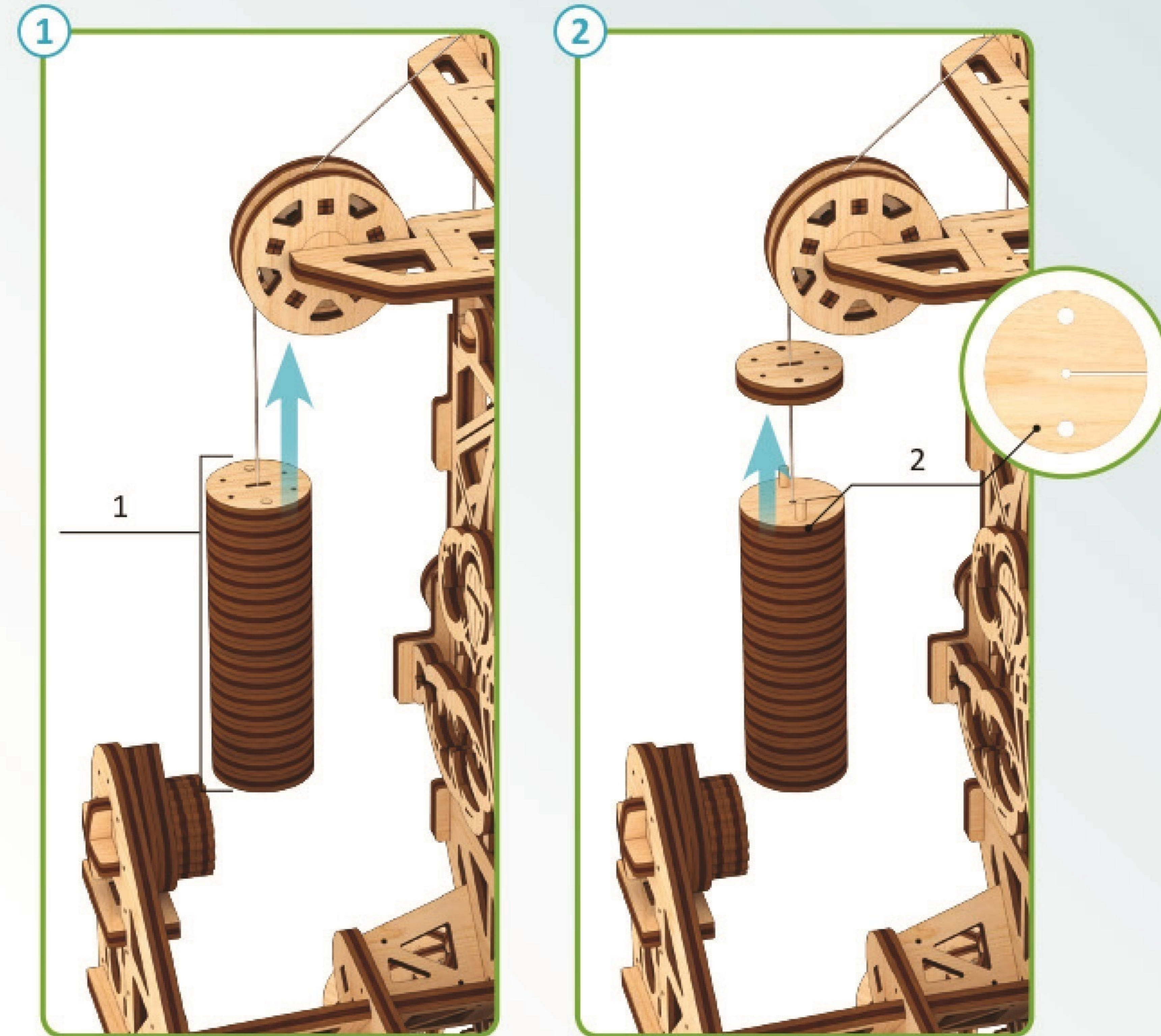

1 - Contragewicht.

2 - Contragewichtschijven (ringen).



3

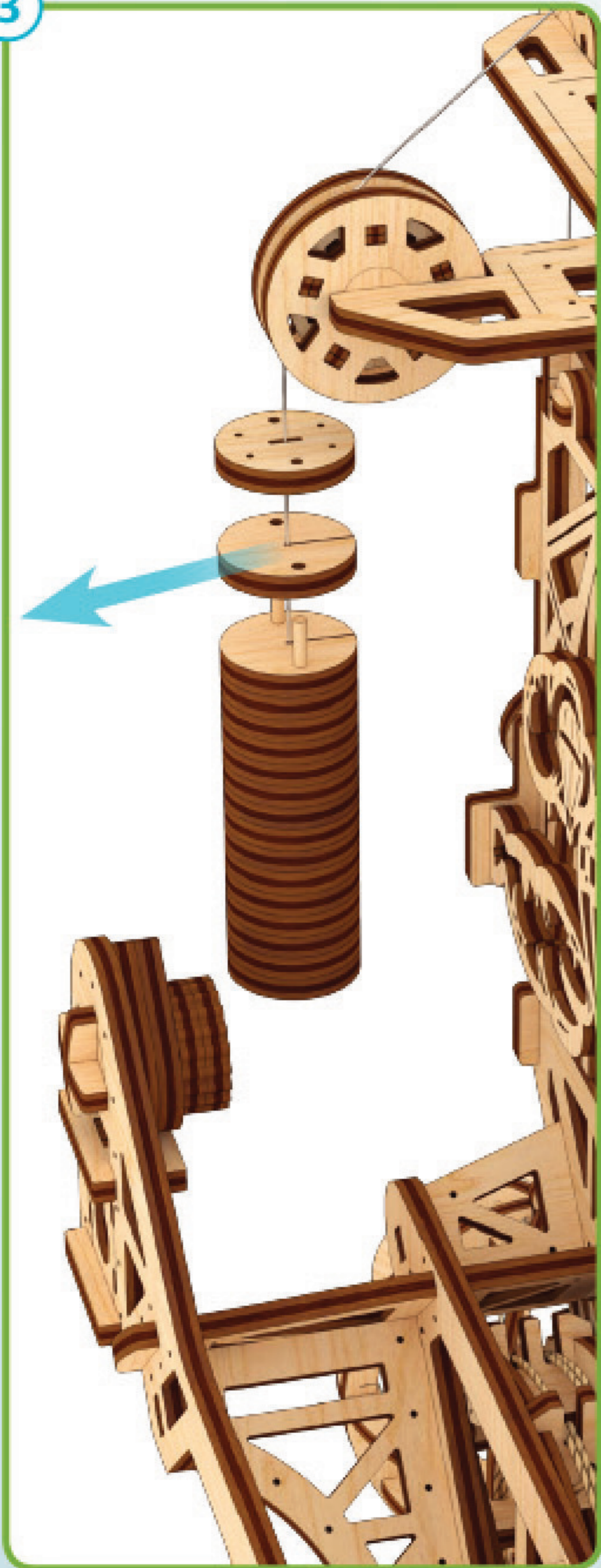

4

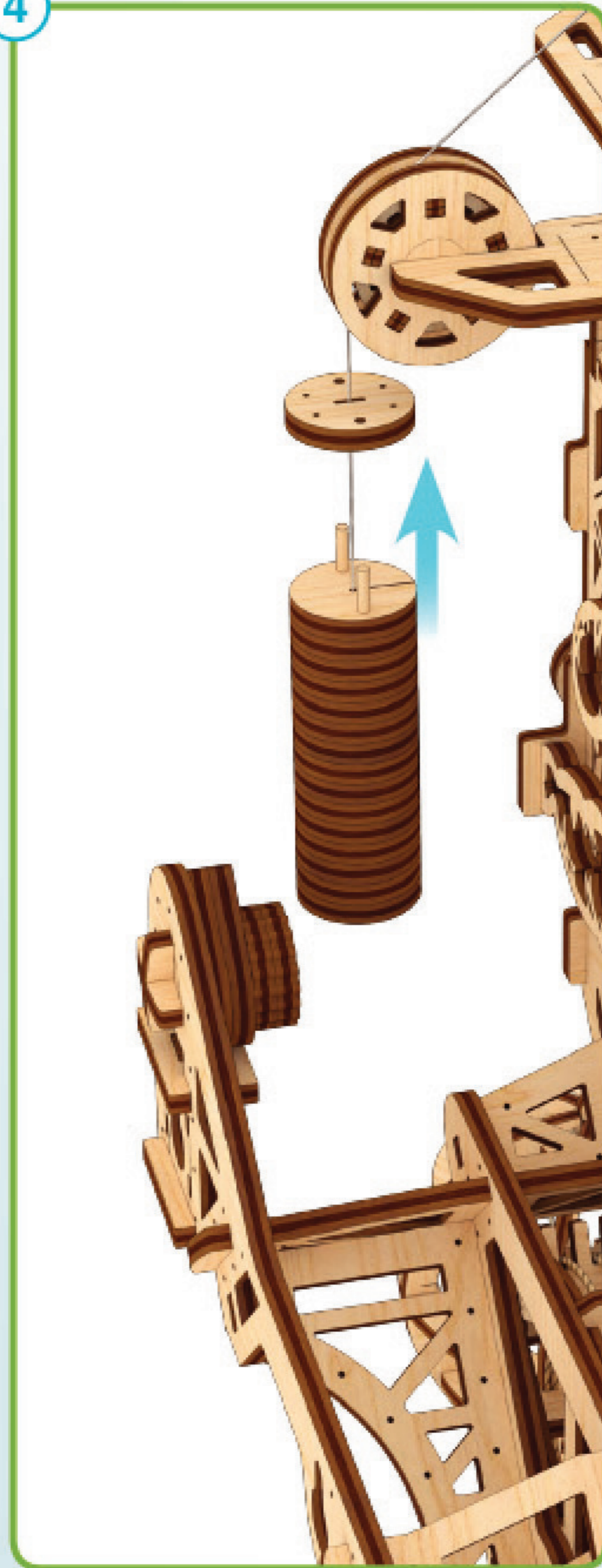

5

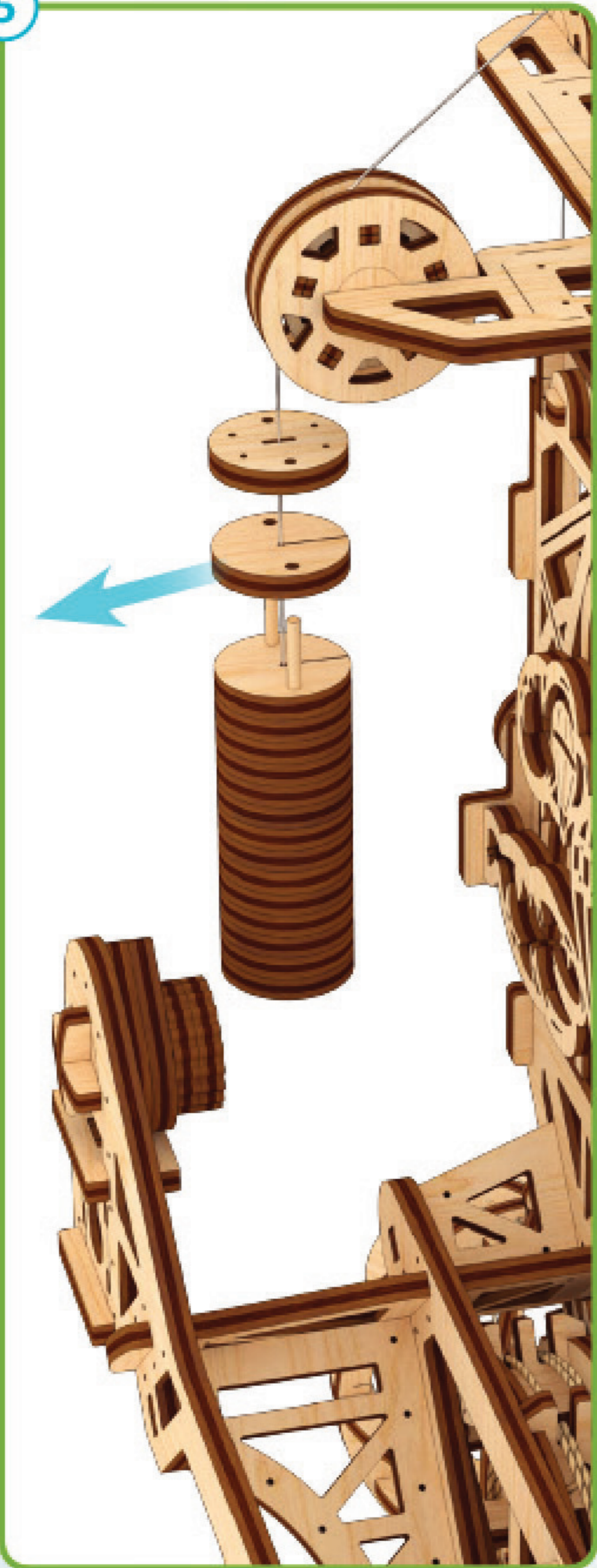

6

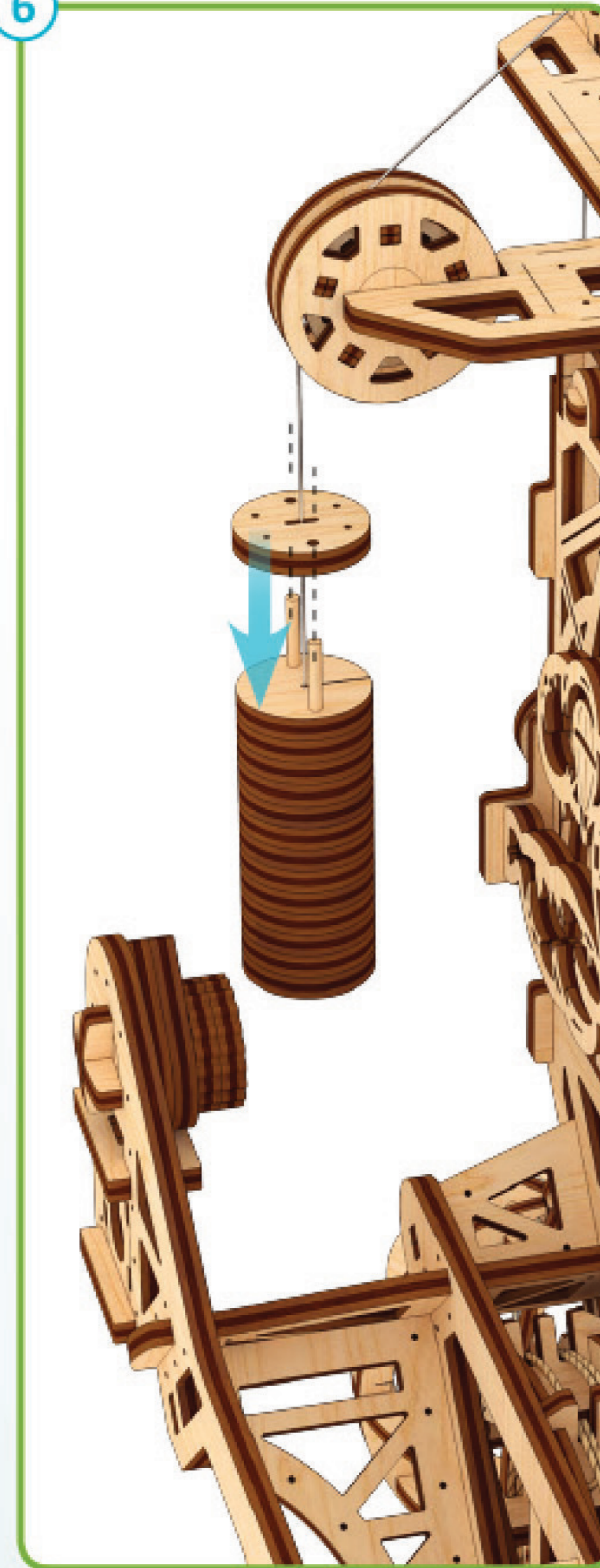

7

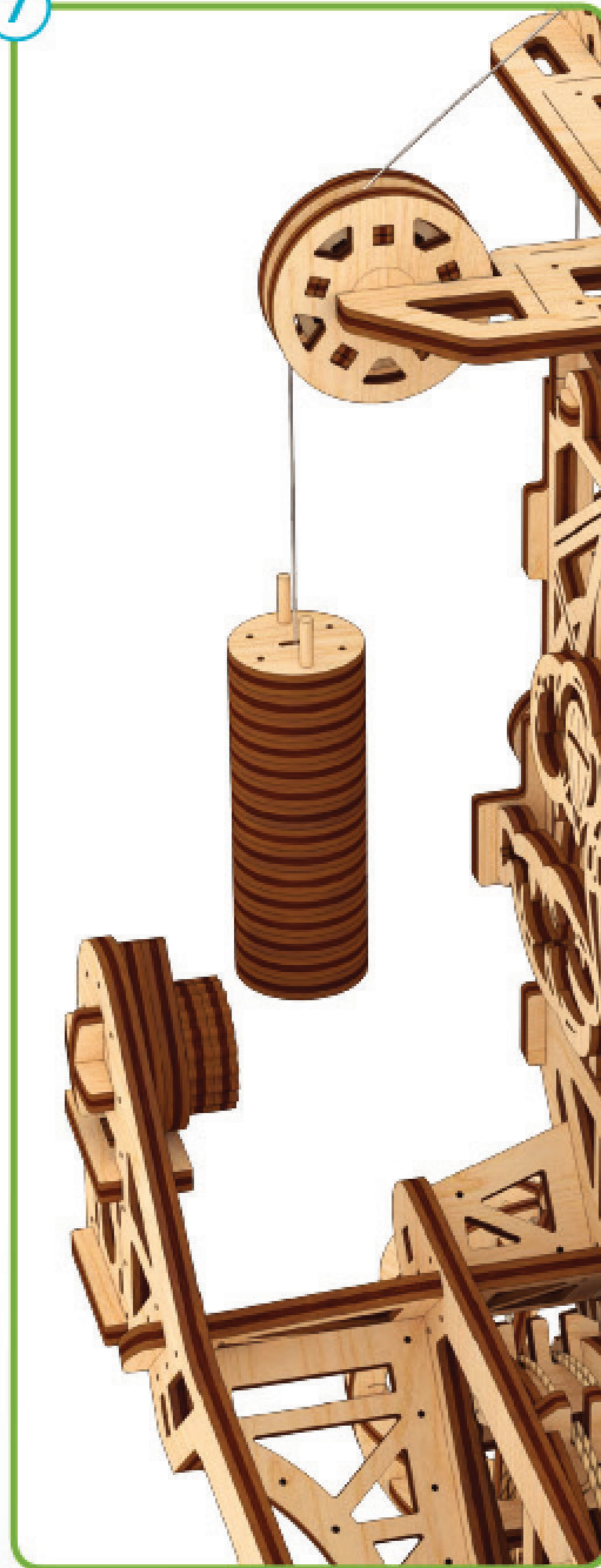

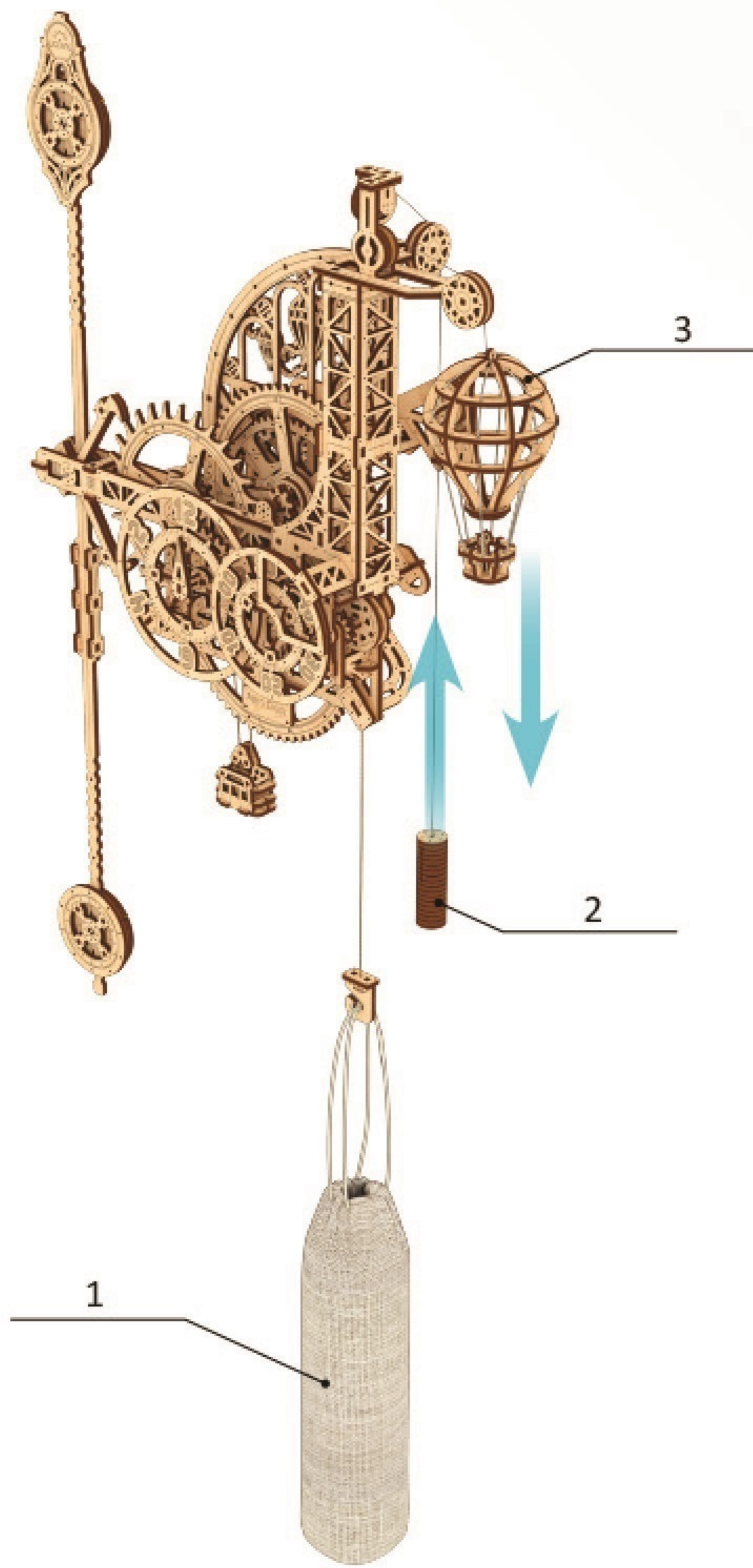

1 - Verzwaarde Zak.

2 - Contragewicht.

3 - Ballon.



### De ballon opzetten.

Als het contragewicht correct is, moet de ballon soepel naar de bodem zakken (op dat moment bevindt het contragewicht zich in de hoogst mogelijke positie).

**Afstellen van de slinger.**

Het wiel moet één volledige omwenteling per minuut draaien. Om dit te bereiken, moet u de juiste locatie van de twee gewichten op de slinger bepalen, door ze omhoog of omlaag te bewegen. Als de klok te snel is, verhoog dan het bovenste gewicht; als het te langzaam gaat, verlaag dan het bodemgewicht.

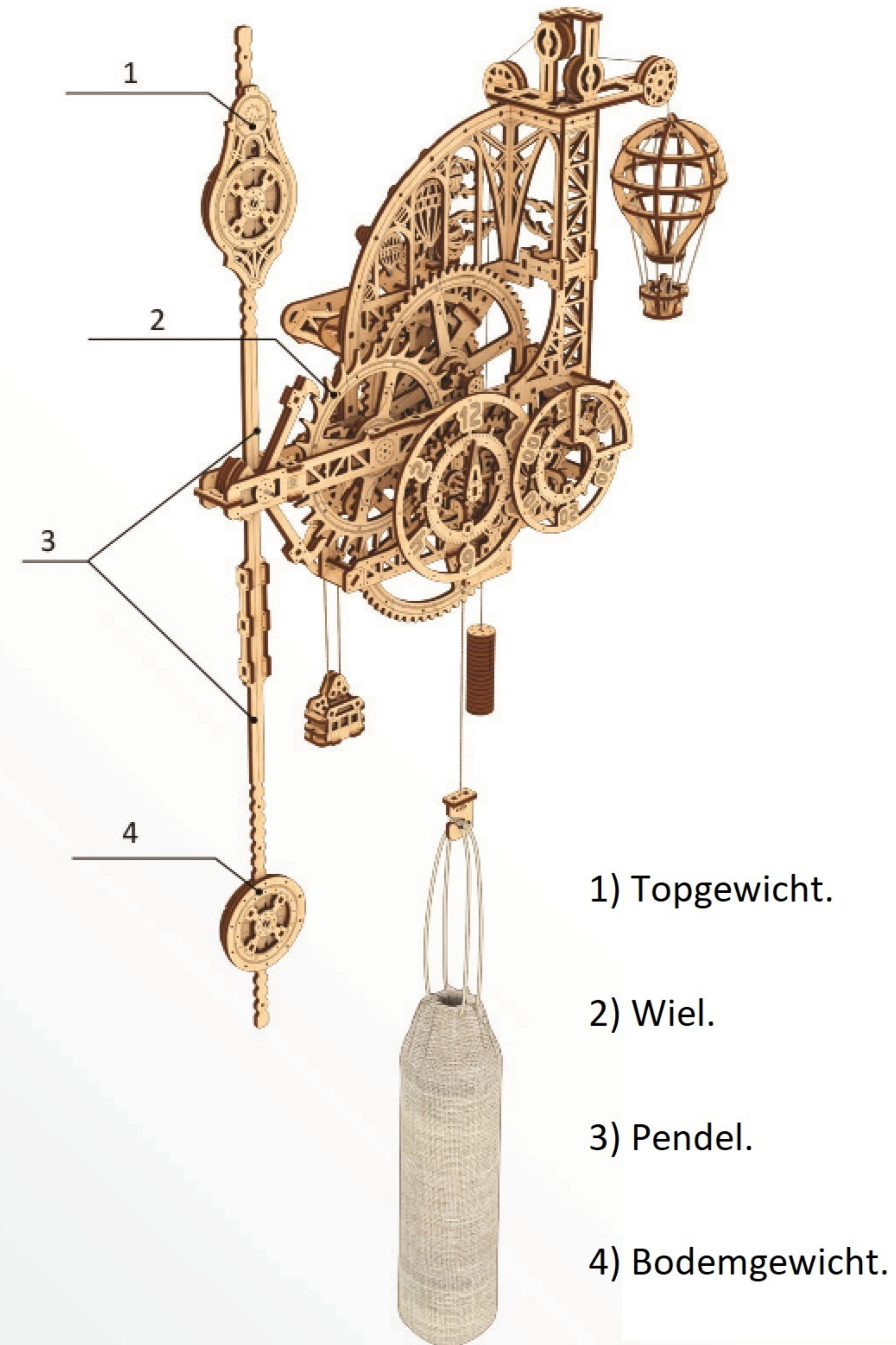



De tijd instellen. Om de juiste tijd in te stellen, draait u de uur- en minutenschijven met de klok mee. Als u bij het instellen van de minutenschijf door de "00"-markering gaat, is het belangrijk om te pauzeren in de "00"-positie zodat de ballon tijd heeft om te dalen. Als de ballon niet daalt wanneer de minutenschijf in de "00"-positie staat, laat hem dan handmatig zakken door hem voorzichtig naar beneden te trekken.



Het losmaken van de ballon. Om de ballon los te maken, tilt u de ontgrendelingshendel omhoog, schuift u de as met het tandwiel en de trommel (de haspel voor de lijn) naar de wijzerplaat en houdt u deze op zijn plaats door de ontgrendelingshendel op de tandwieltanden te laten zakken (zie afbeelding). Om de ballon weer in te schakelen, zet u de ontgrendelingshendel omhoog, schuift u de as met het tandwiel en de trommel naar de muur en laat u de ontgrendelingshendel helemaal naar beneden zakken (de hendel bevindt zich links van het tandwiel).

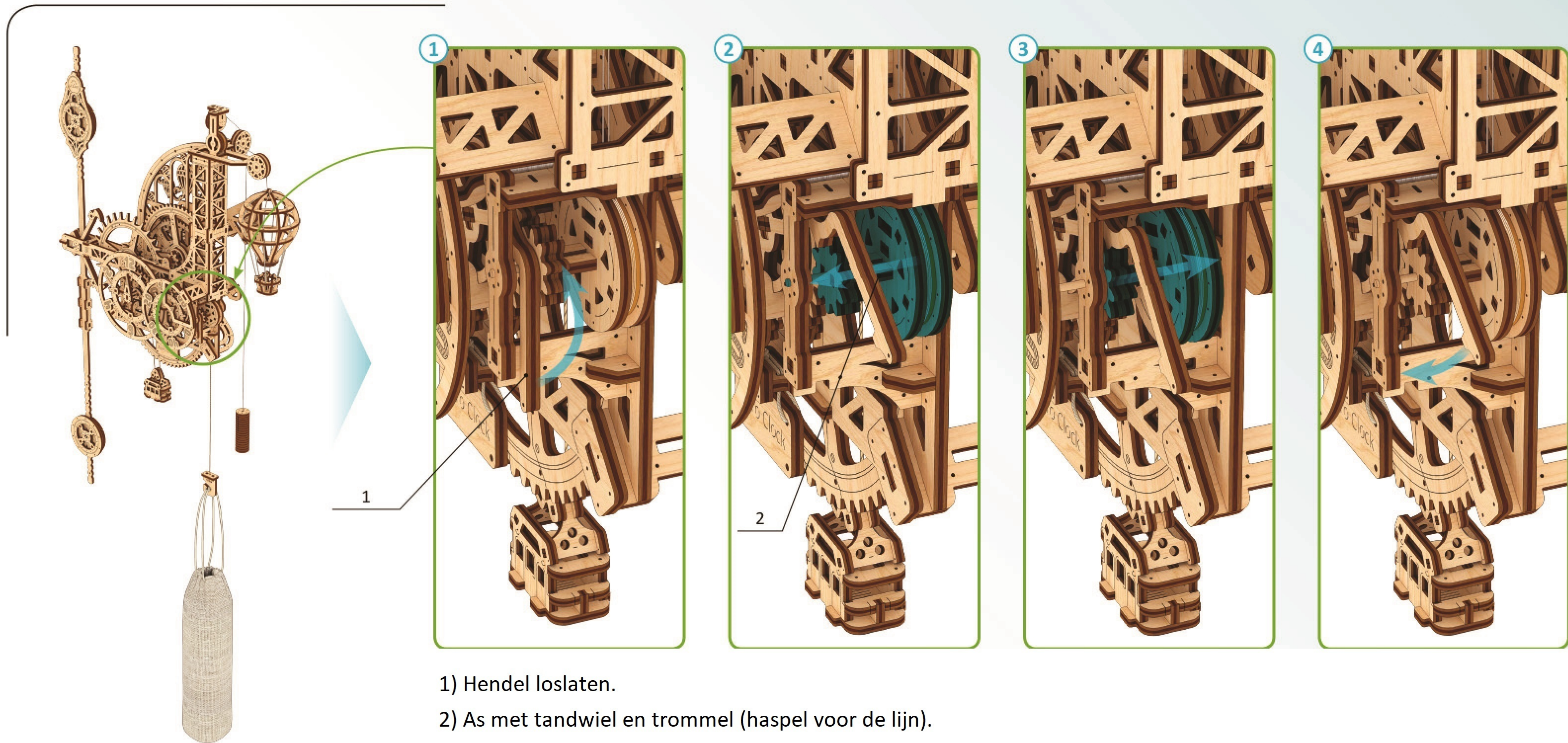

1) Hendel loslaten.

2) As met tandwiel en trommel (haspel voor de lijn).

Als u een fout maakt bij het instellen van de tijd, of als de lijn verstrikt raakt in het mechanisme, ontkoppel dan de ballon (zie "De ballon losmaken" hieronder) voordat u de tijd opnieuw instelt of de lijn ontwart (de lijn weer door alle rollers halen, Als u klaar bent om de tijd opnieuw in te stellen, draait u de minutenschijf naar de "00"-positie, schakelt u de ballon opnieuw in met de ontgrendelingshendel, laat u de ballon voorzichtig zakken en plaatst u de minutenschijf. Belangrijk: sluit de ballon alleen weer aan als de minutenschijf in de "00"-stand staat, anders kan het mechanisme vastlopen.

1

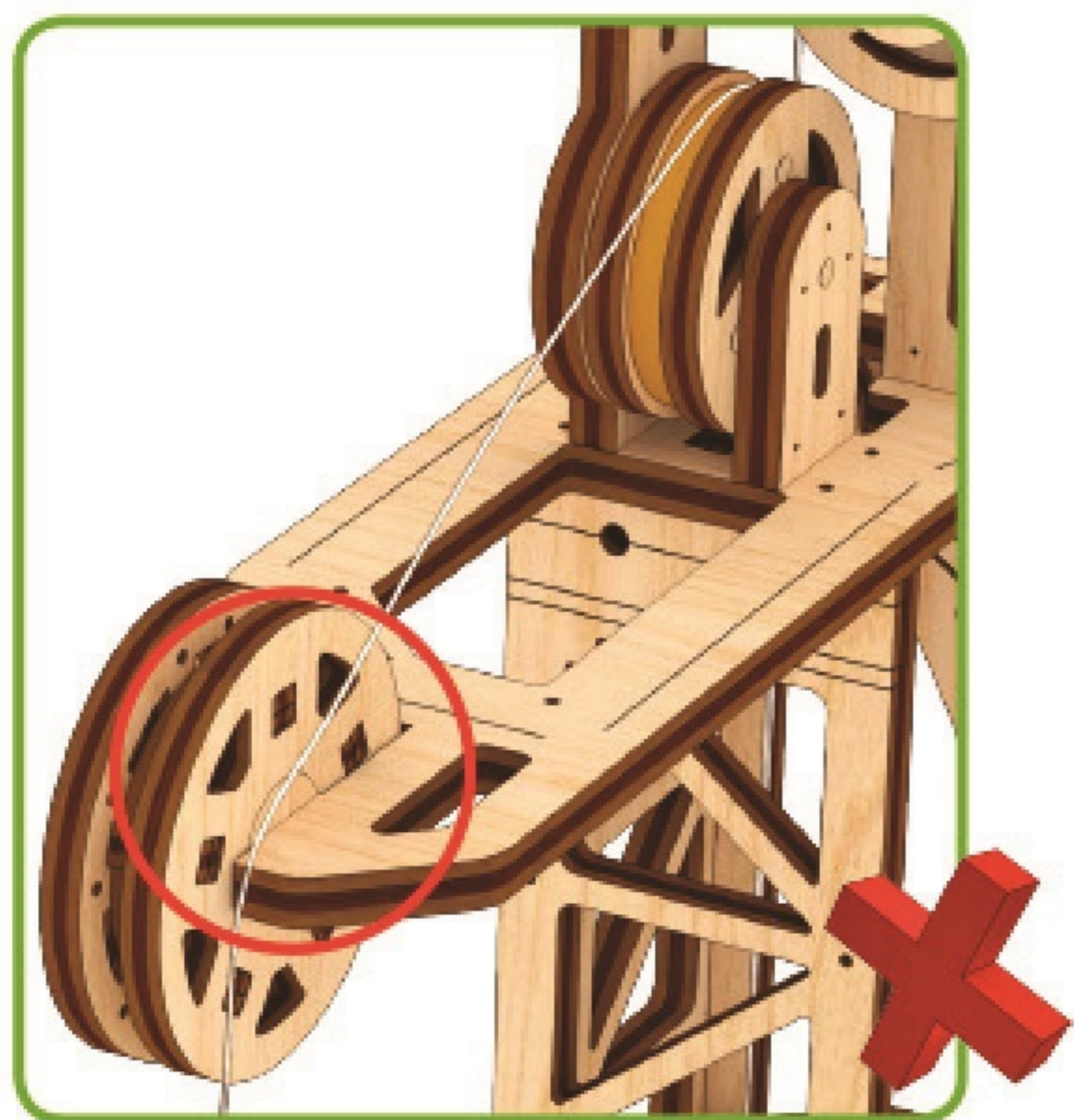
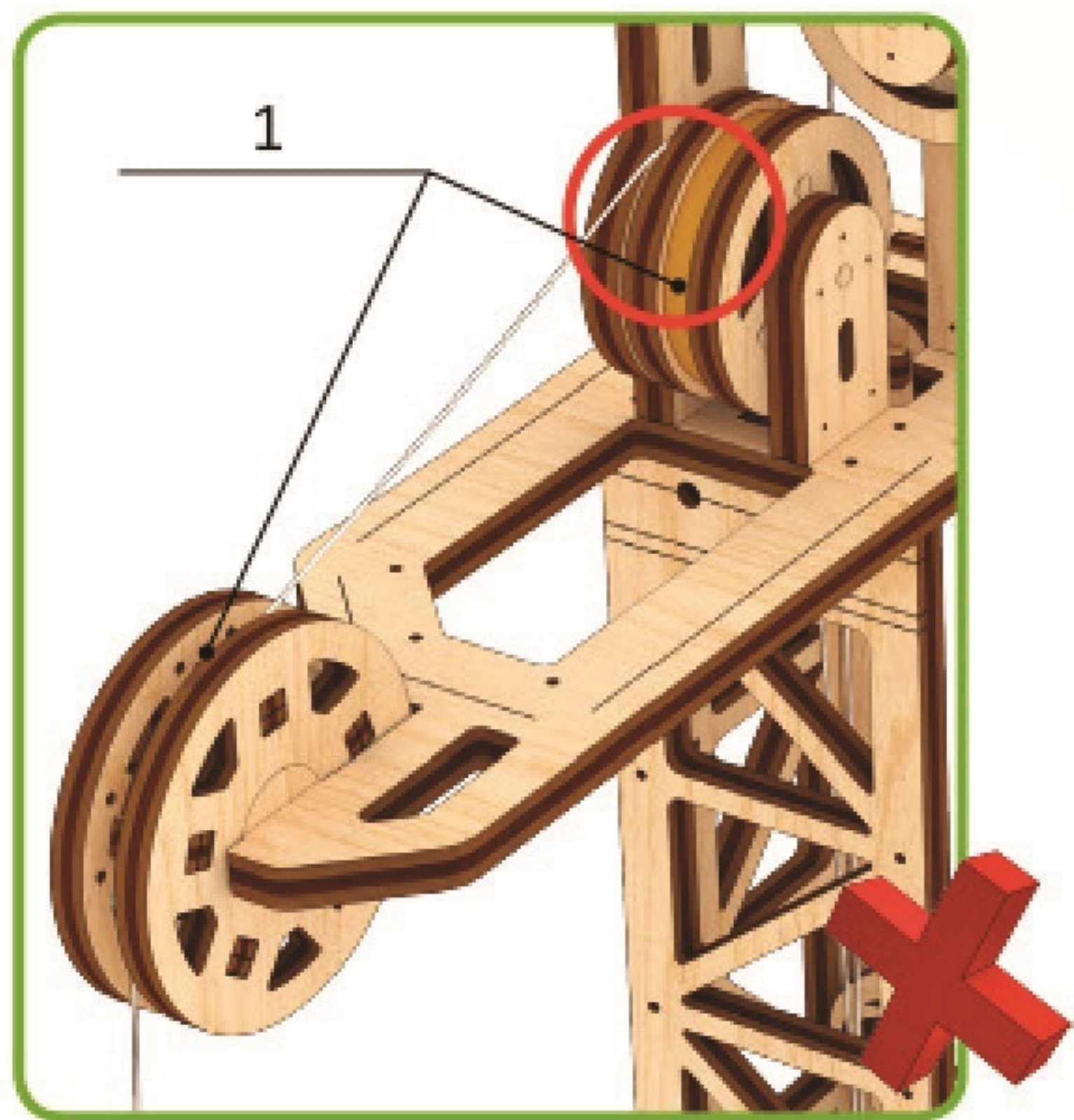

2

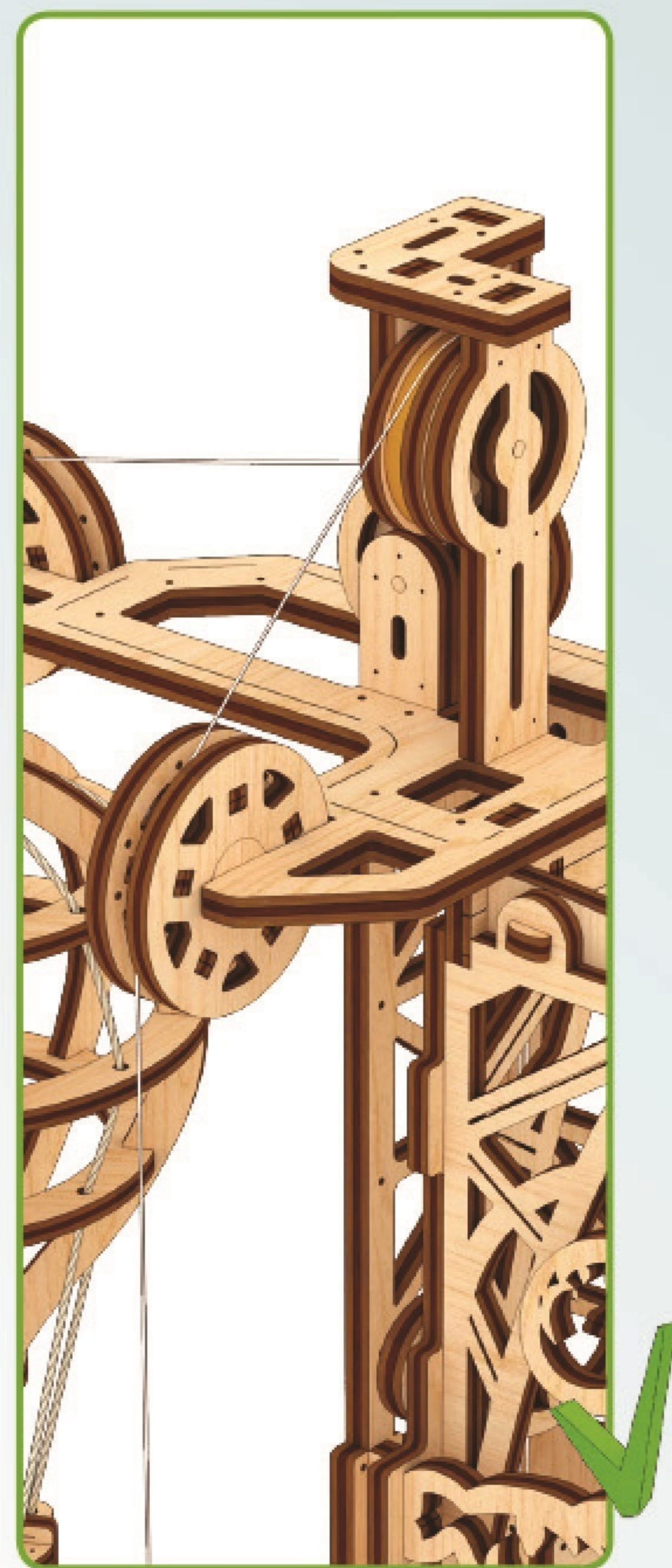
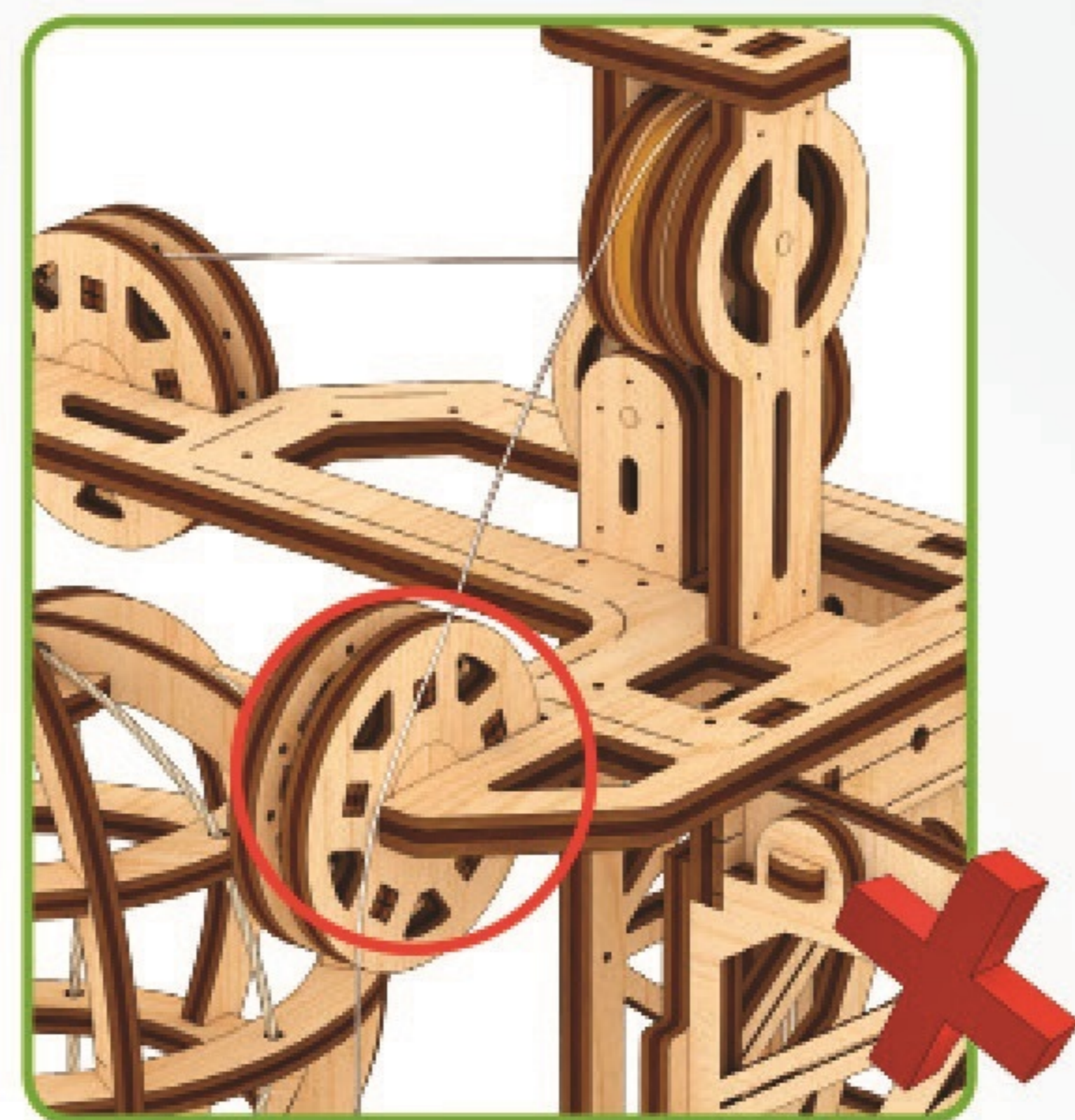
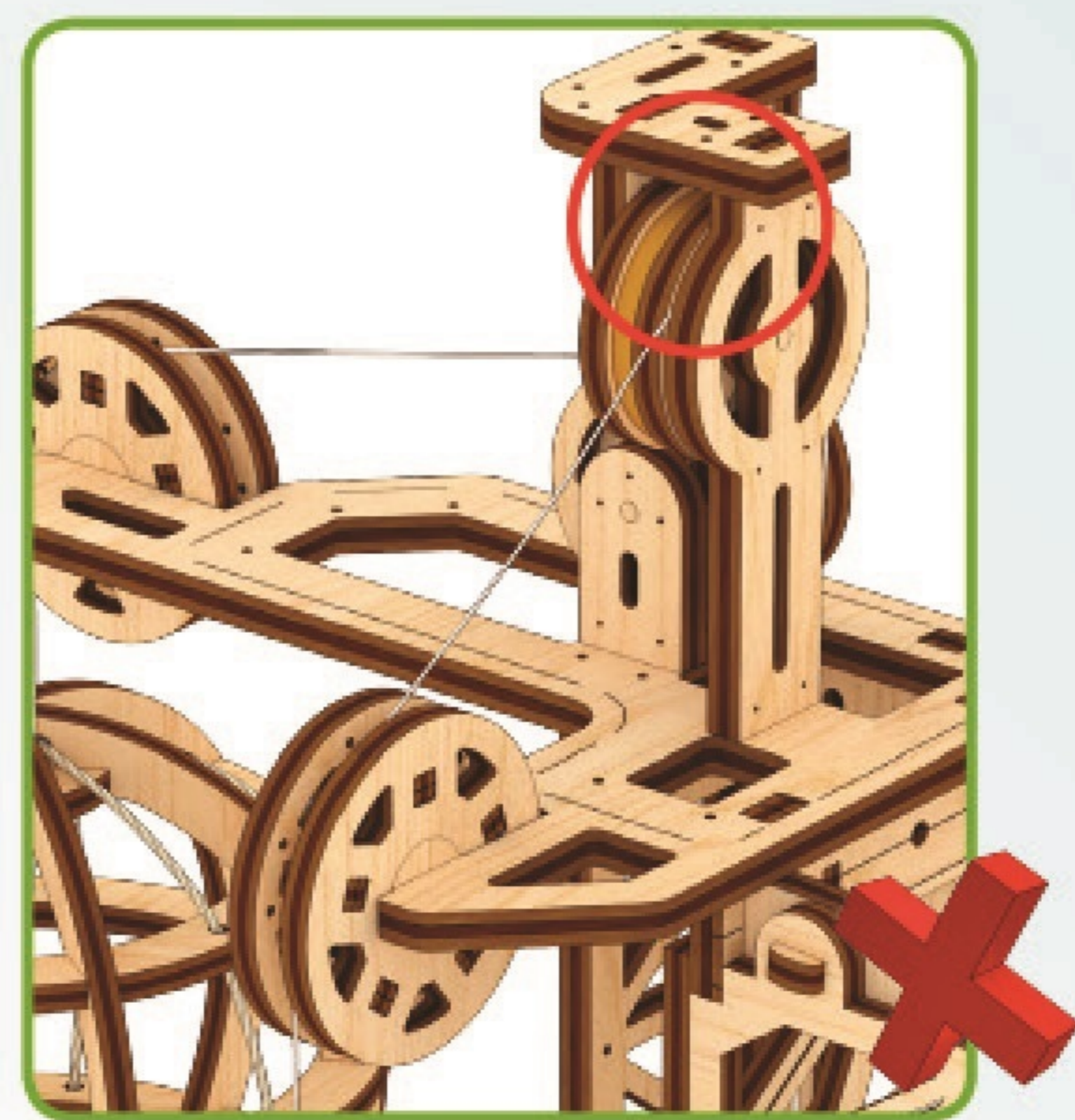

1 - Rollers

3



4

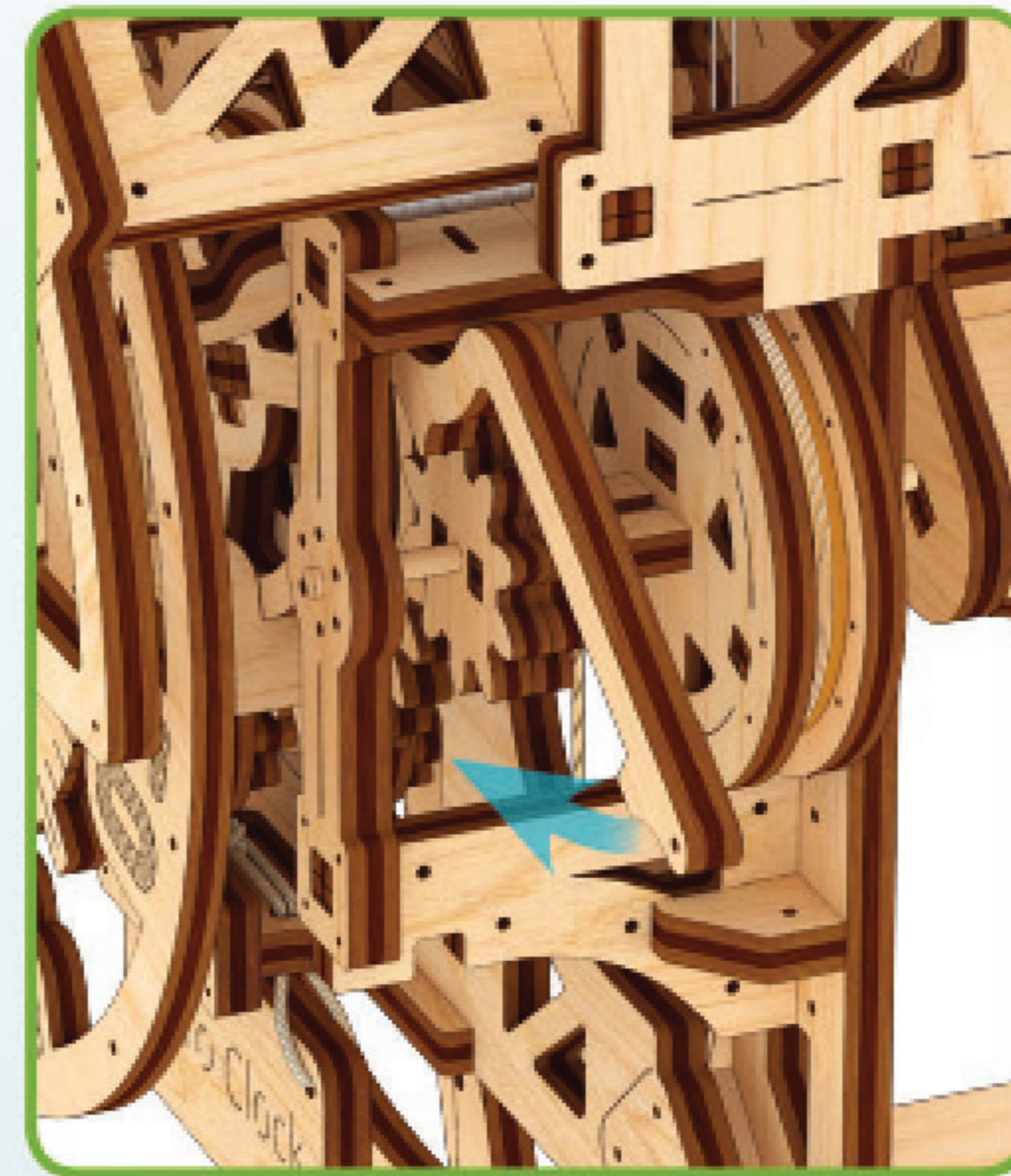
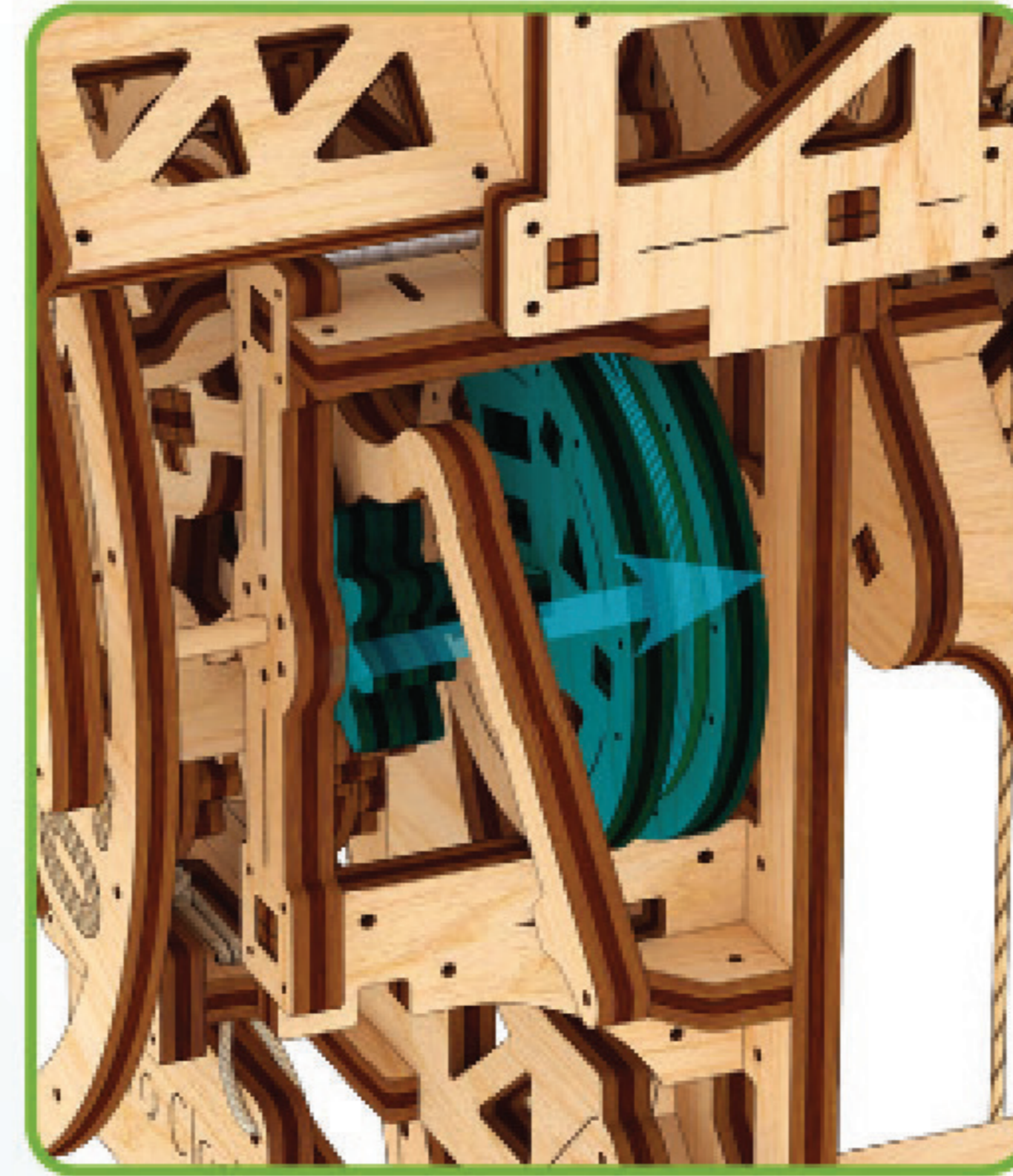

5

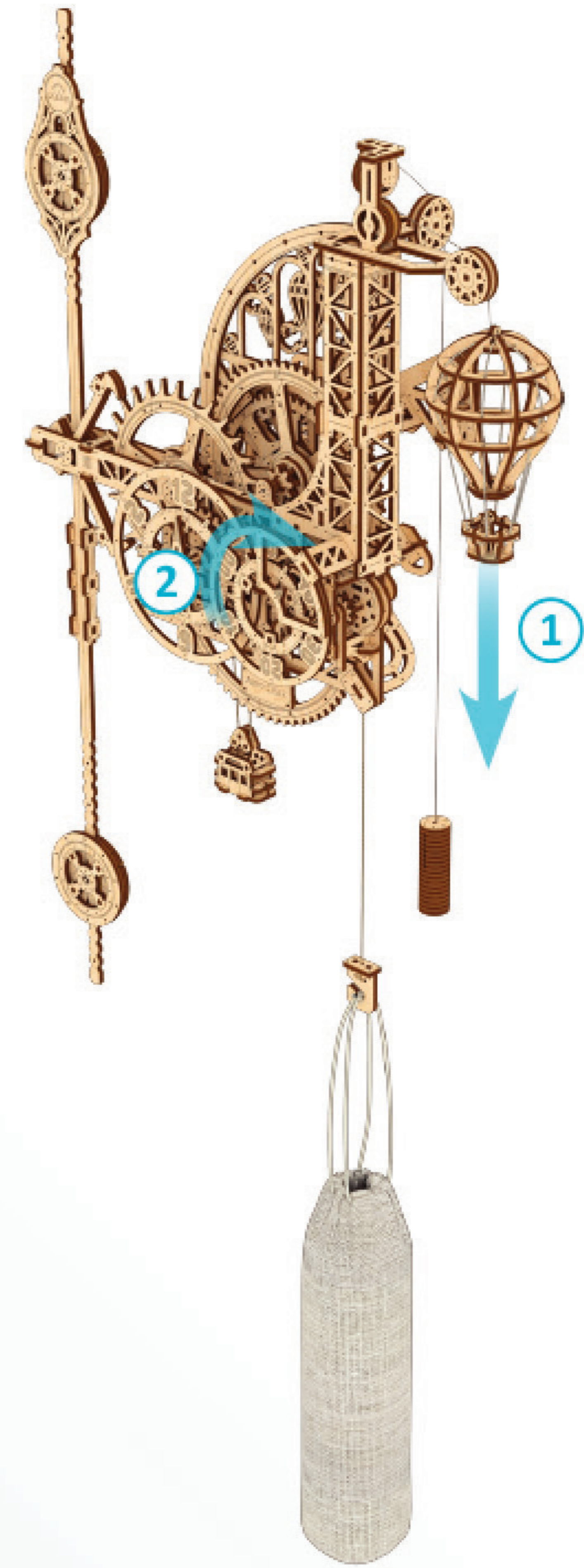

Nadat de verzwaarde zak is neergedaald, moet de klok opnieuw worden opgewonden. Om dit te doen, trekt u met uw linkerhand één kant van het gewaxte koetskoord naar beneden, terwijl u de verzwaarde tas met uw rechterhand ondersteunt en optilt.

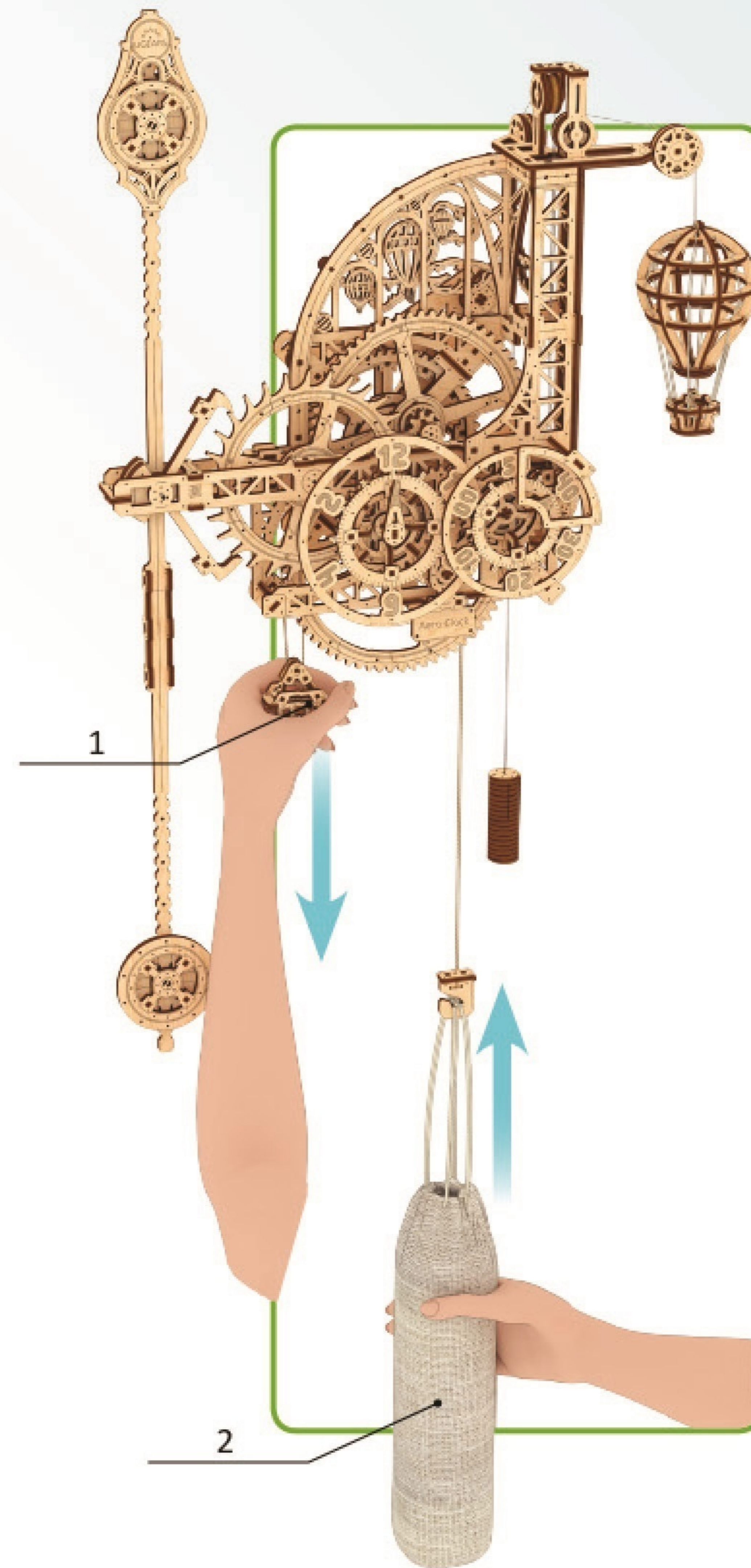

1) Vervoer.

2) Gewogen Zak.

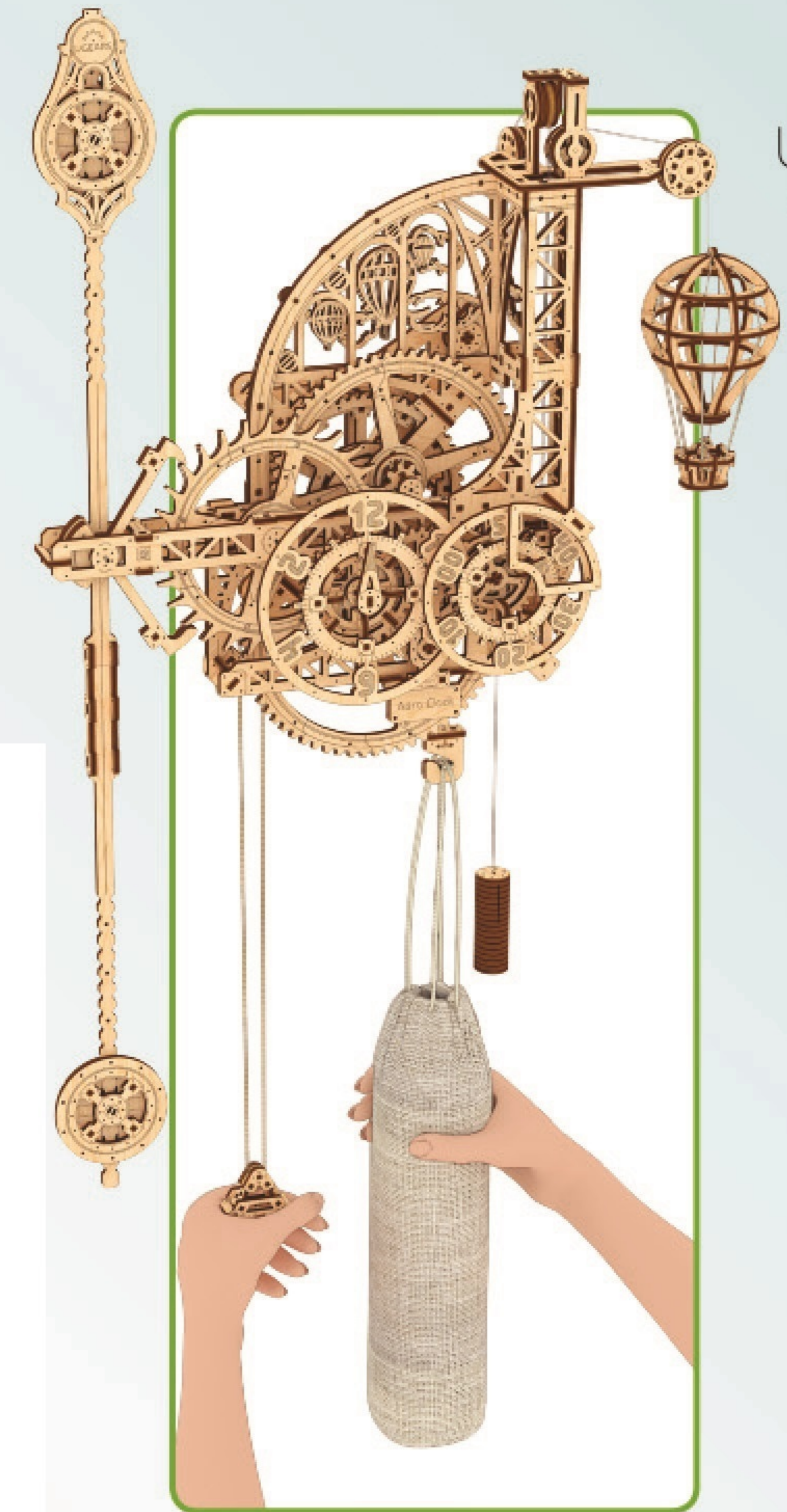

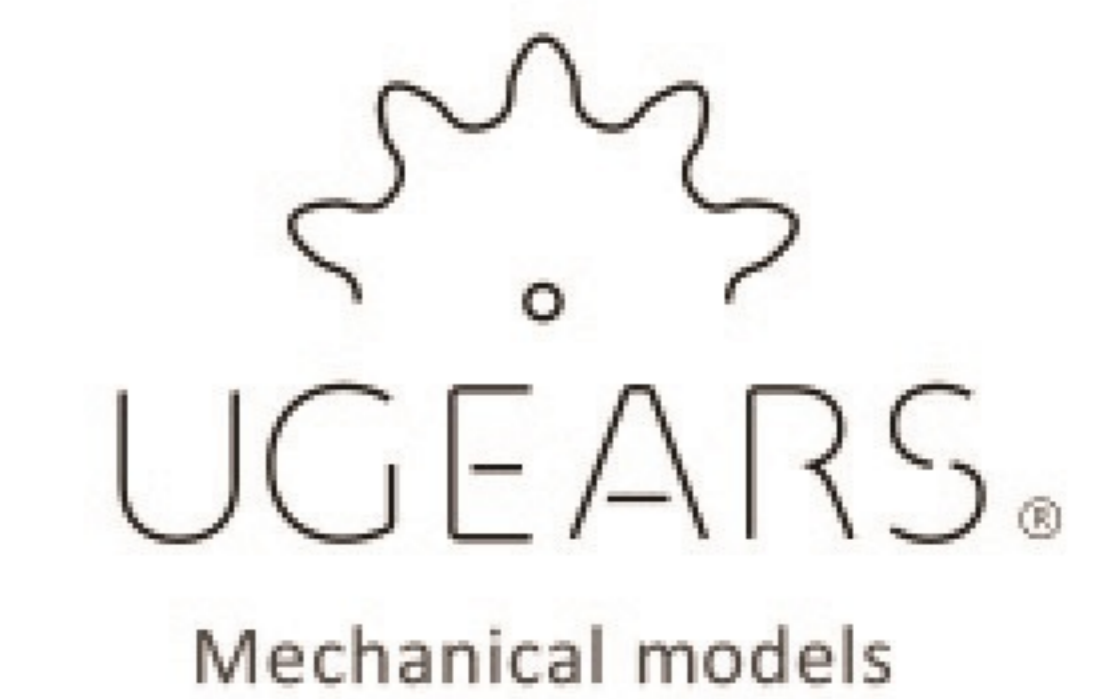
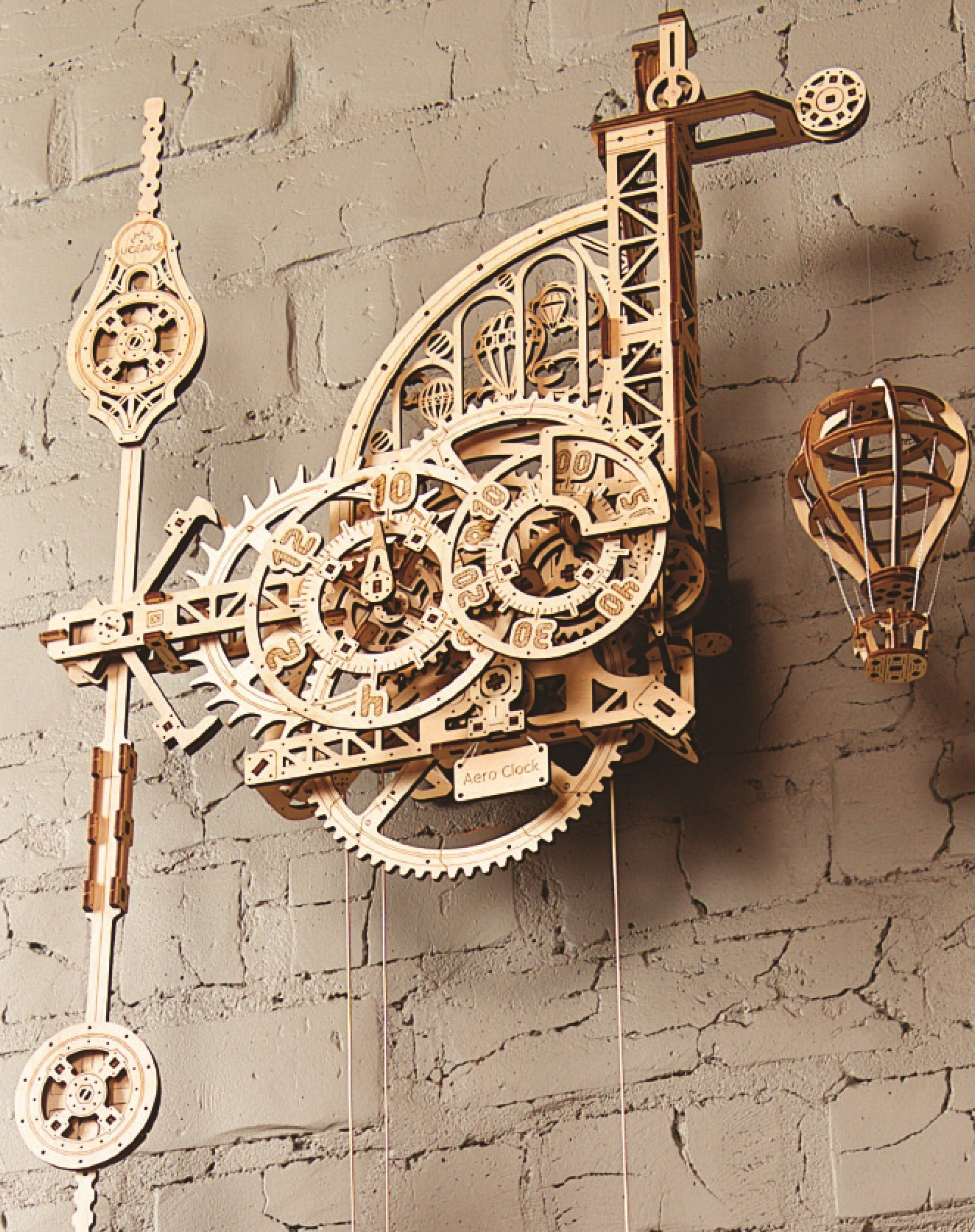

Bedankt voor de deelname  
aan deze reis met ons.

[ugears-shop.nl](http://ugears-shop.nl)

Klantenservice

[info@ugears-shop.nl](mailto:info@ugears-shop.nl)