

Assemble Me. Treasure Me



Find out MORE

  
UGEAR'S®  
Mechanical models

## "Schatkist"

DEU Modell «Schatulle mit Geheimfach». FRA Modèle «Boîte à secret». POL Model «Skrzynka skarbów». SPA Modelo «La caja con el secreto». ITA Modello «Scatola con segreto». TUR Model «Sürpriz kutusu». RUS Модель «Шкатулка с секретом». KOR 비밀 박스. CHI 秘密木匣”模型.

## Handleiding in het Nederlands

DEU Aufbauanleitung. FRA Notice d'assemblage. POL Instrukcja montażu. SPA Instrucciones de montaje. ITA Istruzioni di montaggio. TUR Kurulum talimatı. RUS Инструкция по сборке. KOR 조립 설명서. CHI 装配说明书



NATURAL  
Made from wood materials

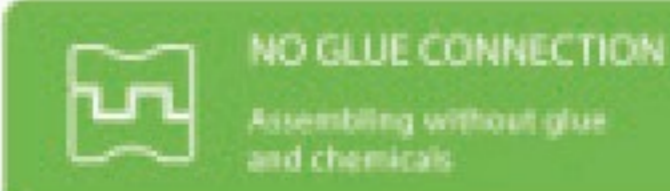

NO GLUE CONNECTION  
Assembling without glue and chemicals



SELF ASSEMBLY  
Details are already cut and ready to assemble



MECHANICAL  
The models produce motion



EDUCATIONAL  
Perfect for family projects through hands-on STEM learning

## NED

### Bouwinstructies.

Verwijder de onderdelen van de borden zoals hieronder is geïllustreerd. Pas op dat de onderdelen niet breken. Wanneer het niet loskomt, gebruik dan voorzichtig een mesje. Dit model bouwt u zelf zonder gebruik te maken van lijm. Wanneer onderdelen moeilijk te plaatsen zijn. Smeer deze dan in met een kaars. Om frictie te voorkomen behandelt u ook alle beweegbare onderdelen met een kaars.

### Waarschuwing!



Gebruik geen kaars die brand!



Opgepast, de spieën zijn scherp!

## Pictogrammen.



Smeer het onderdeel in met kaarsvet.



Snijd dwarsstukken voordat u het onderdeel van het bord verwijdert.



Opgelet! Controleer de goede positie.



Druk de onderdelen aan zover als ze willen gaan.



Reserveonderdelen.



Overtuig u ervan dat de onderdelen goed zijn uitgelijnd met de andere onderdelen voor u ze goed aandrukt.



Herhaal de stap maar dan gespiegeld.



Dit is geen onderdeel. Het is een gereedschap voor meting en montage. Leder model heeft z'n eigen gereedschap.

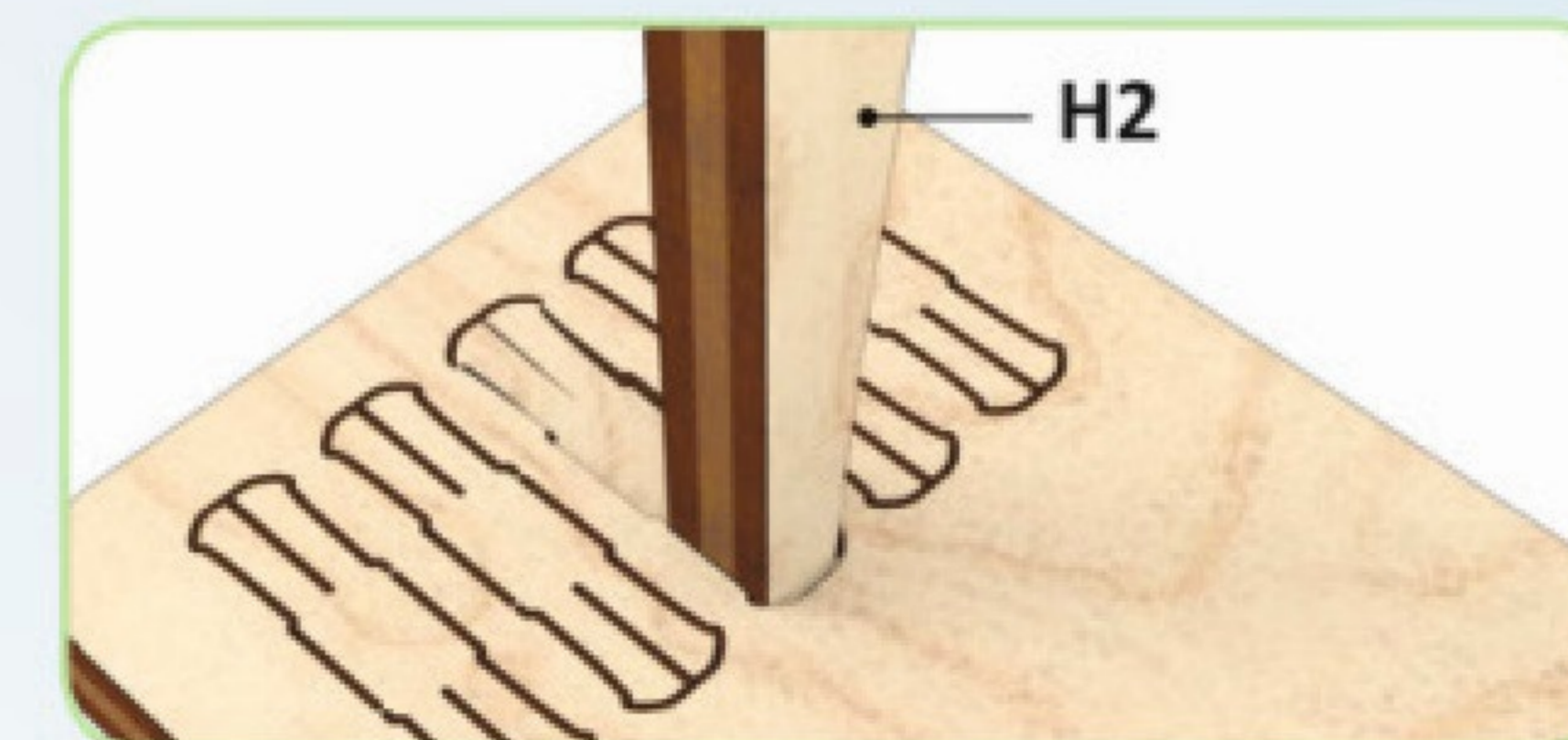
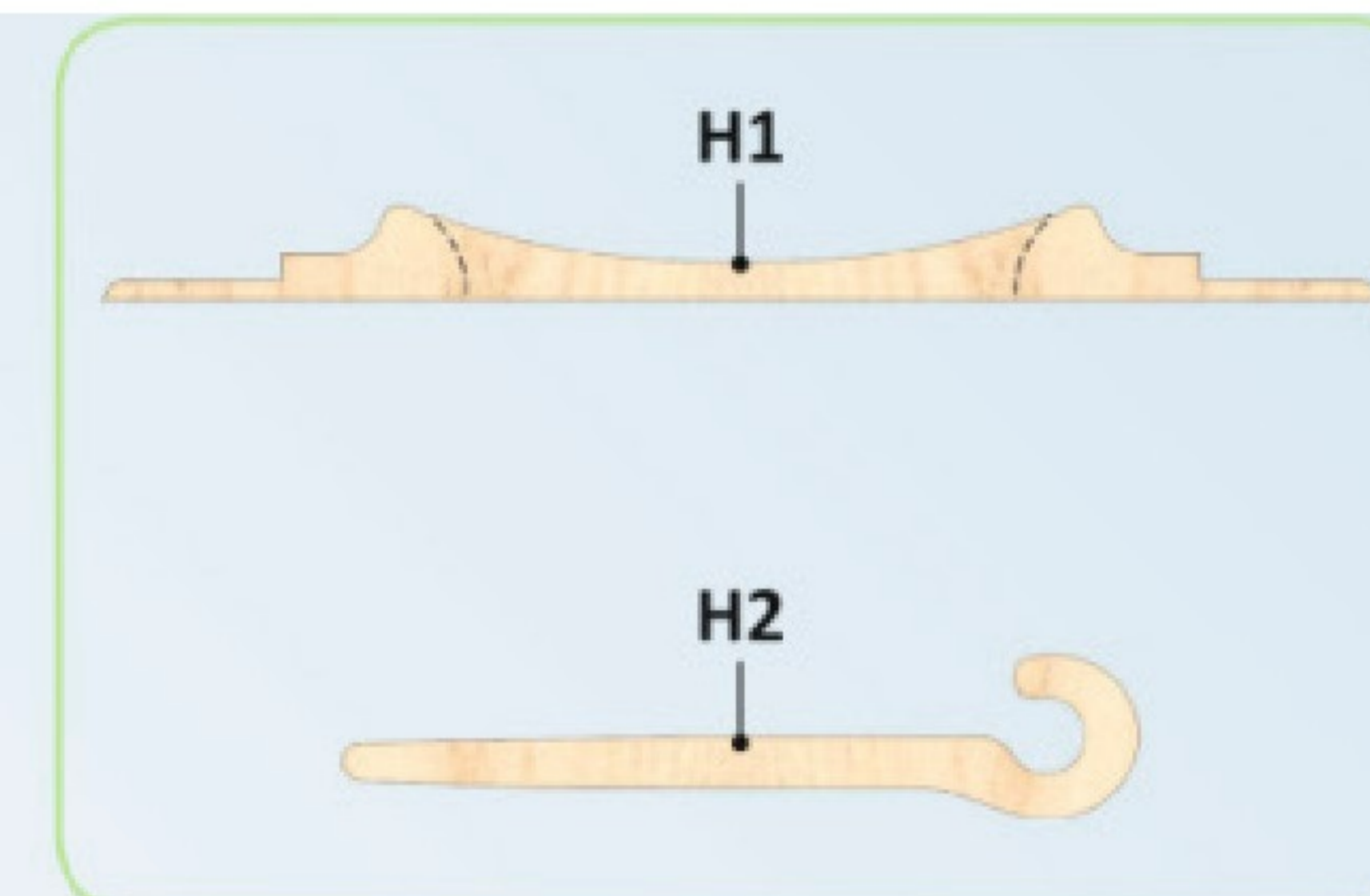
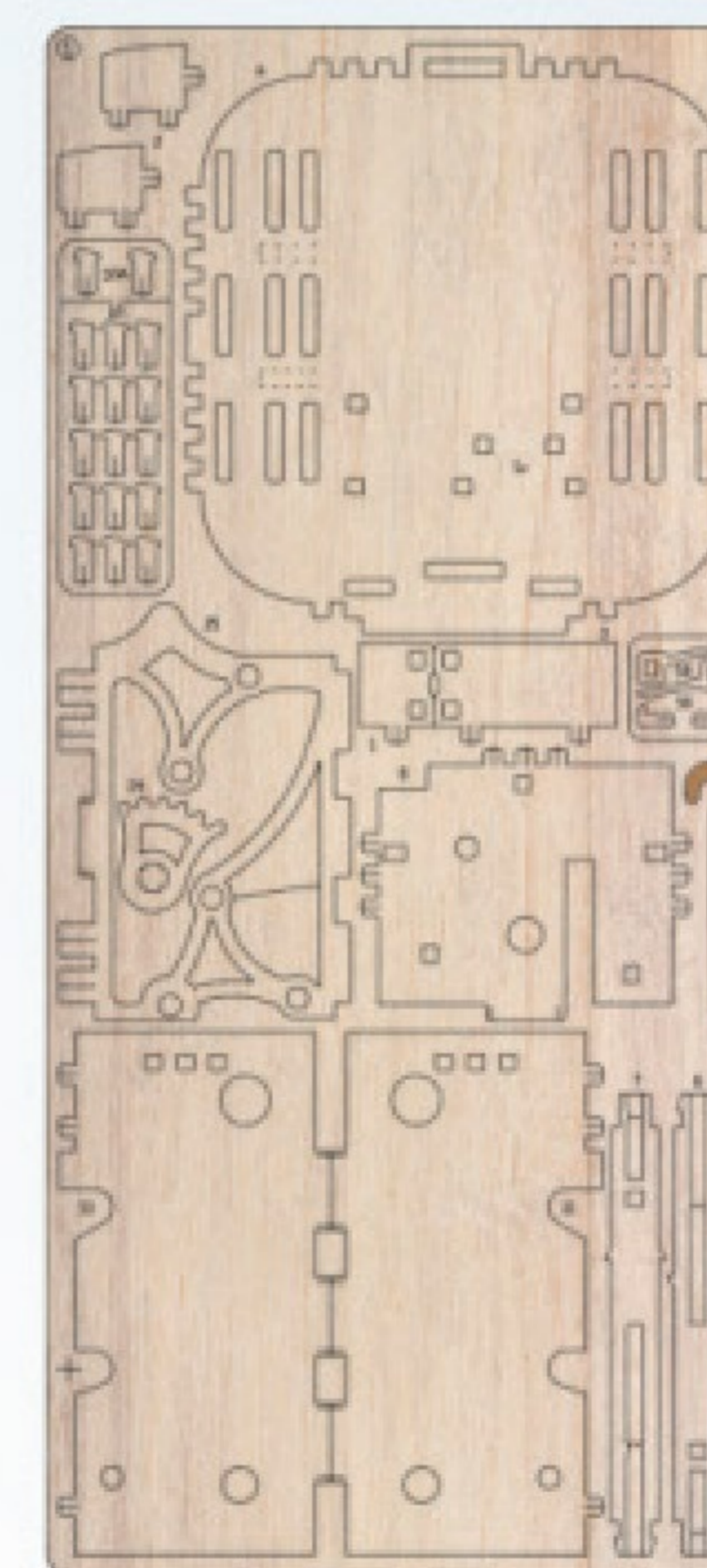

Mechanical models

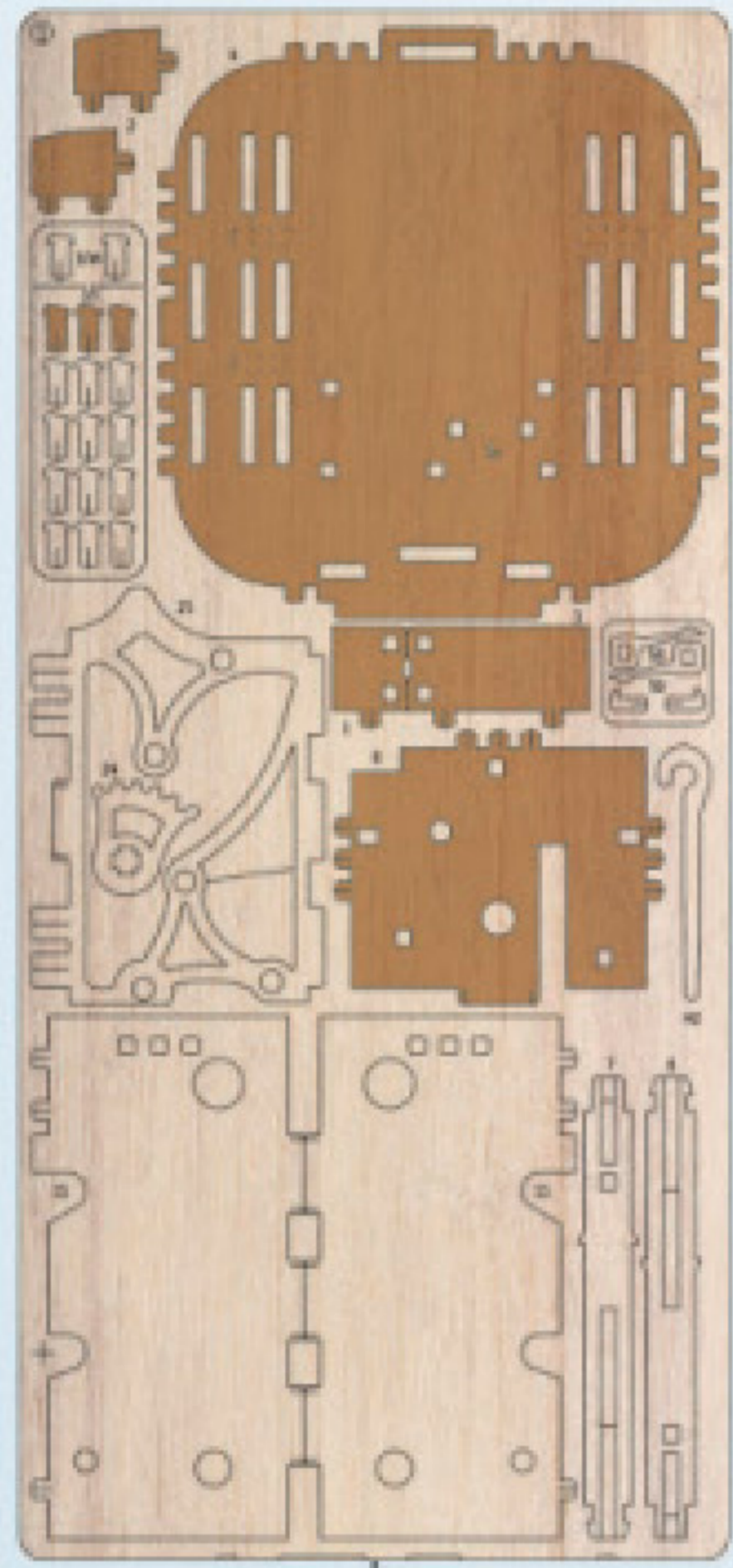

①

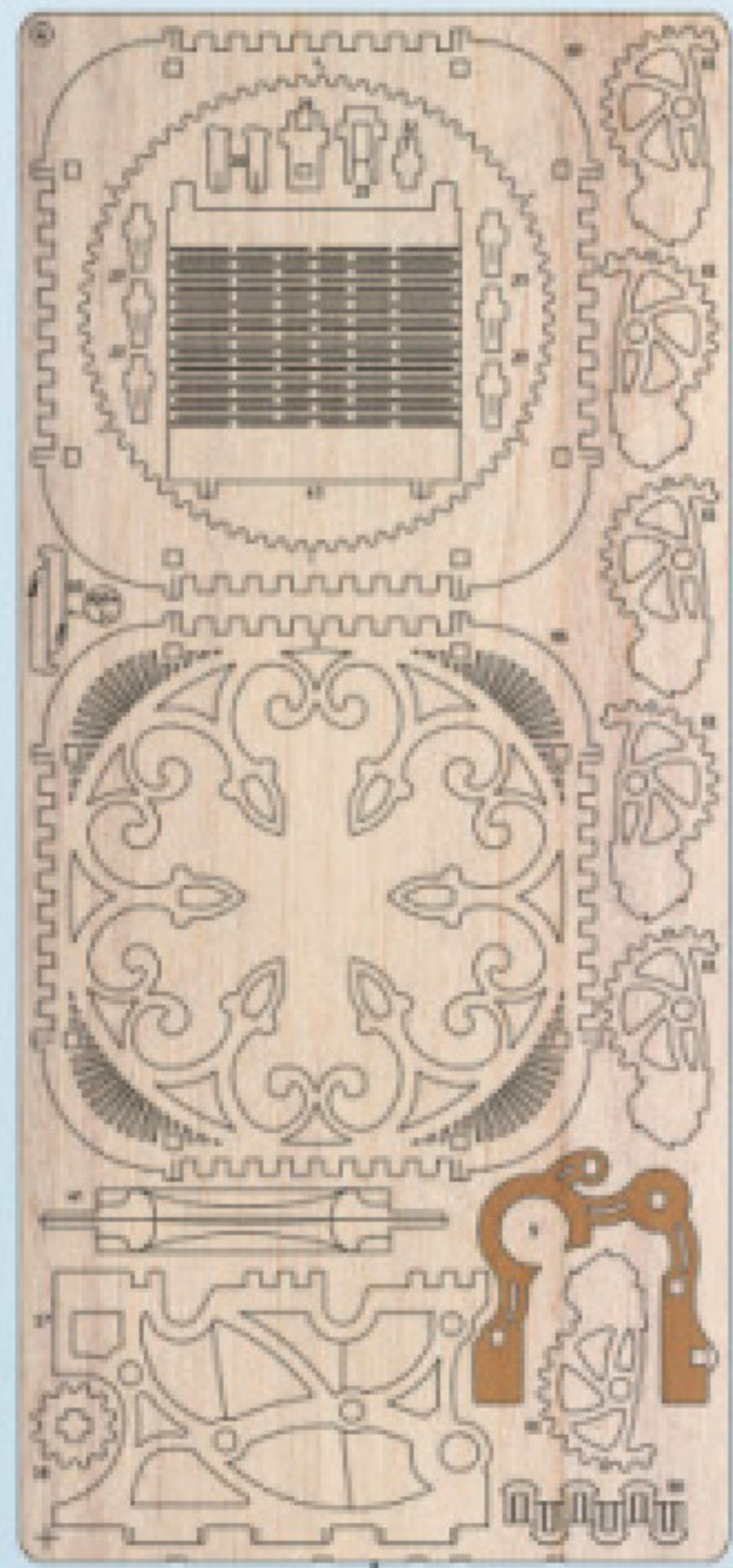

④

④

1

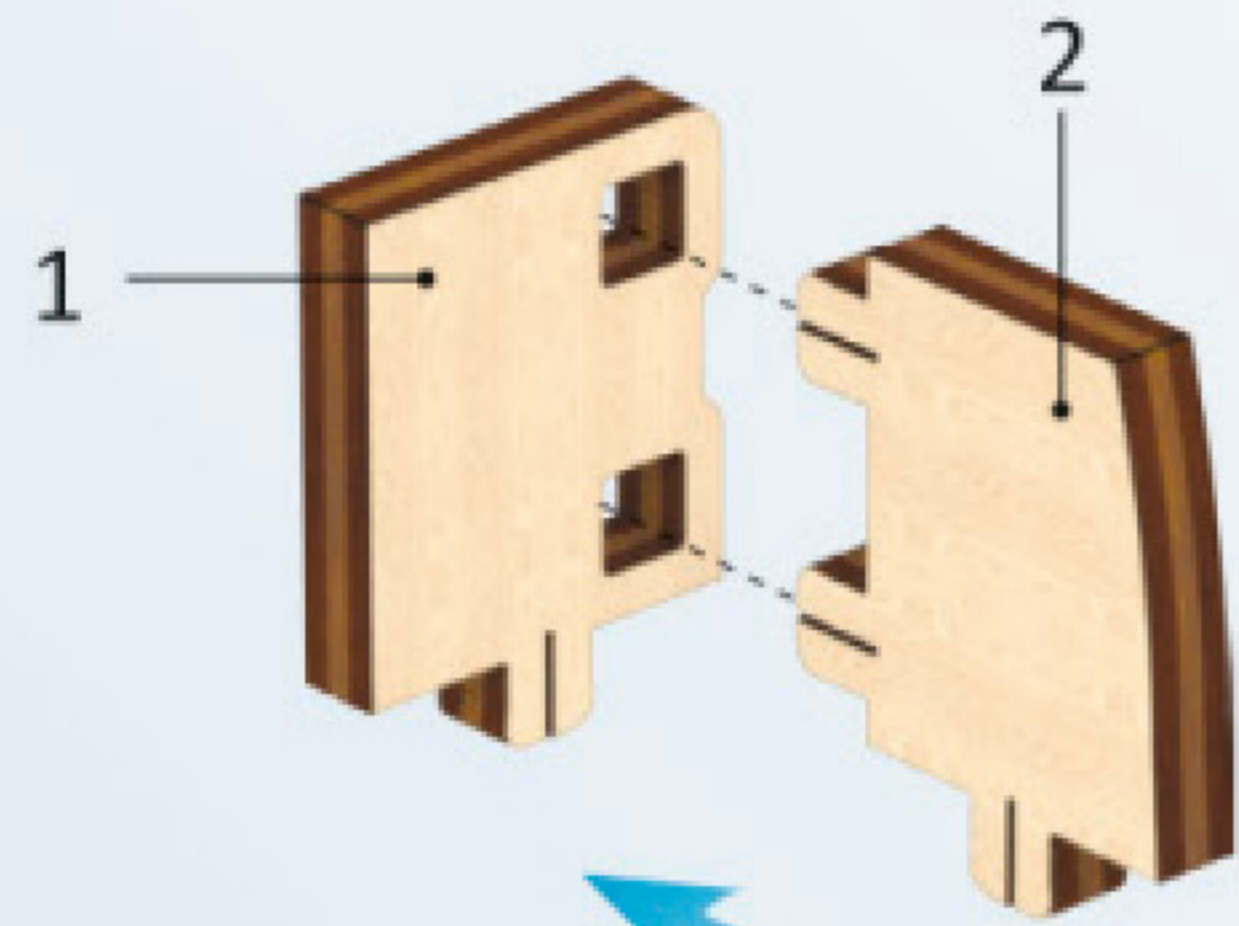

2

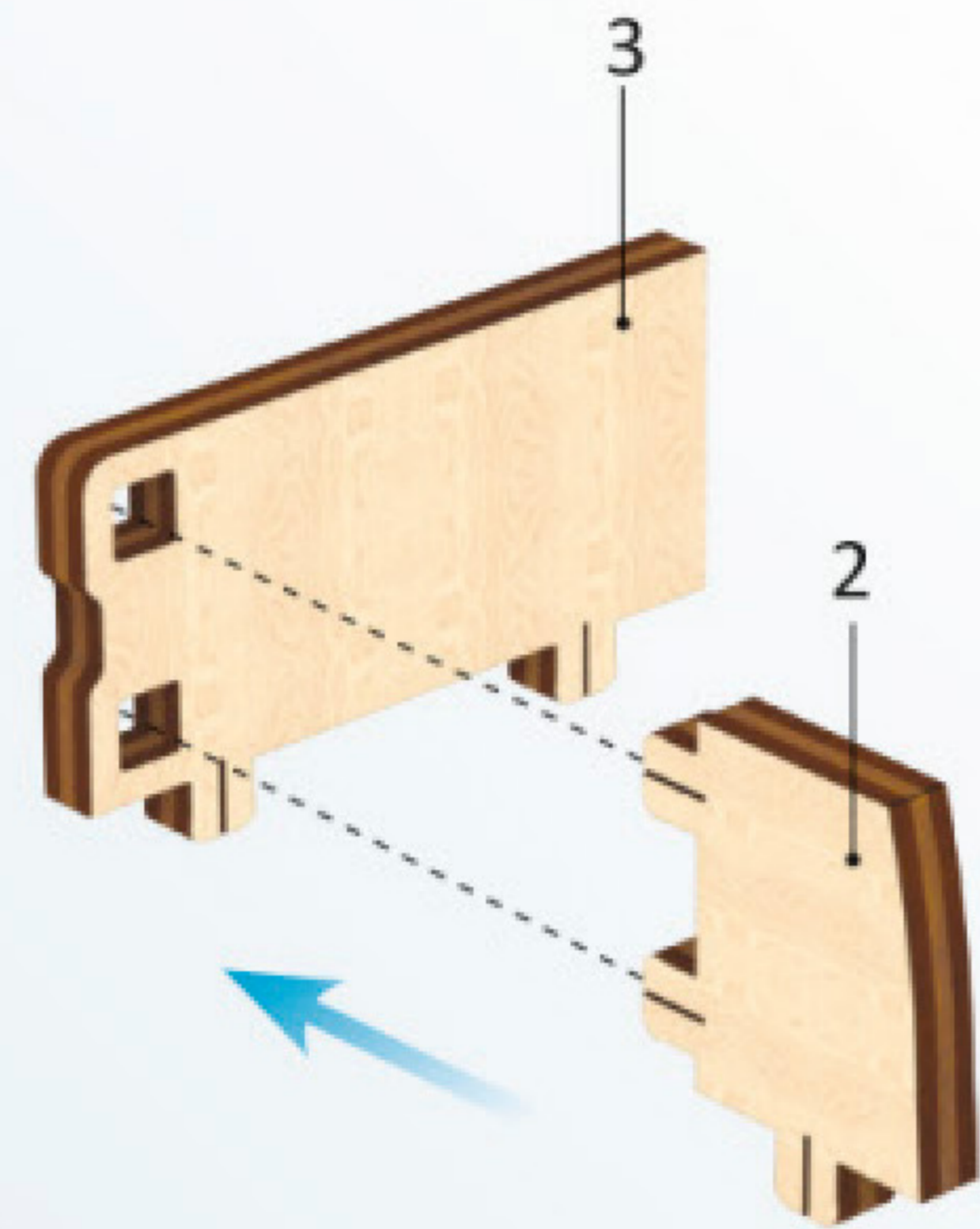

3

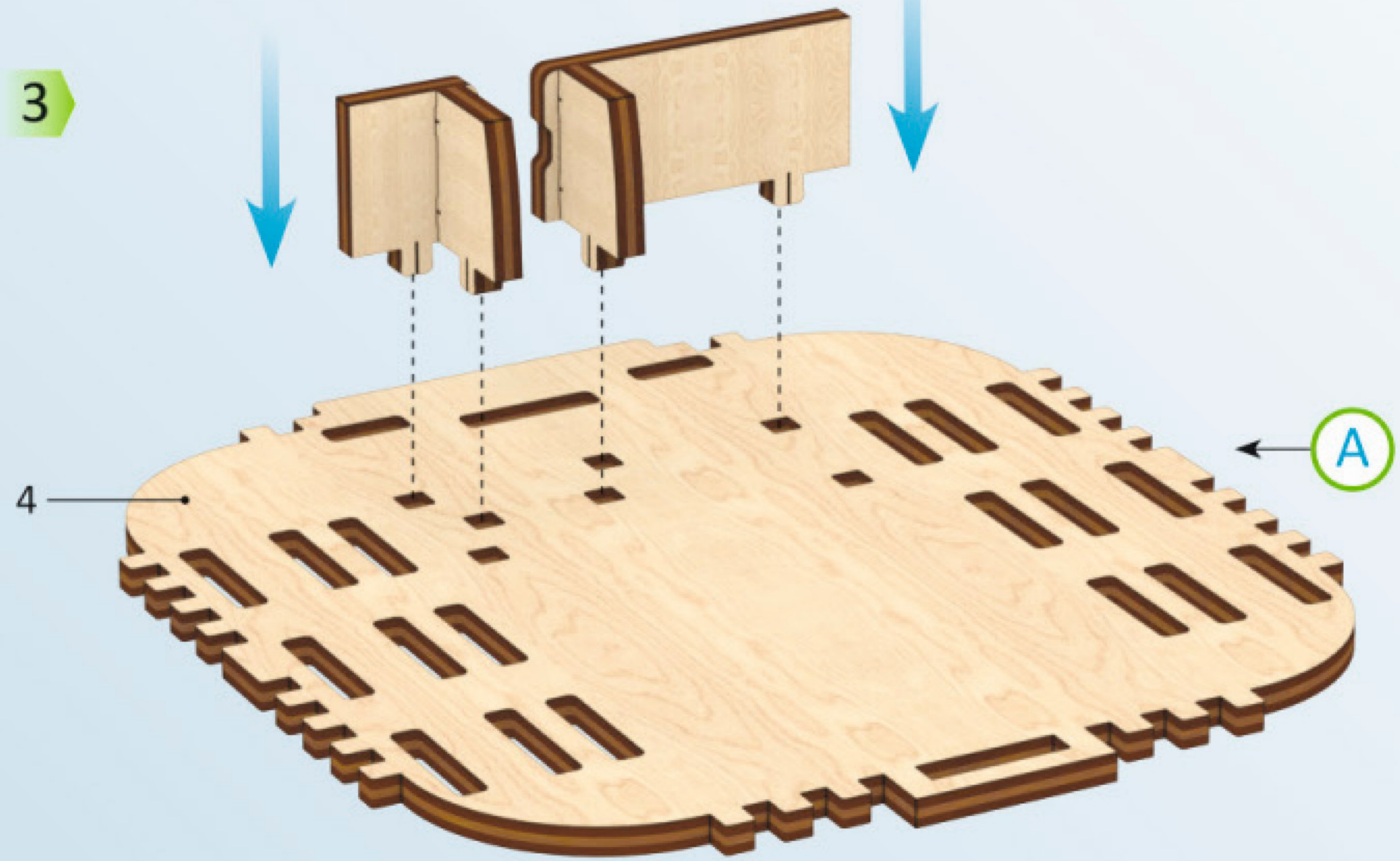

4

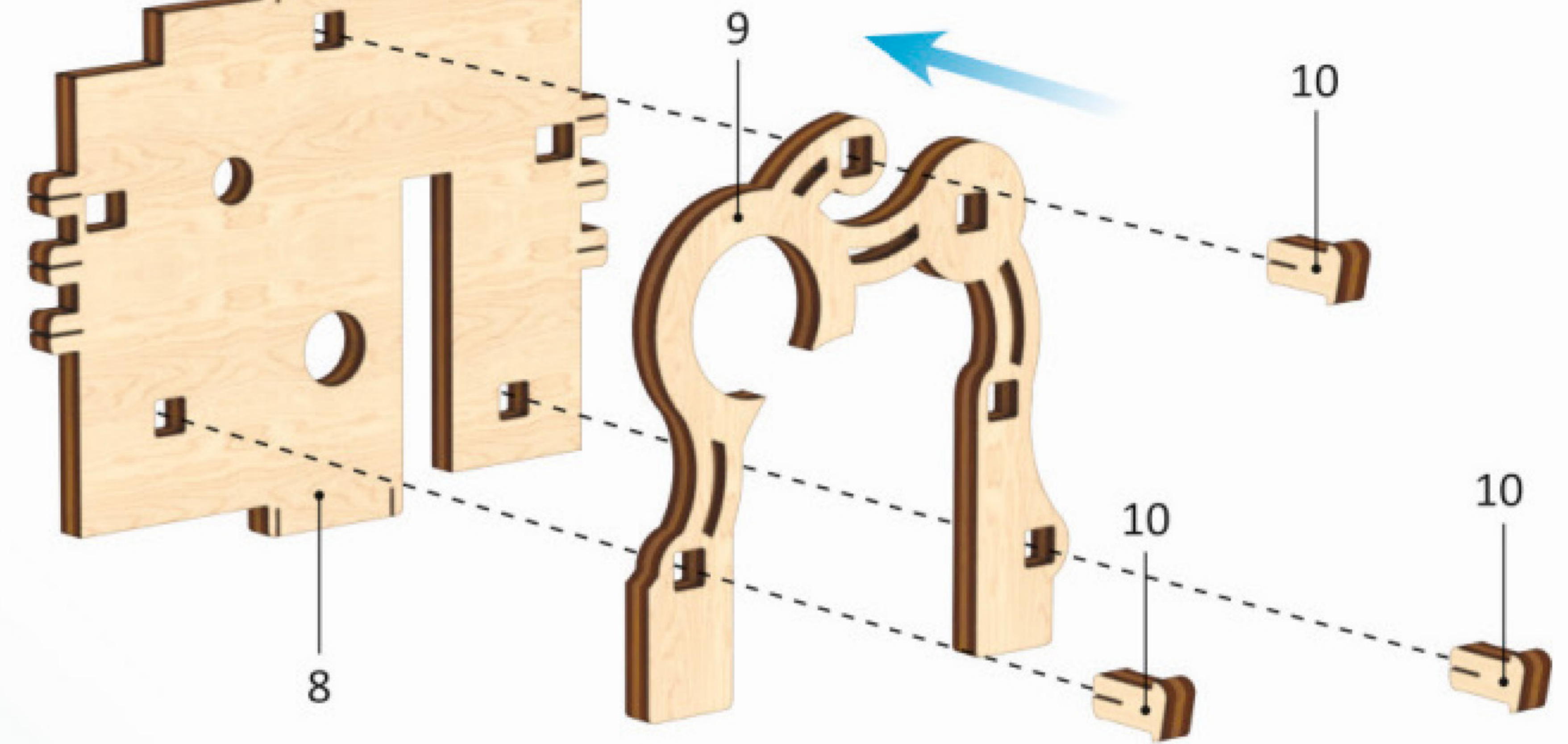

B



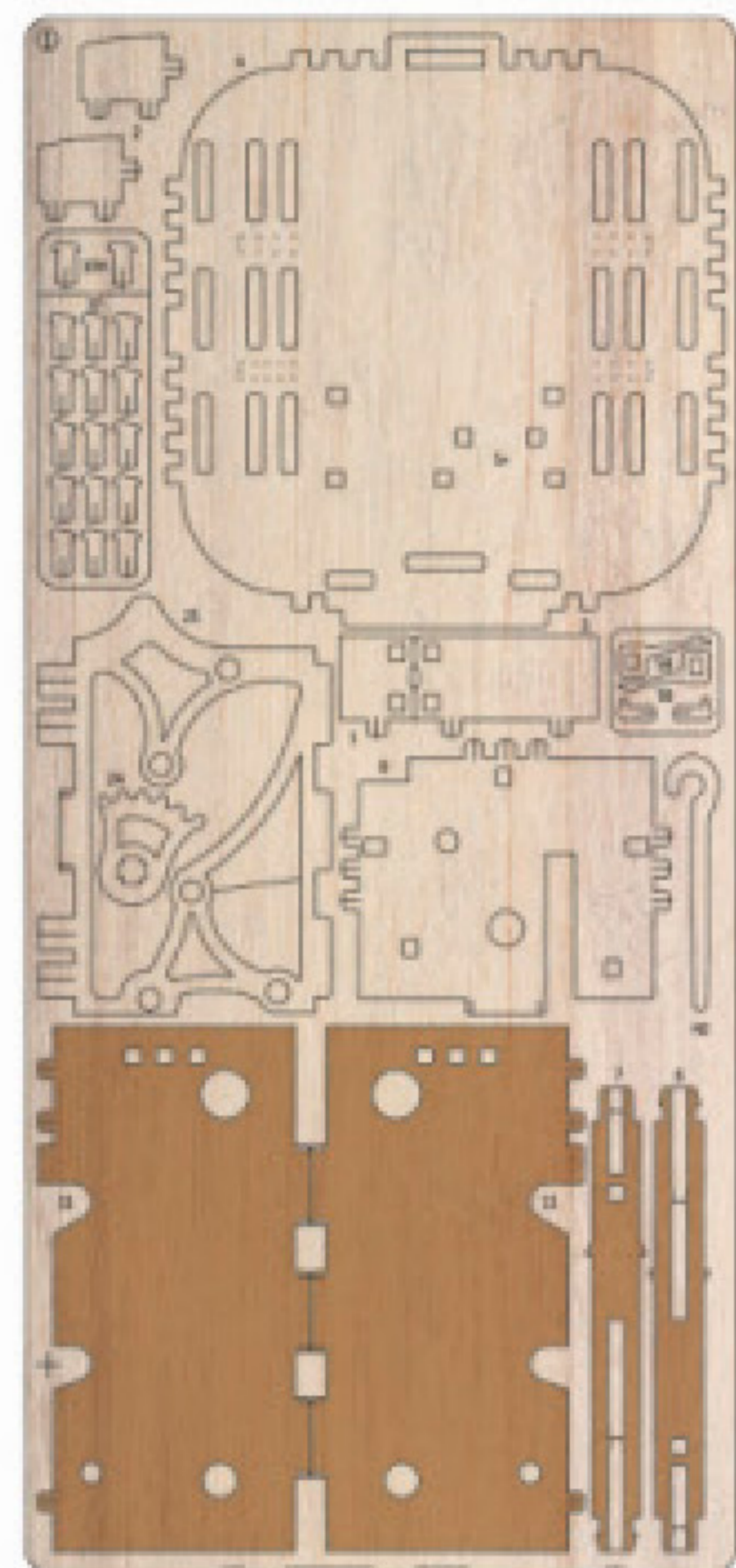

1



4

1

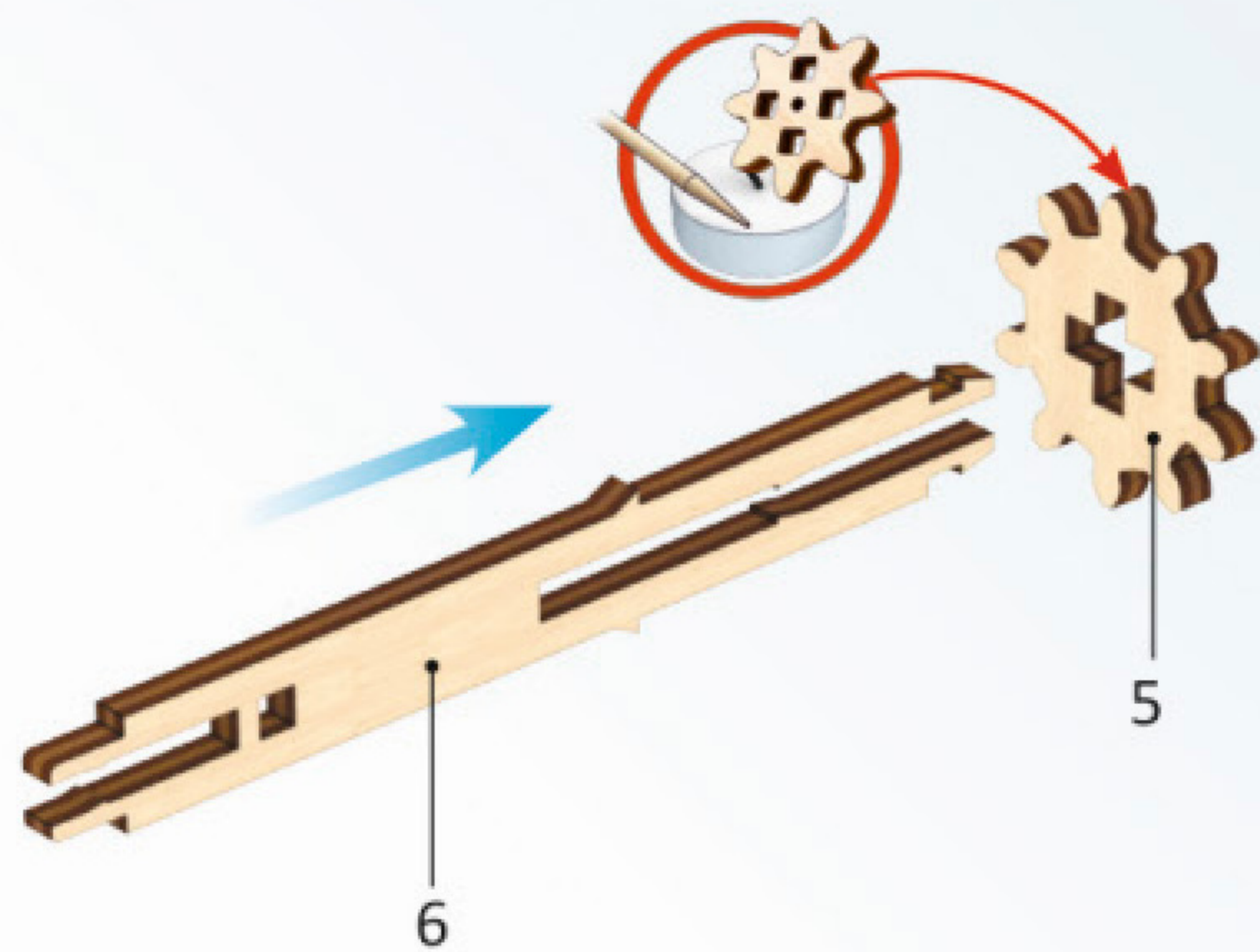

2

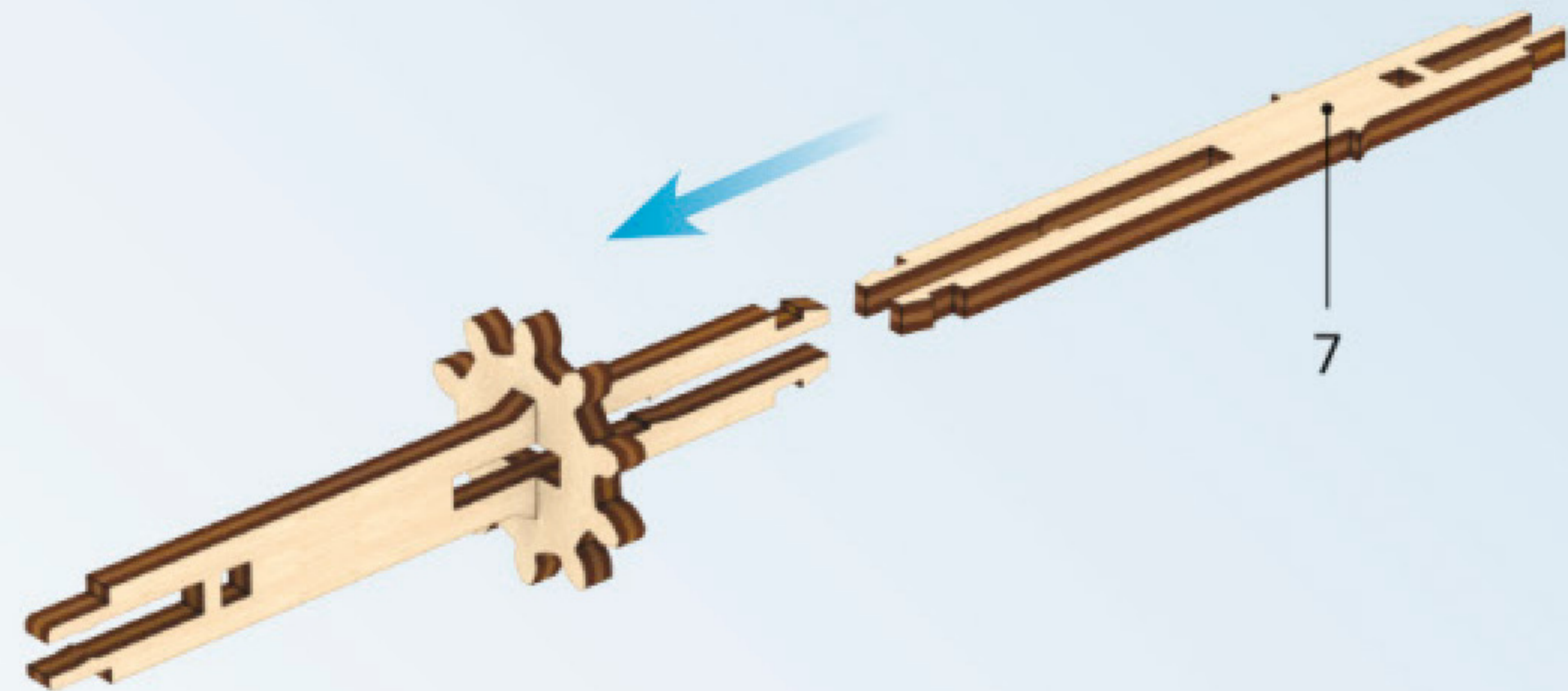

C

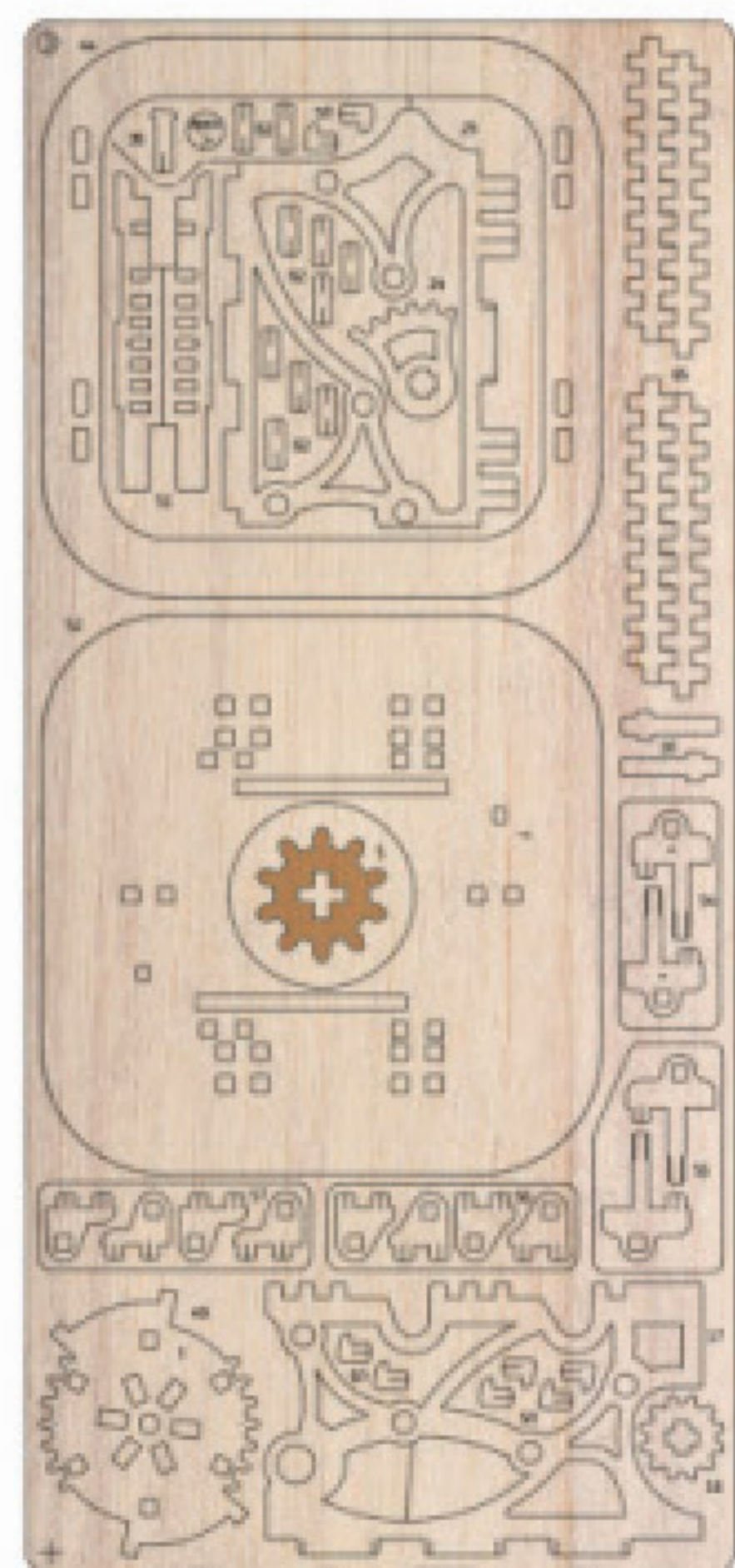
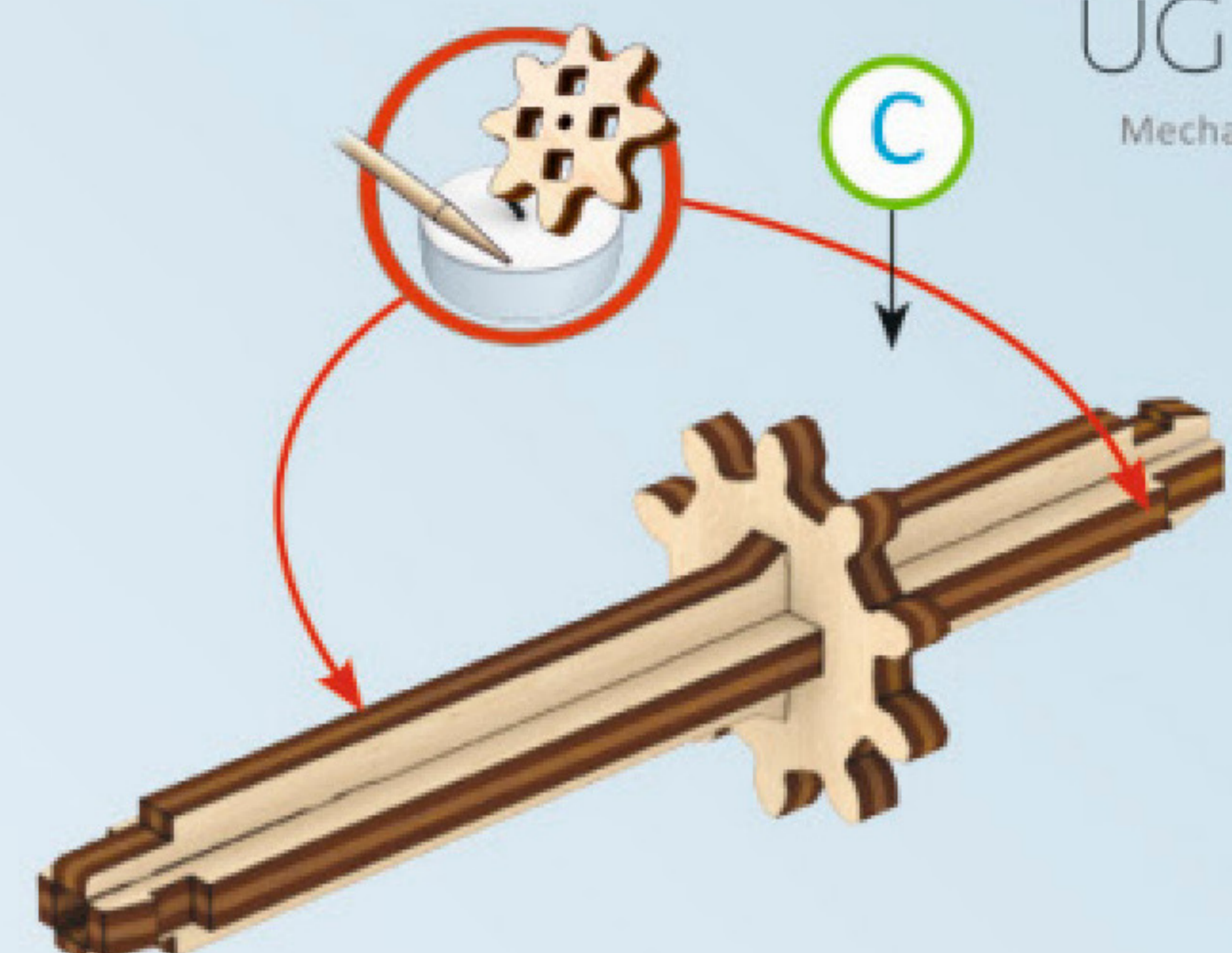

3

3

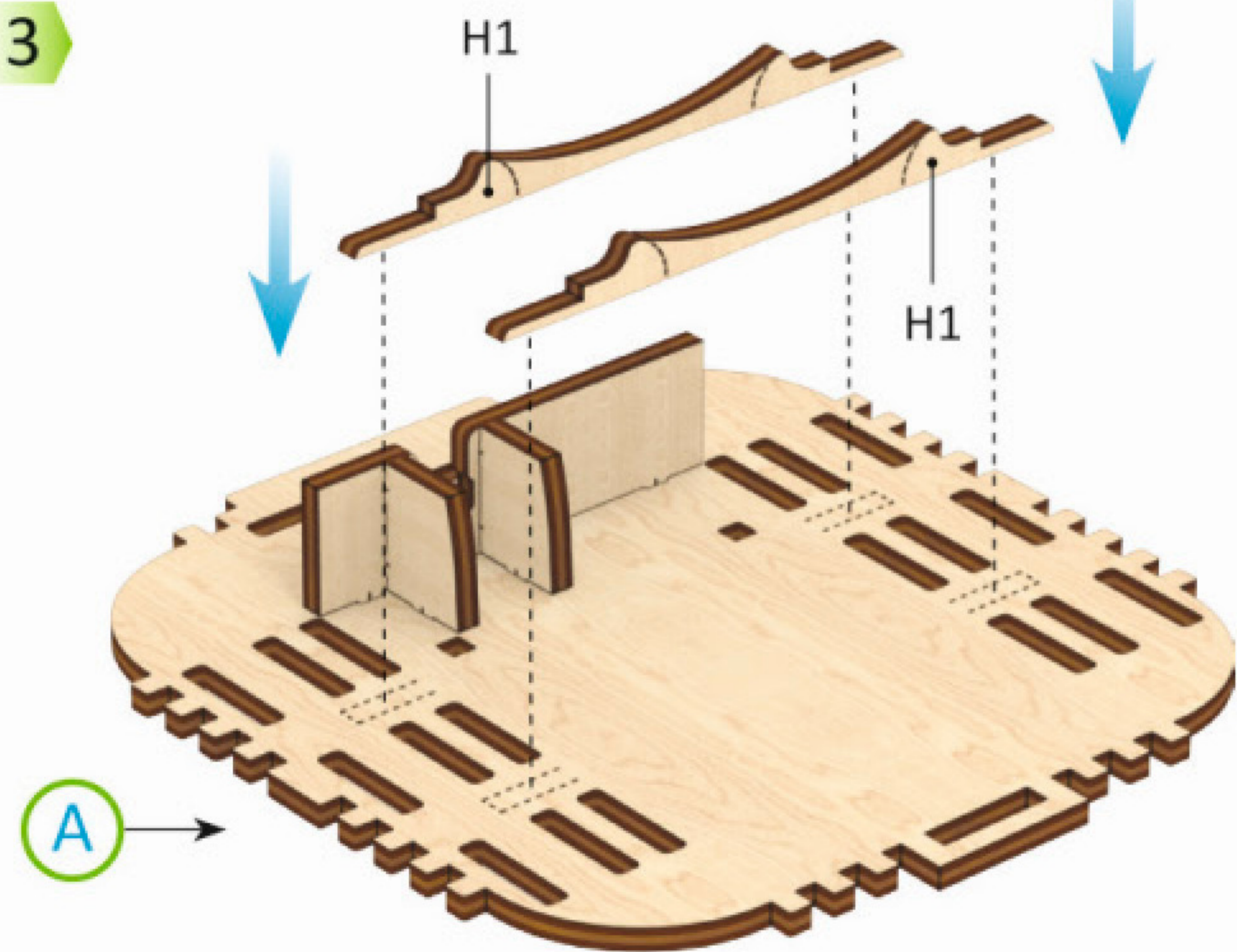

4

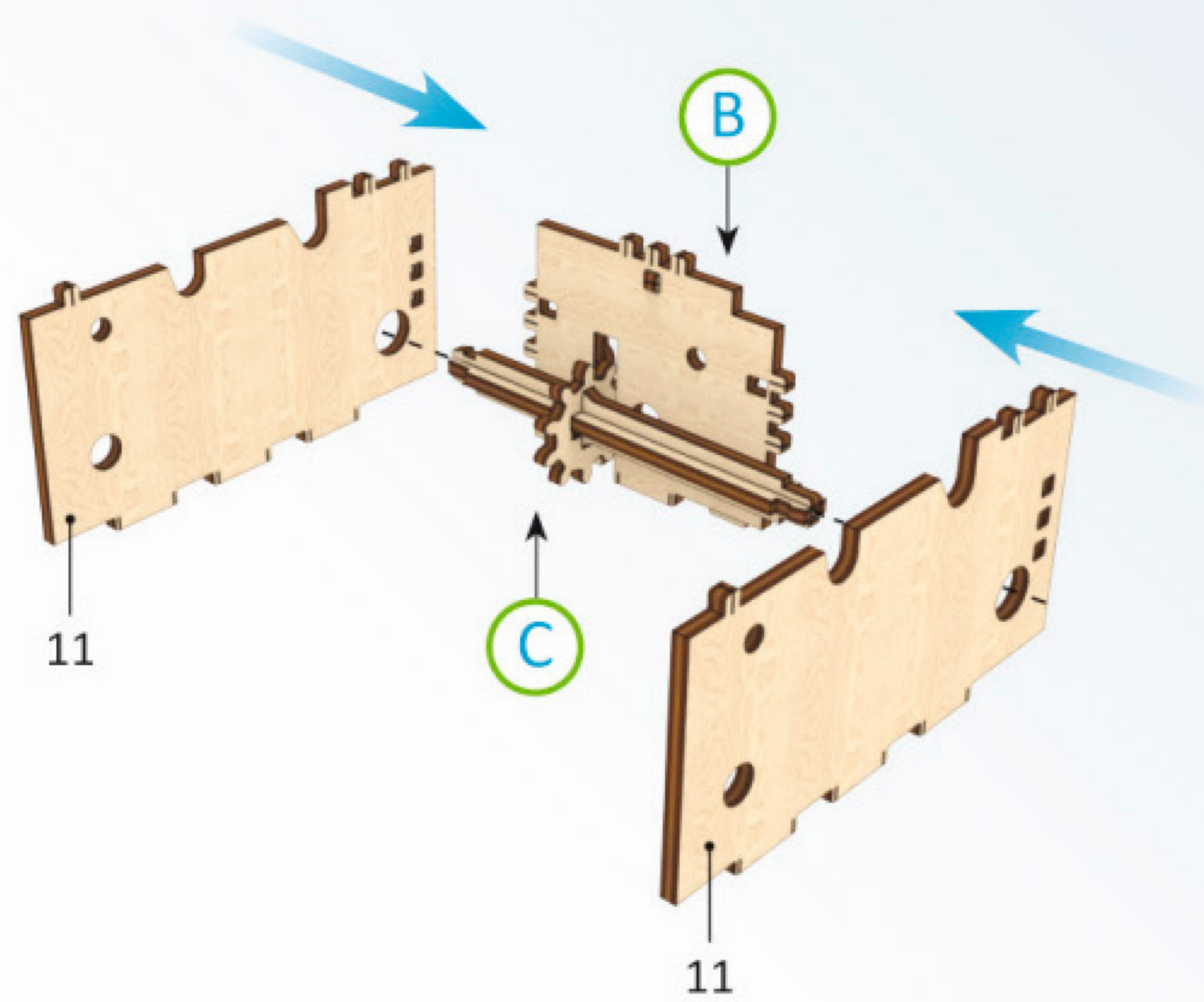

5

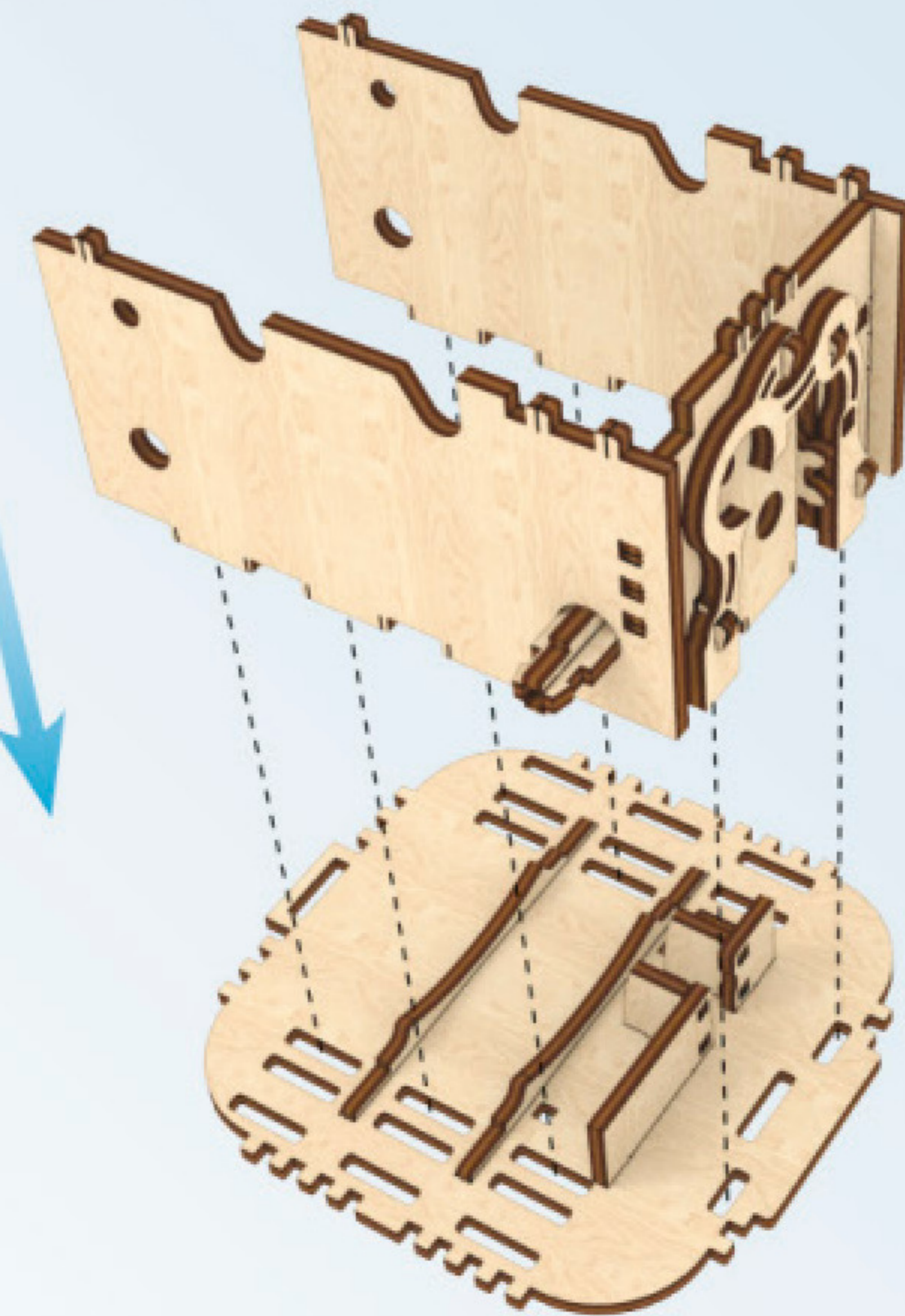

5

Mechanical models

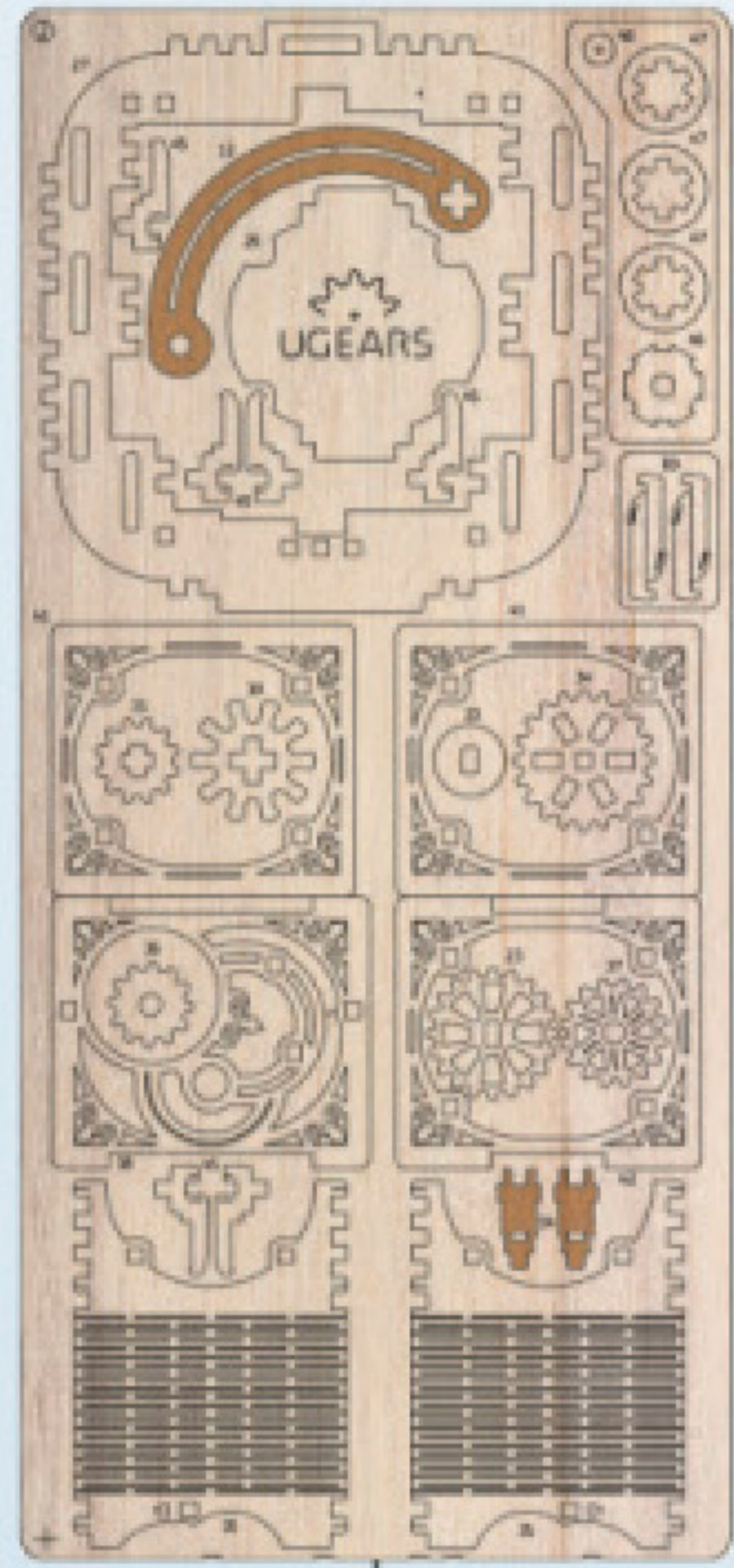

1

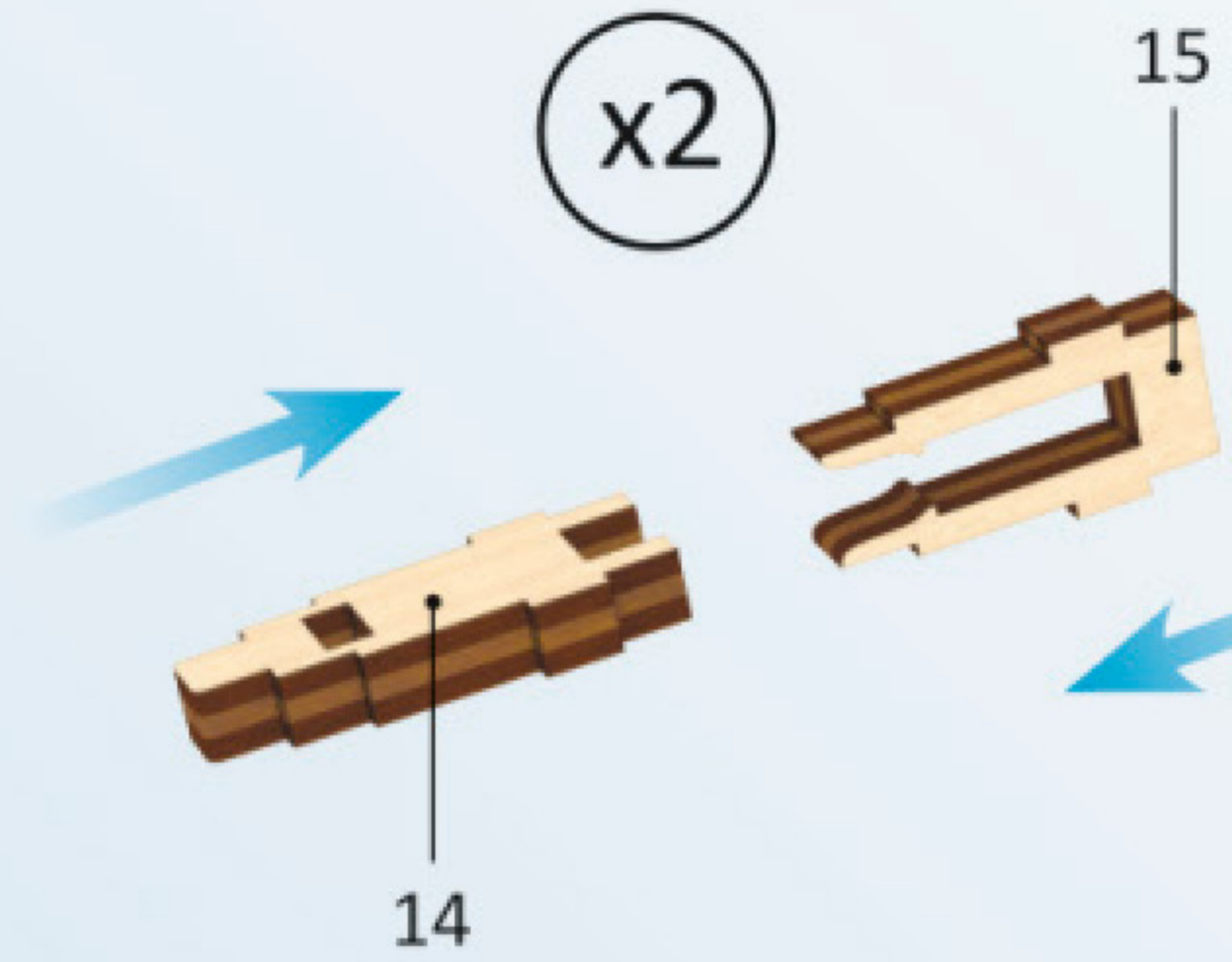

2

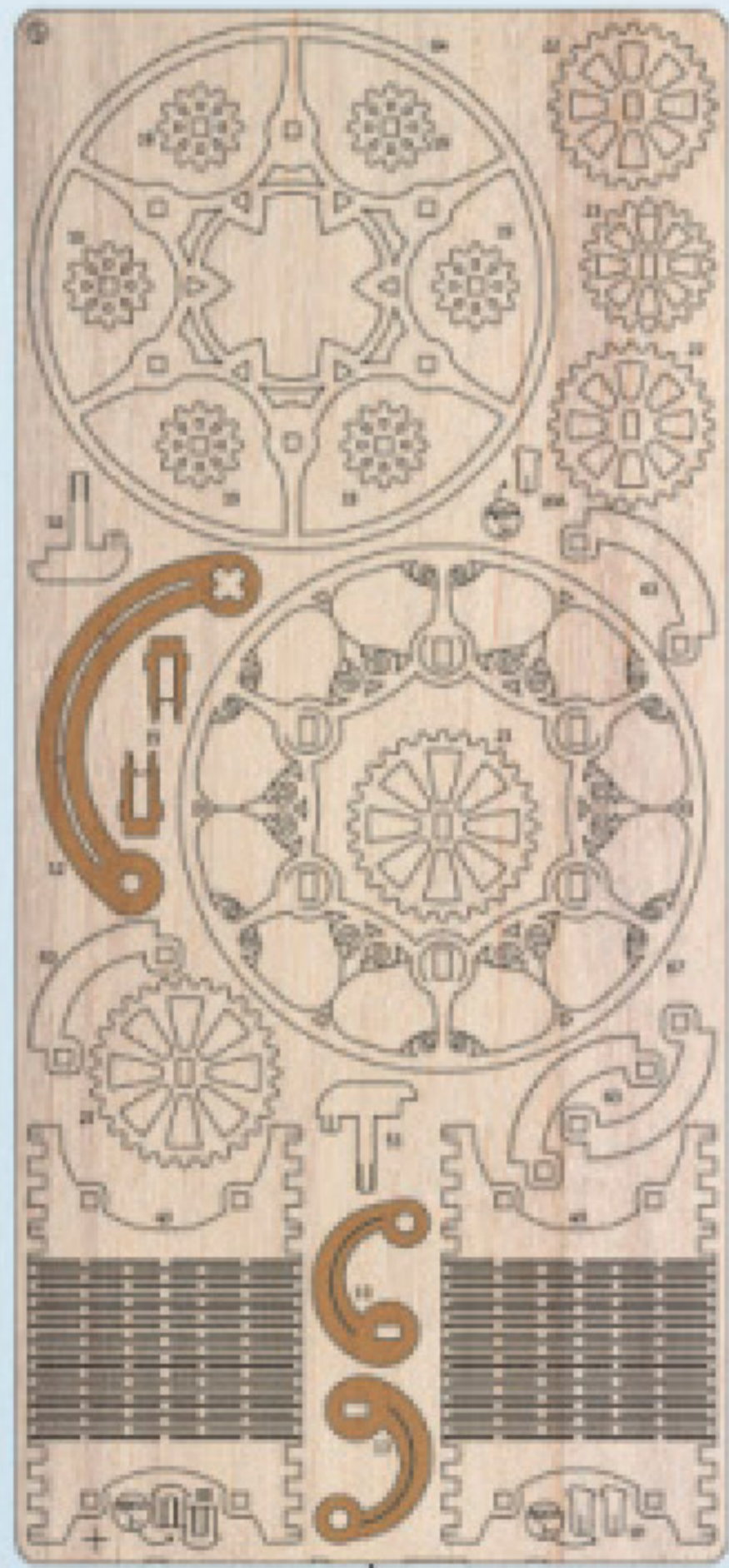
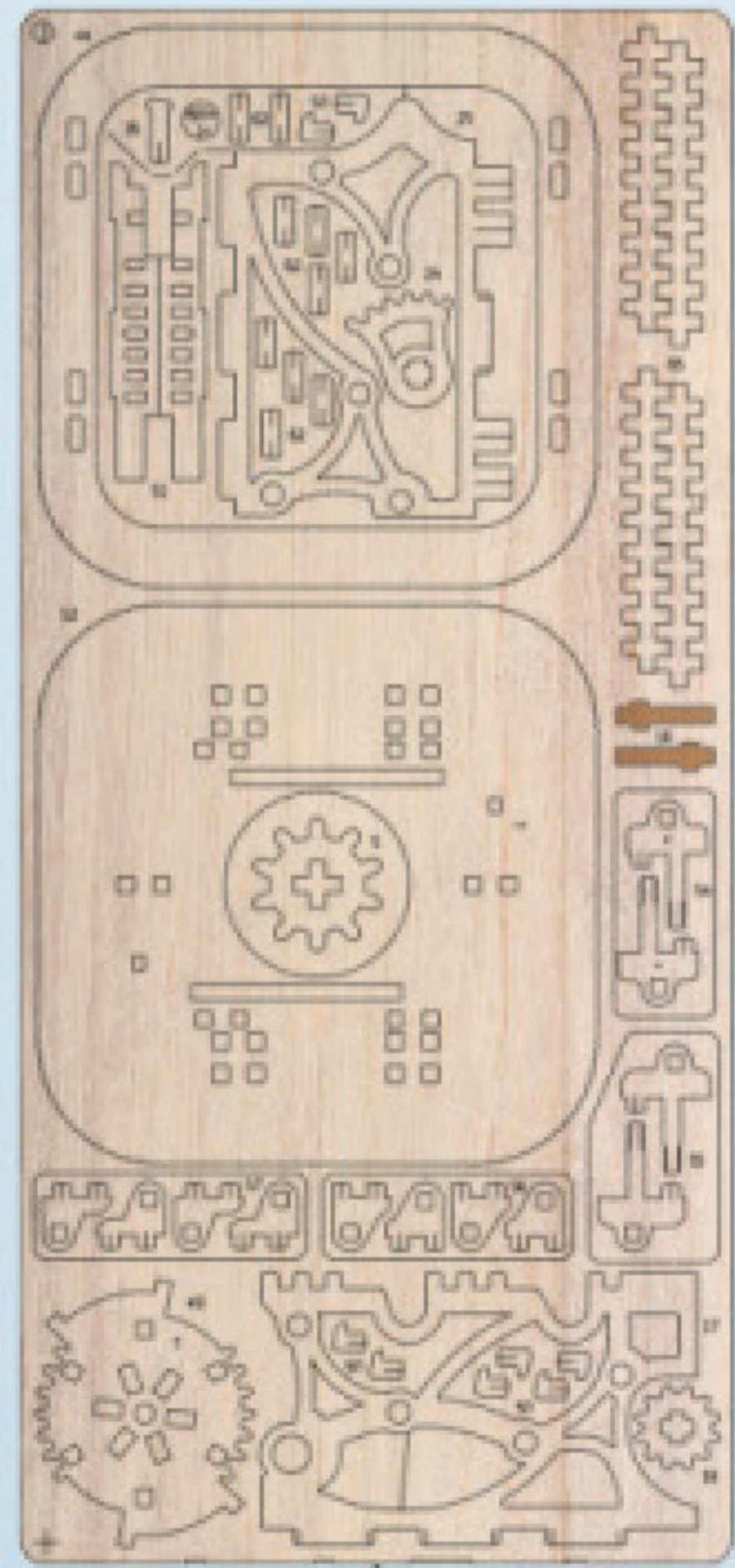
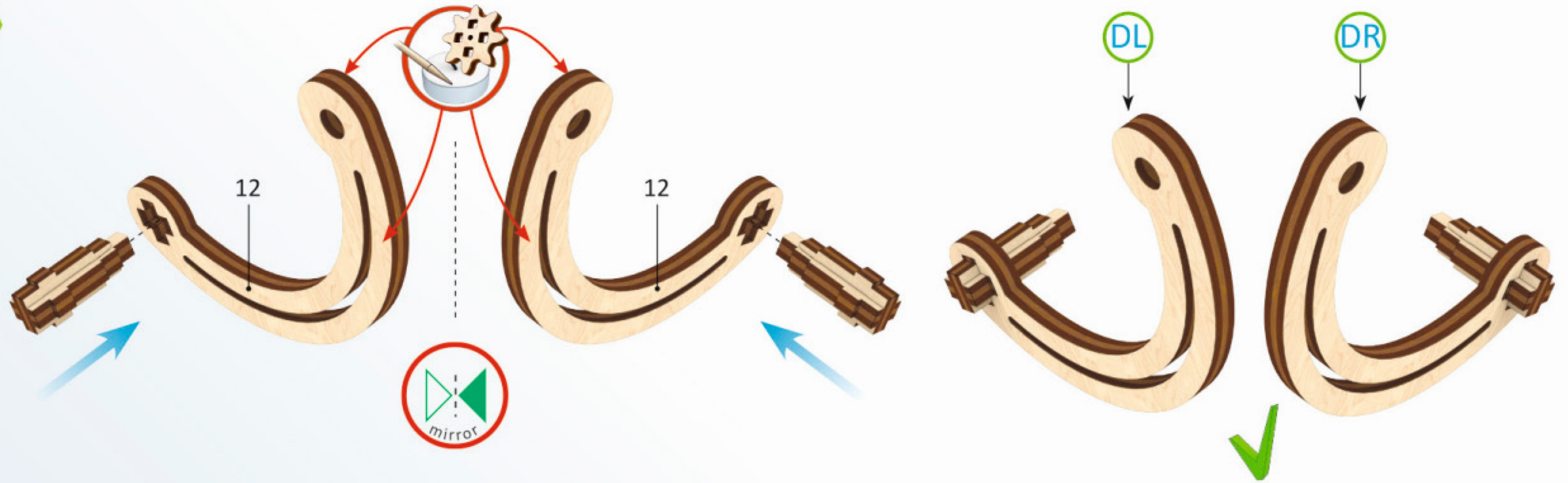

3

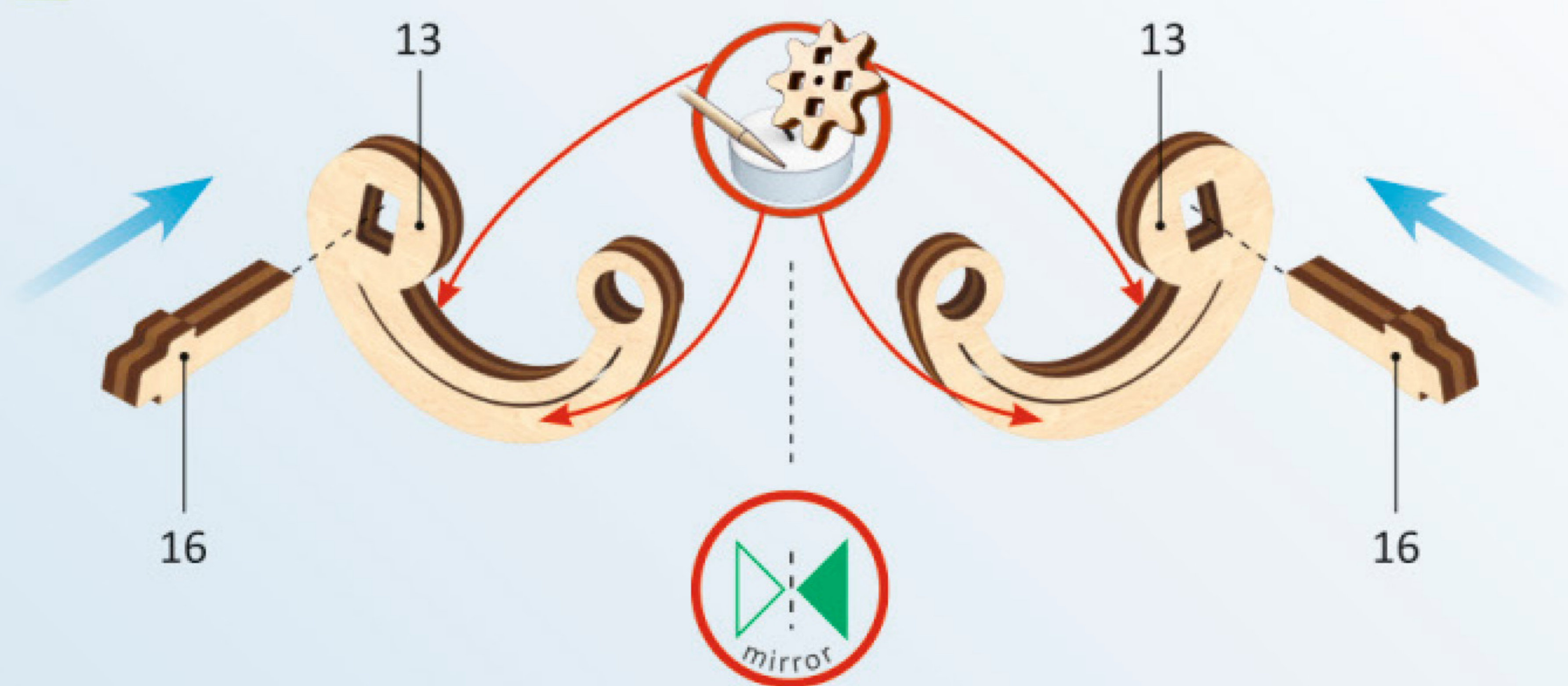

6

3

5

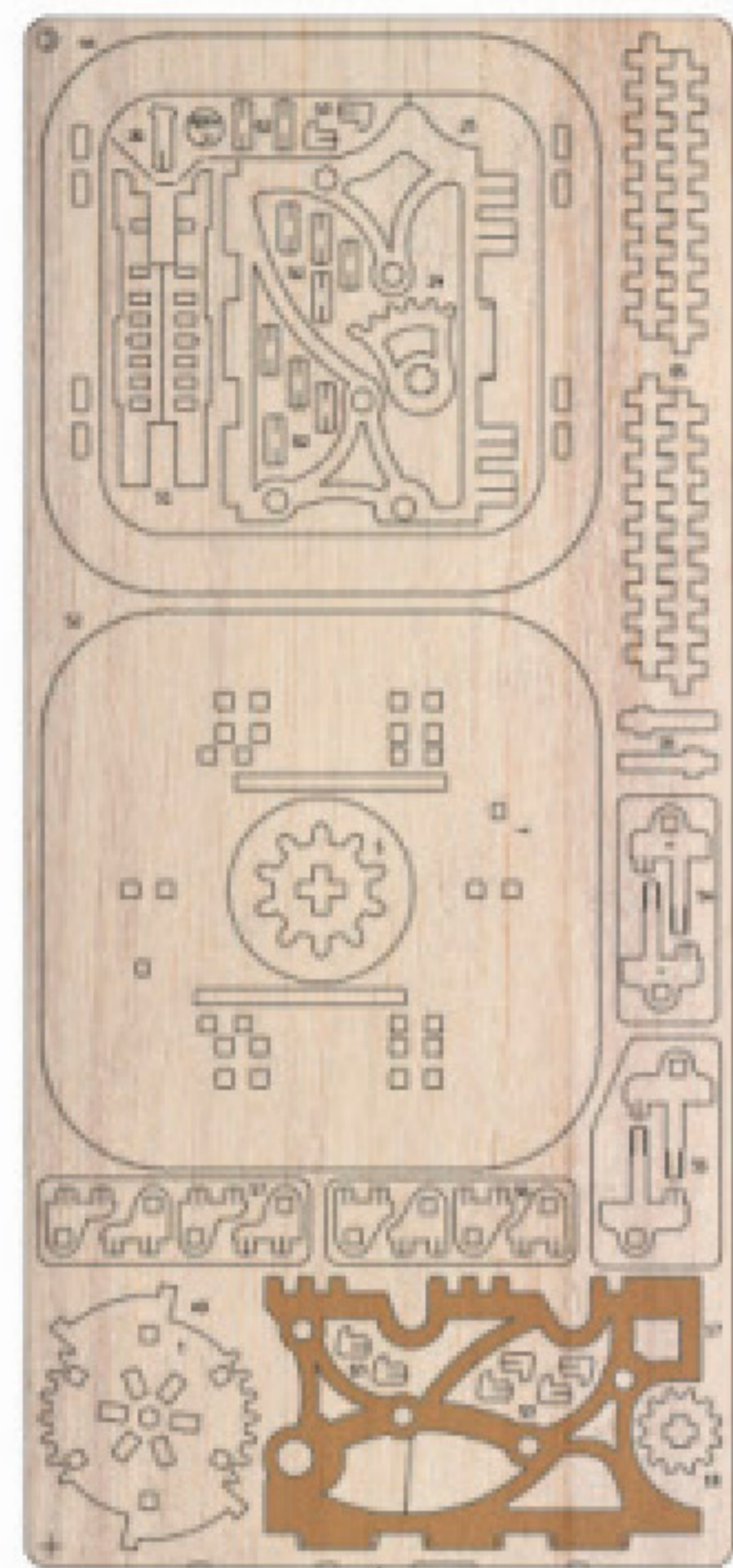

1

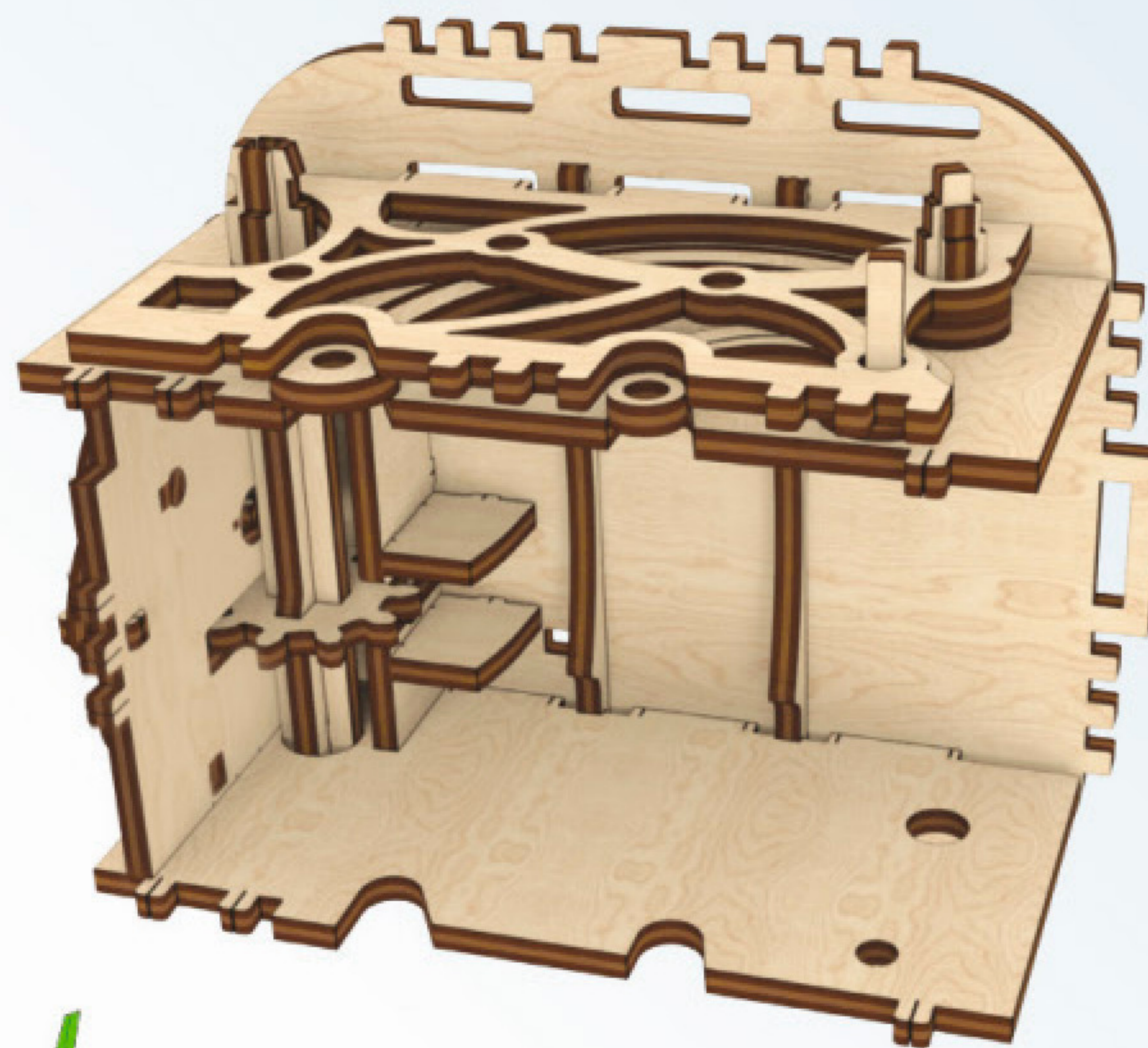
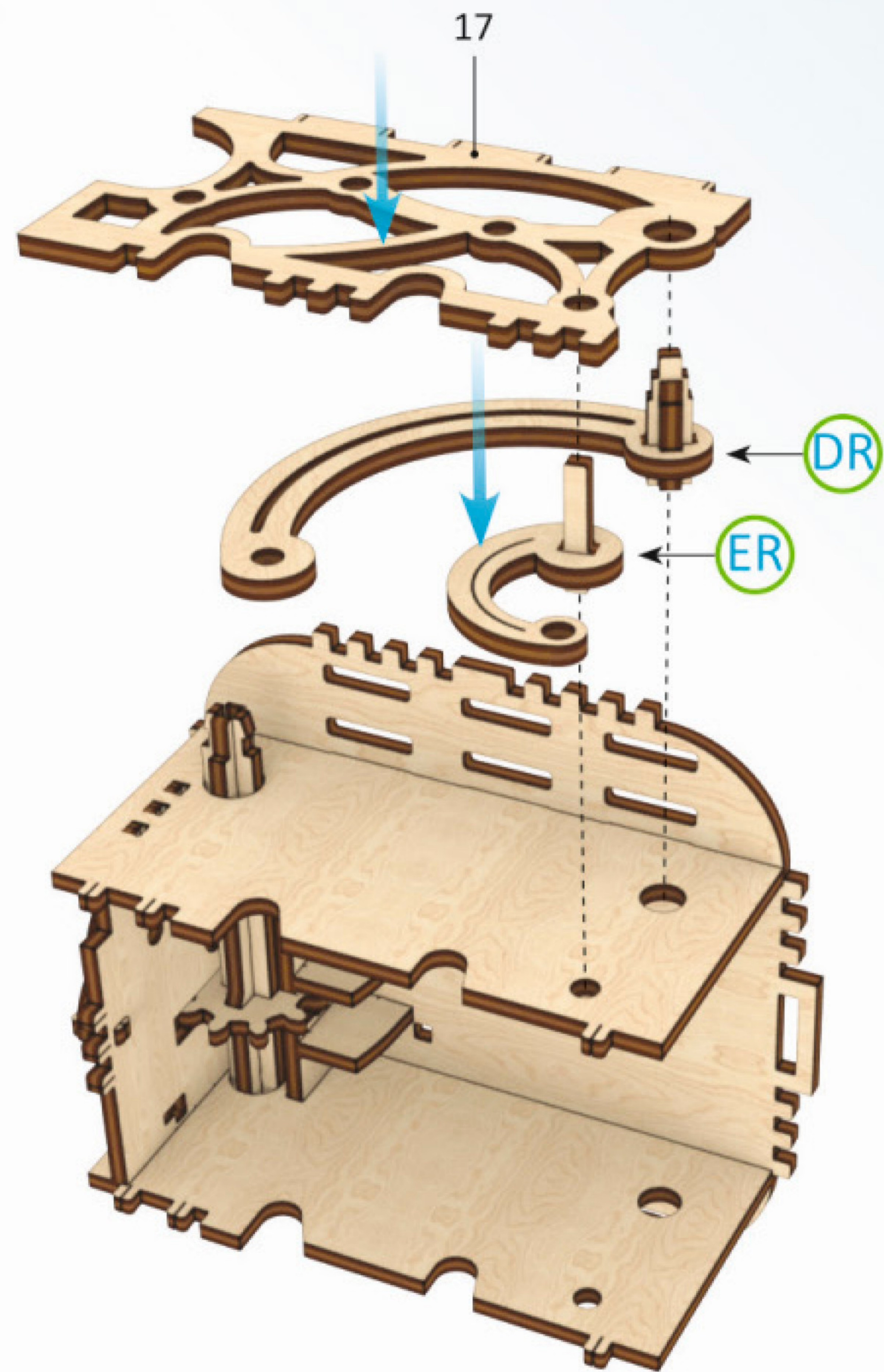

2

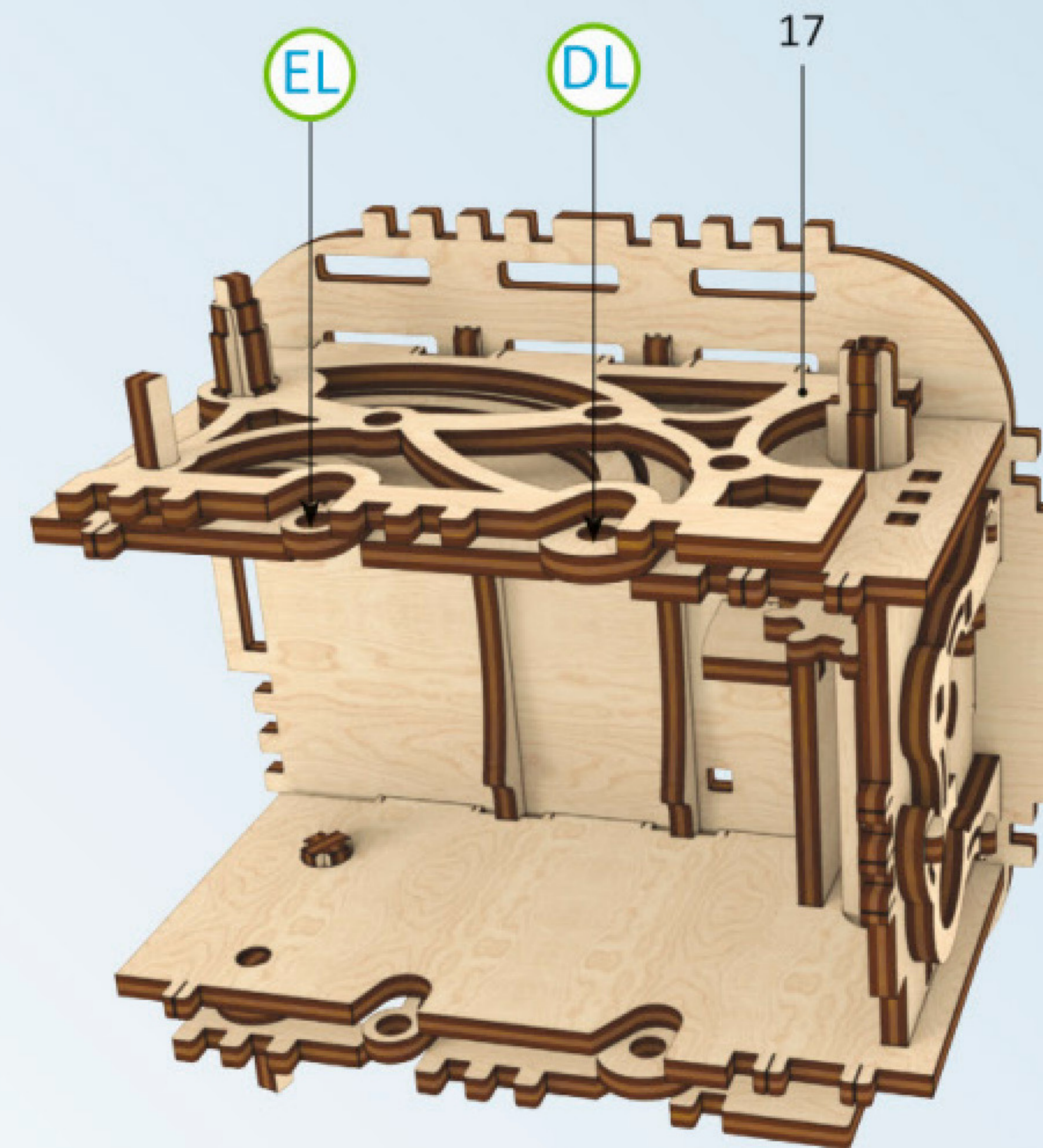

Mechanical models

1

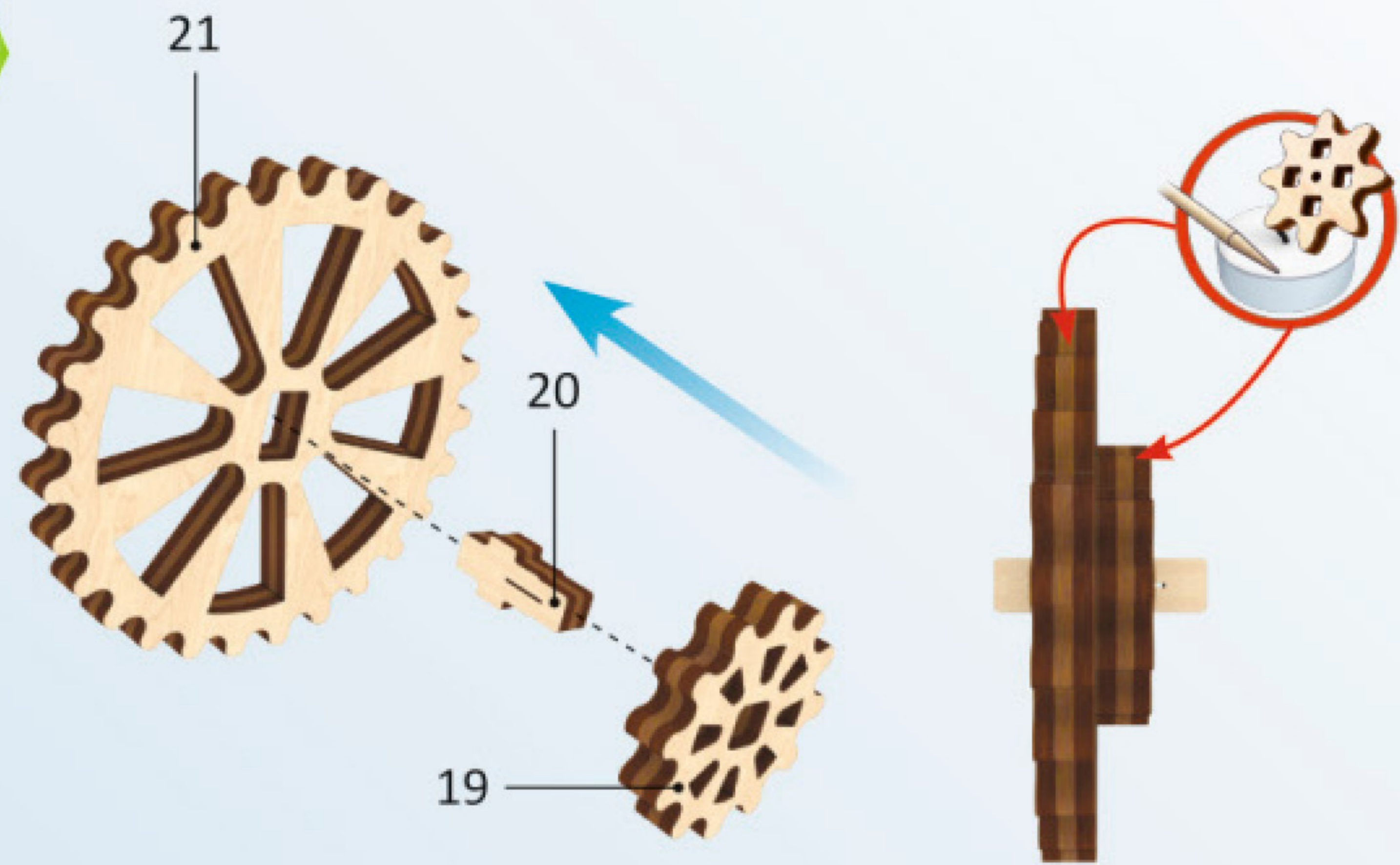

F

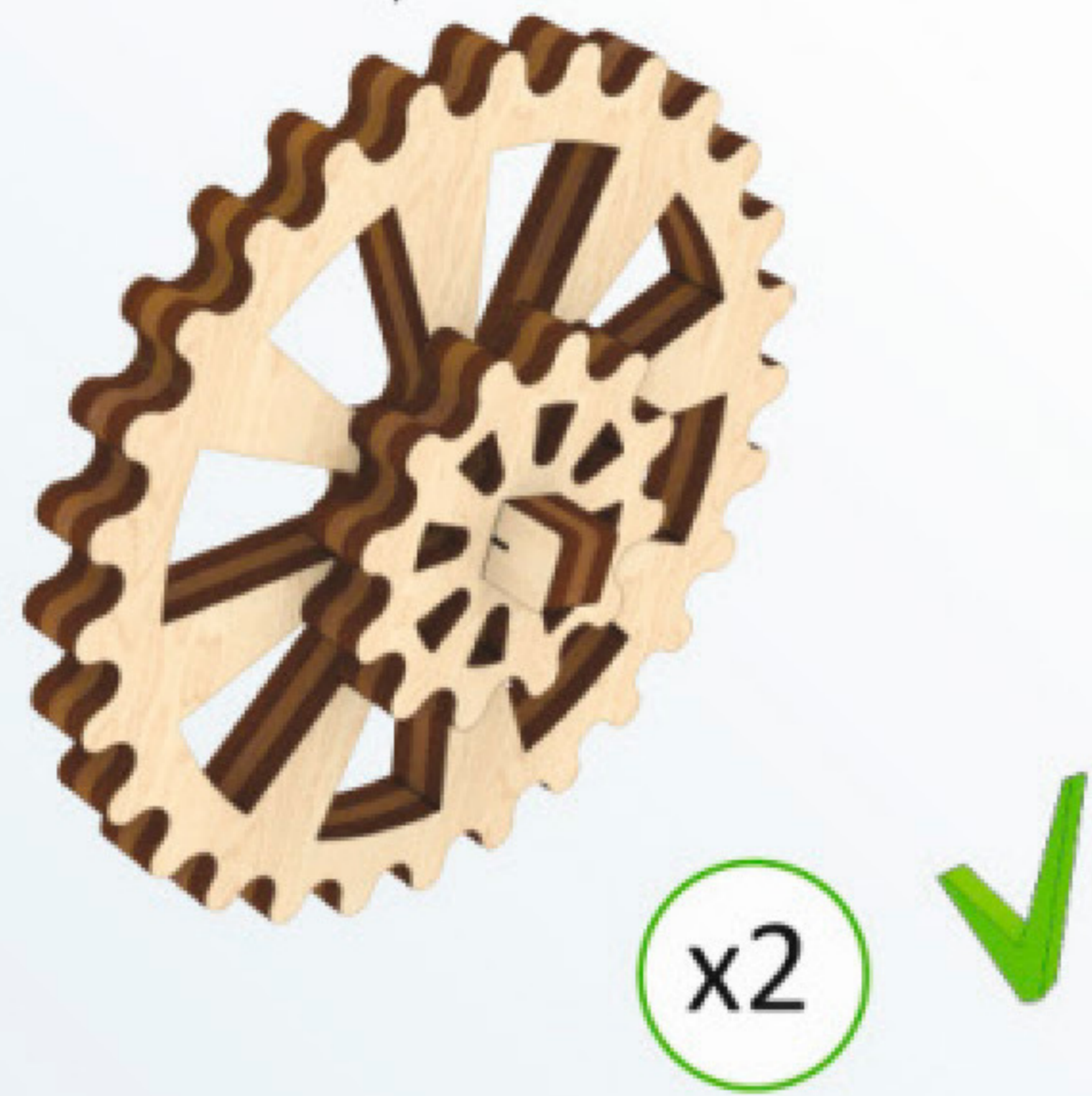

2

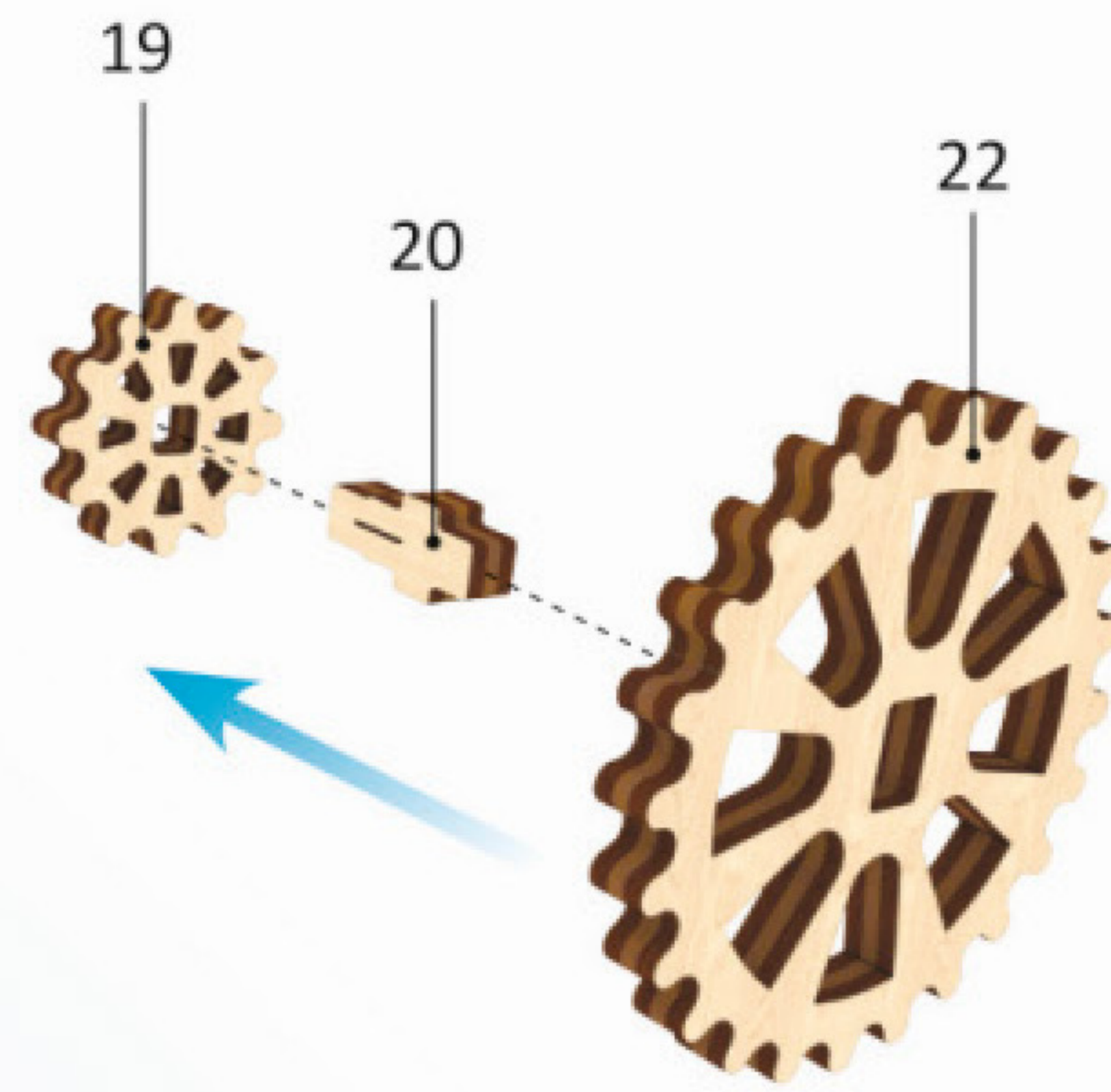

G

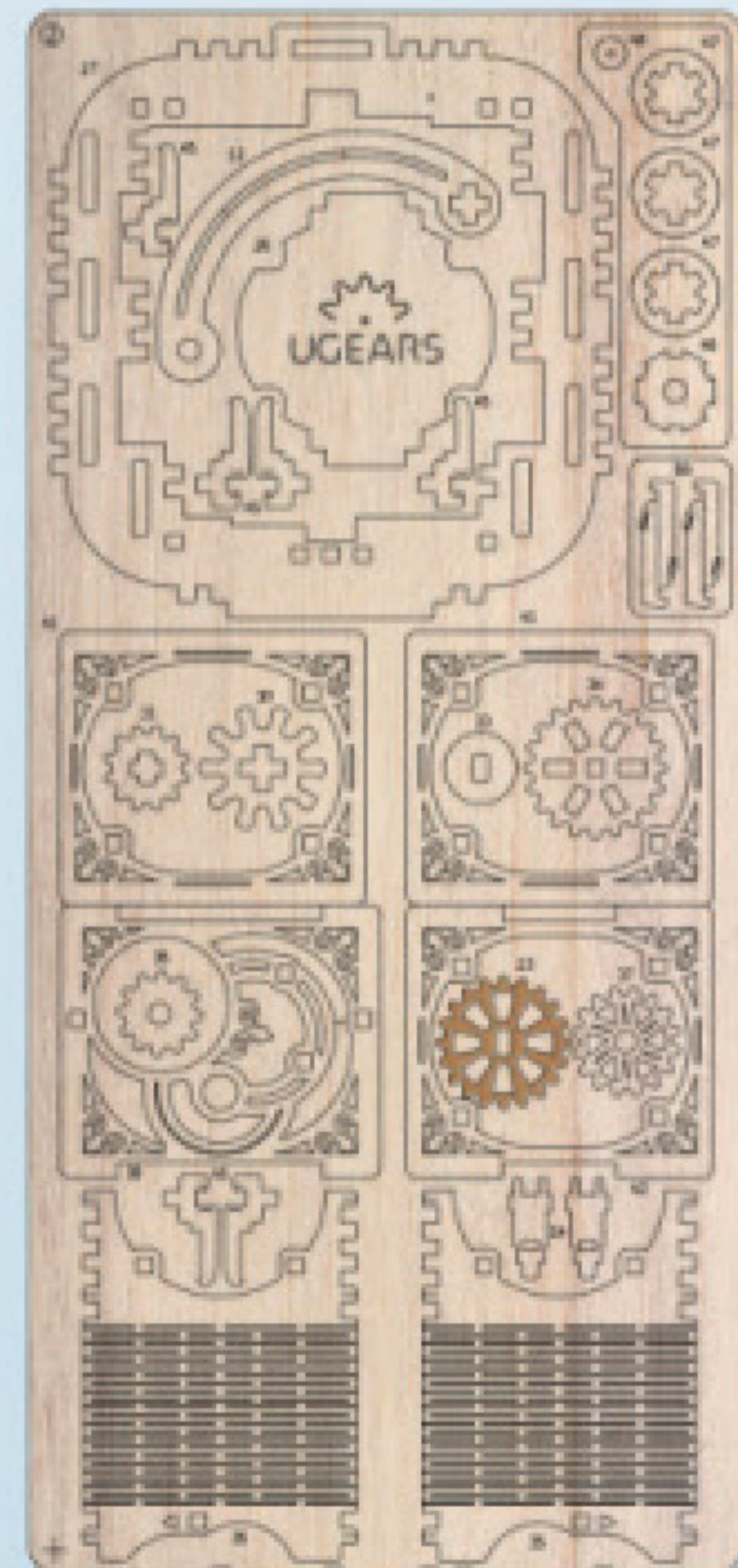
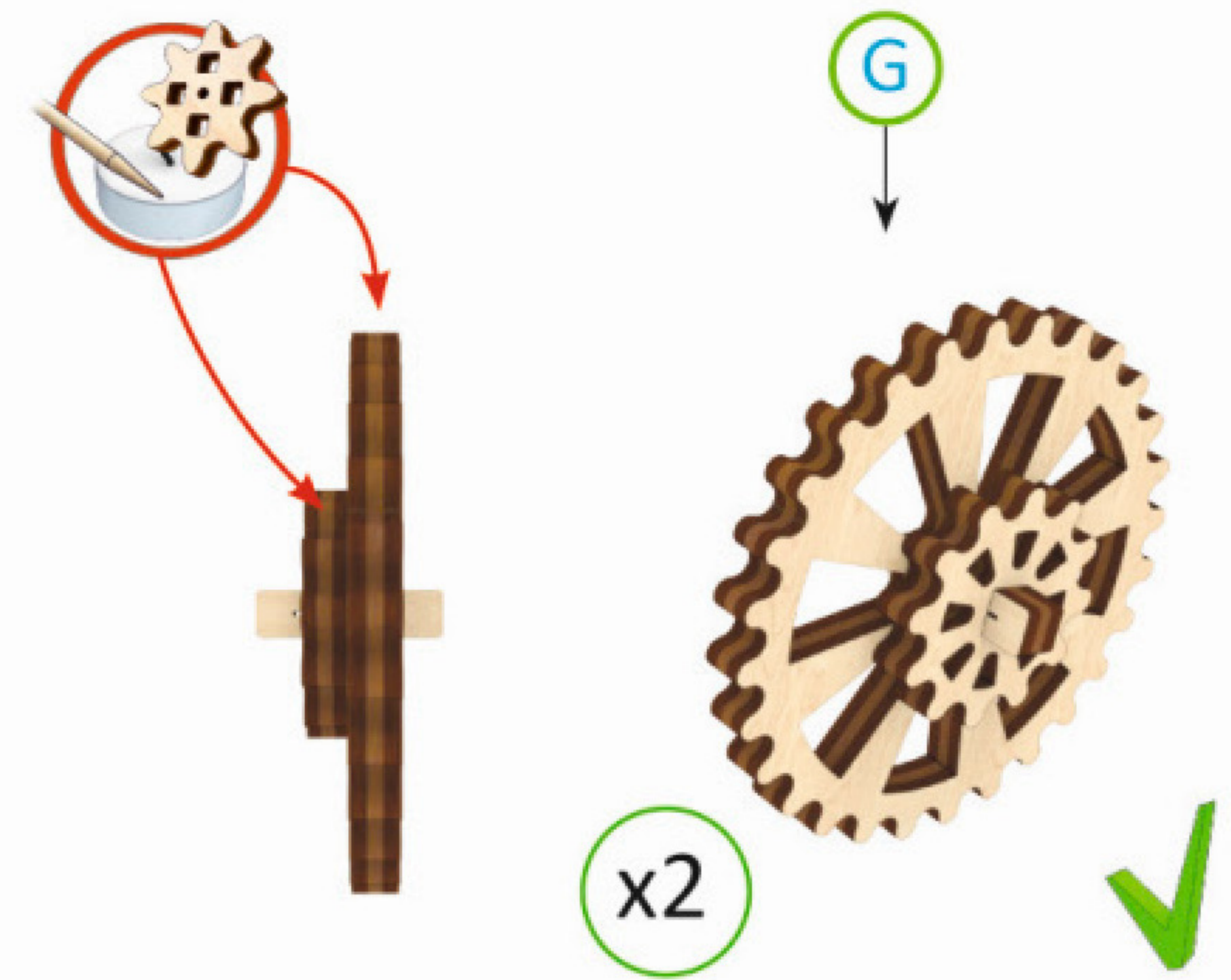

2

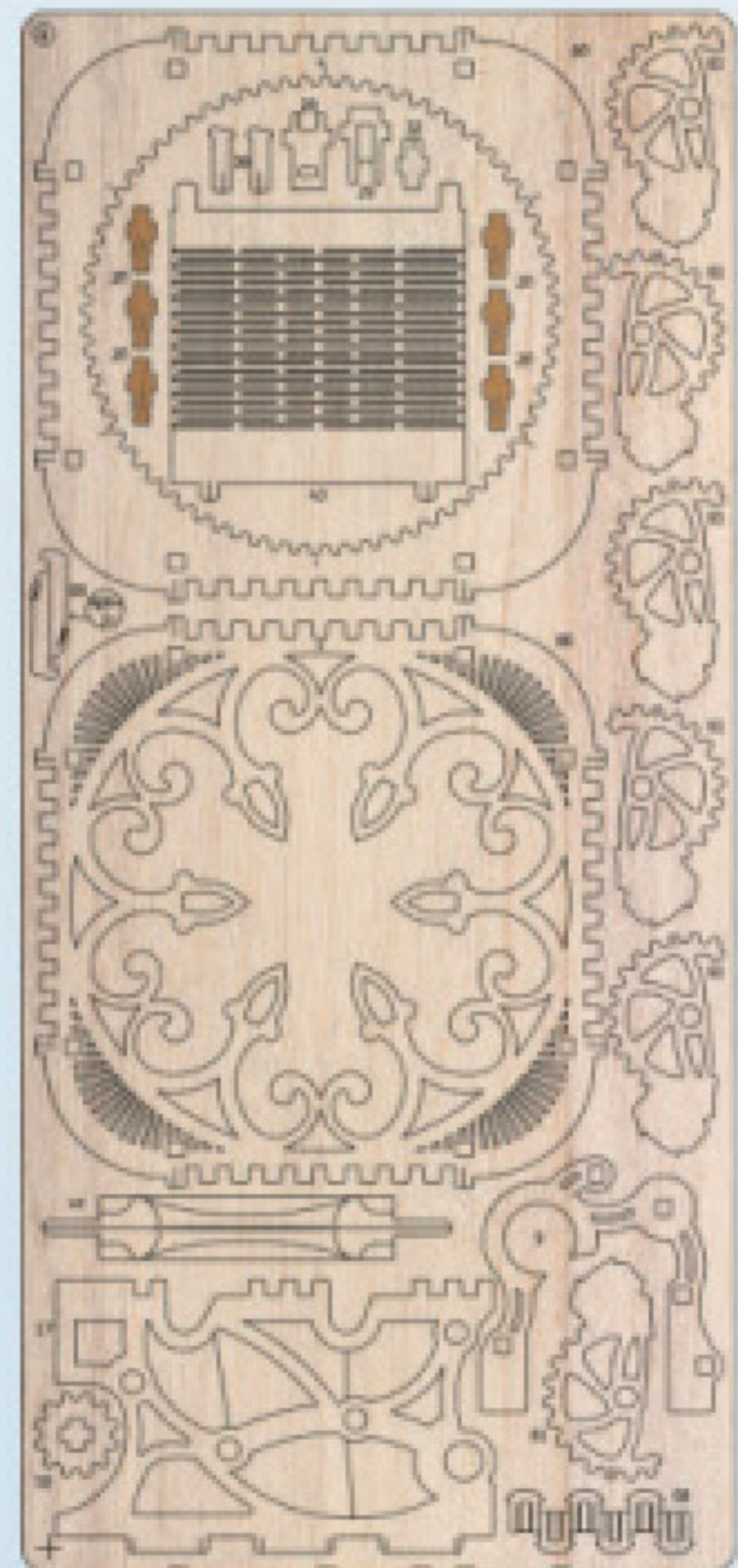

4

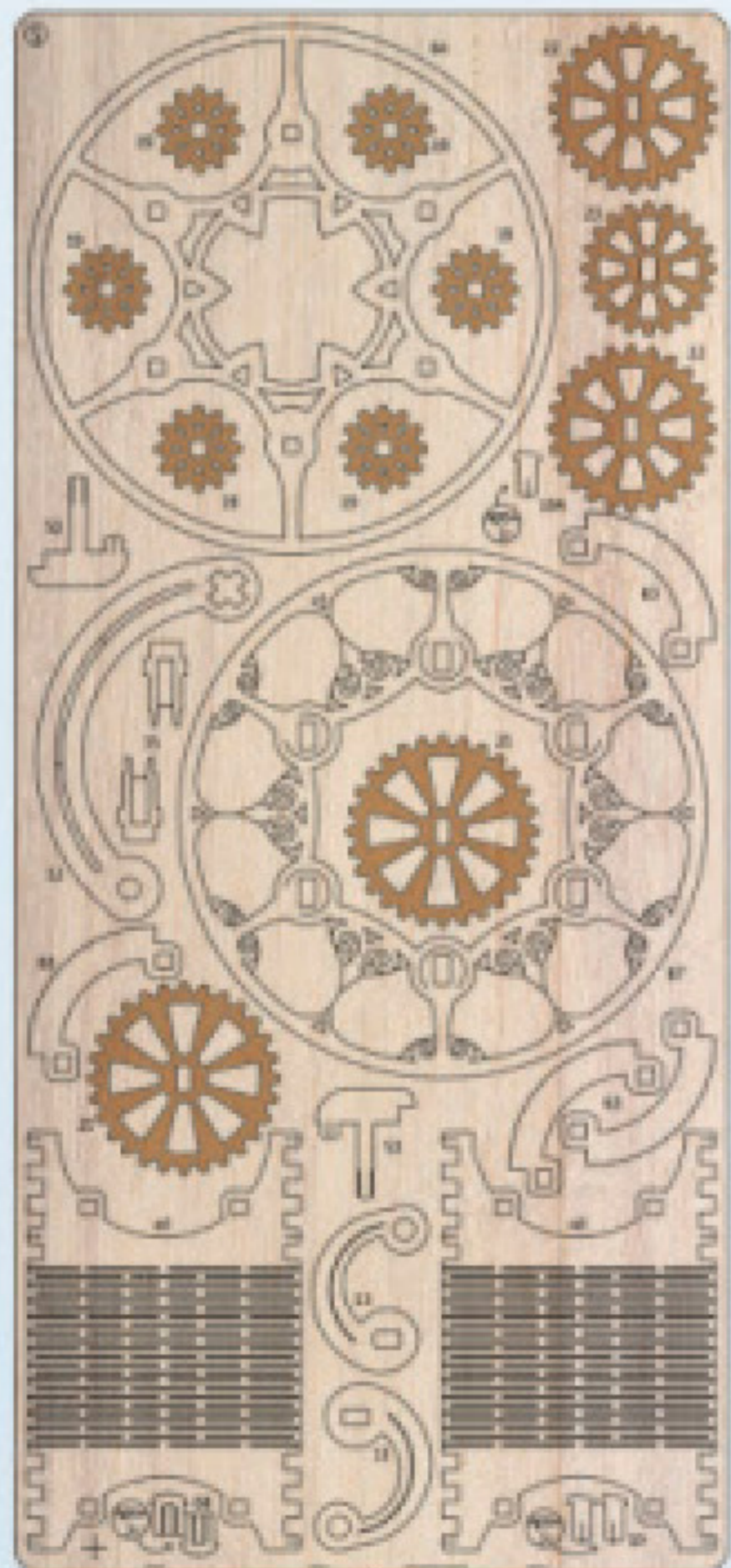

5

3

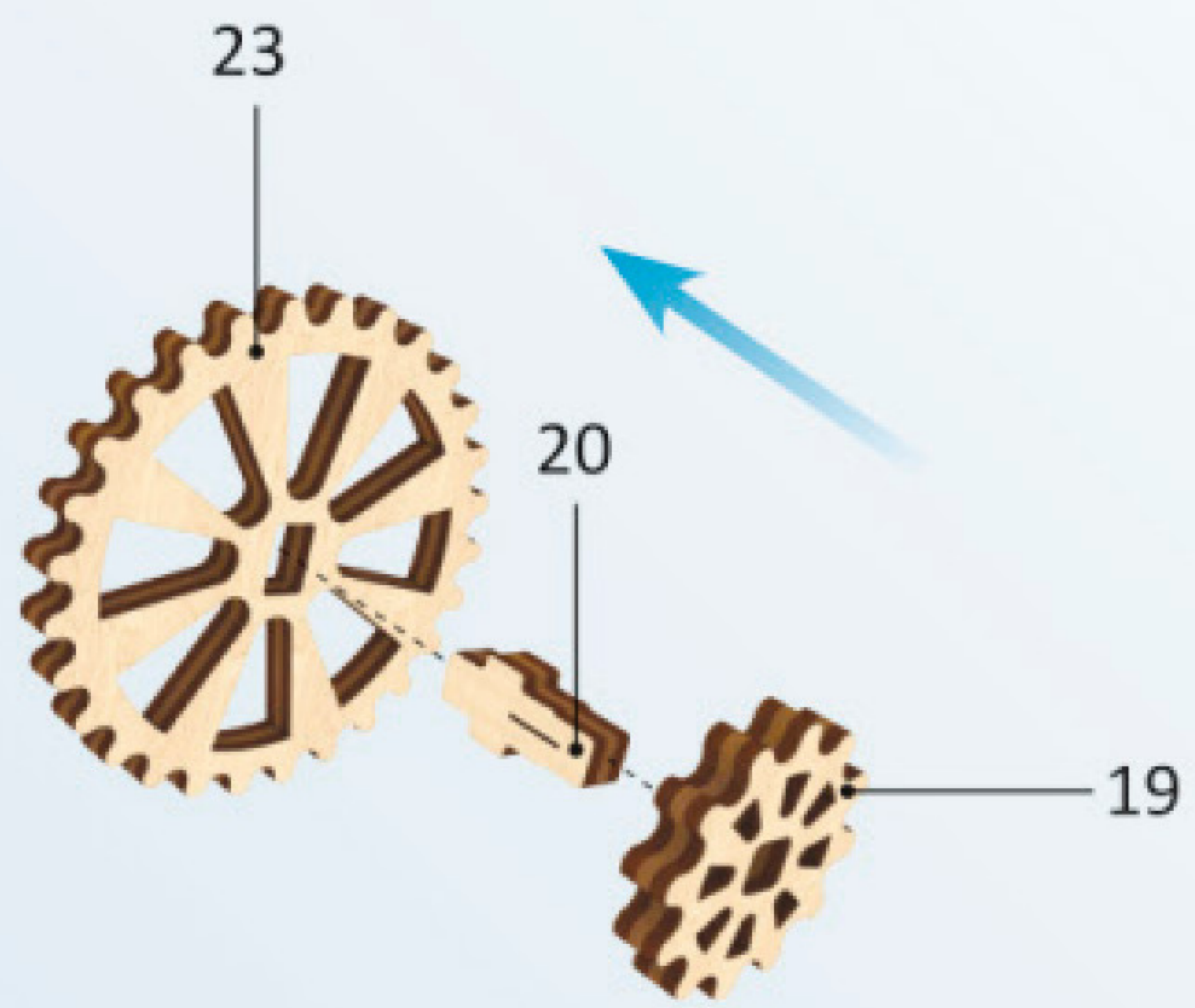

H

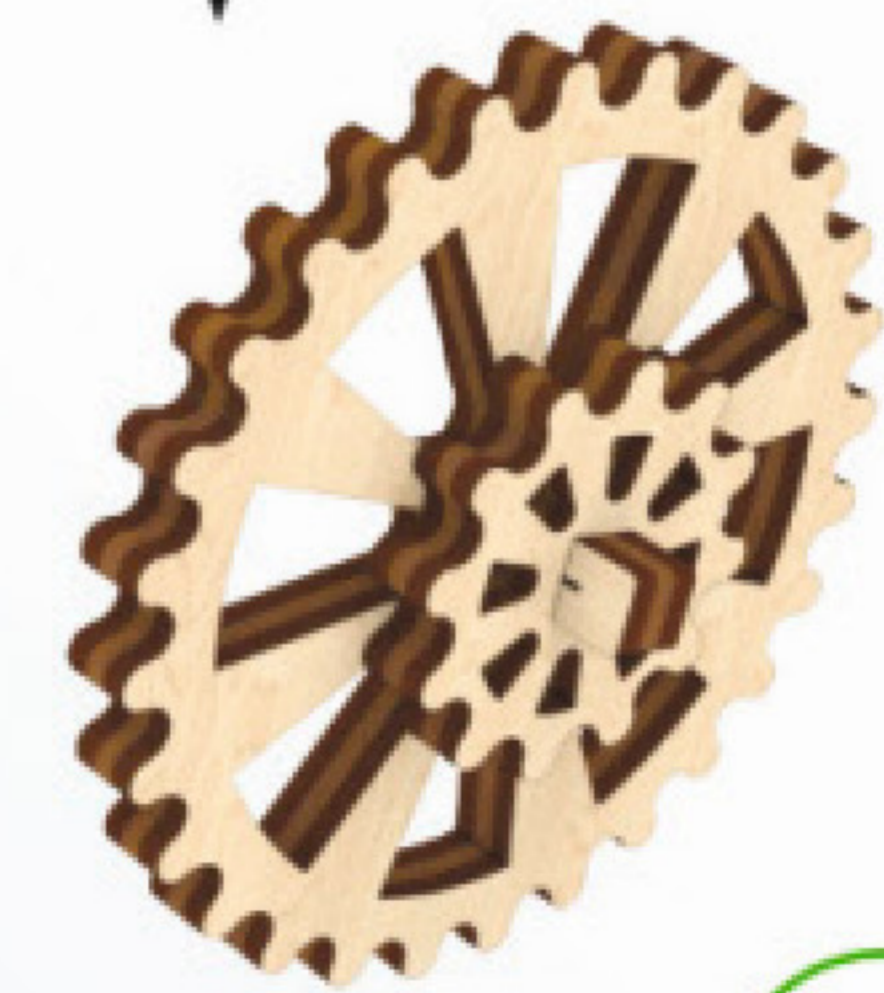

x2



1

2

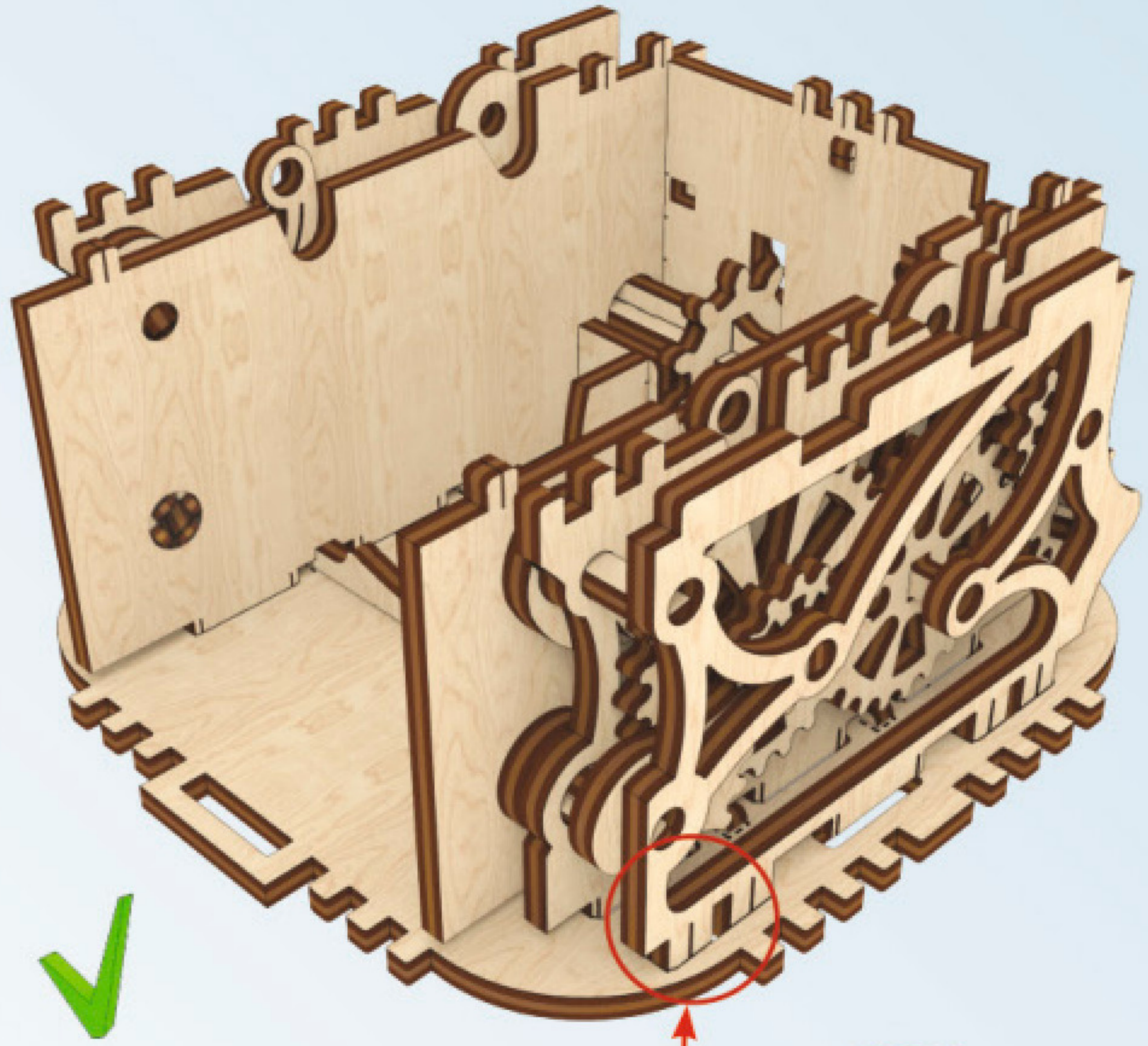
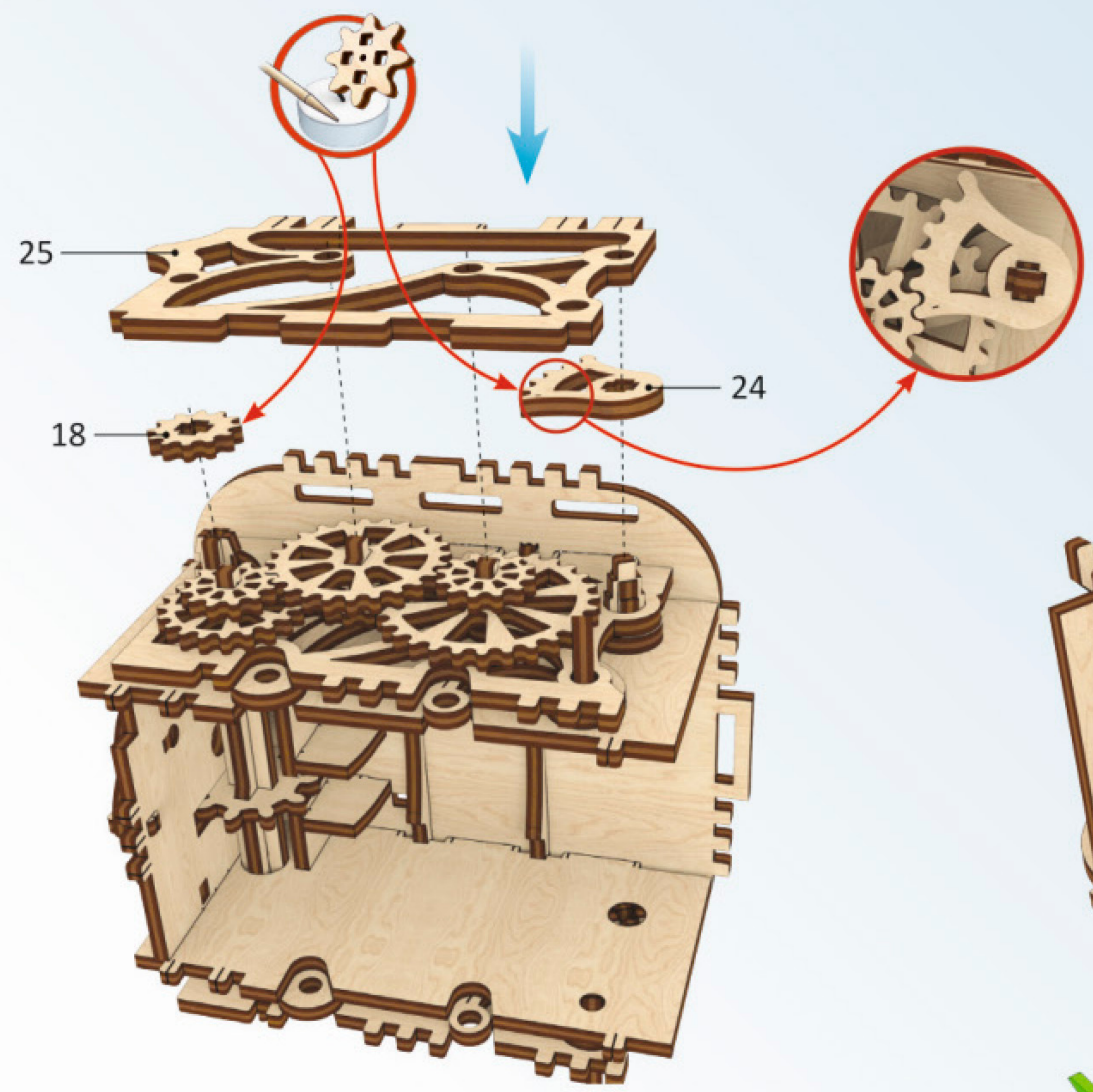
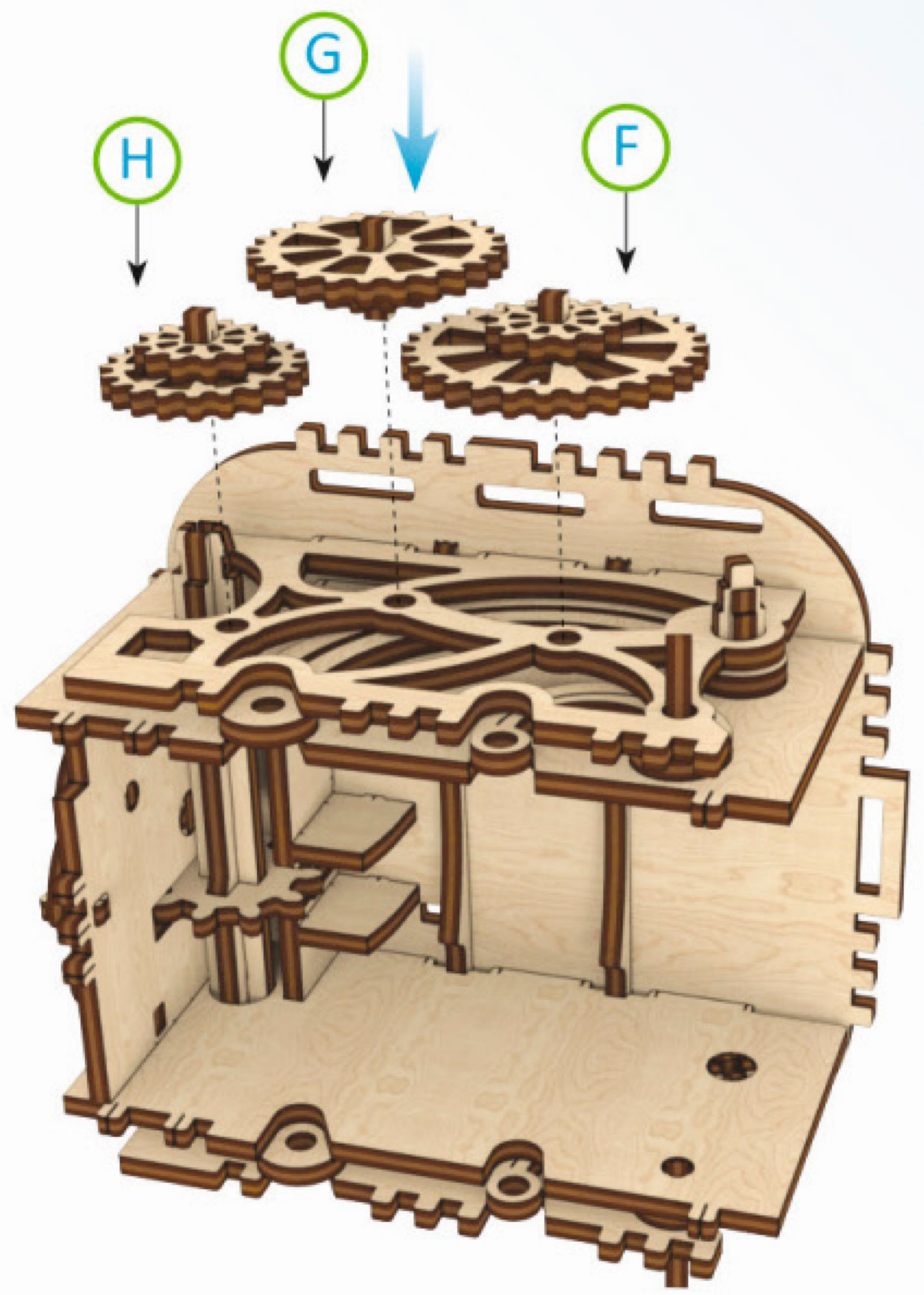
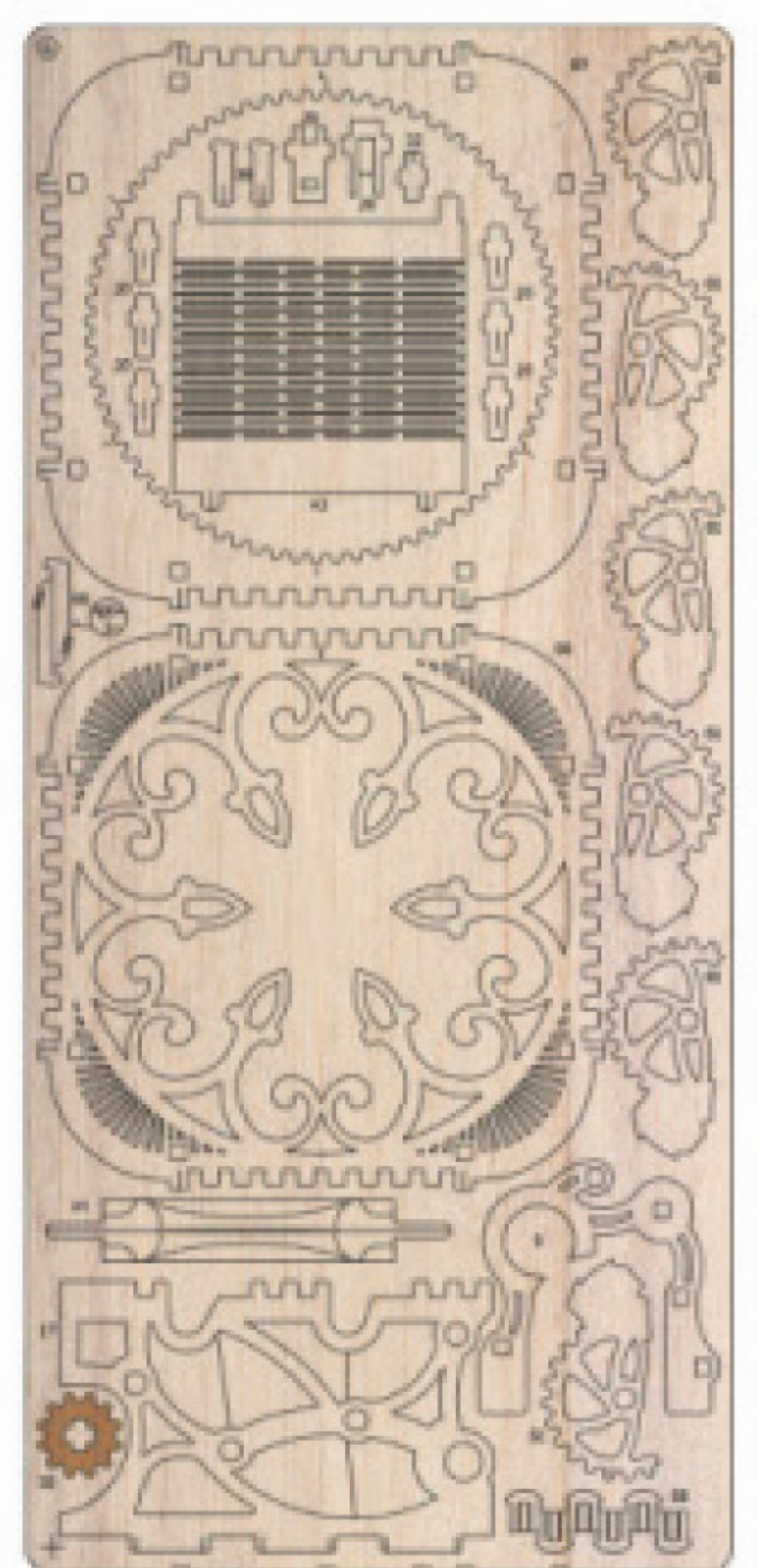
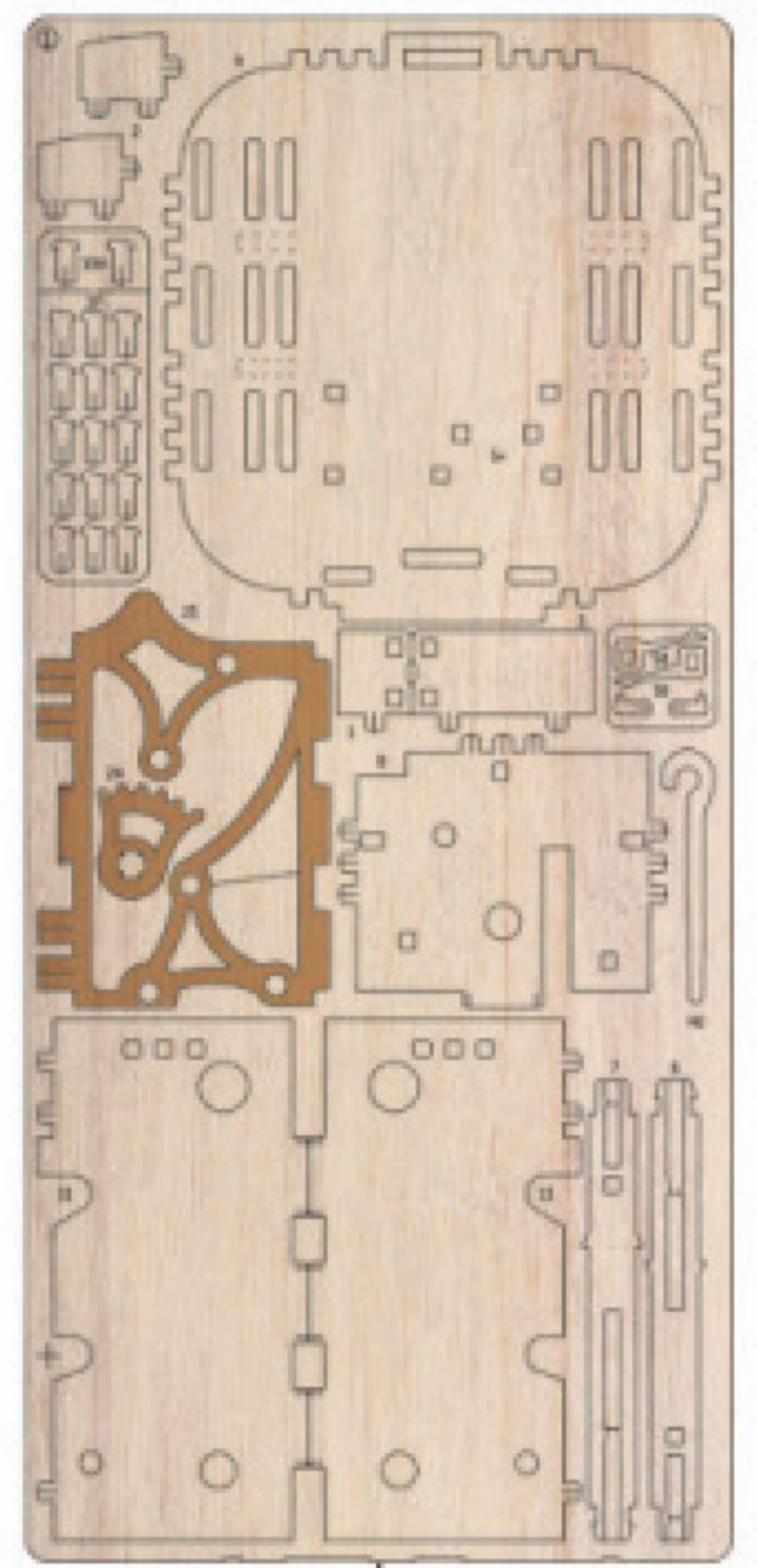

Mechanical models

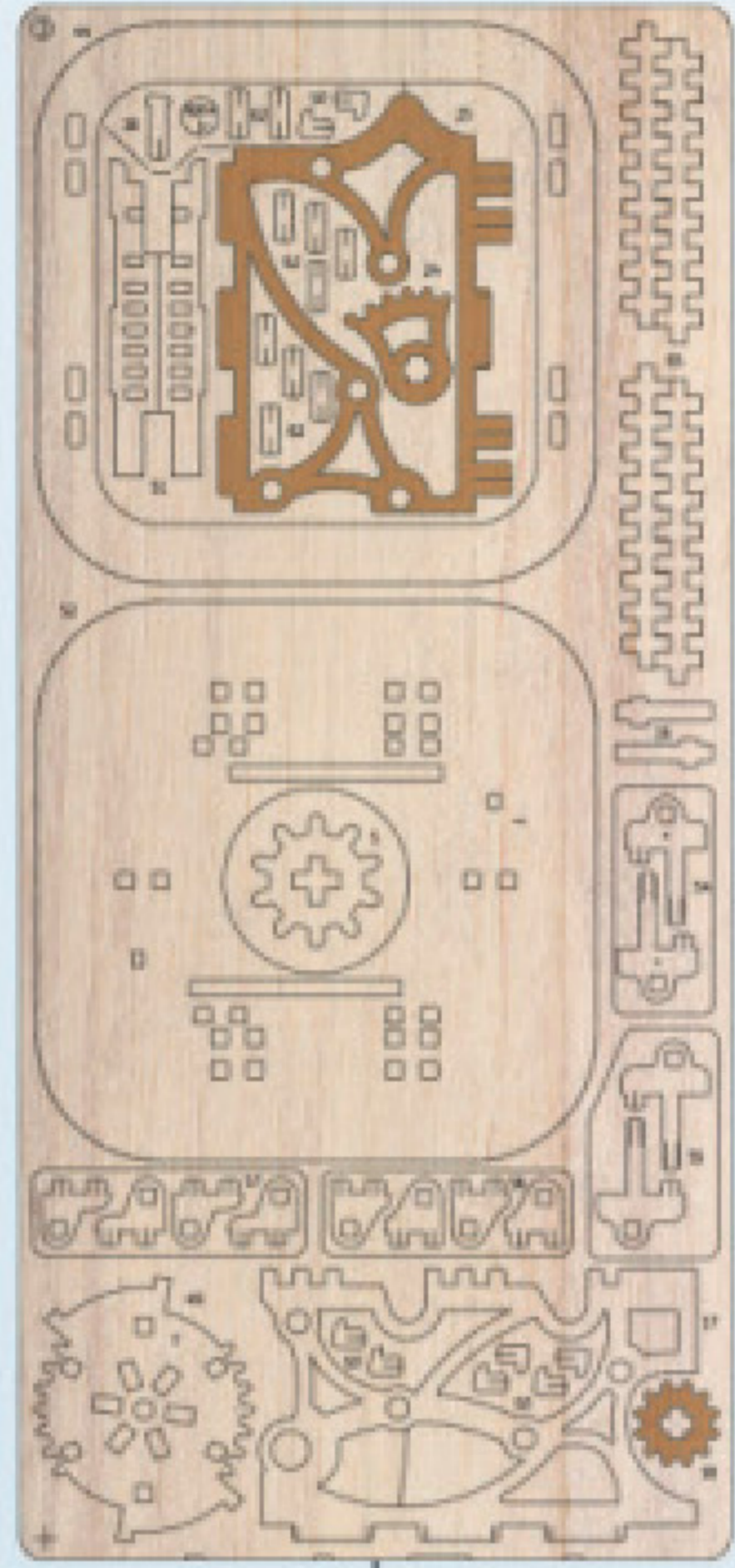

3

1

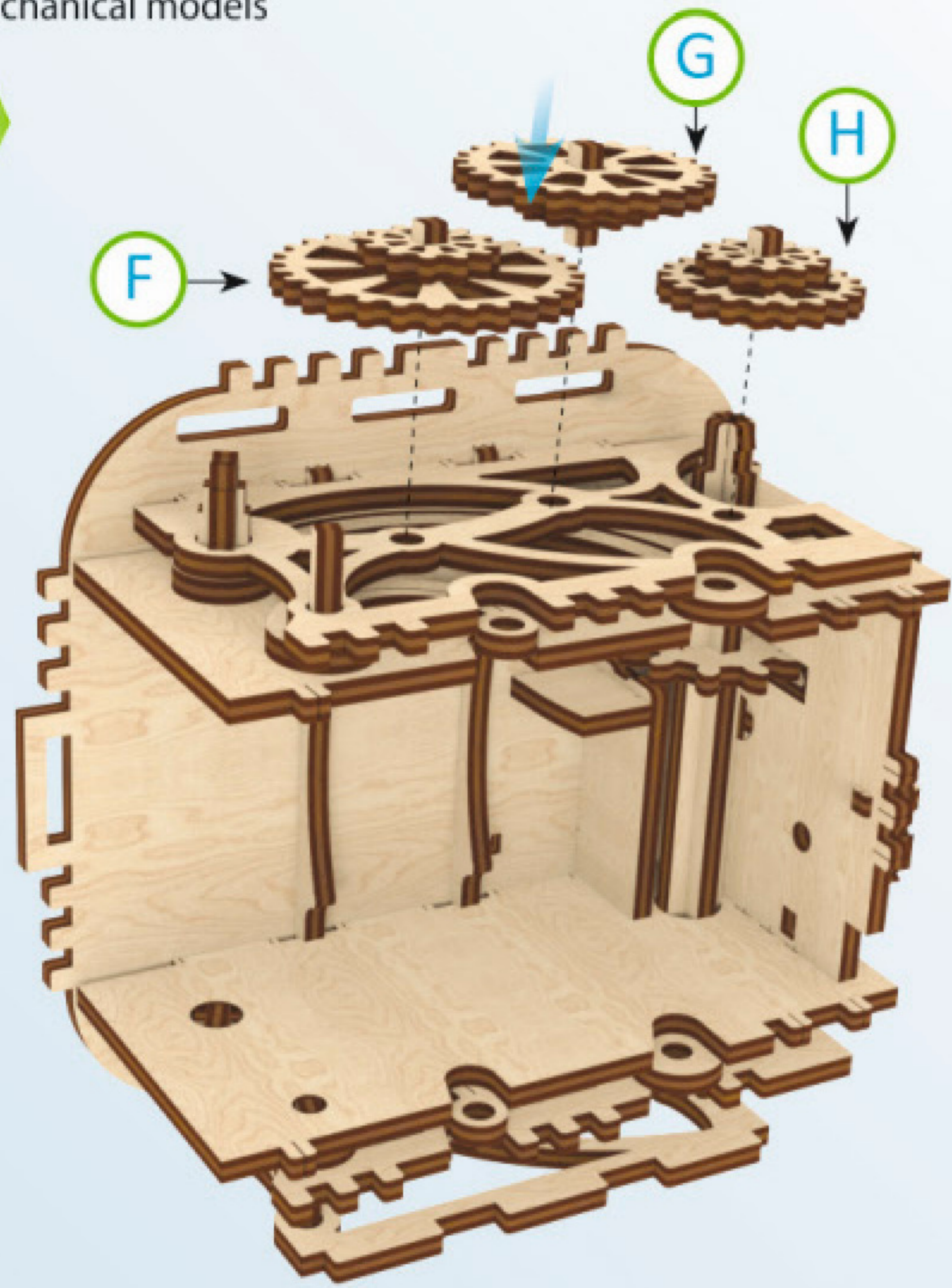

2

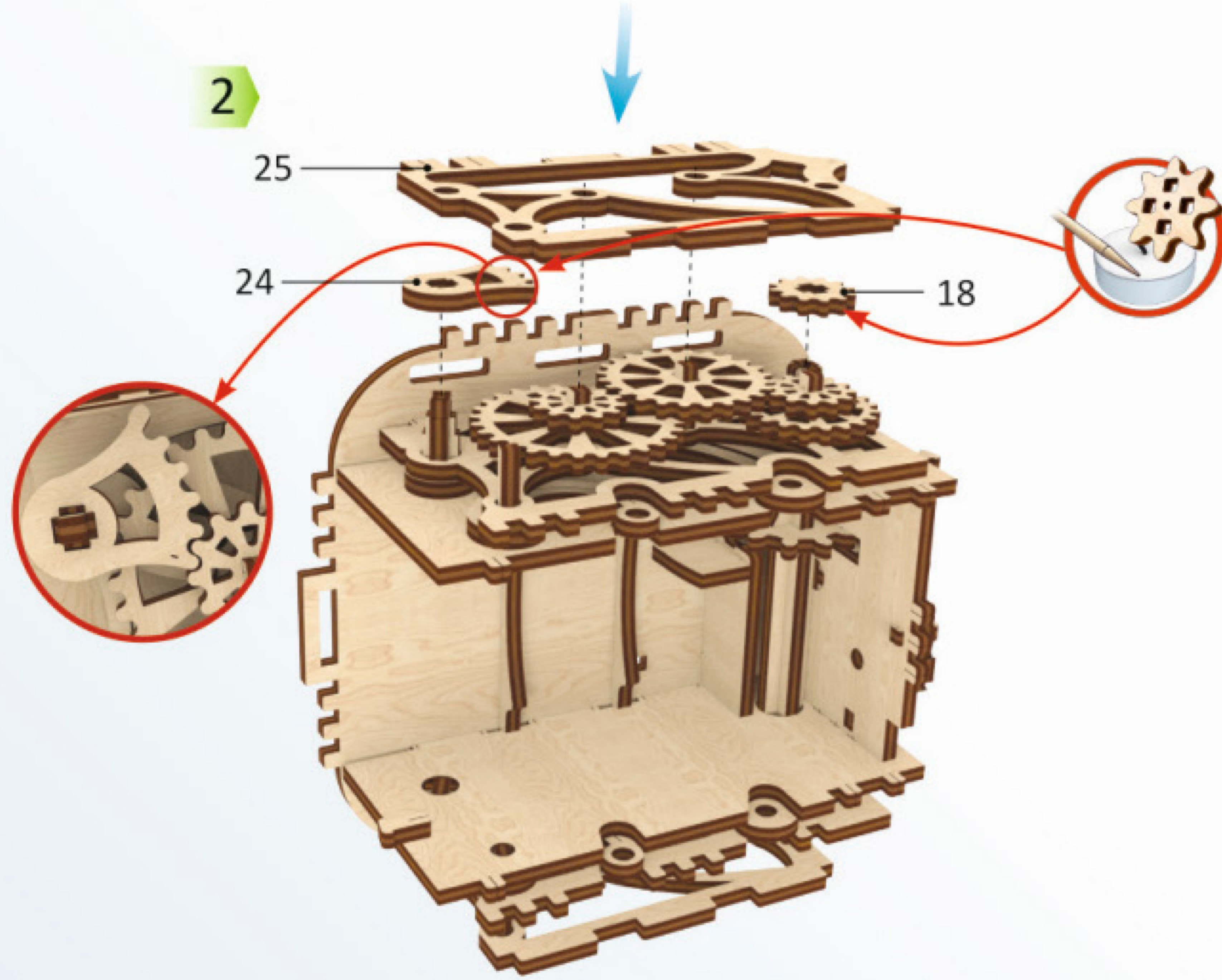

3

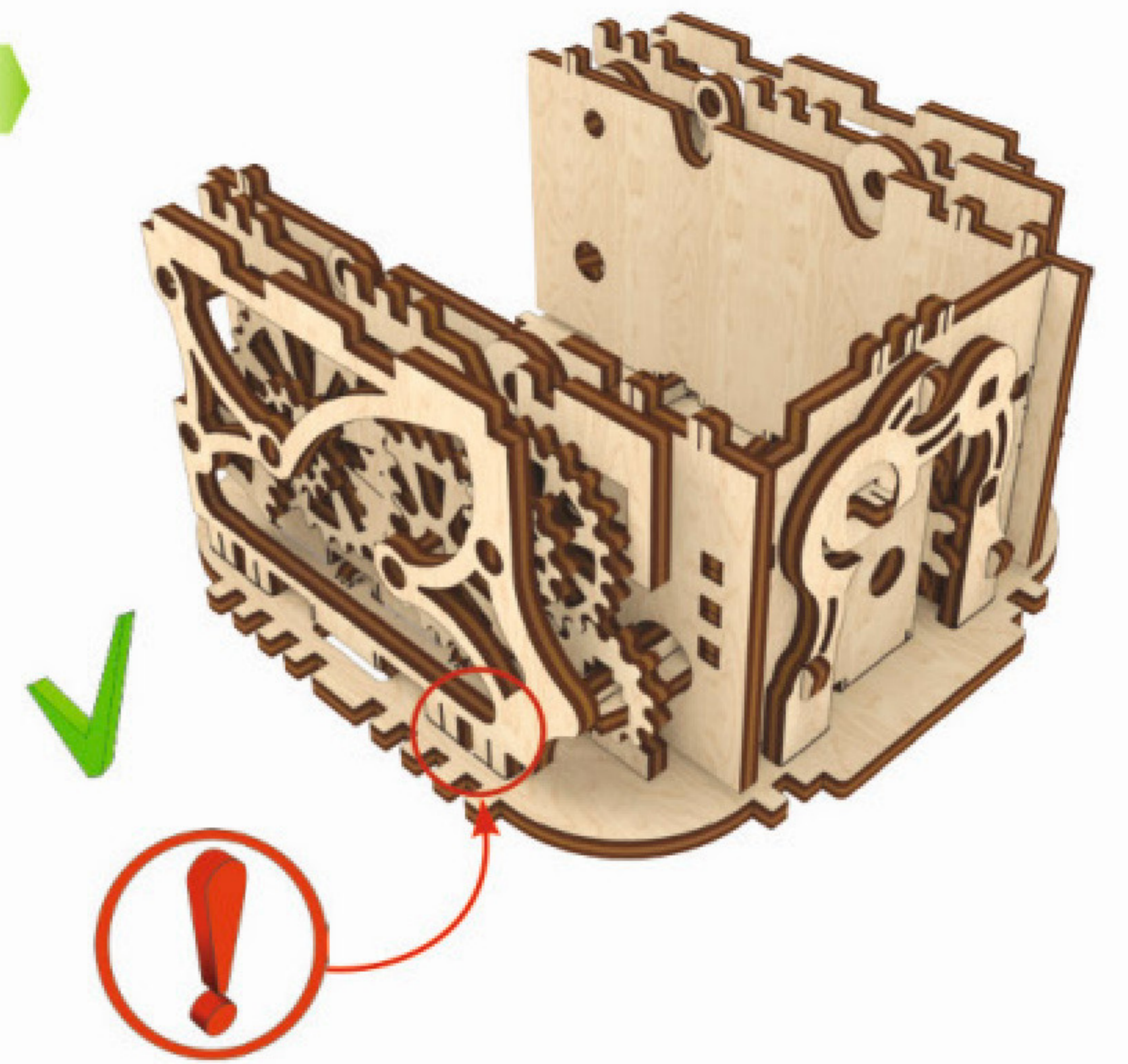

4

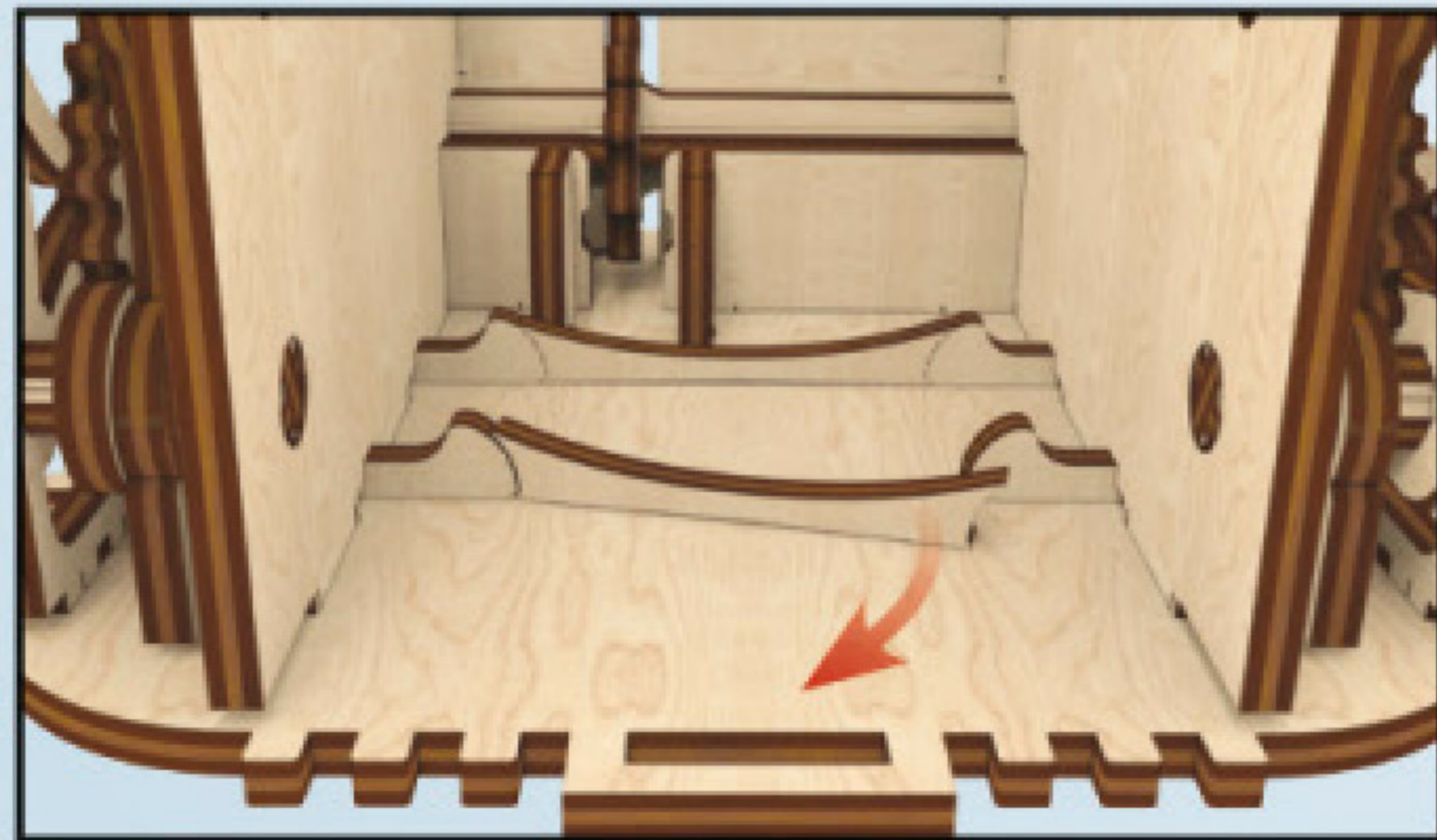

5

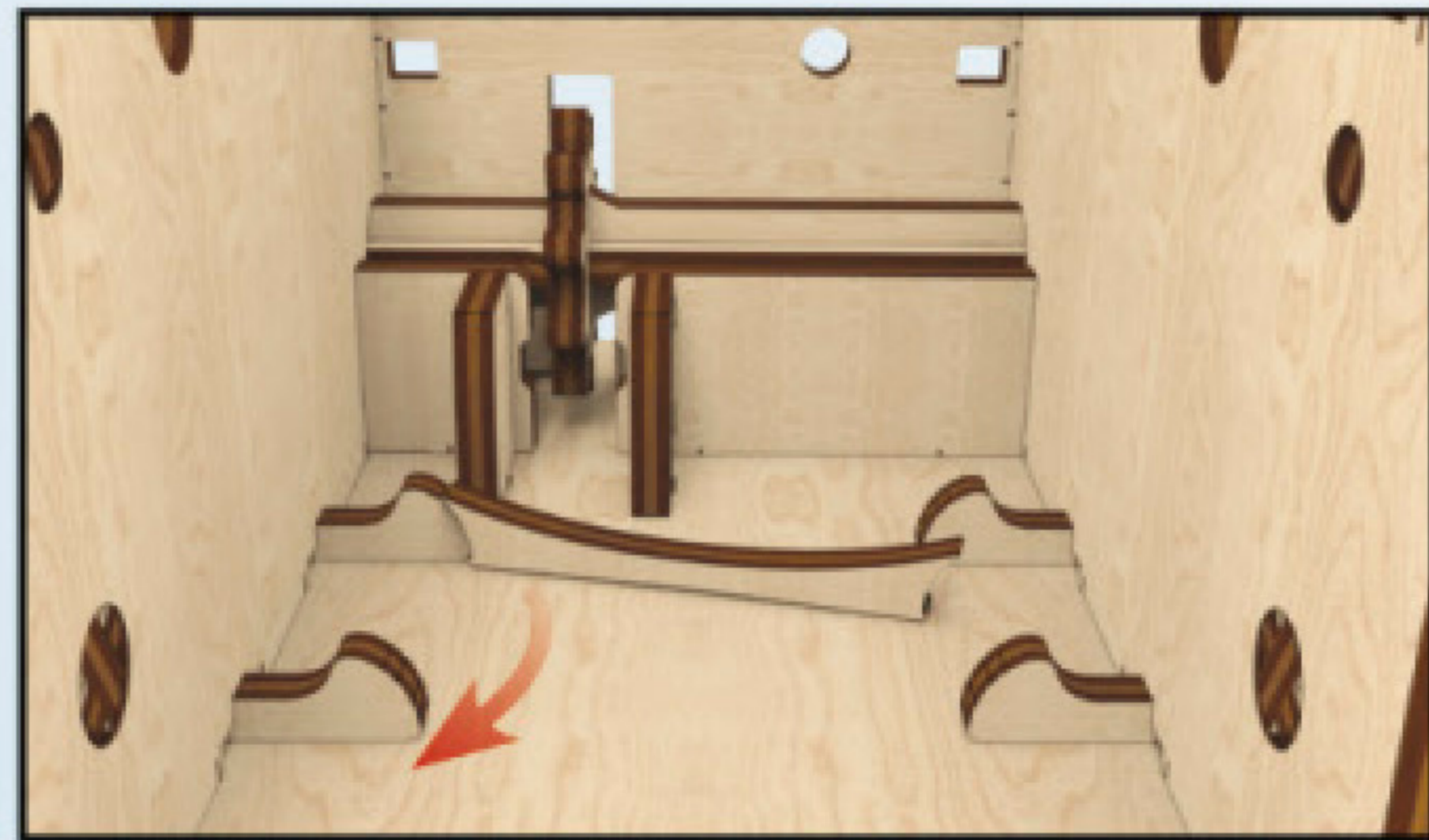

6

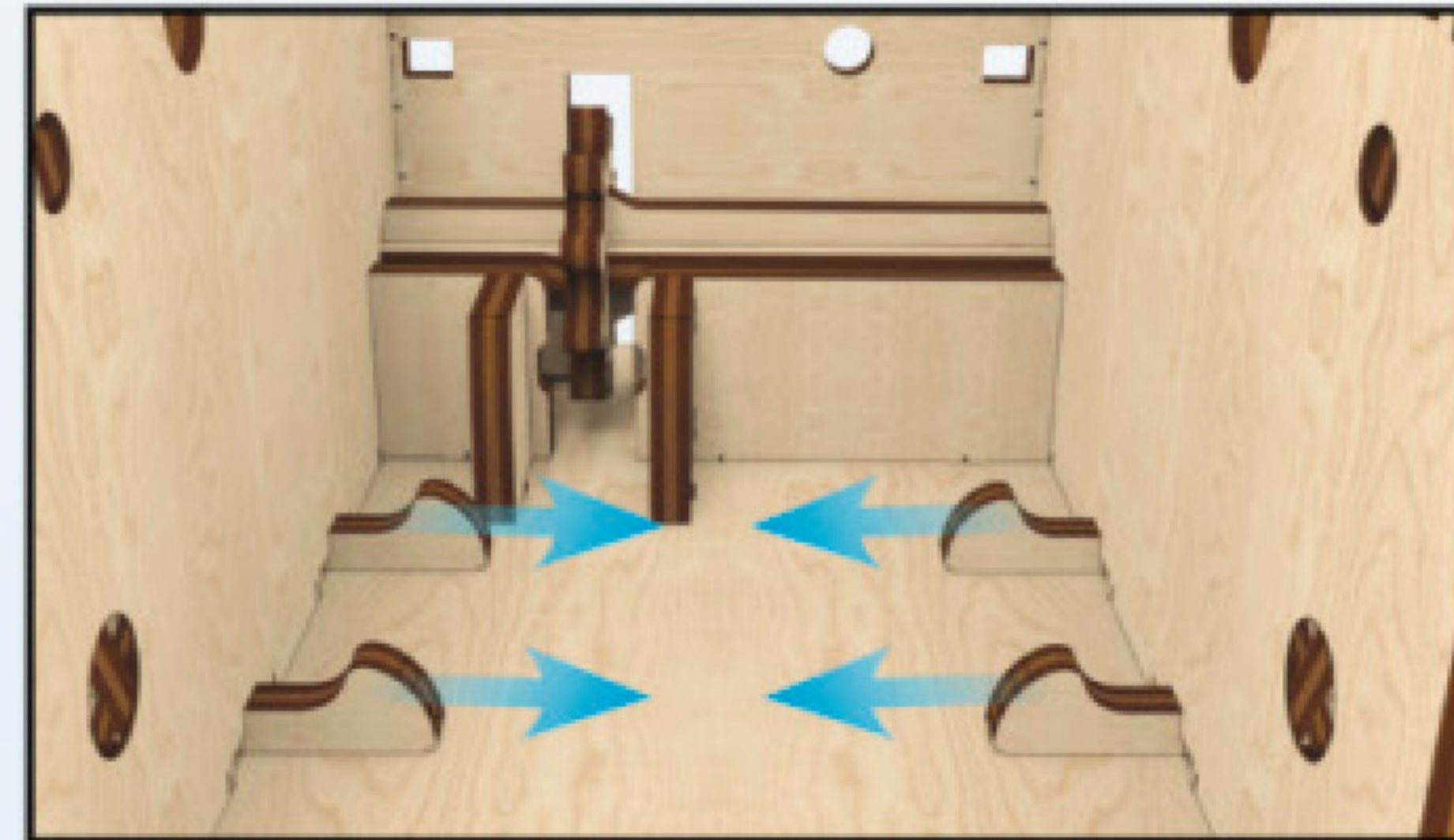

7

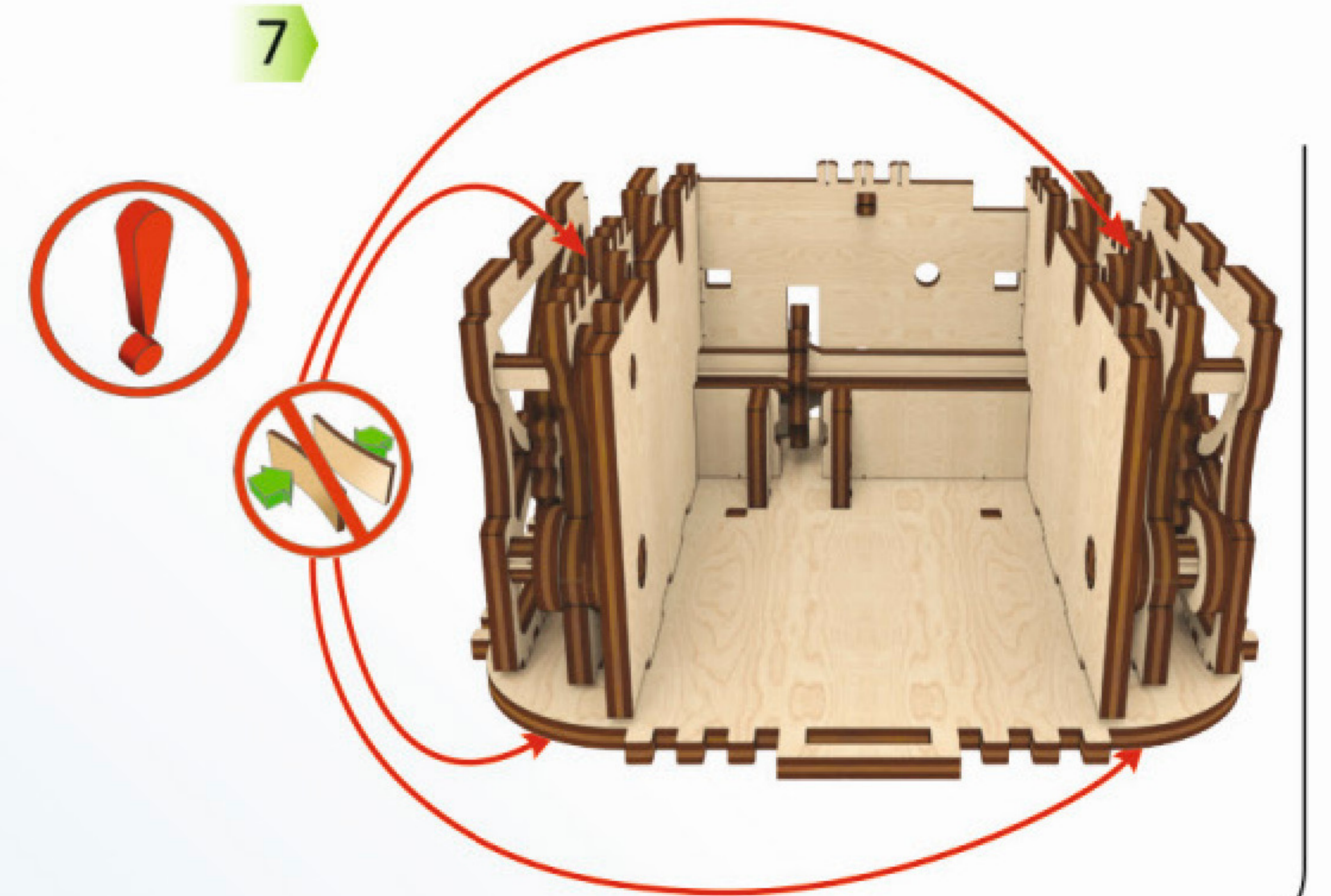

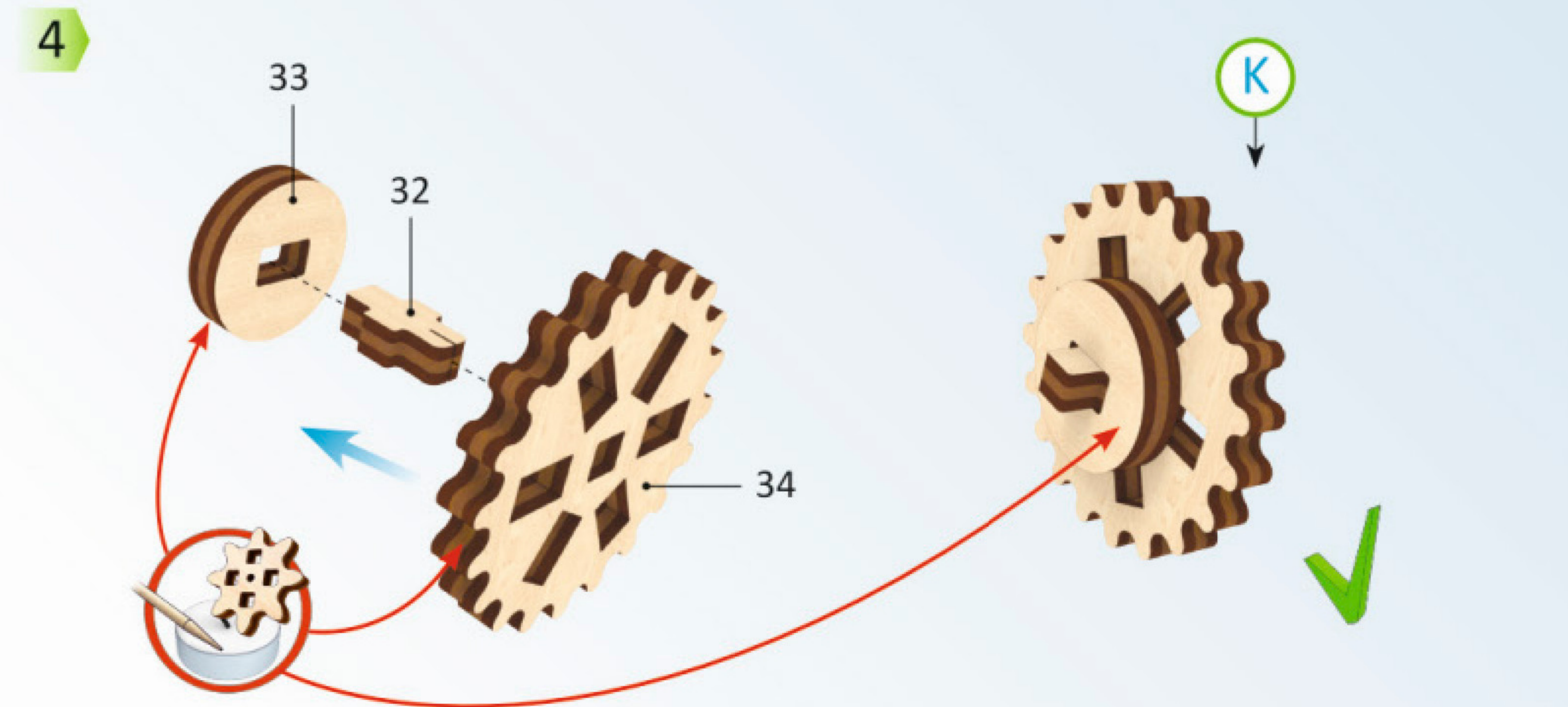
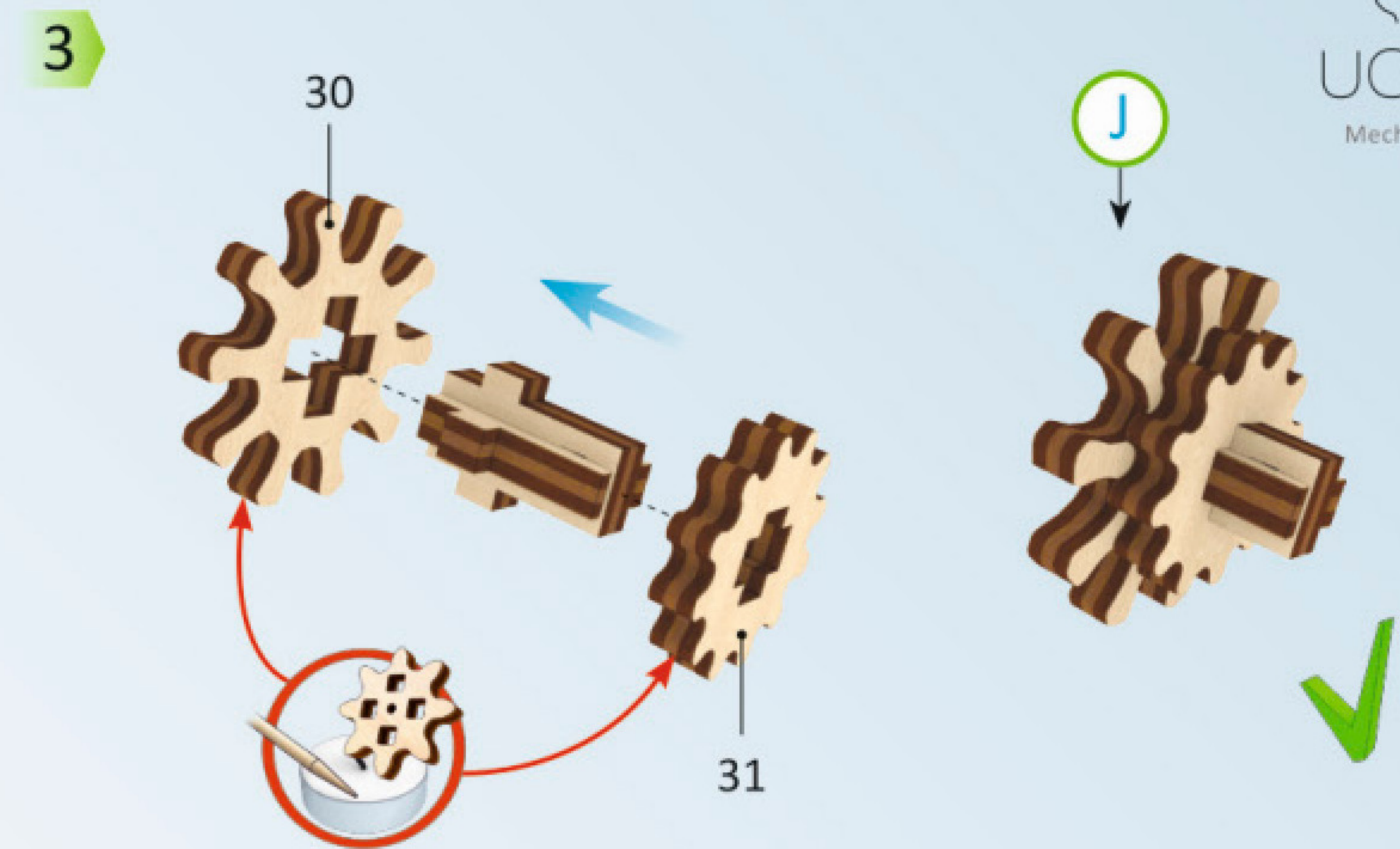
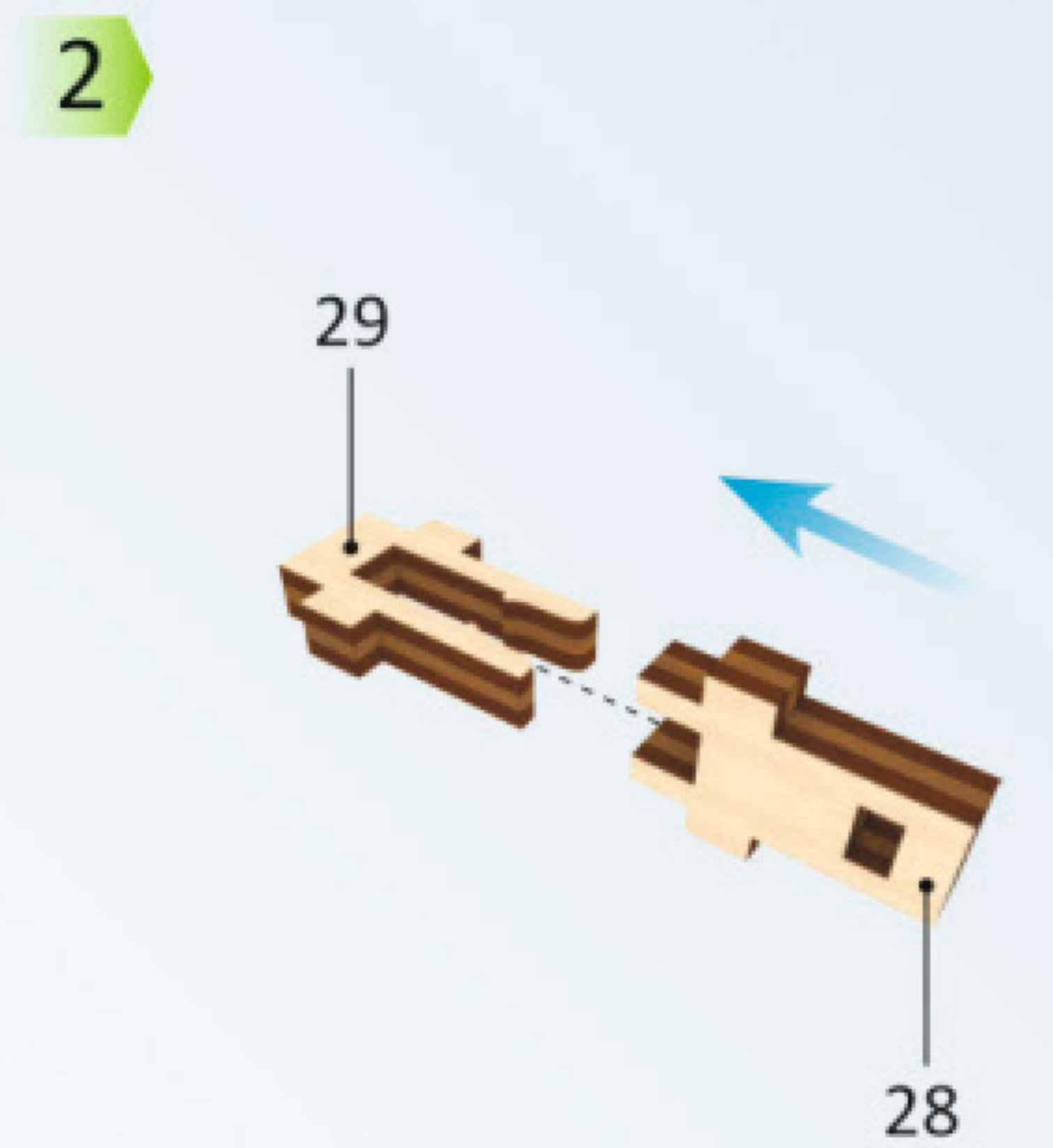
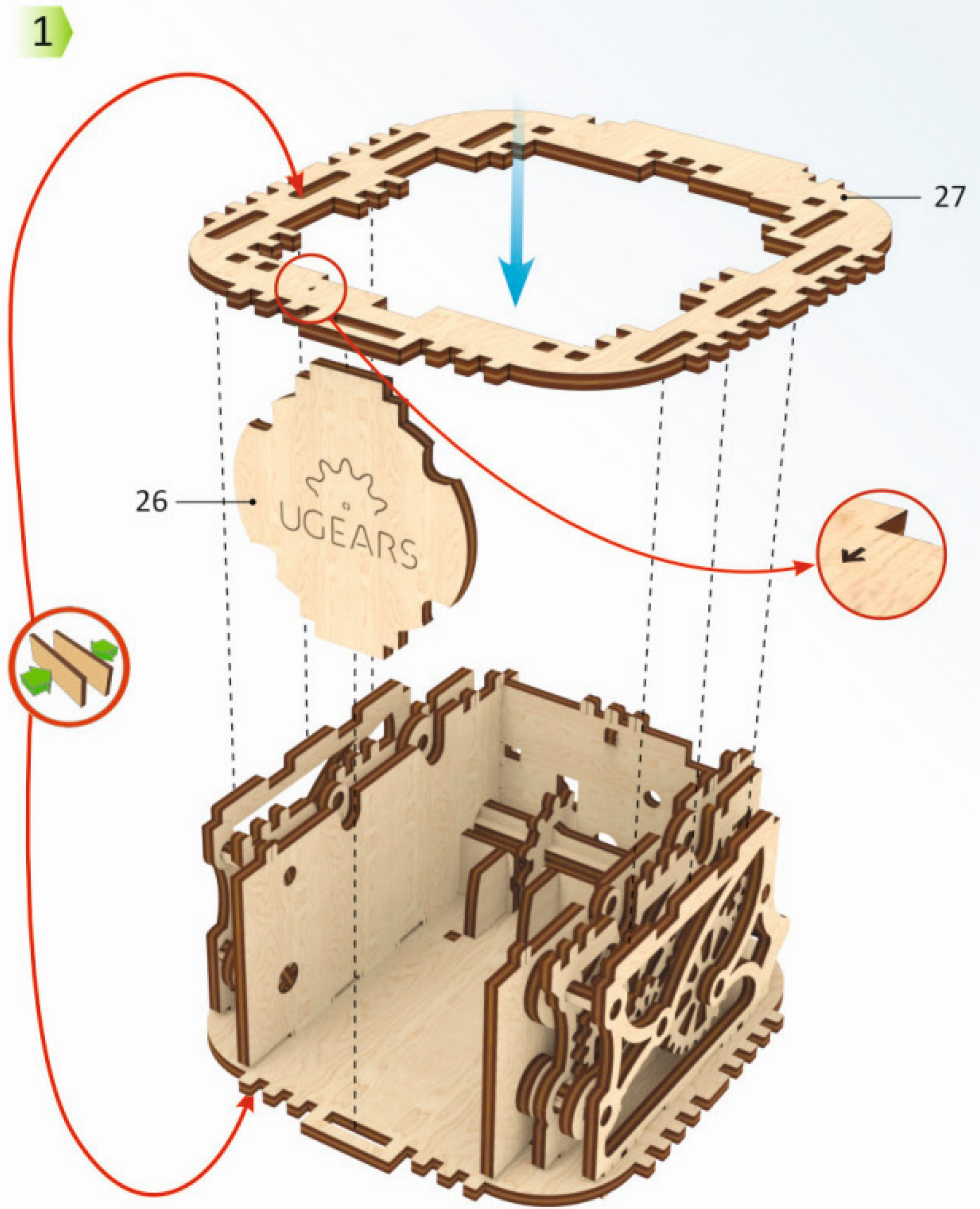

Mechanical models



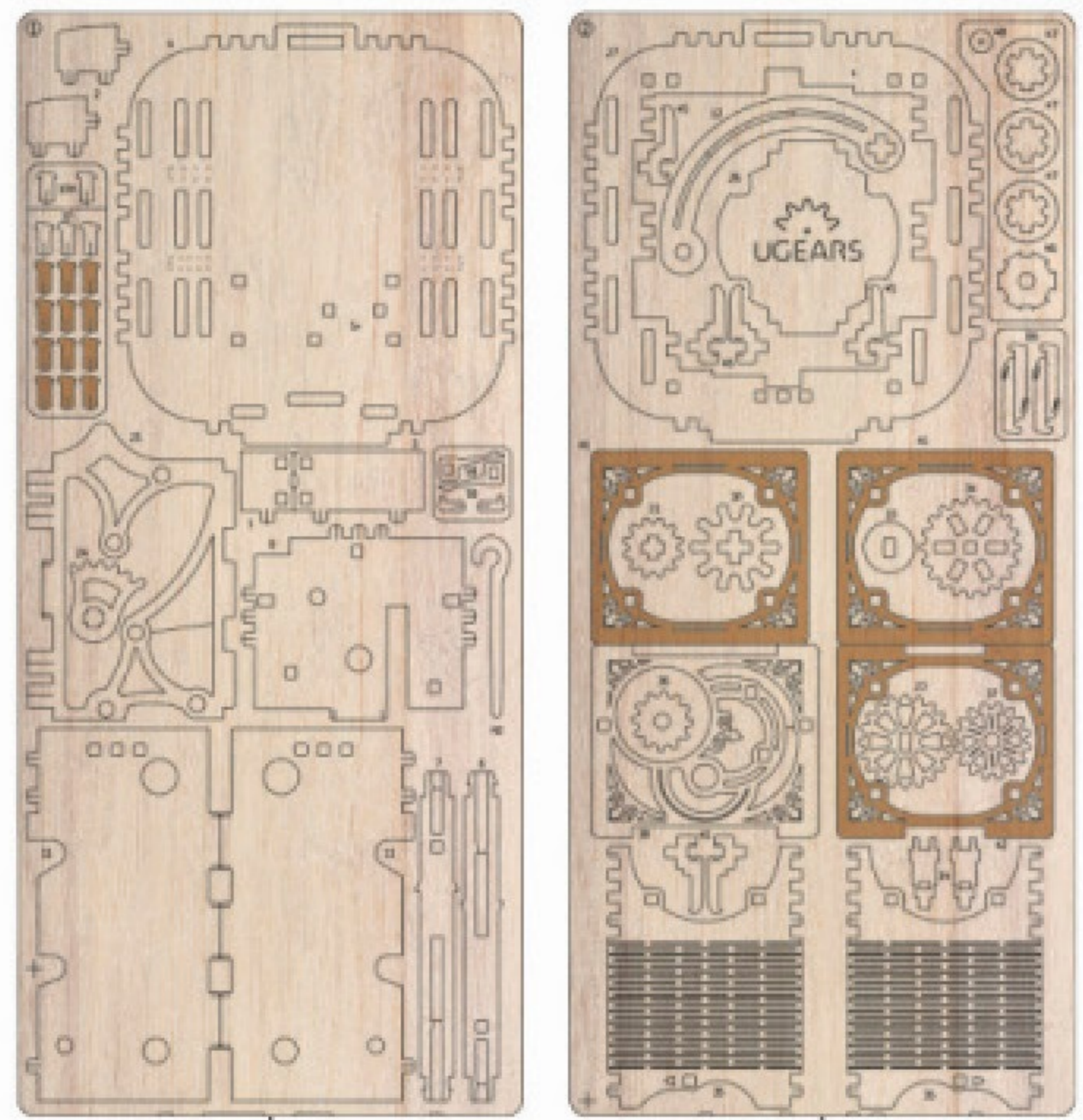

1

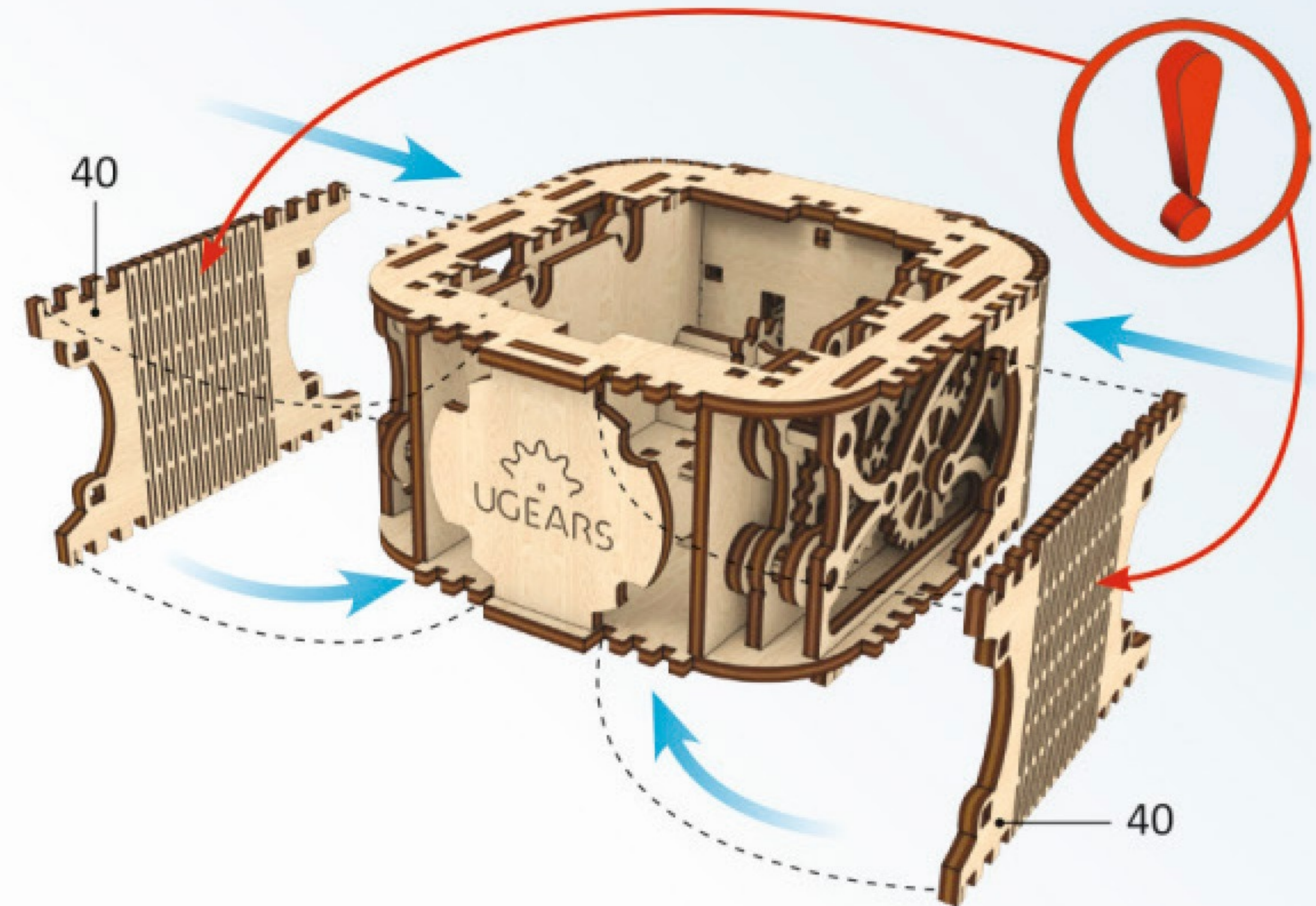

Pas op!  
Buig niet te hard!

2

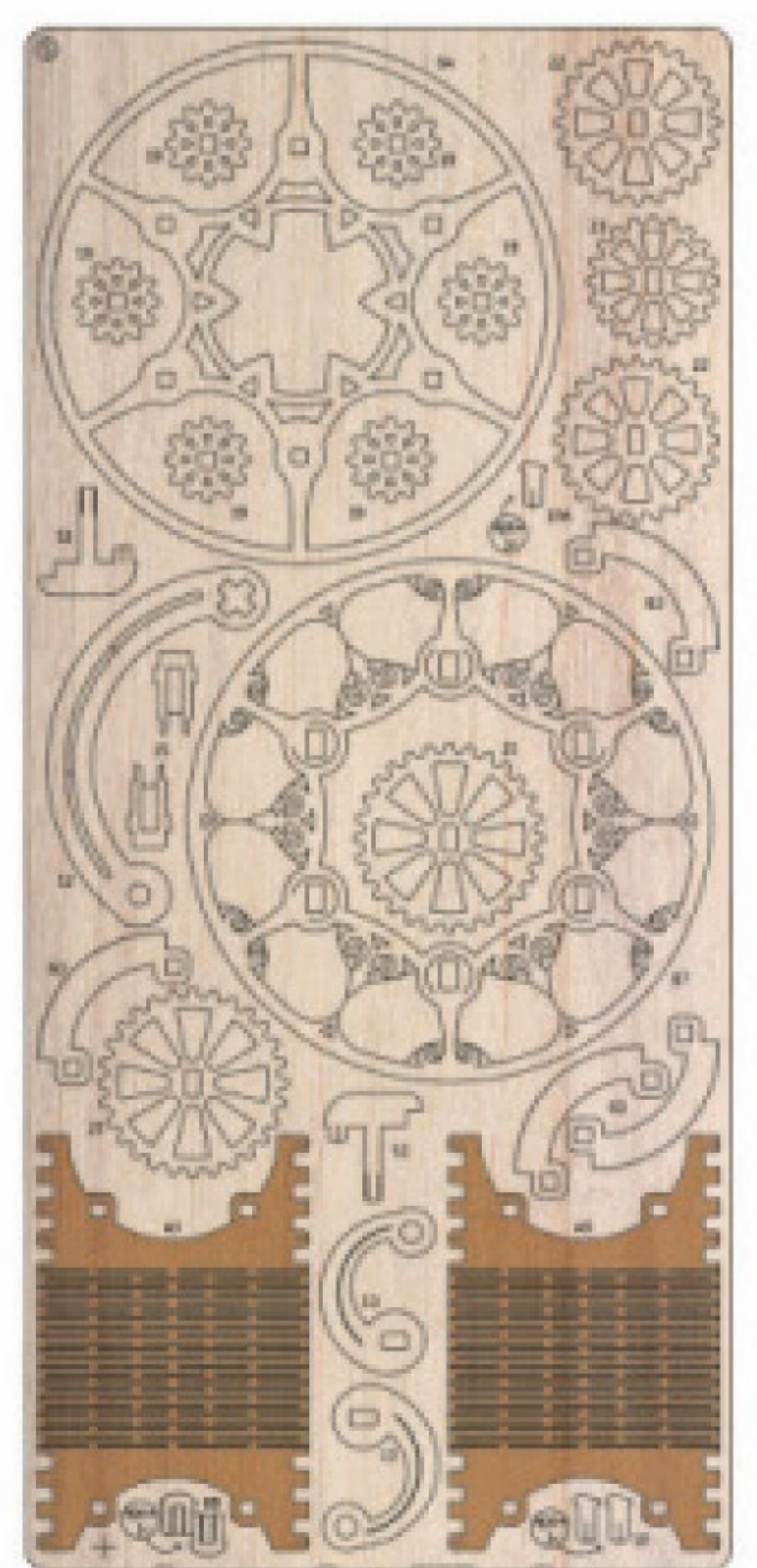
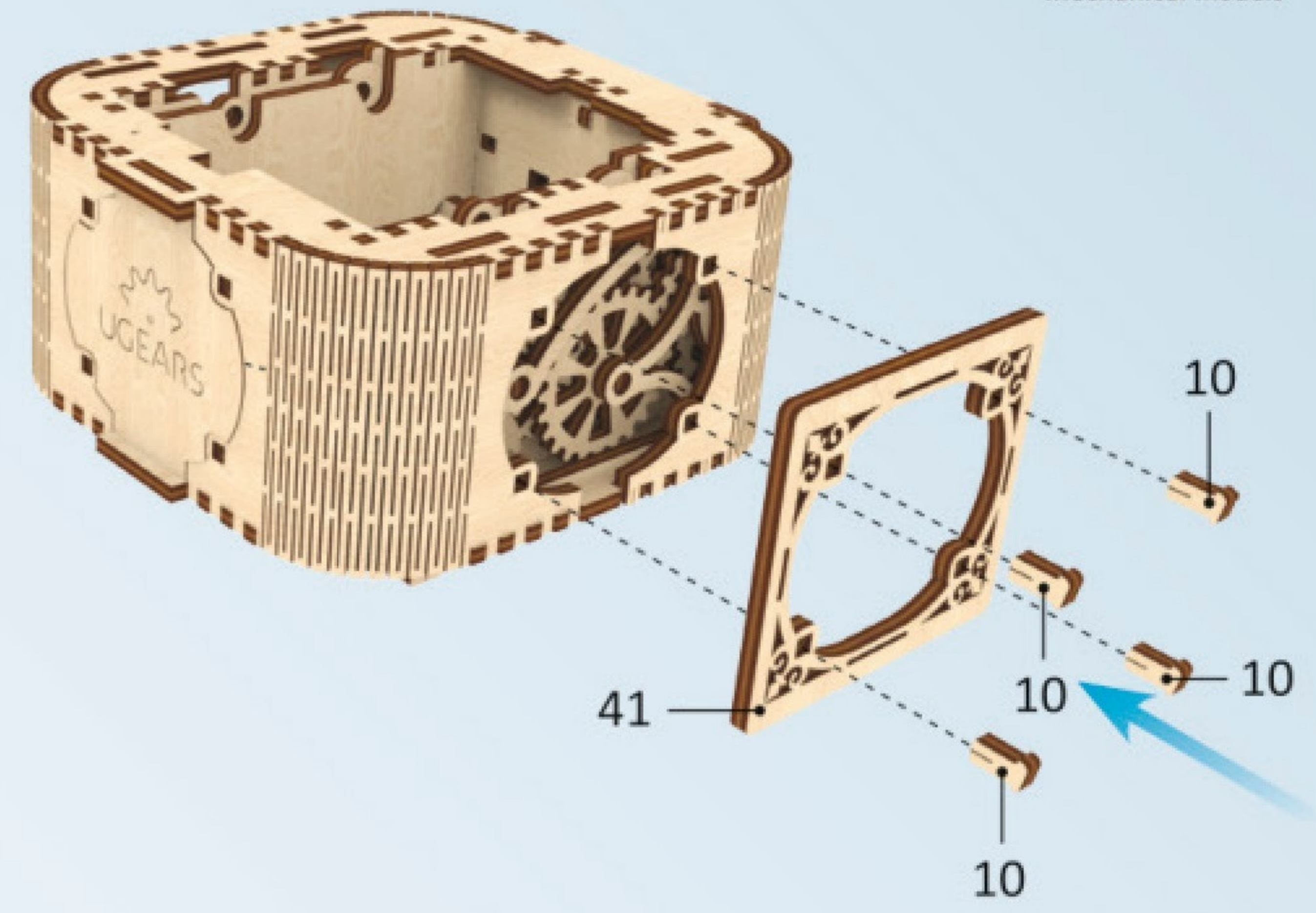

3

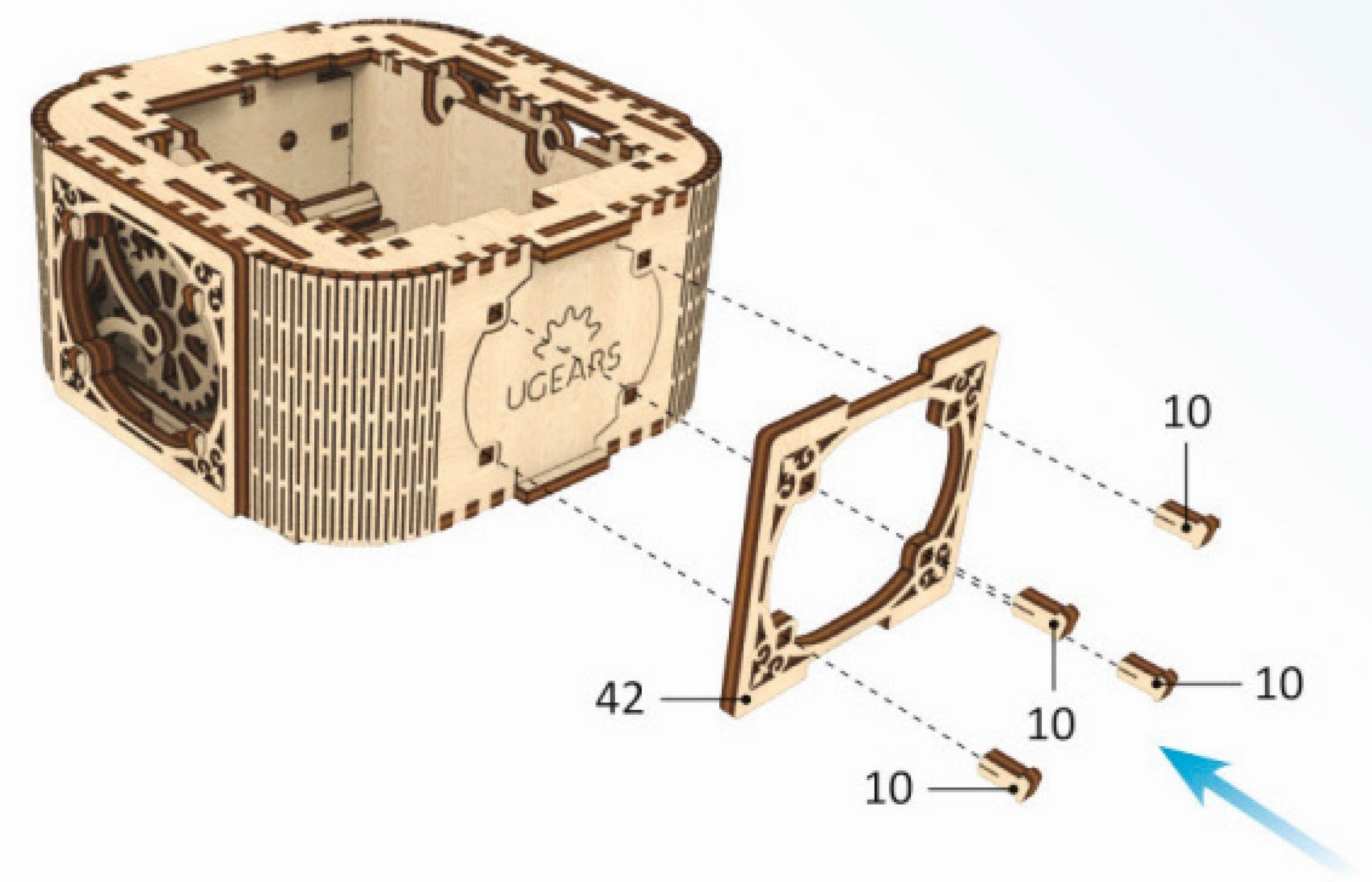

4

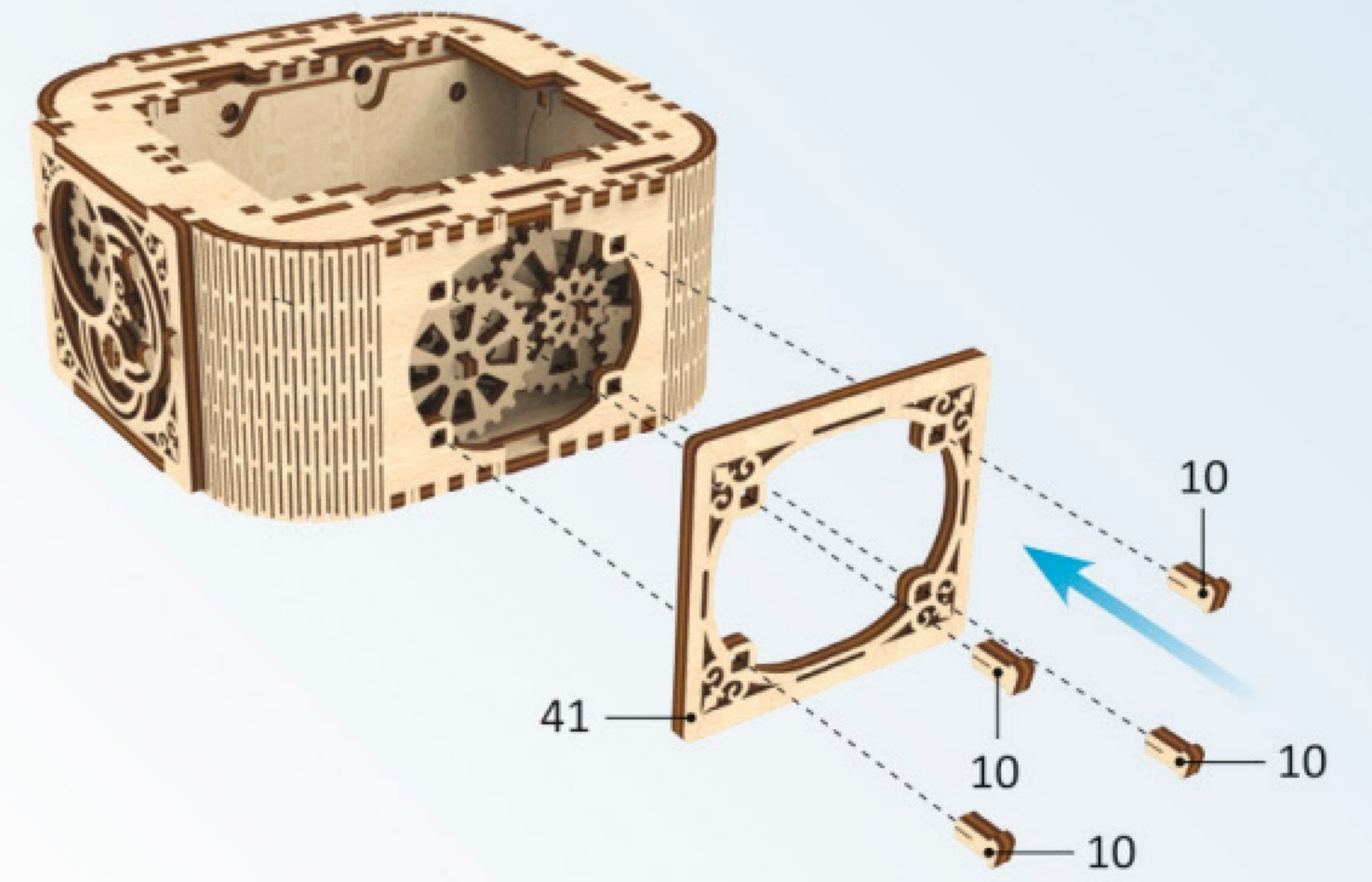

1

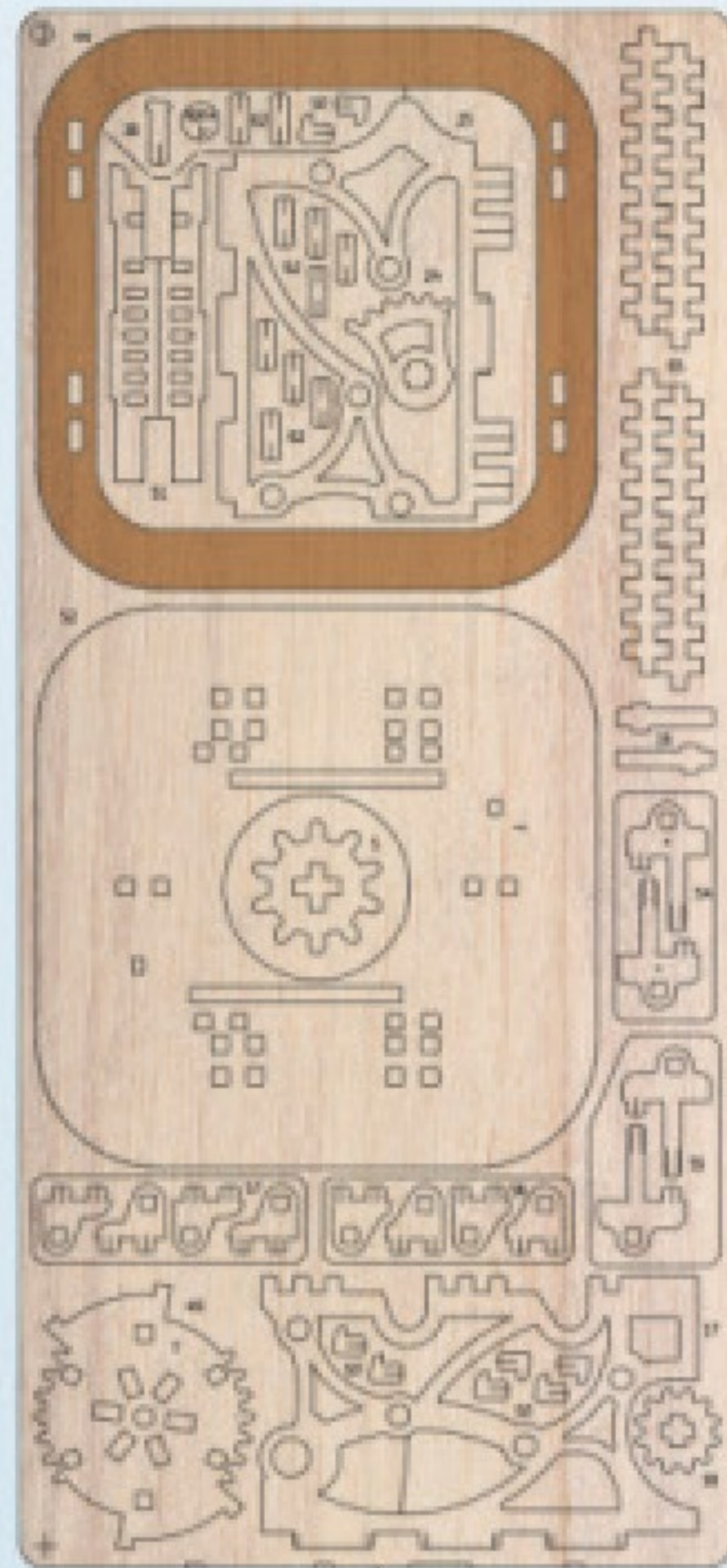

3



4

14

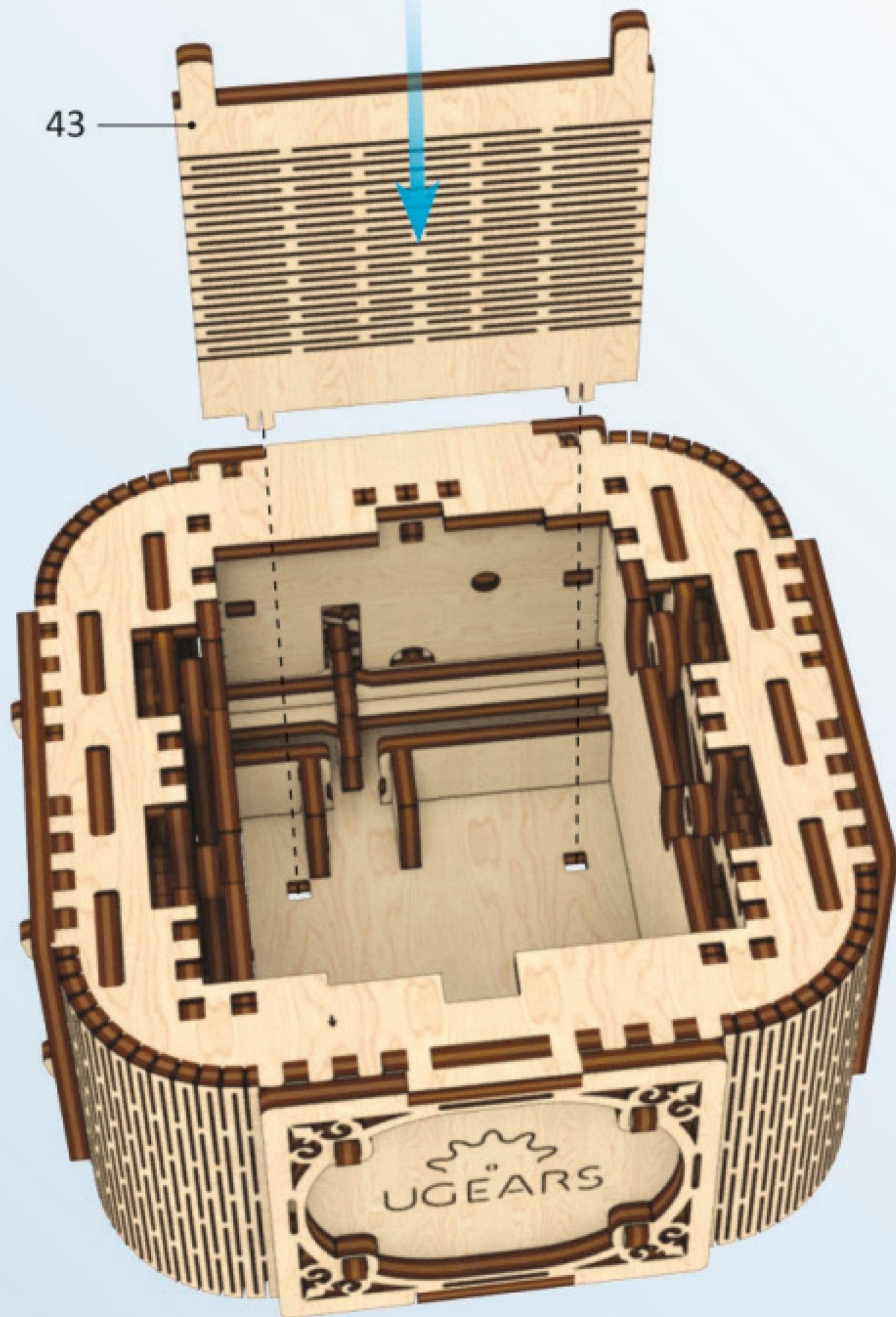

2

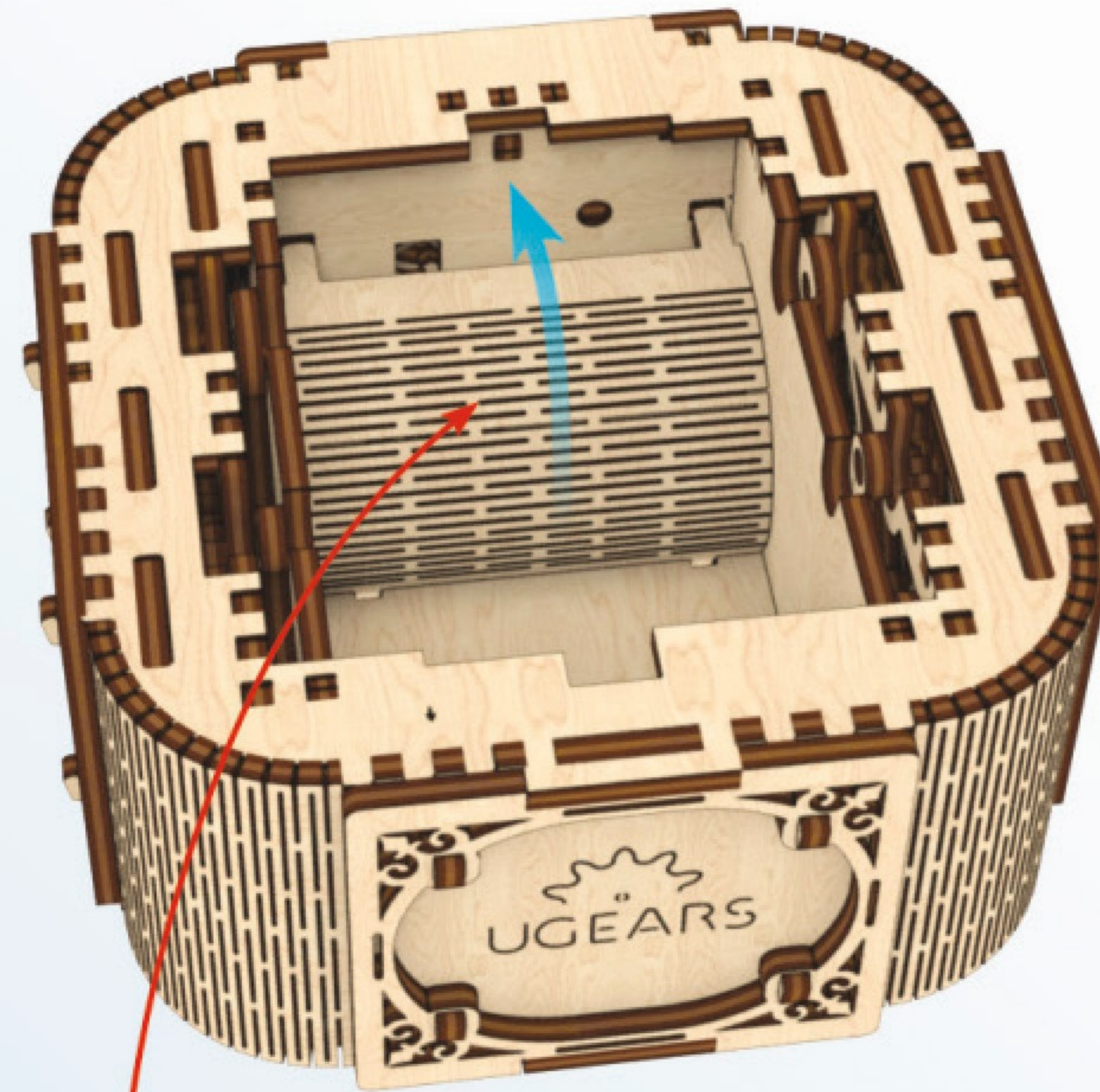

Pas op!  
Buig niet te hard!

3

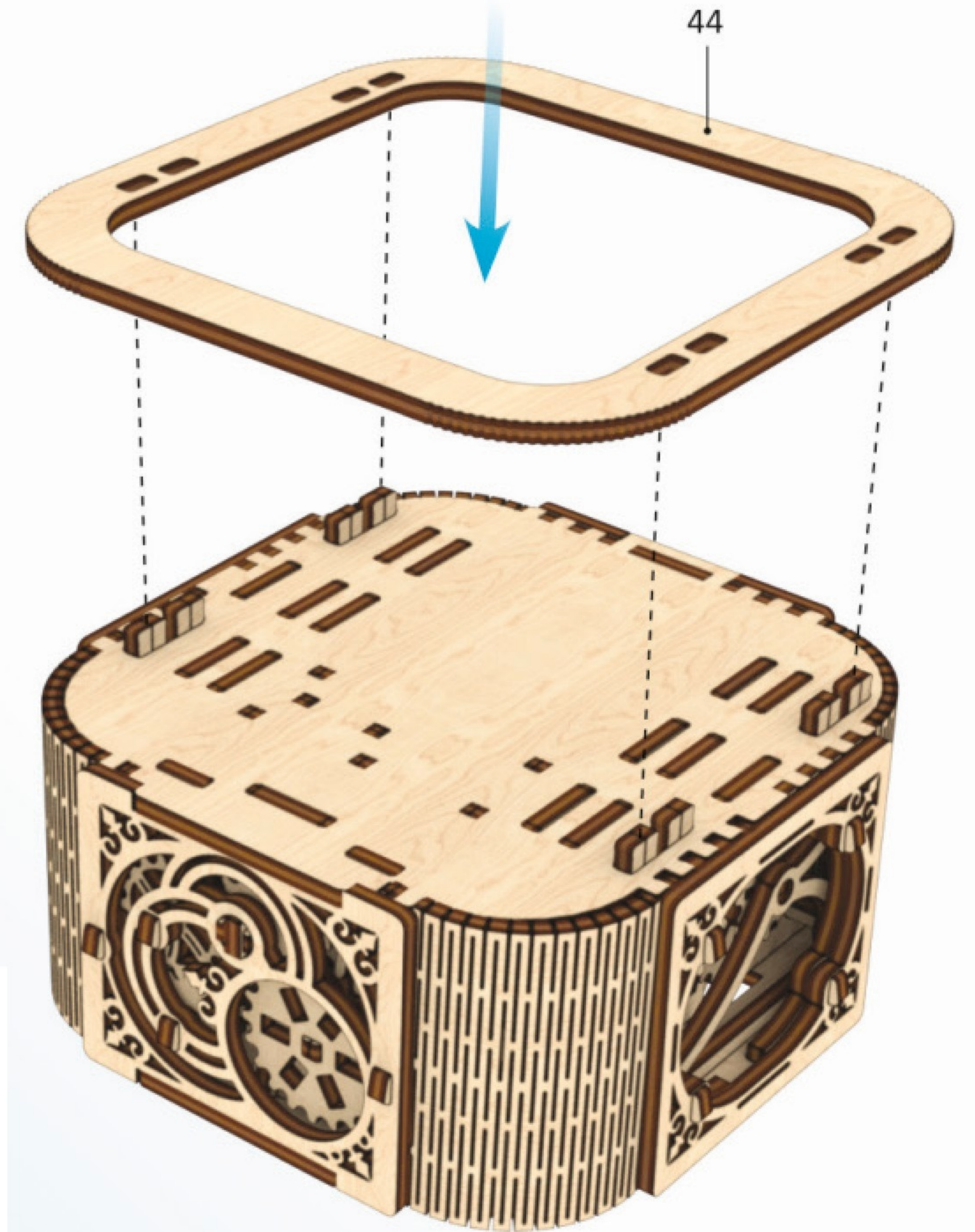

44

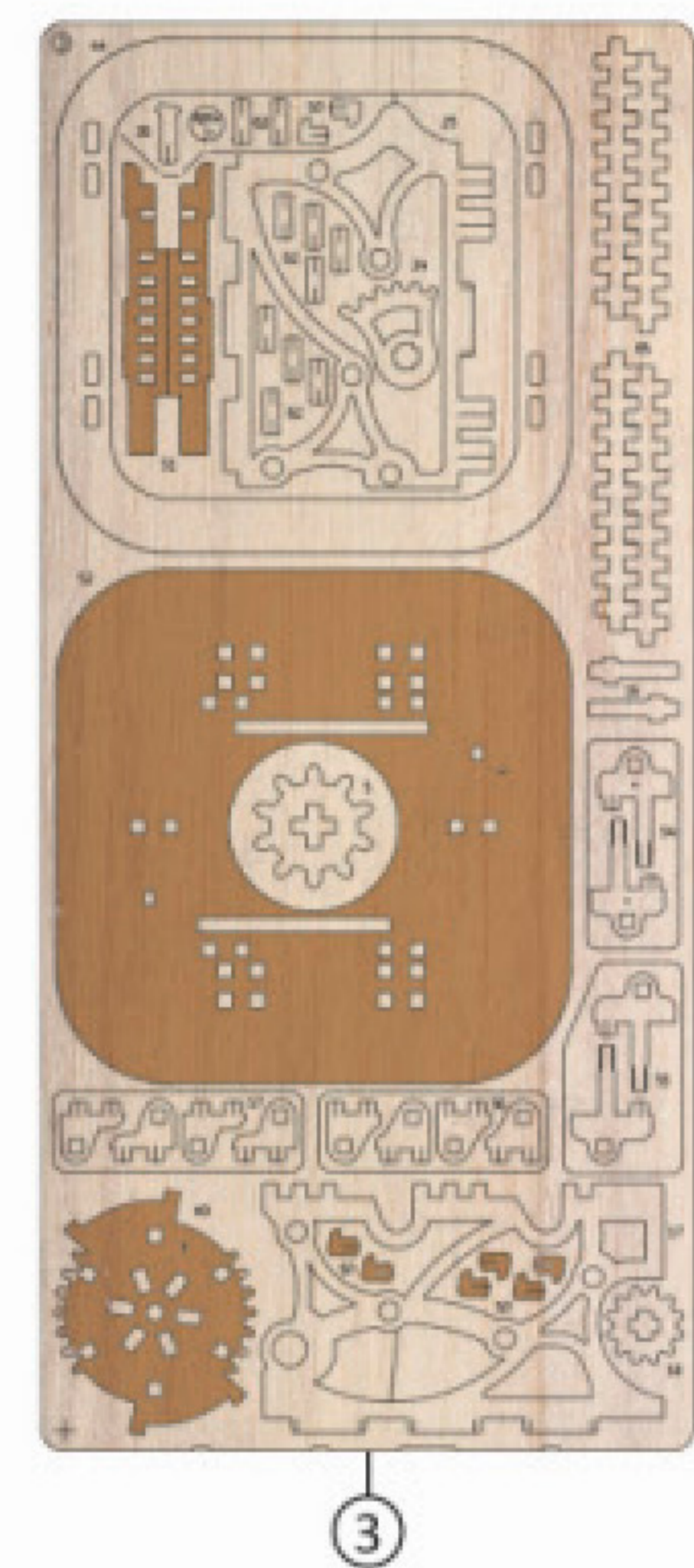

1

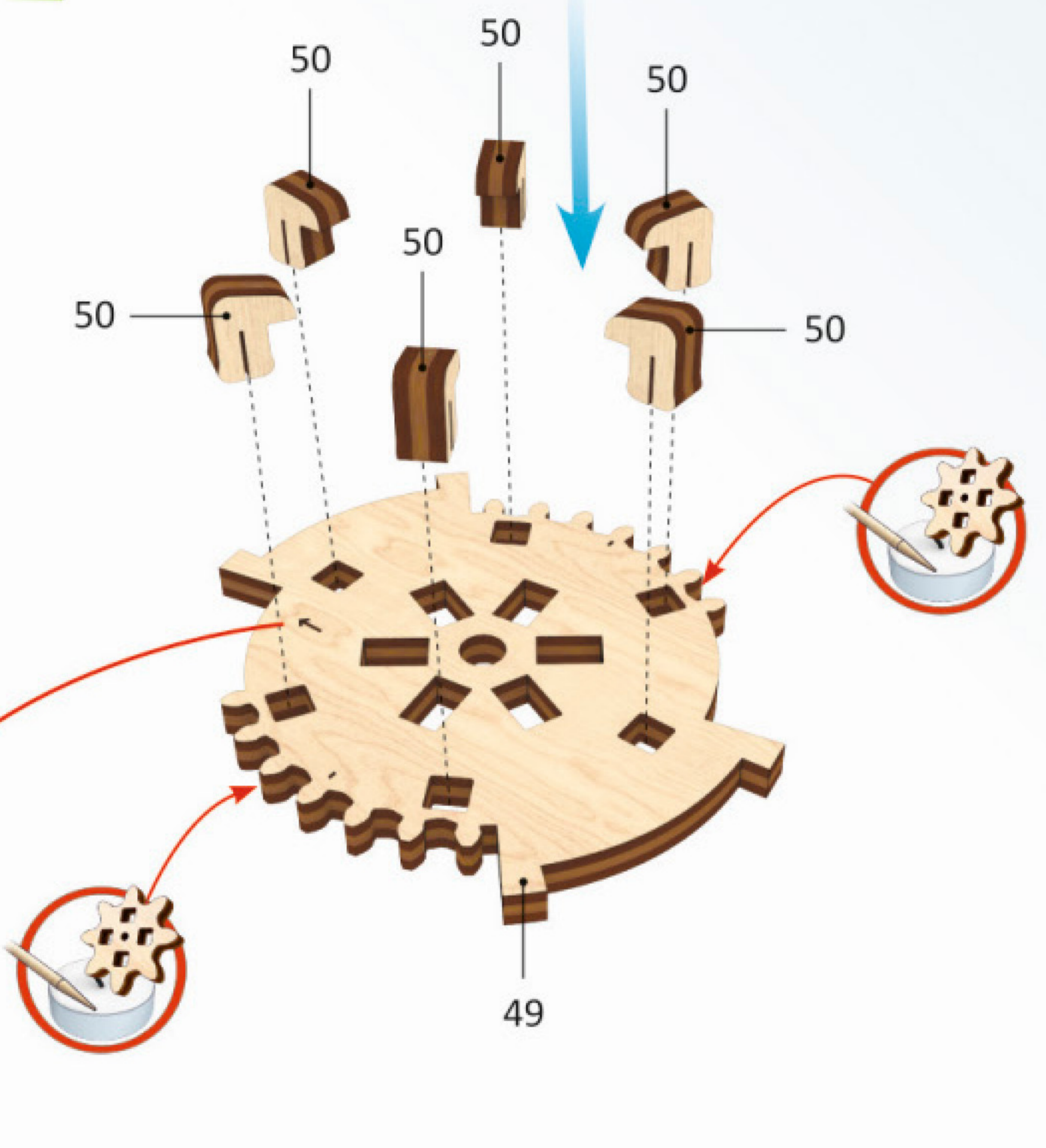

2

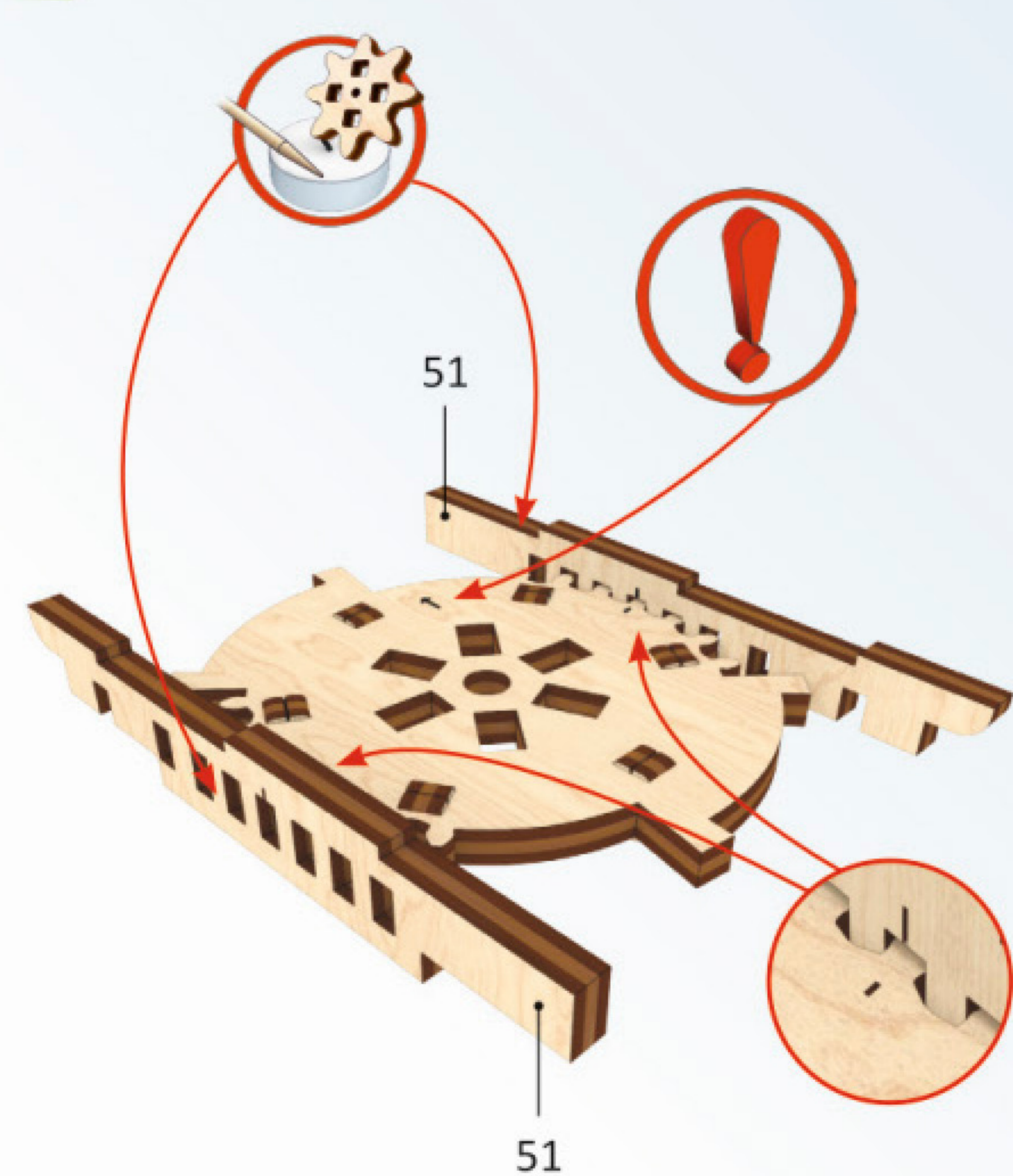

3

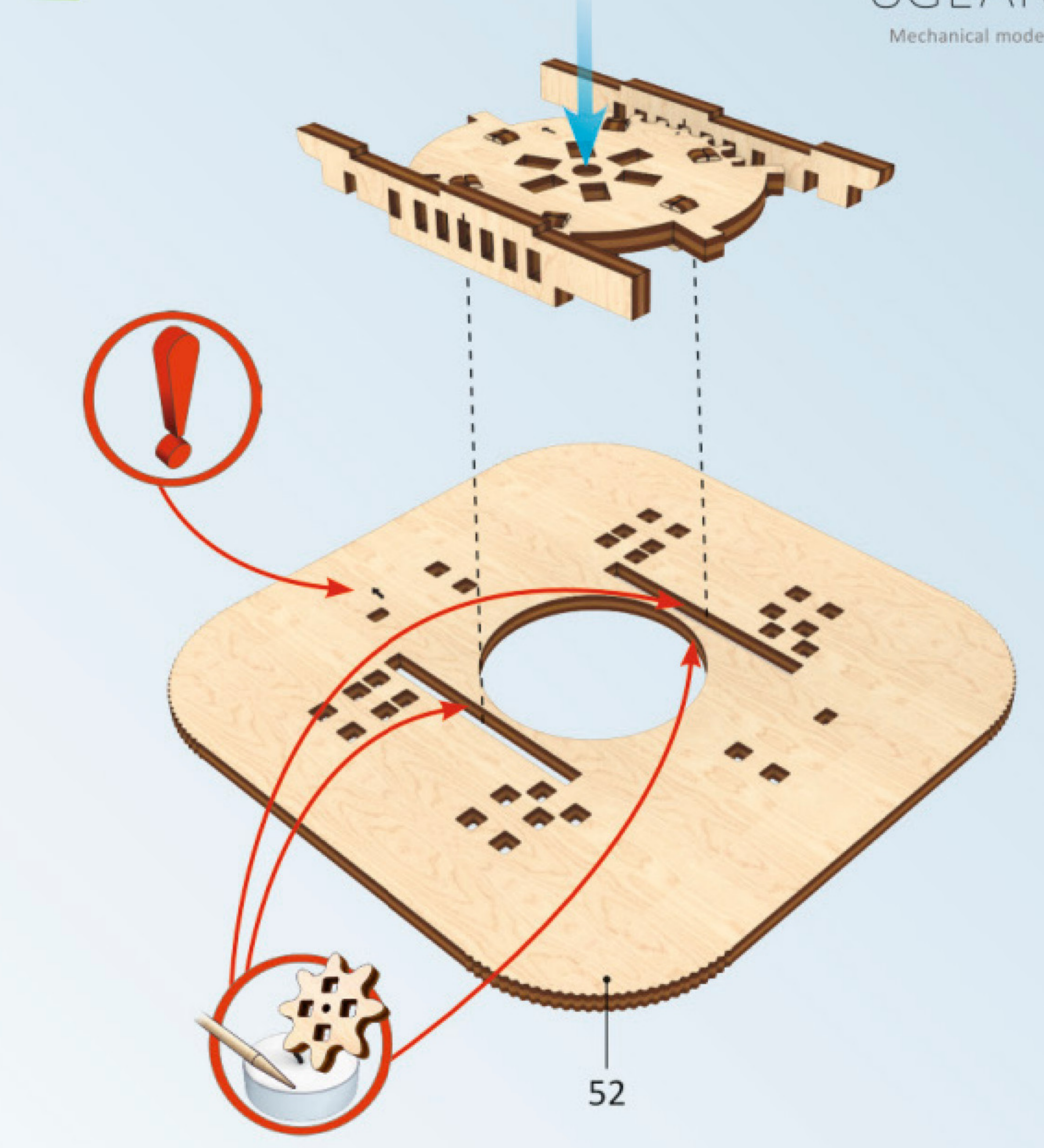

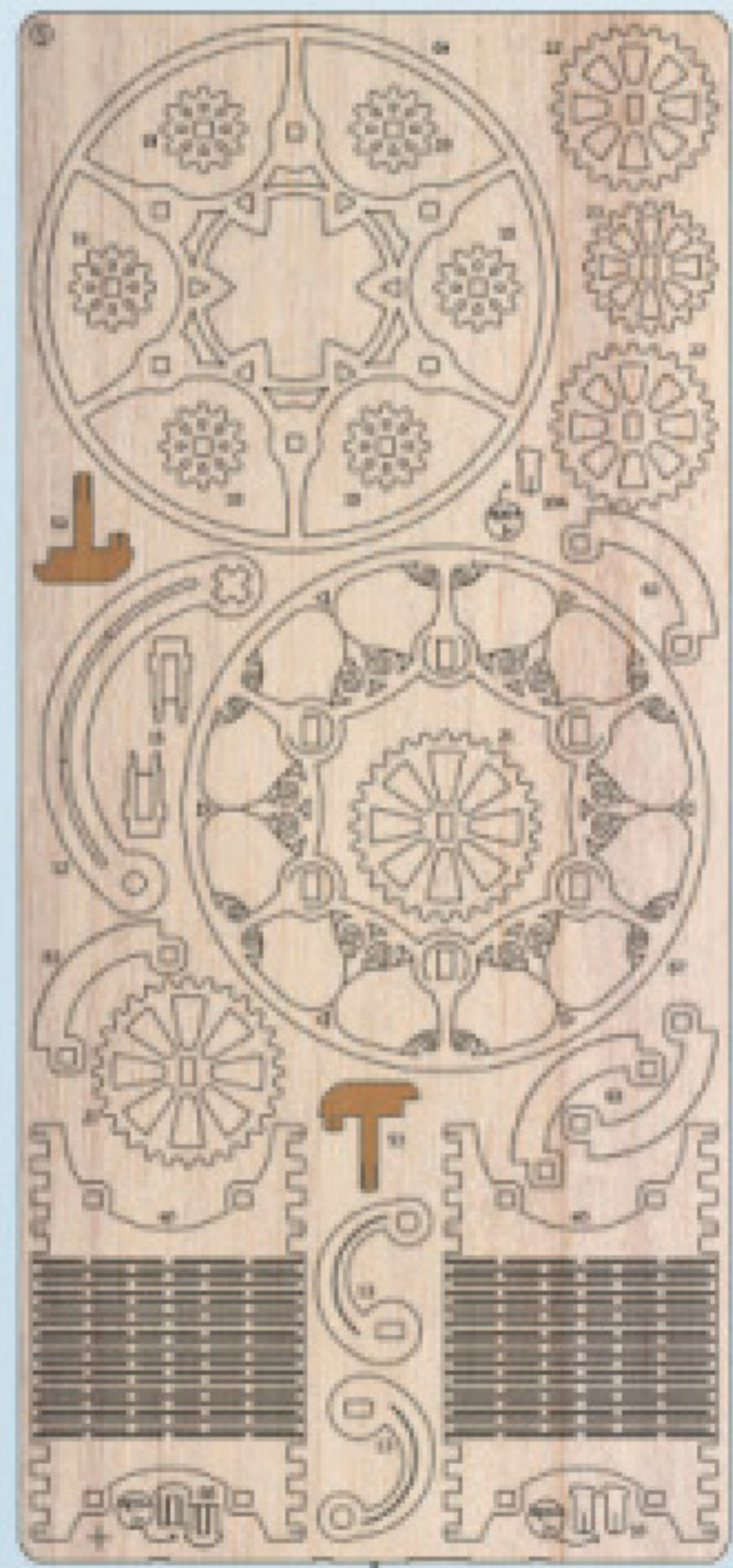
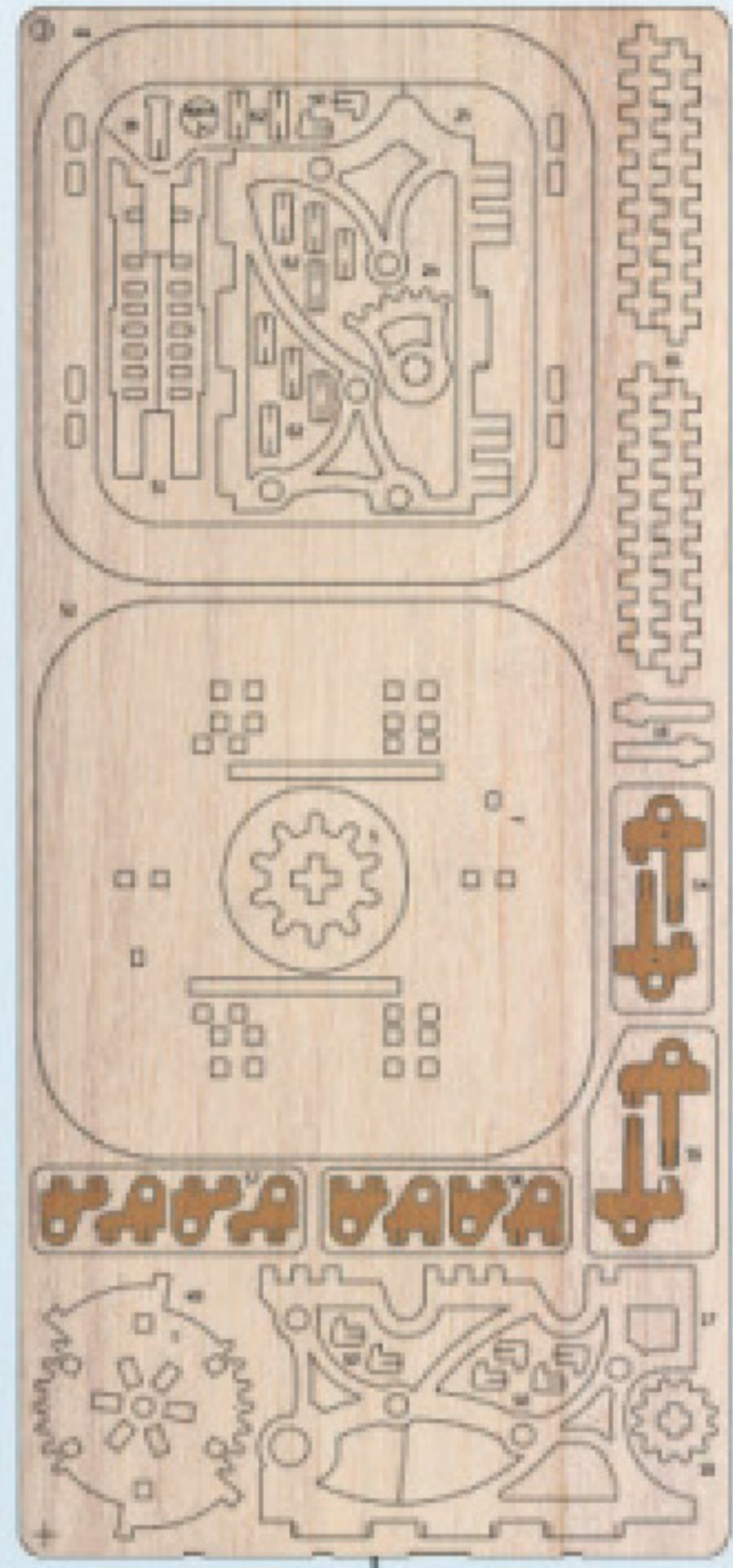

1

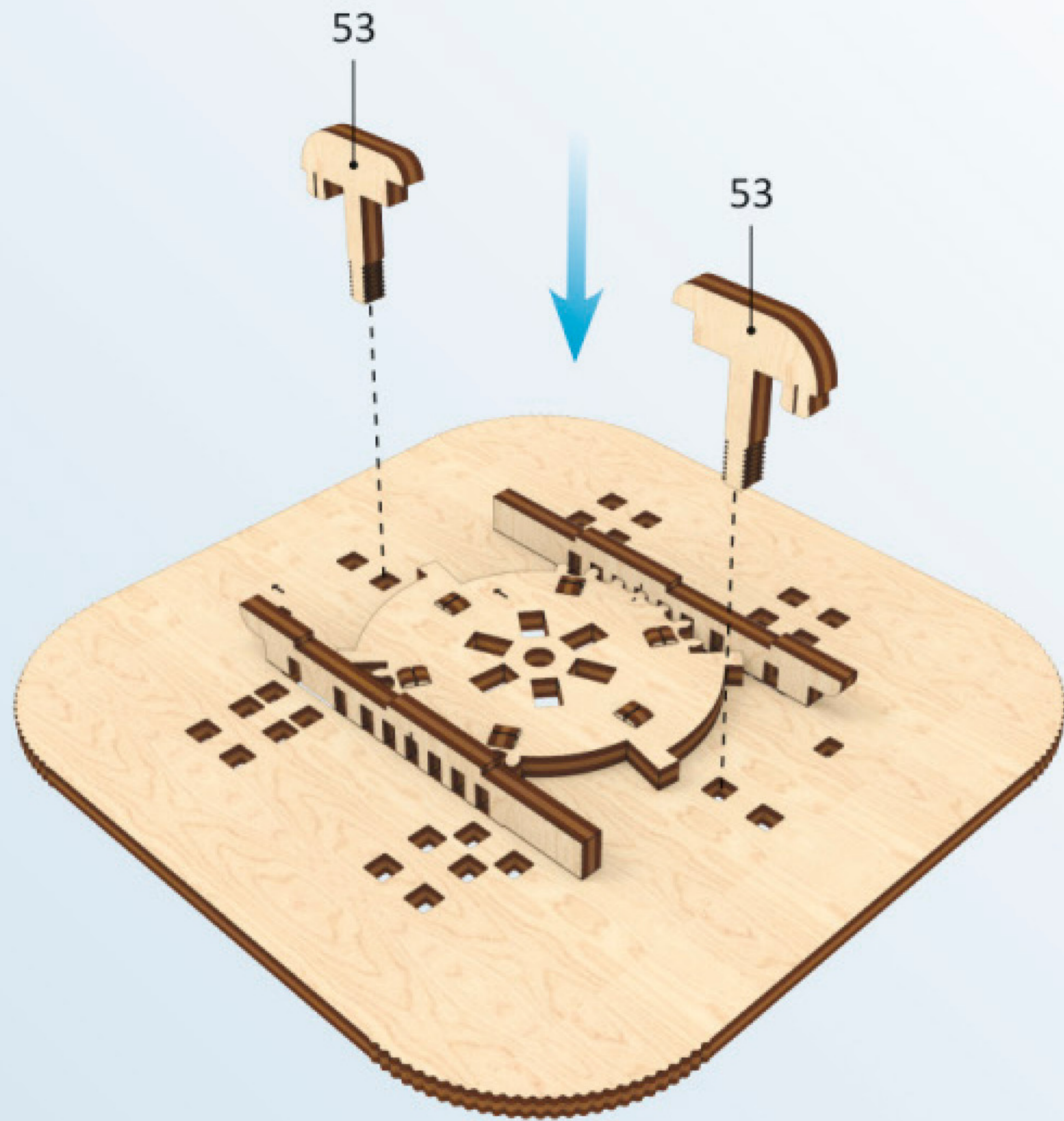

2

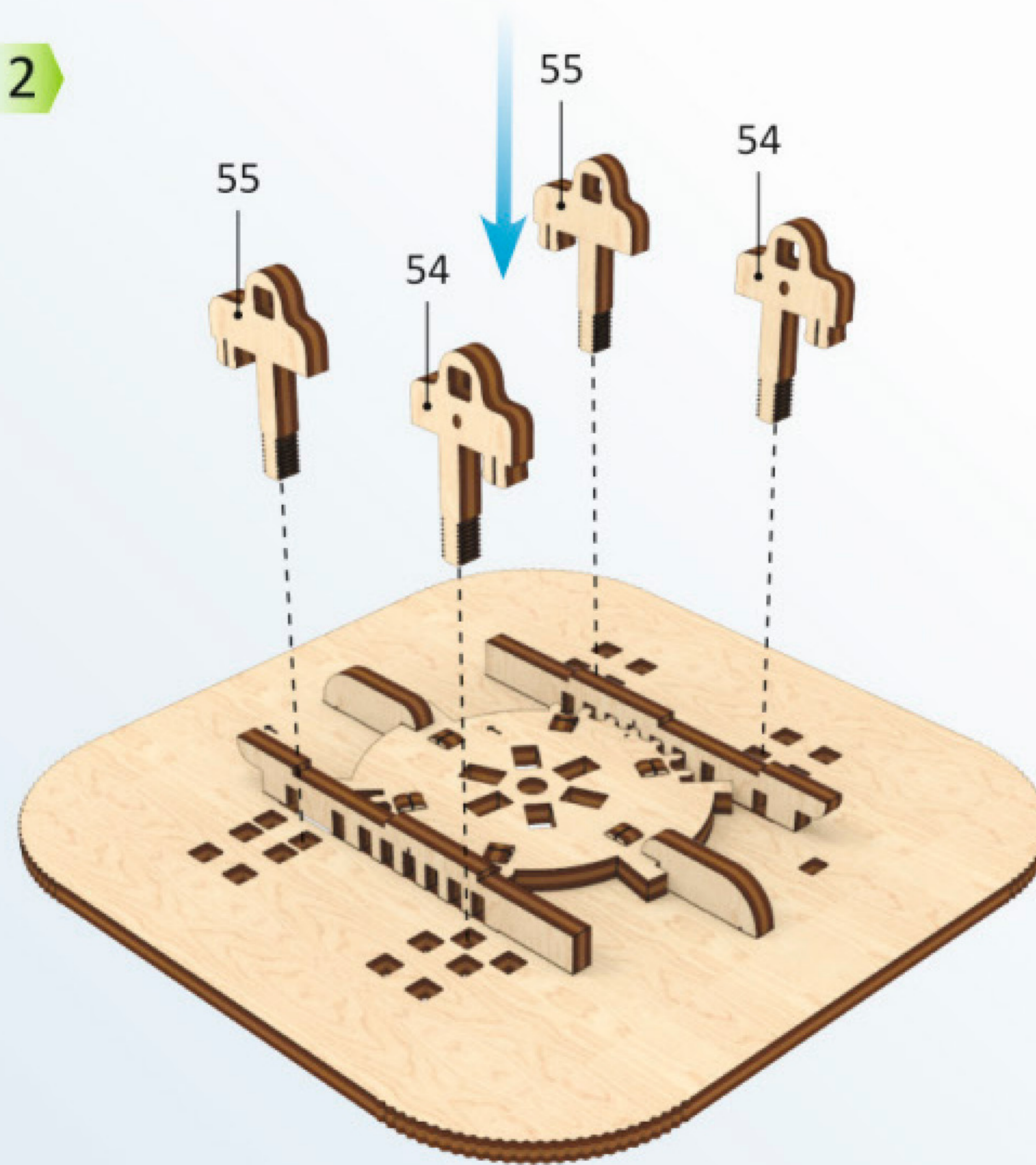

3

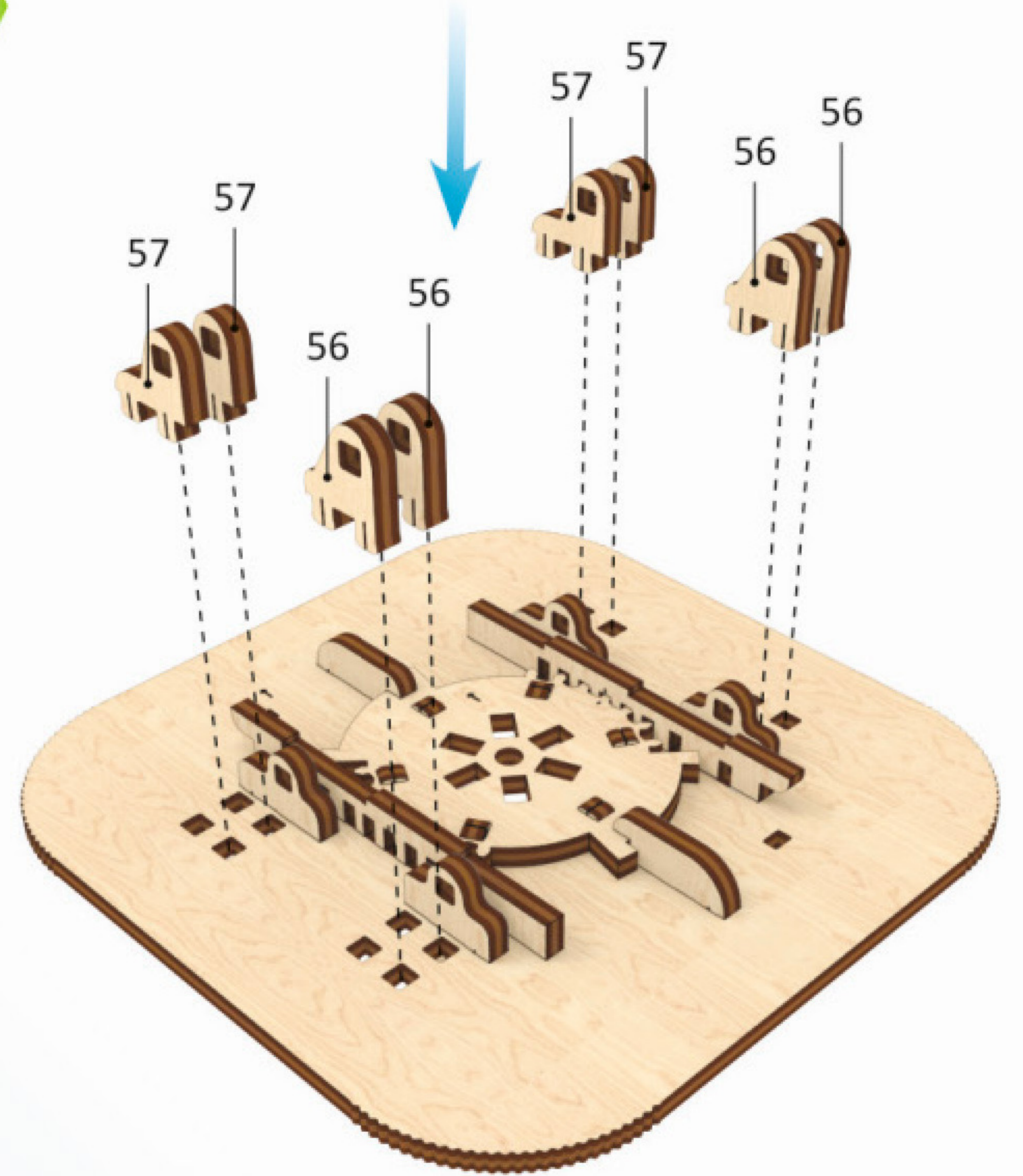



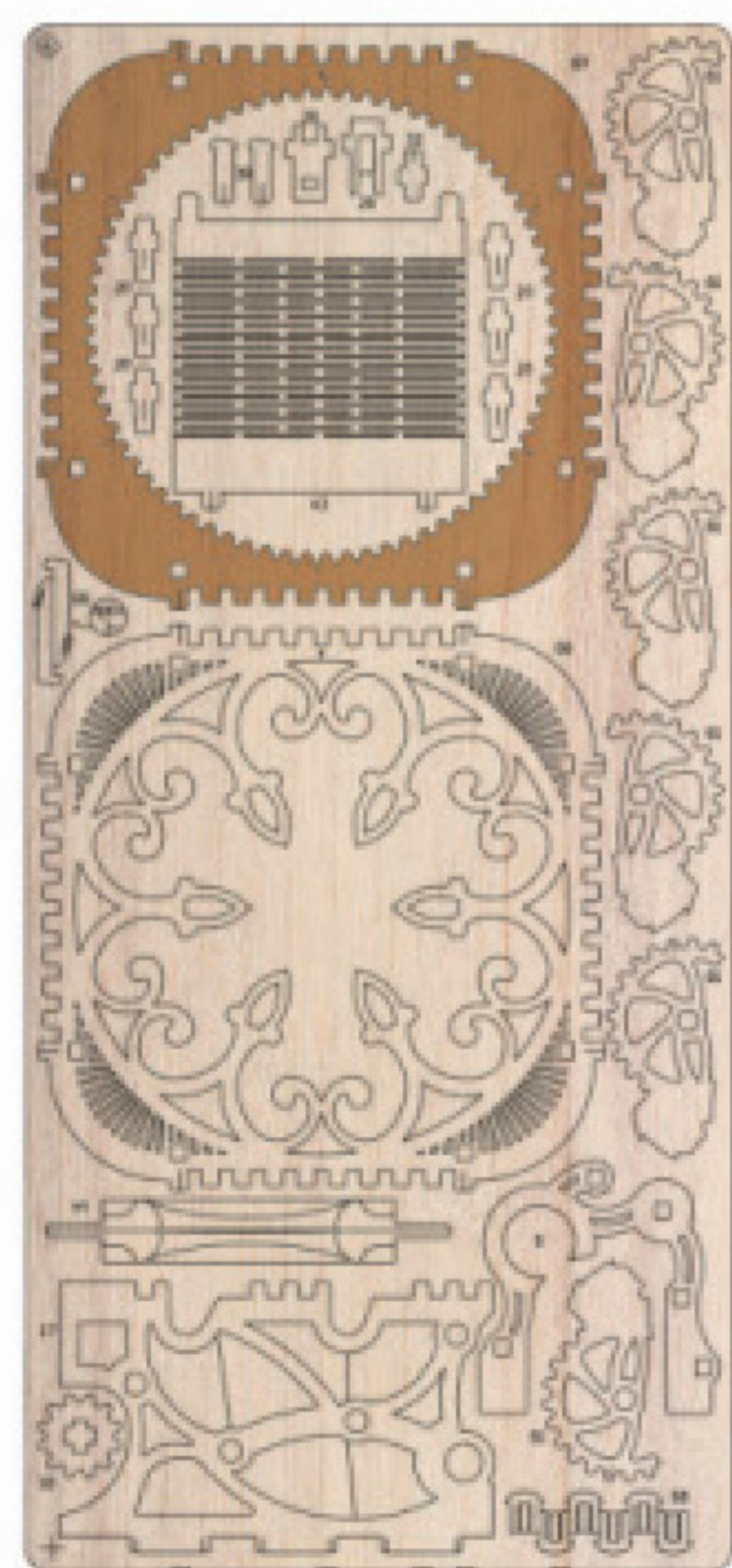
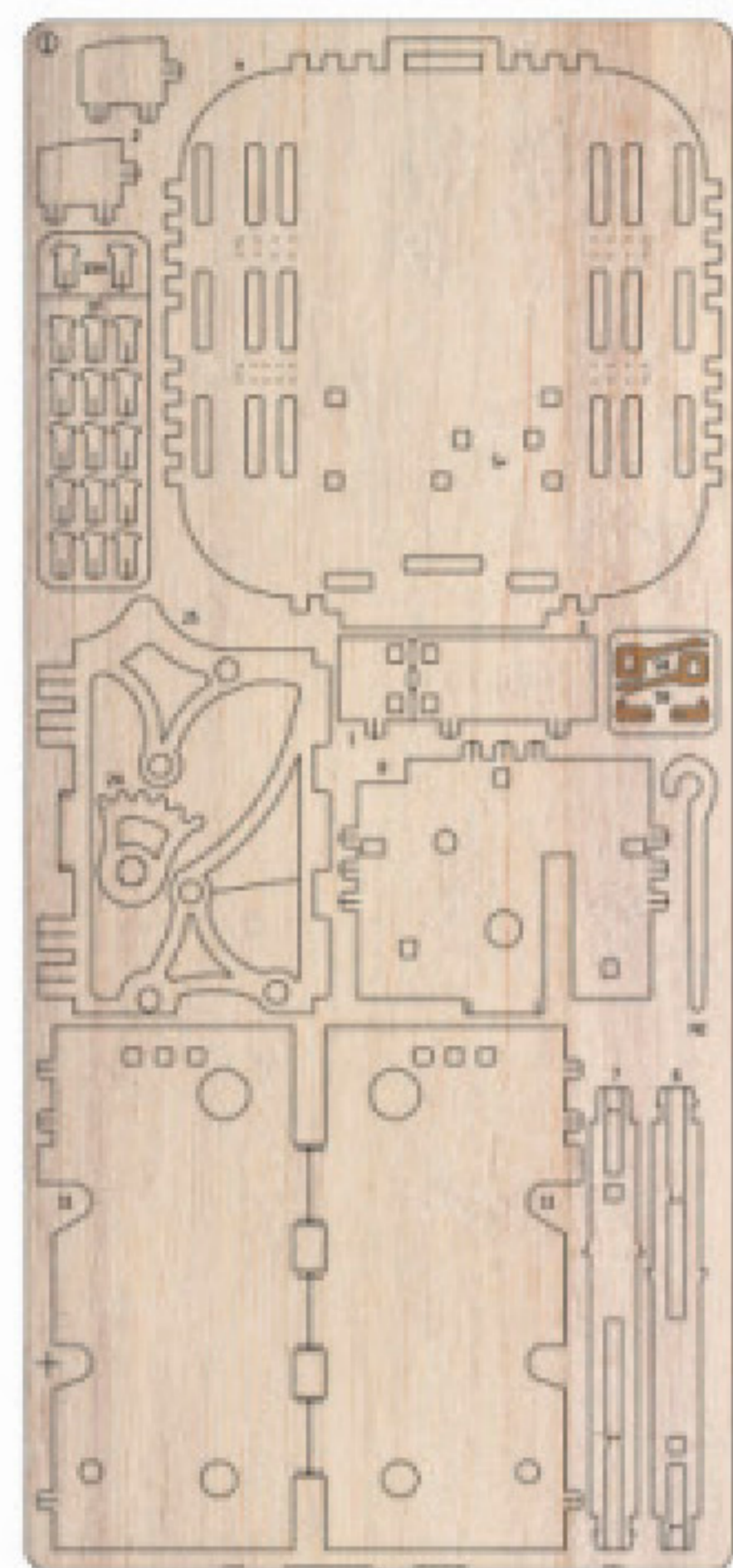

1

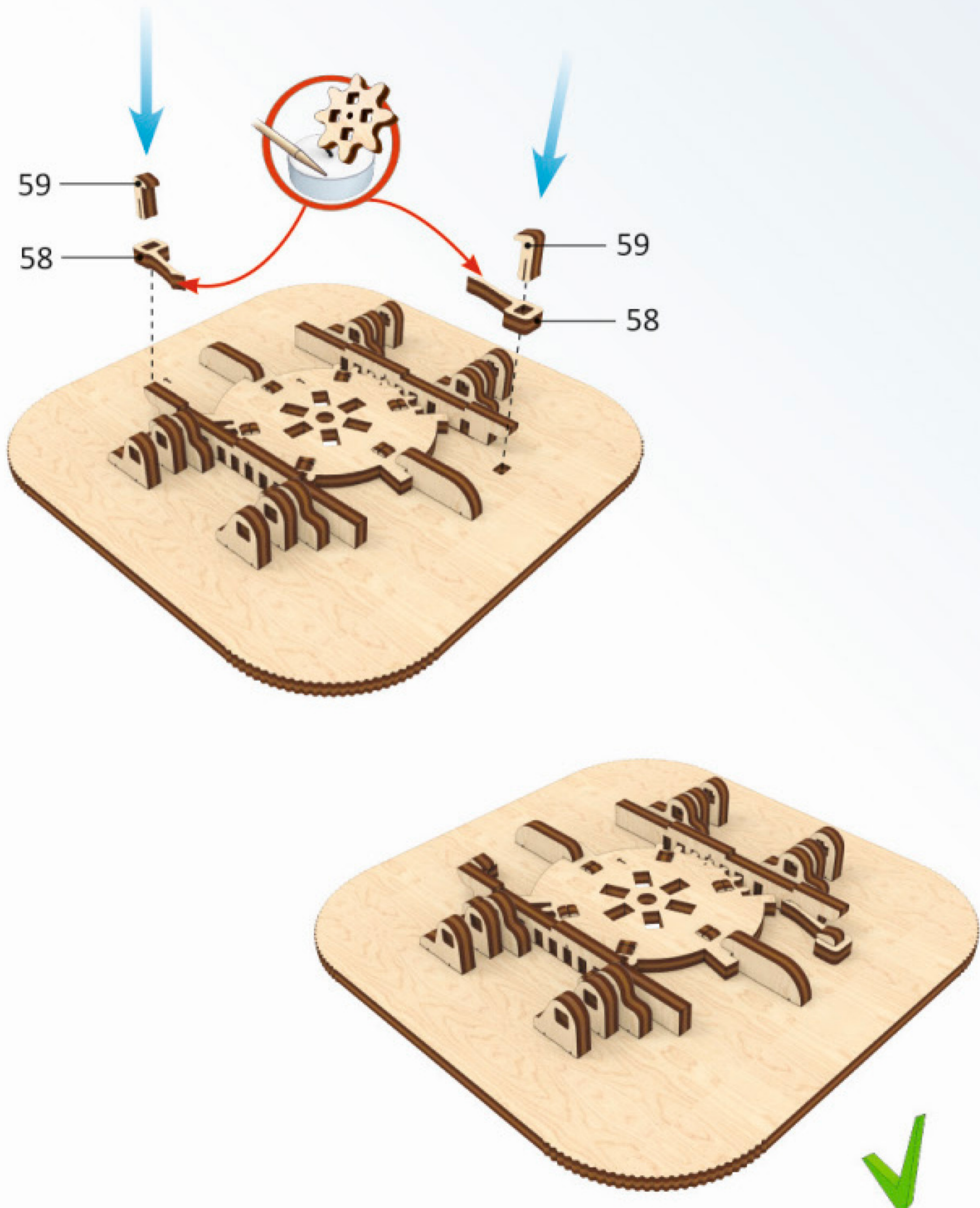

2

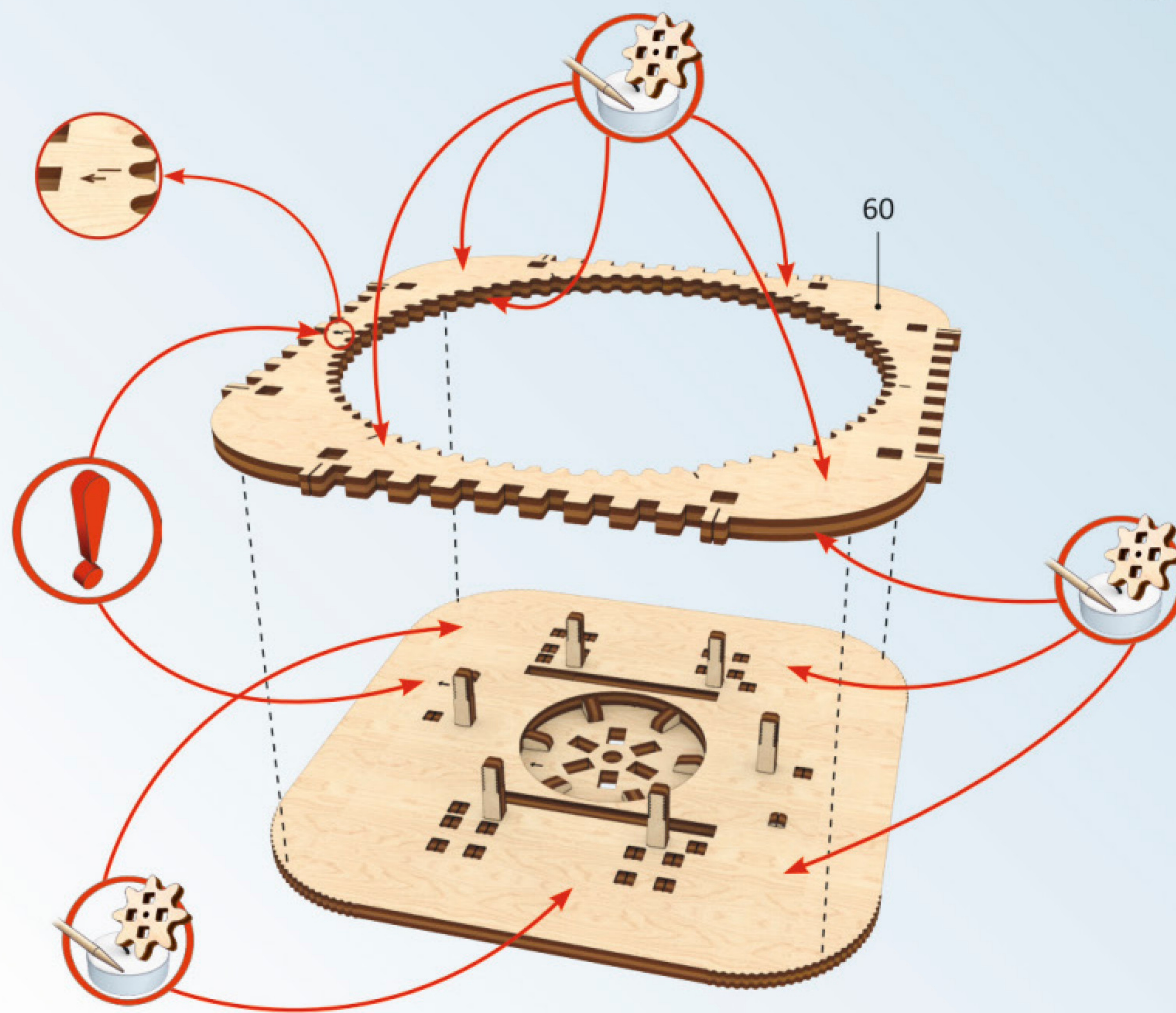

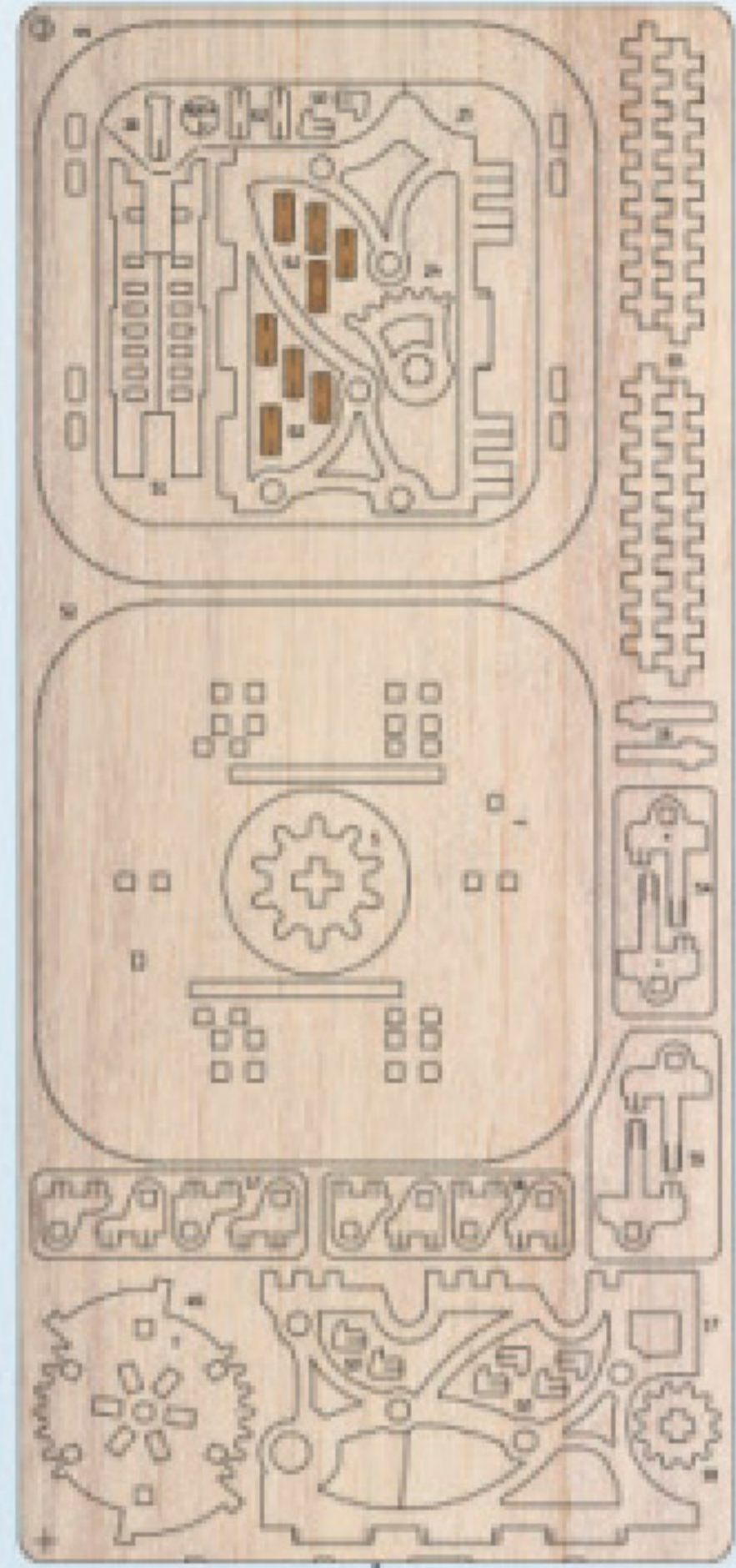

1

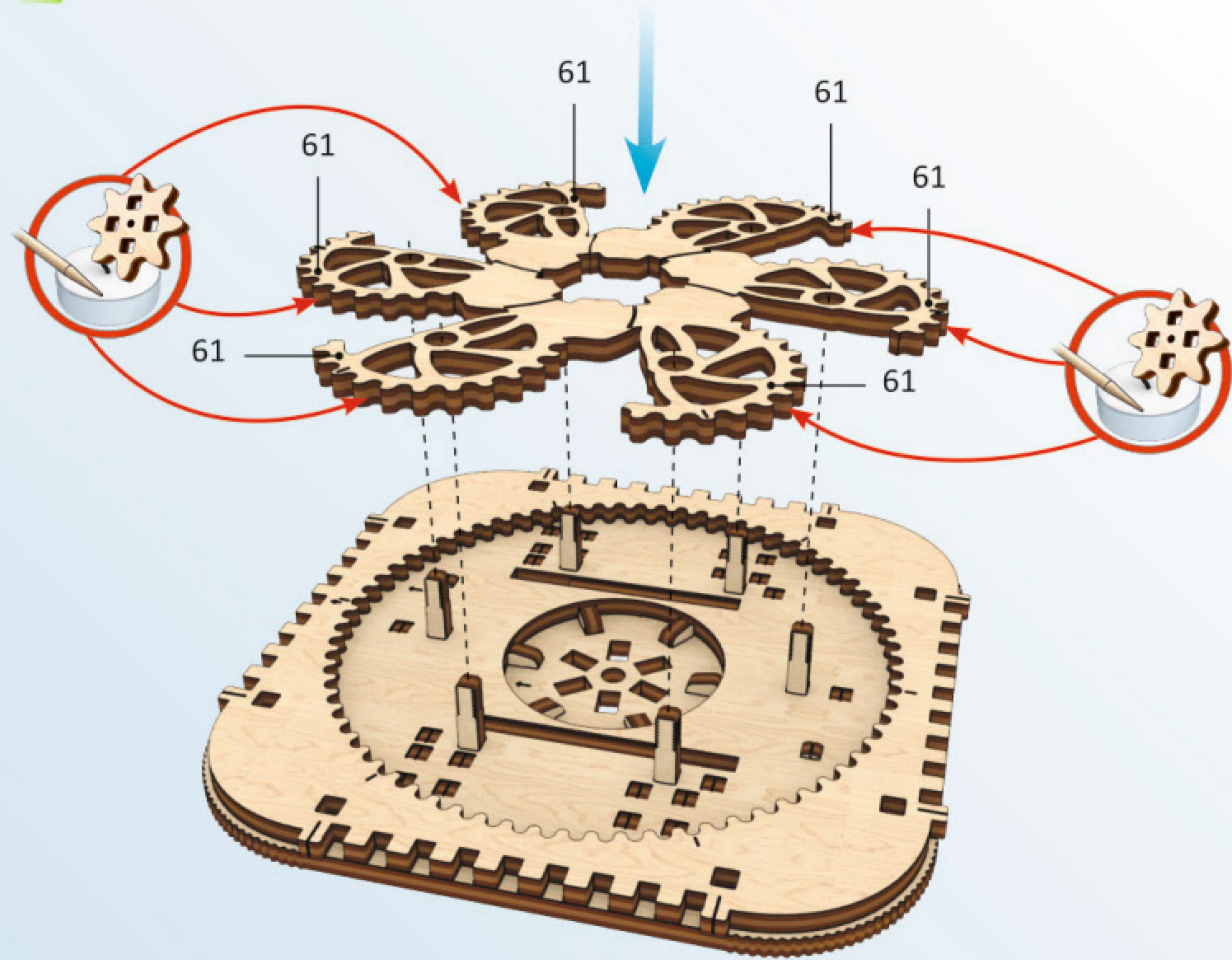

2

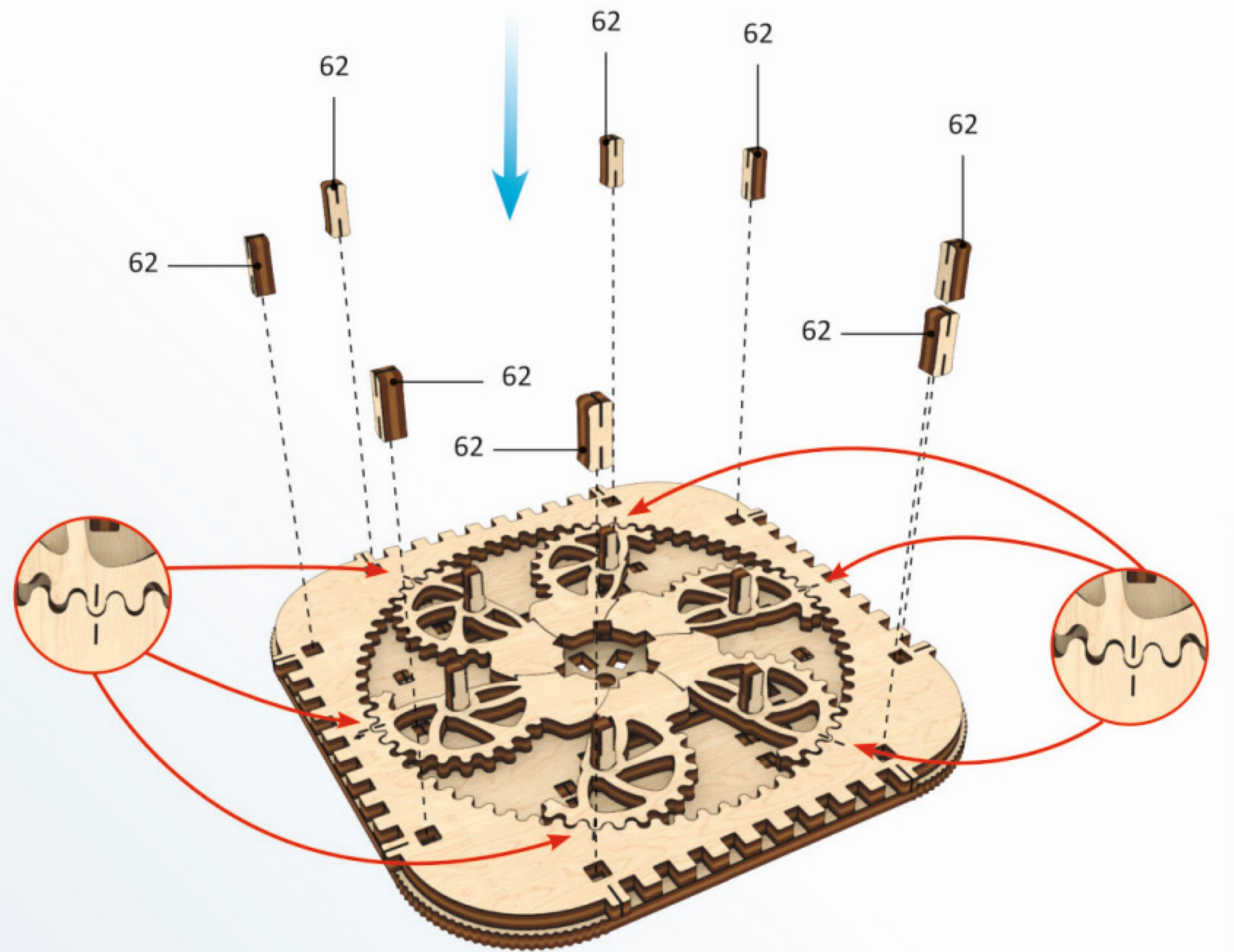

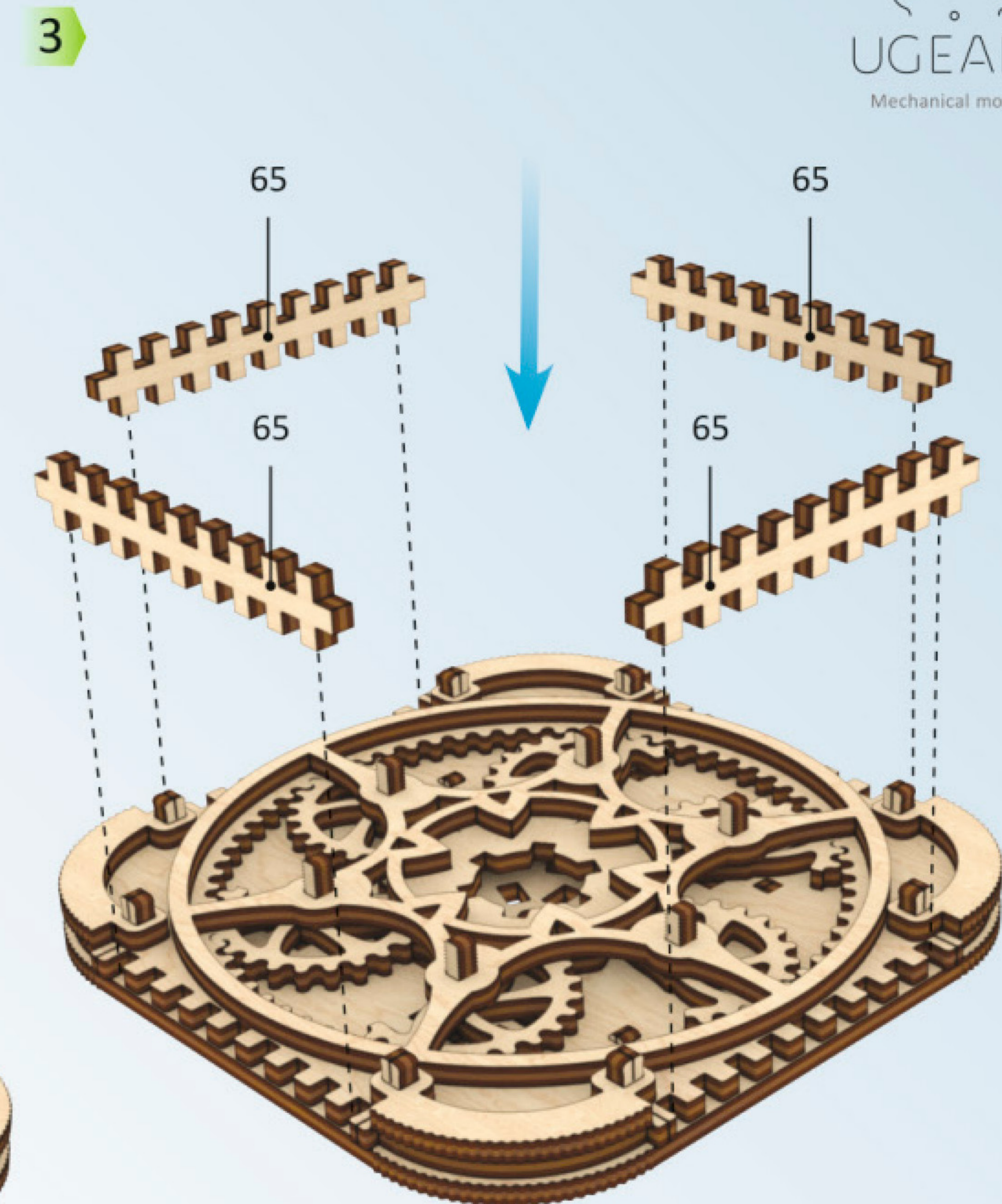
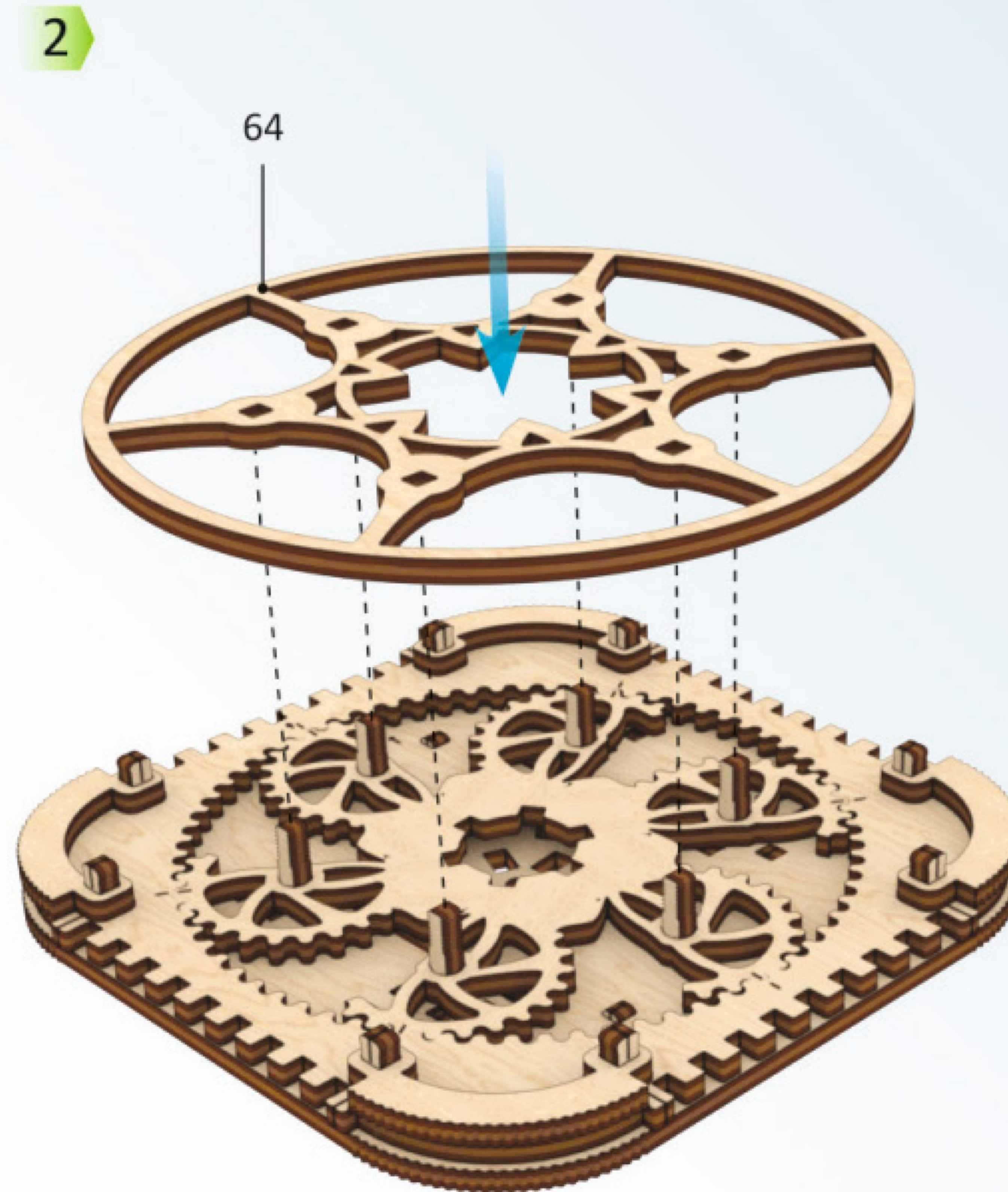
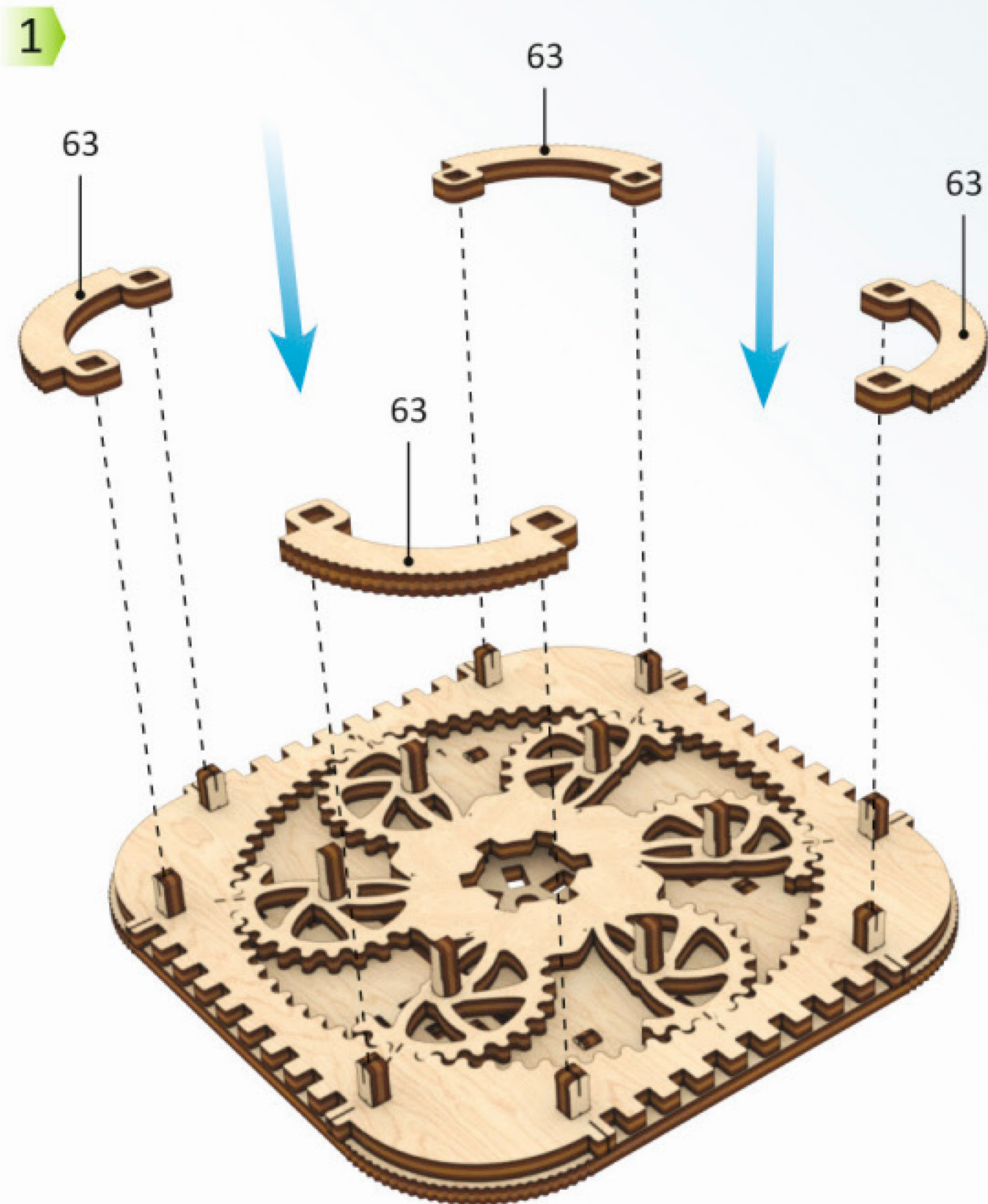
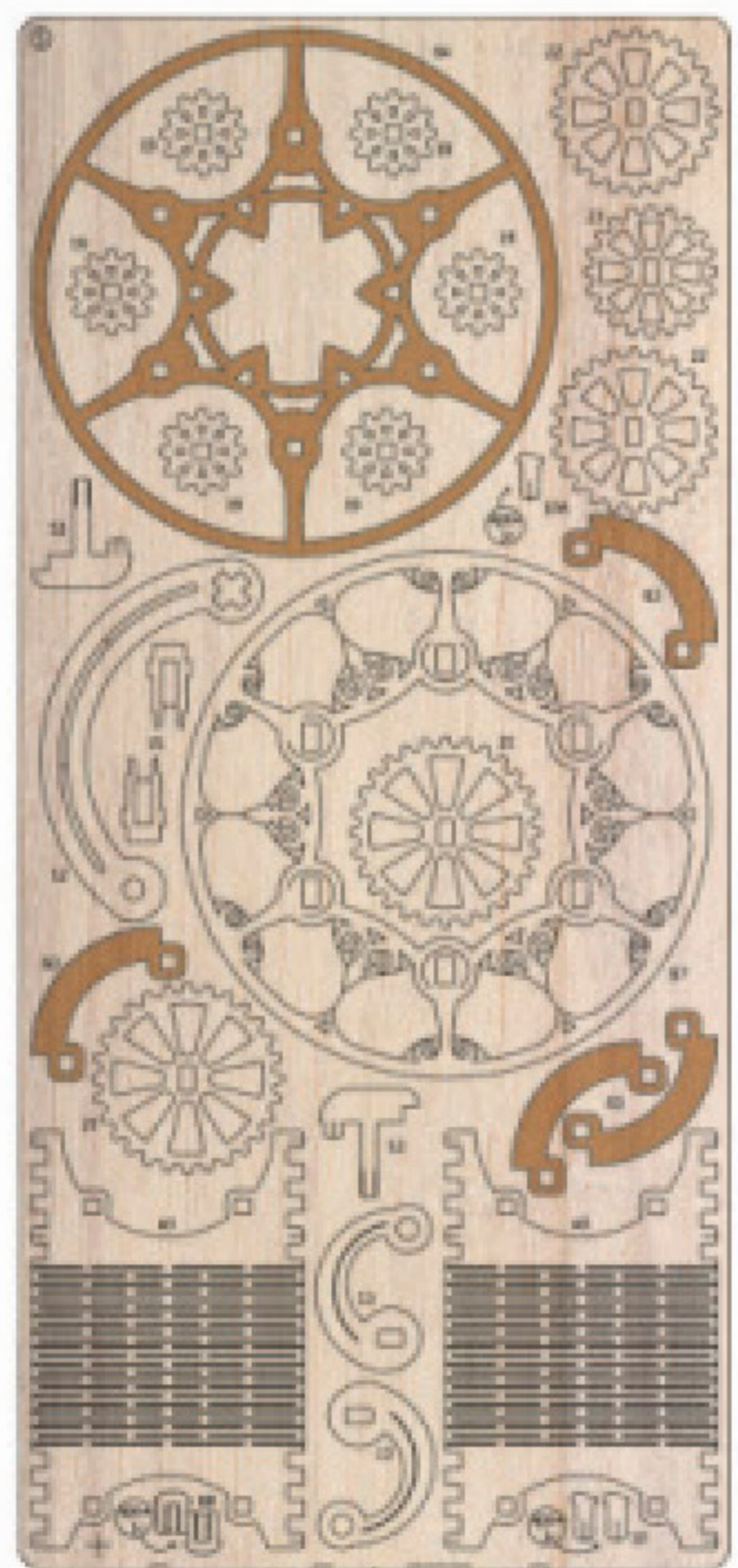
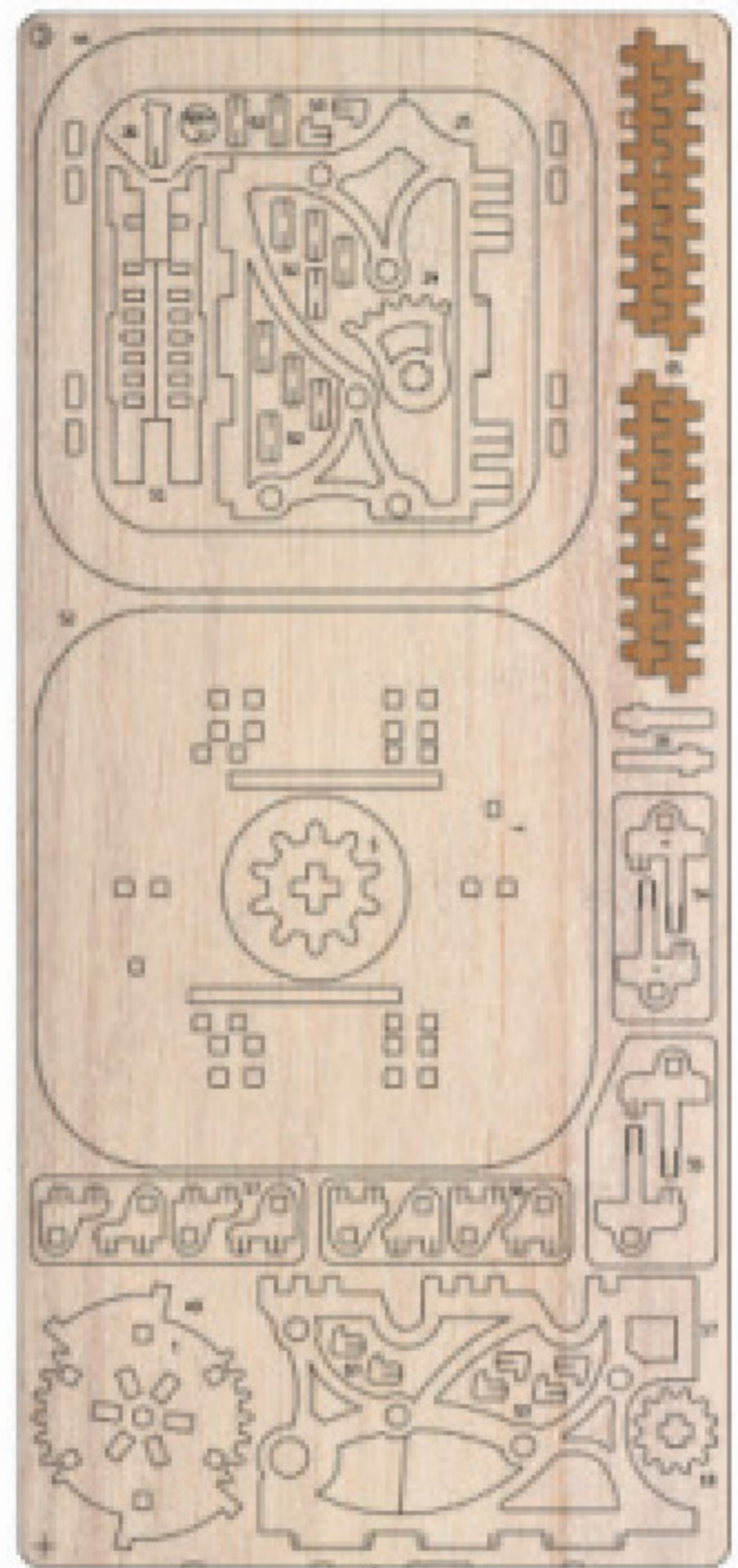

Mechanical models

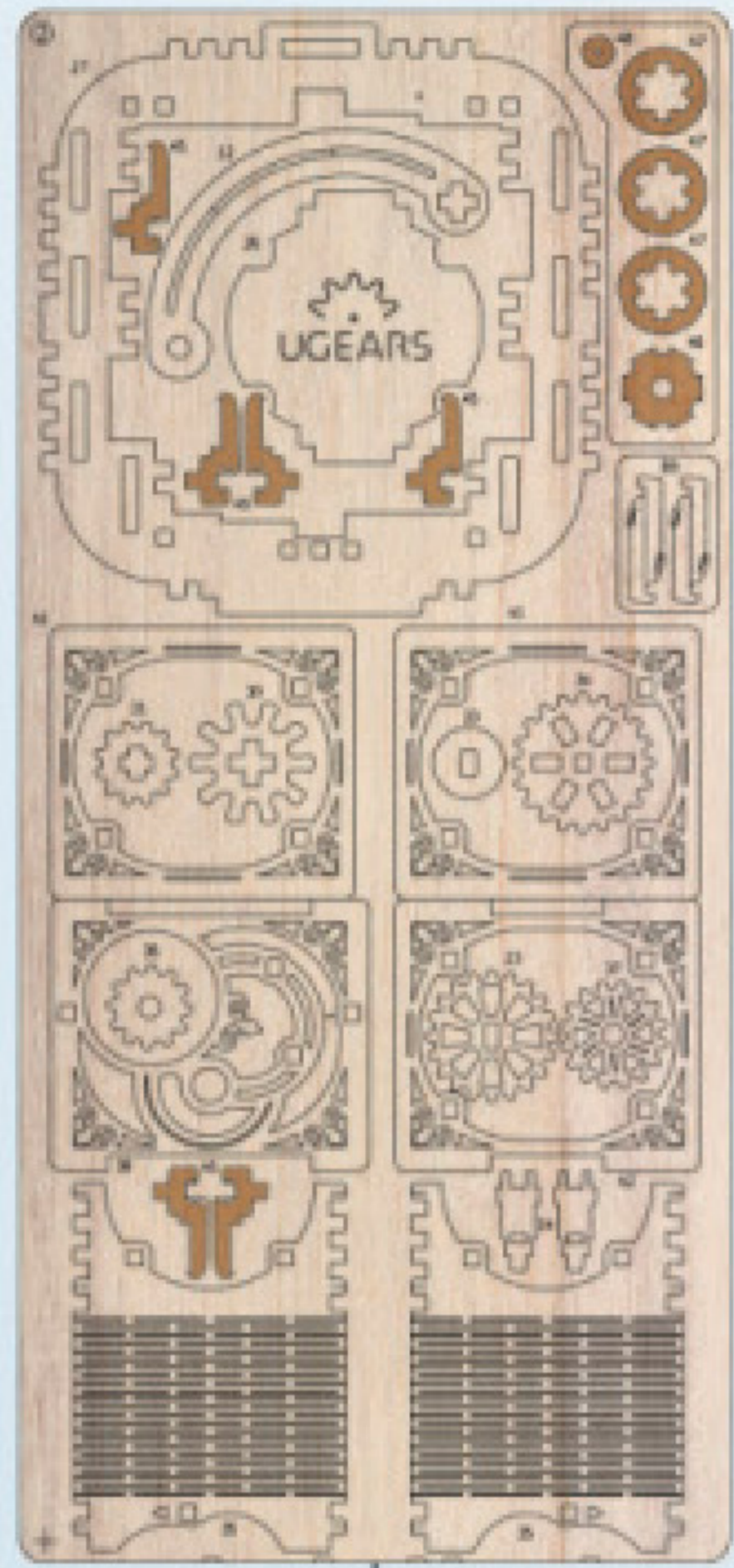

1

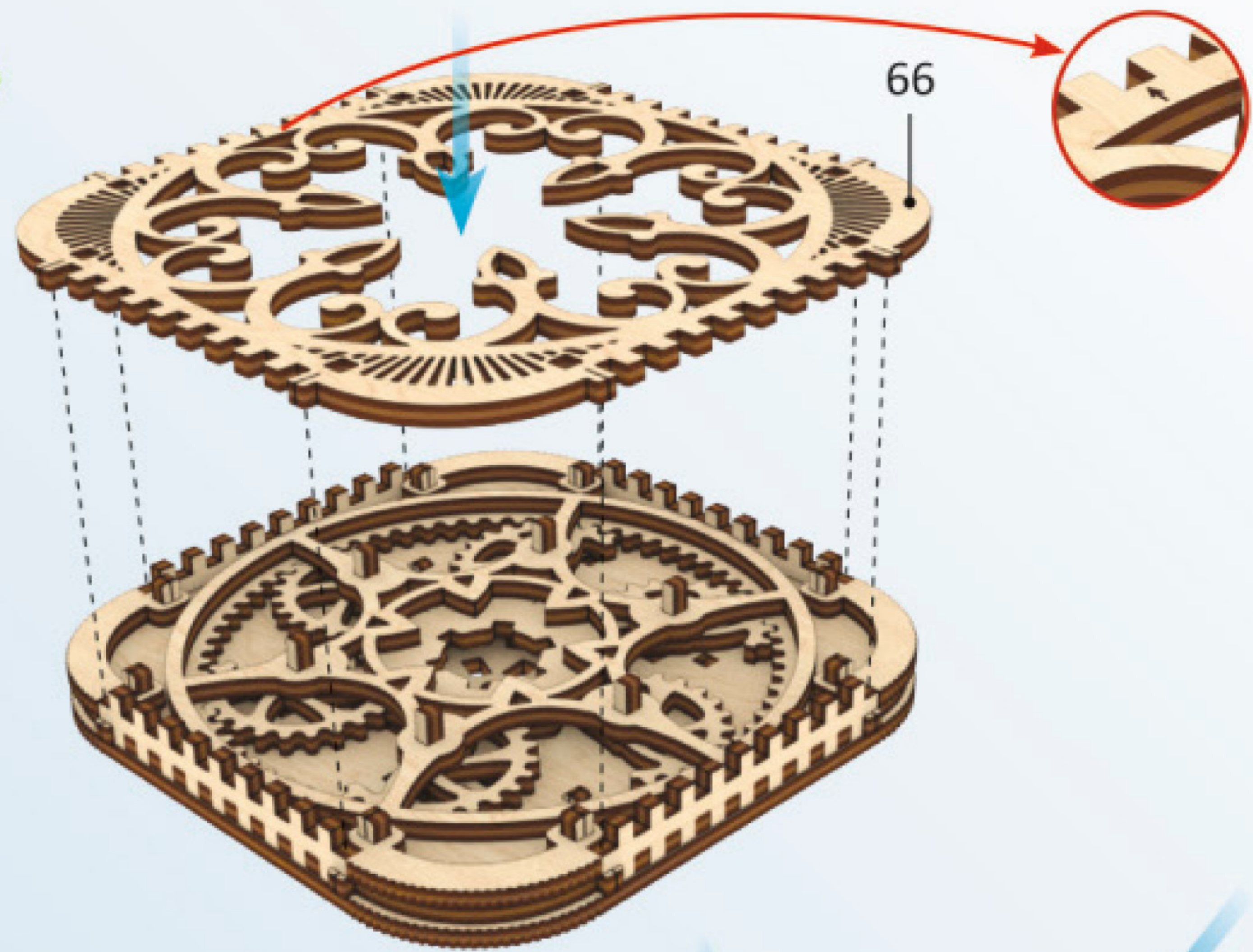

2

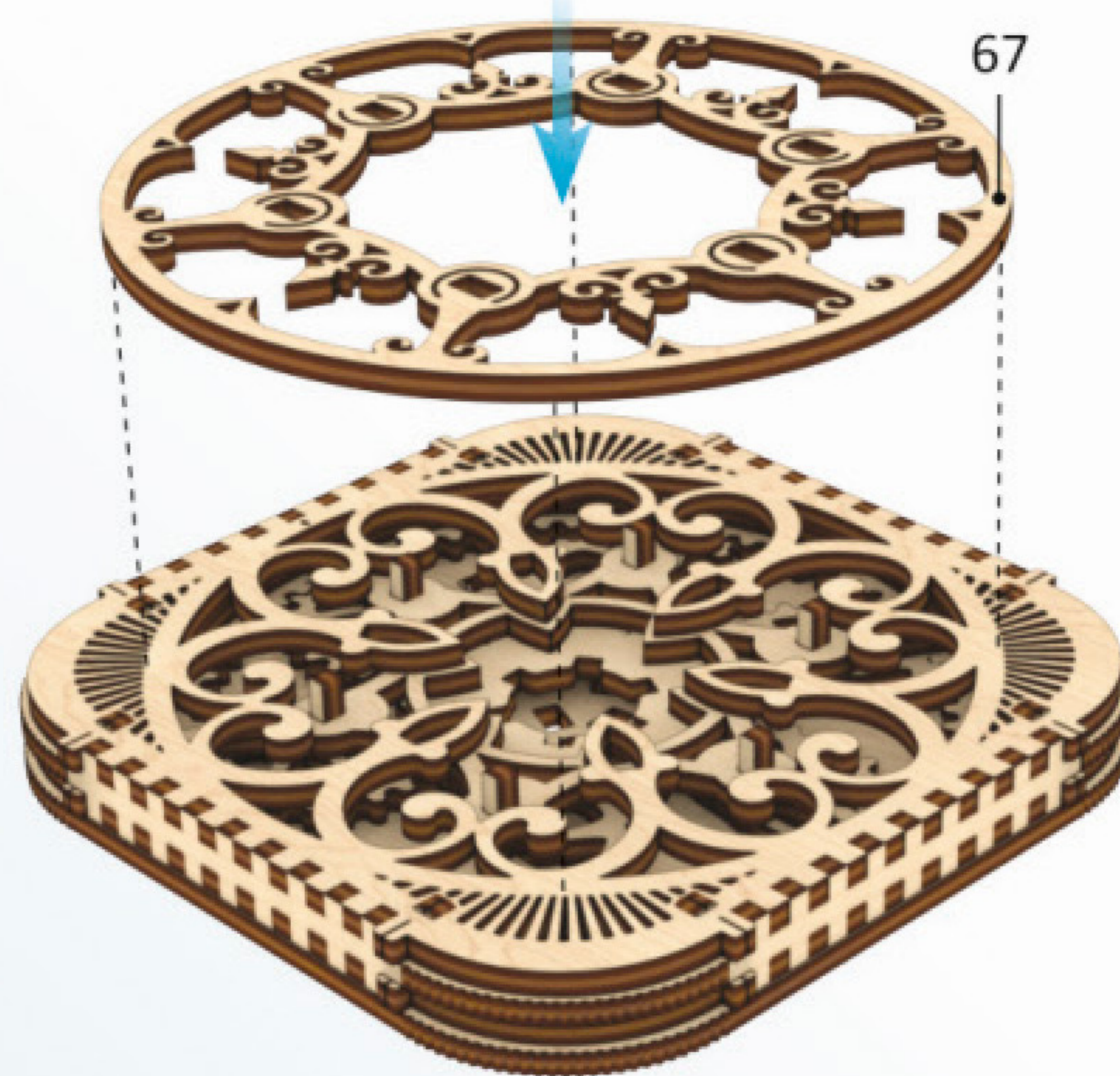

3

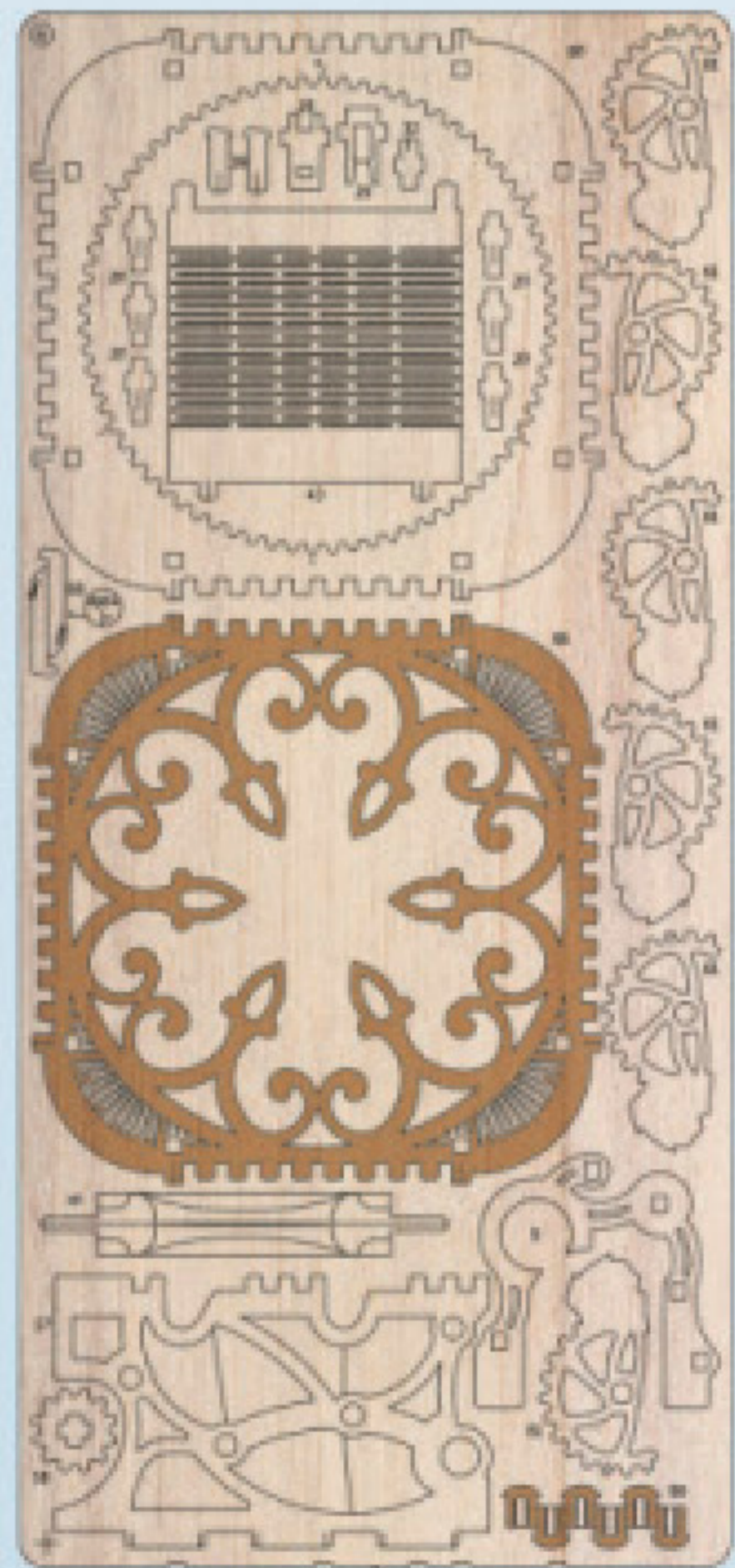
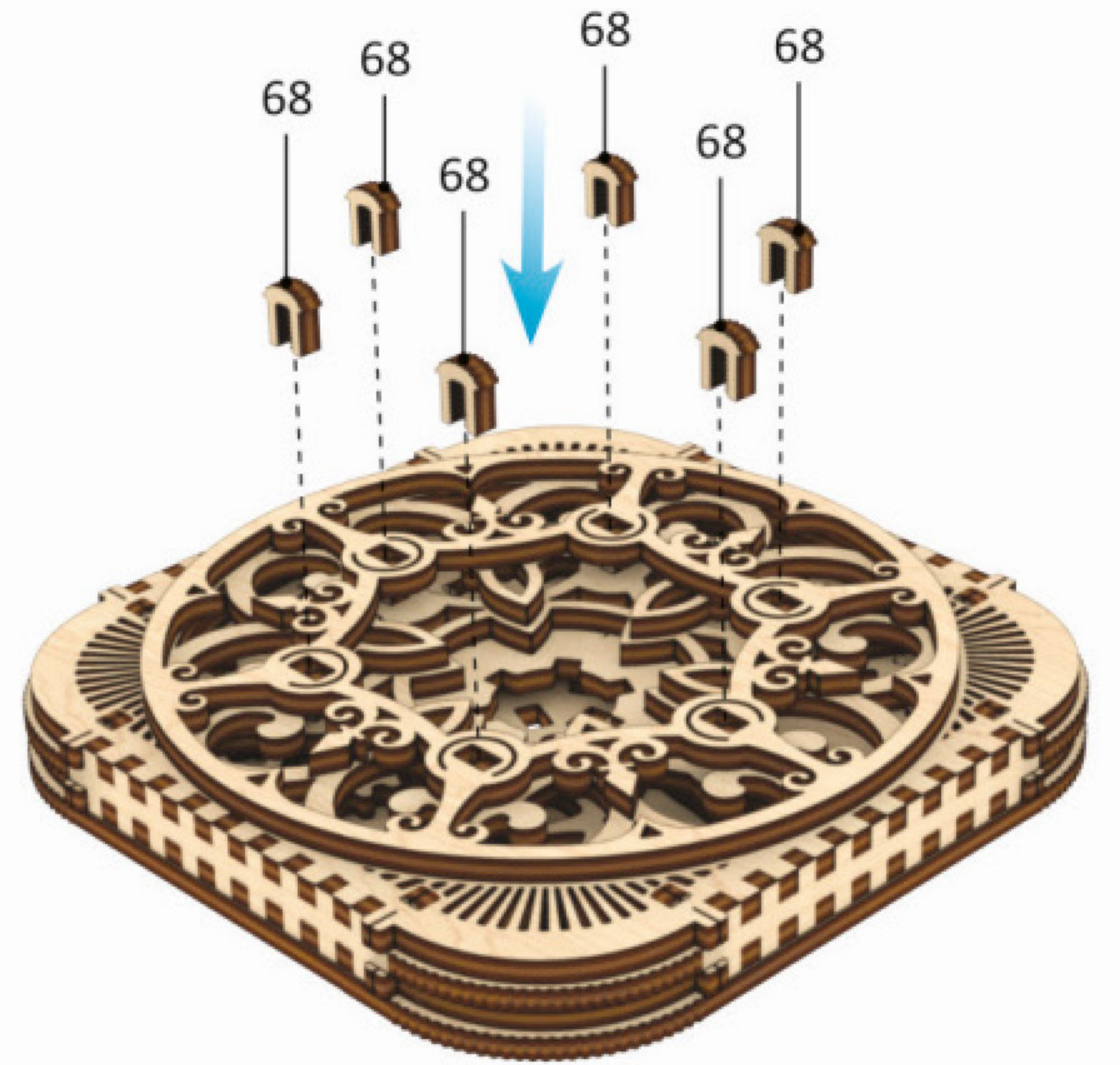

4

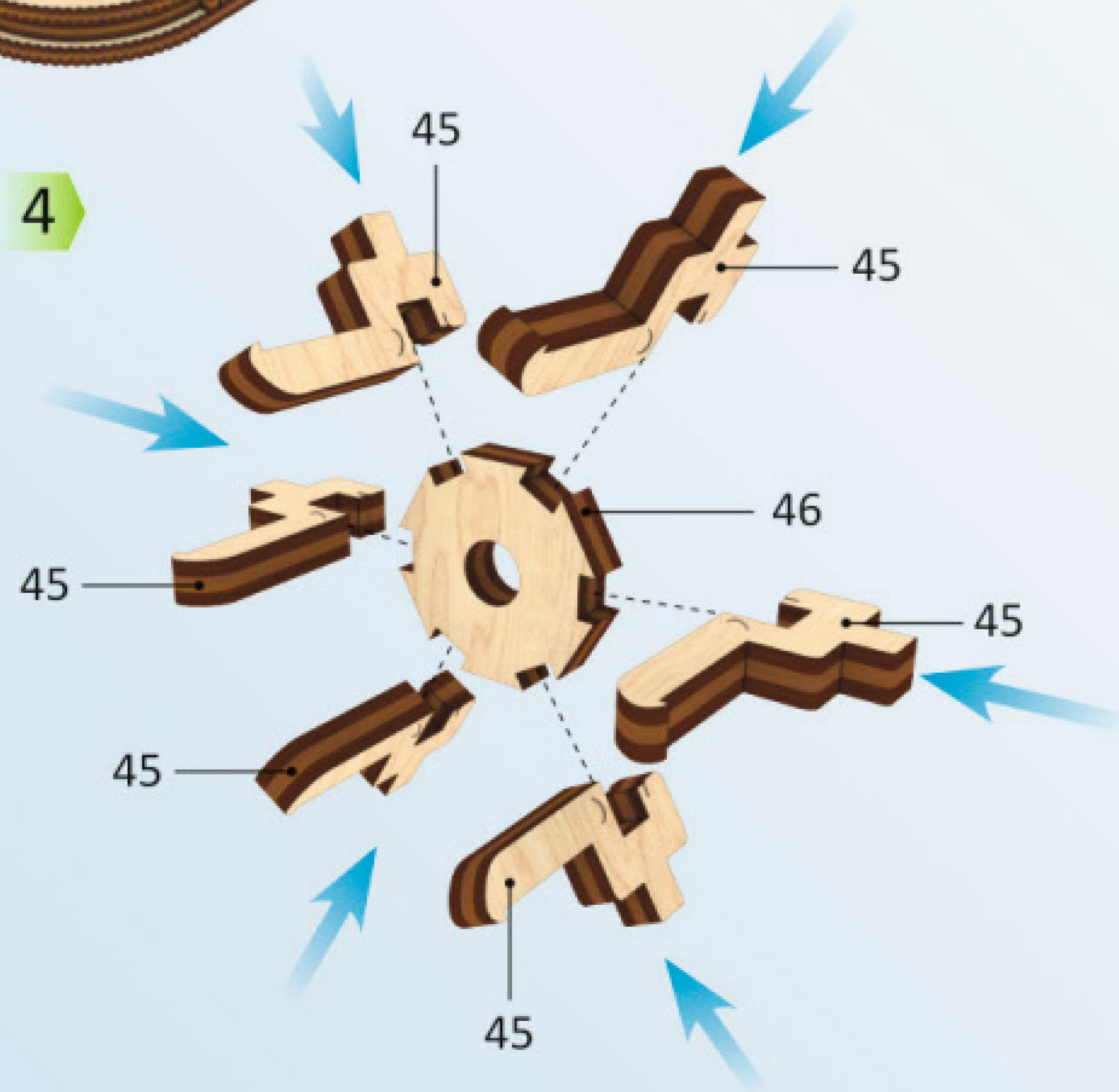

5

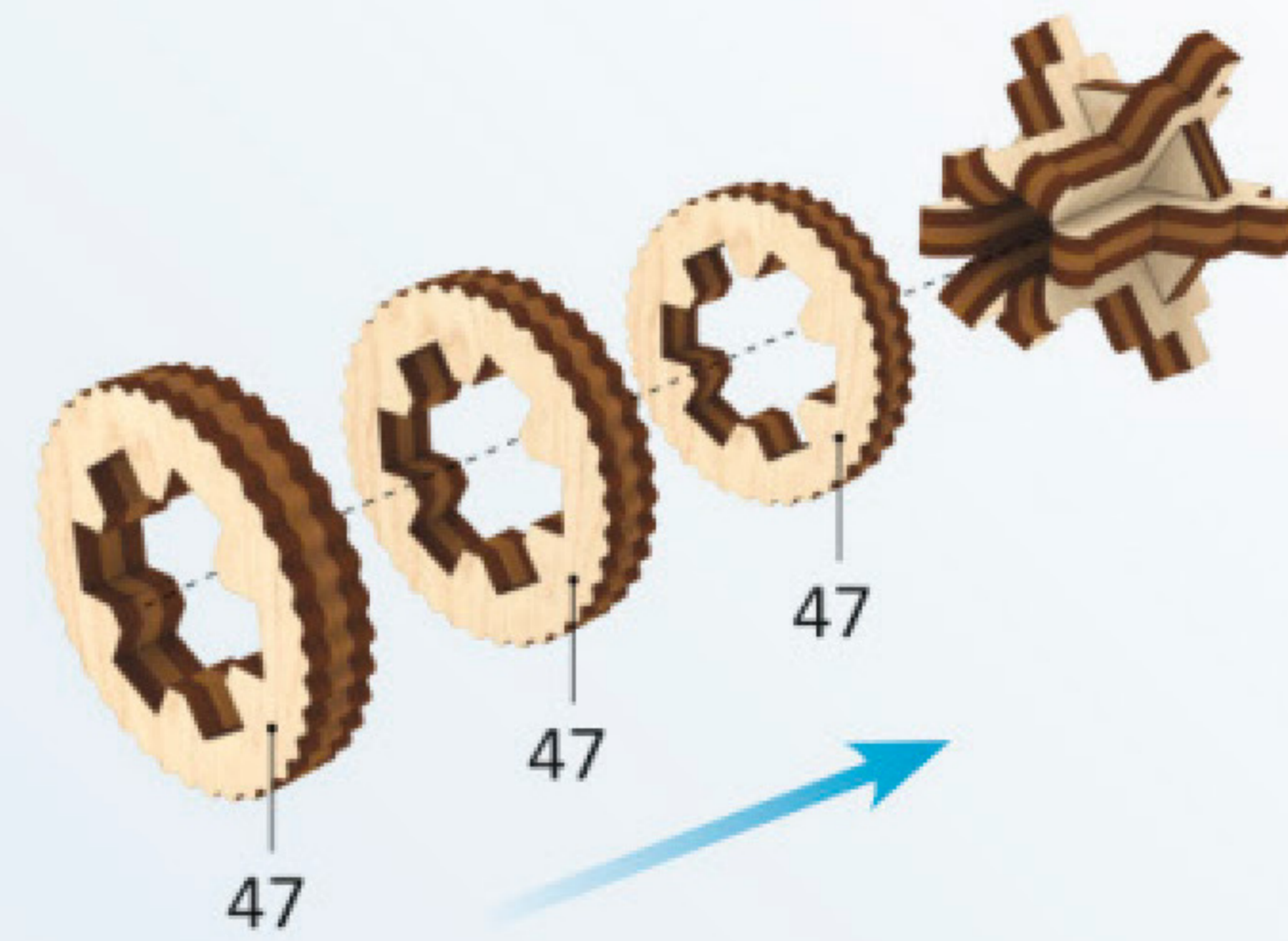

6

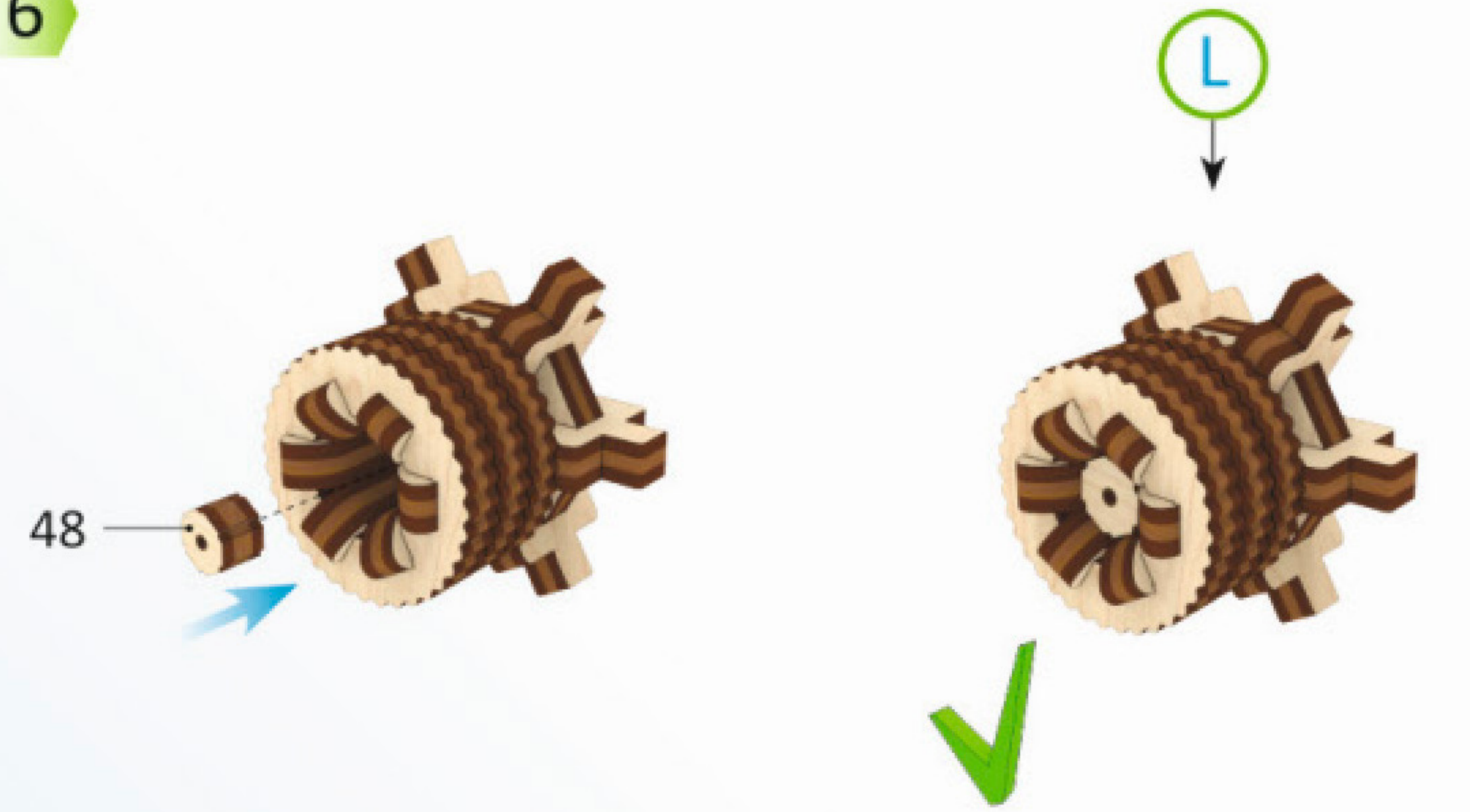

1

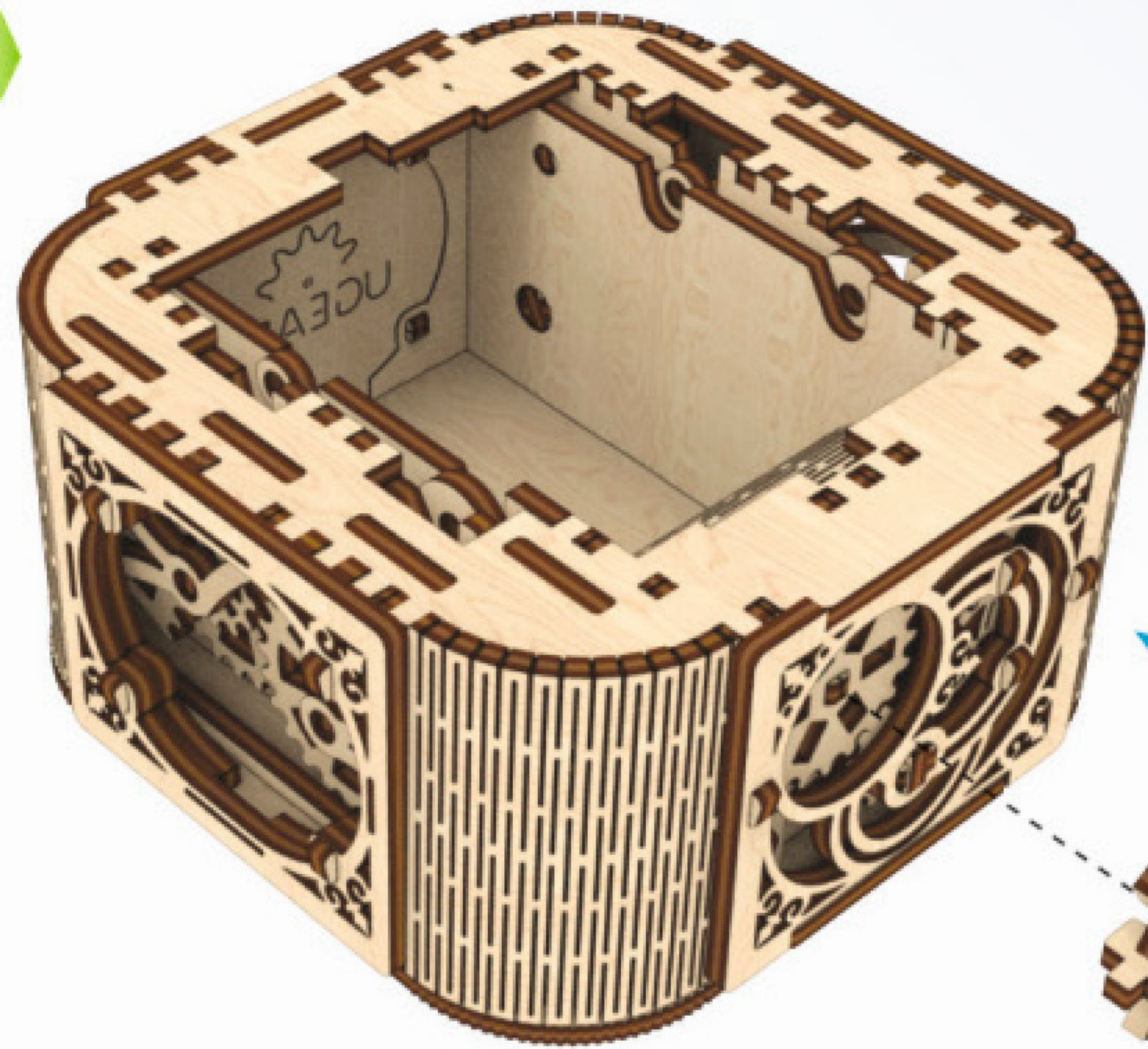

2

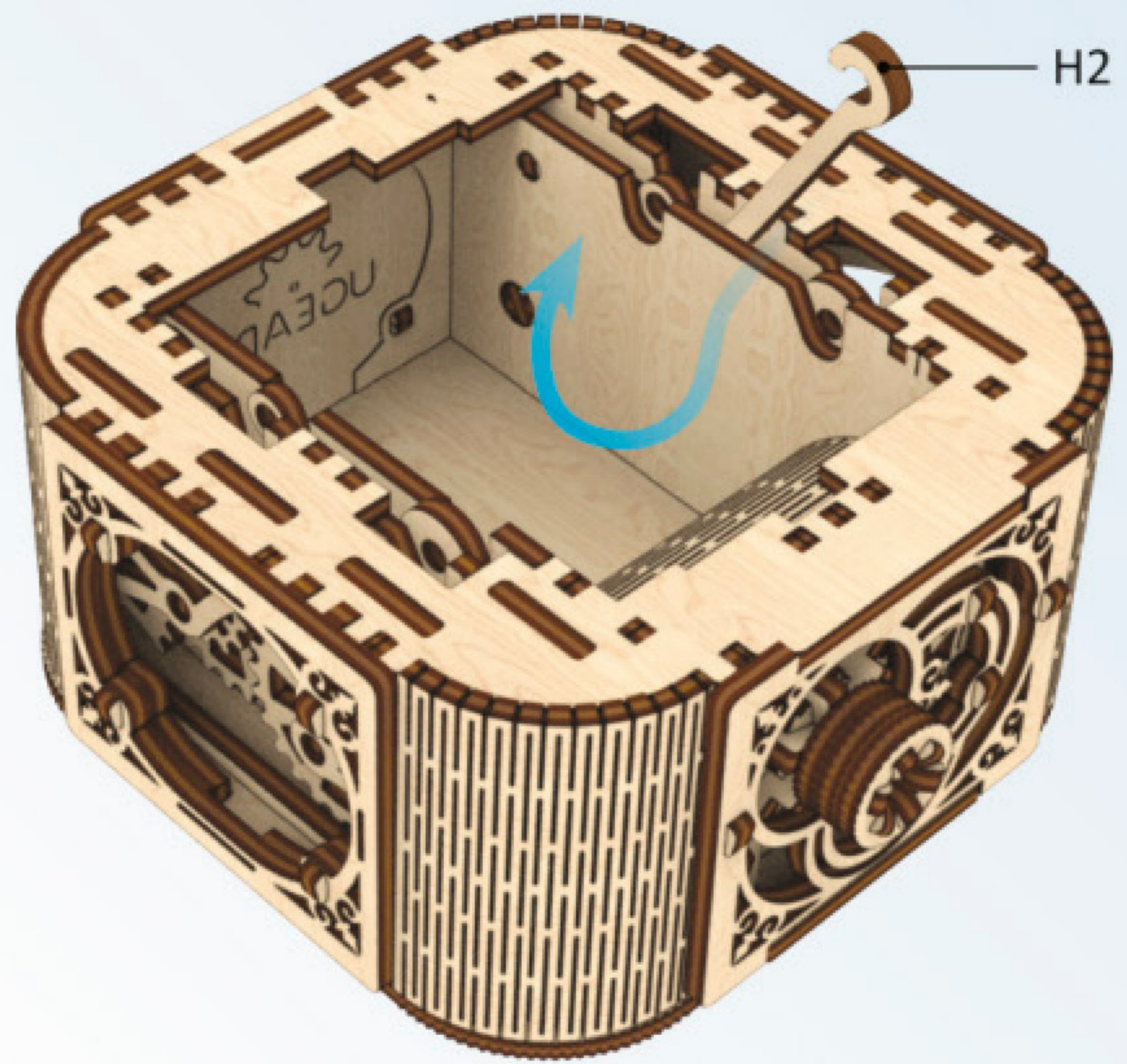

3

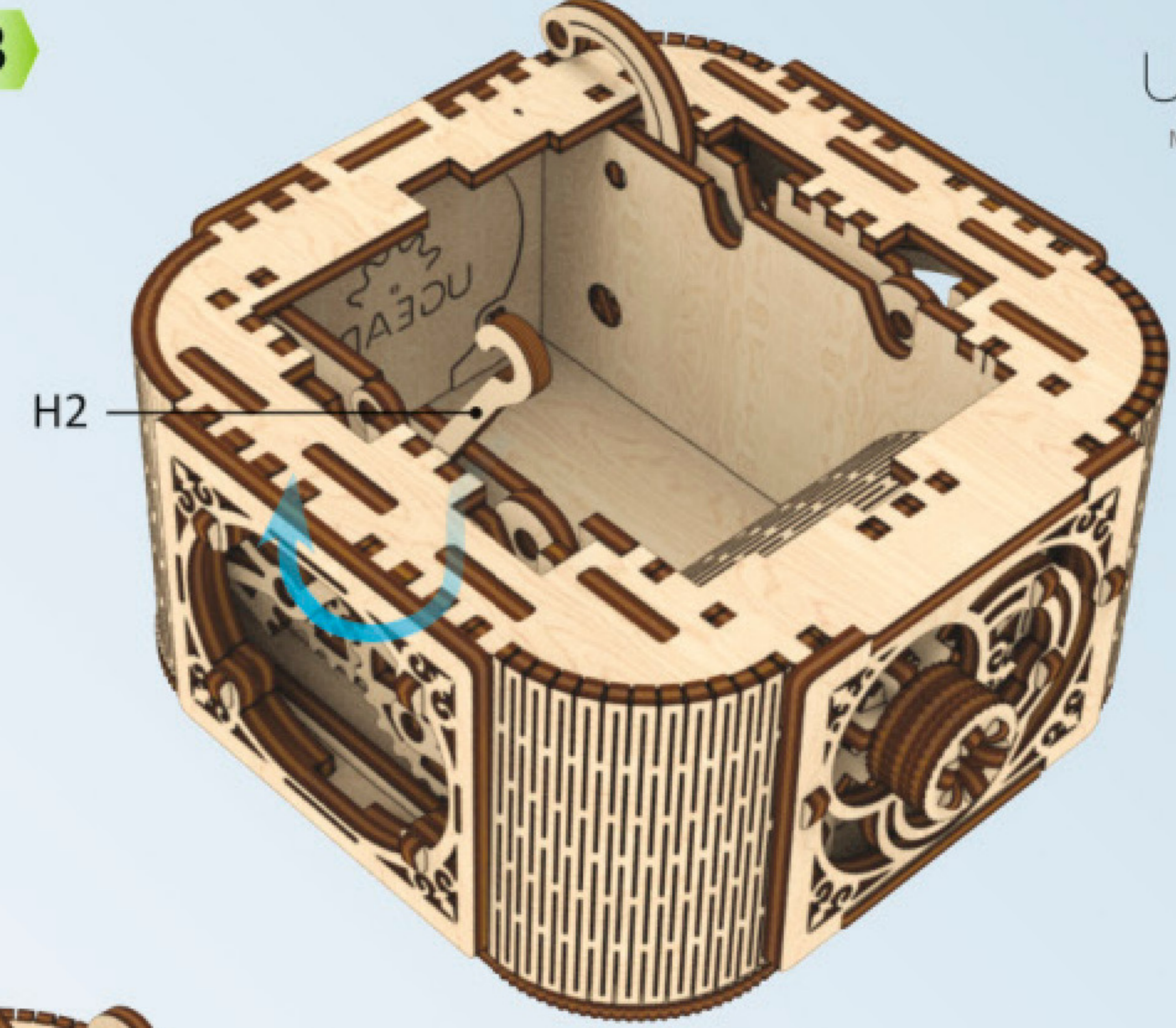

4

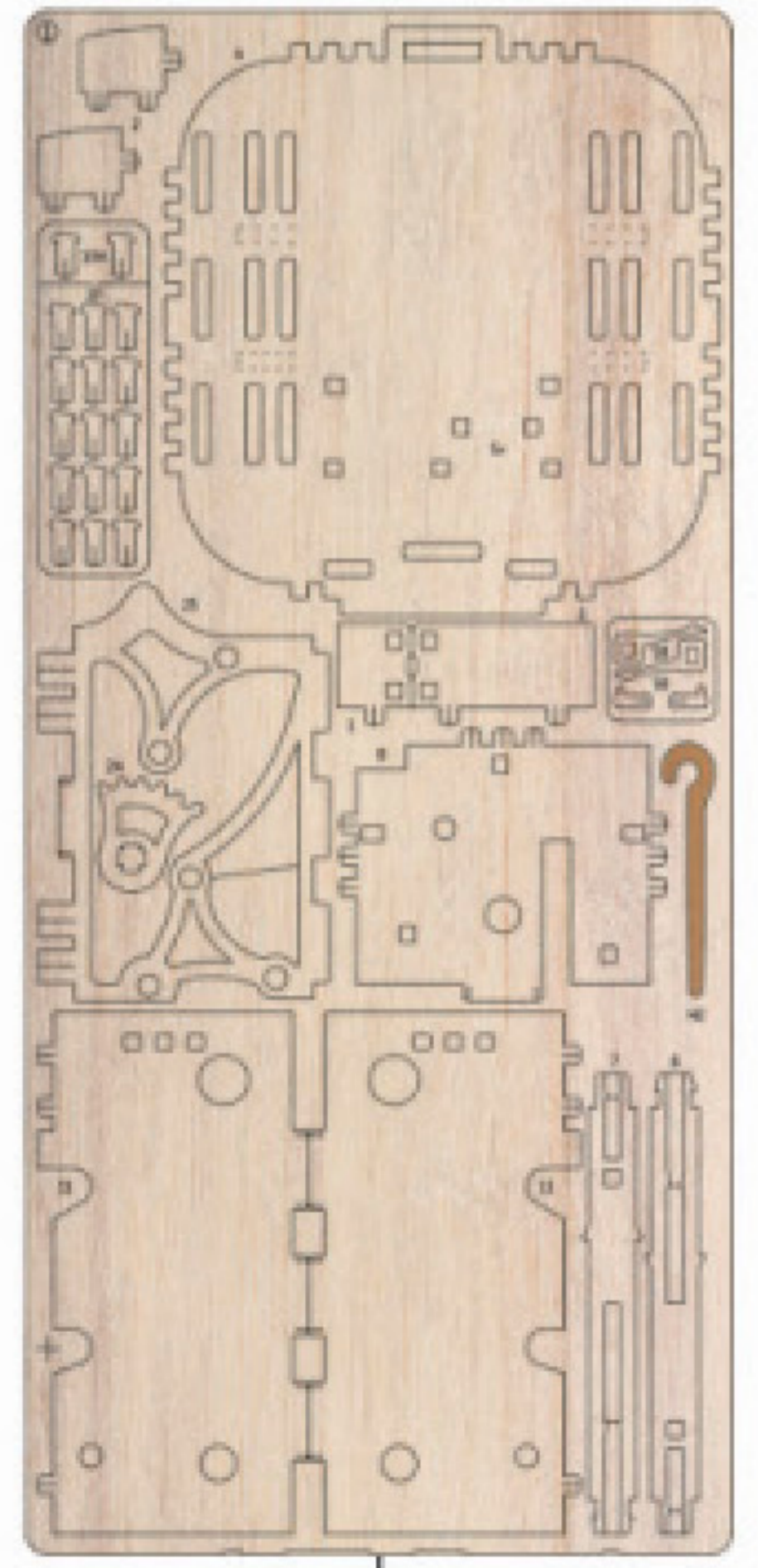
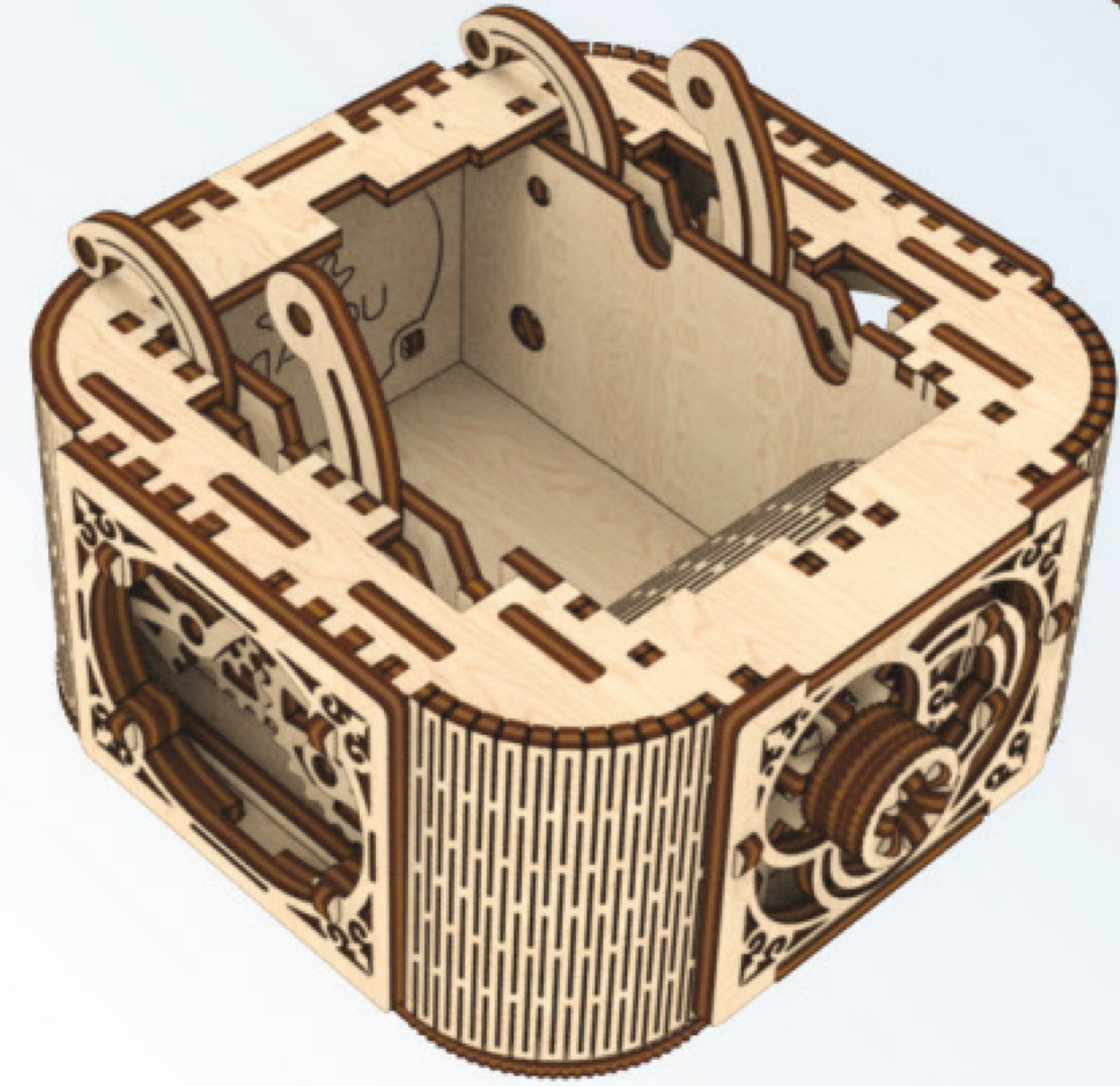
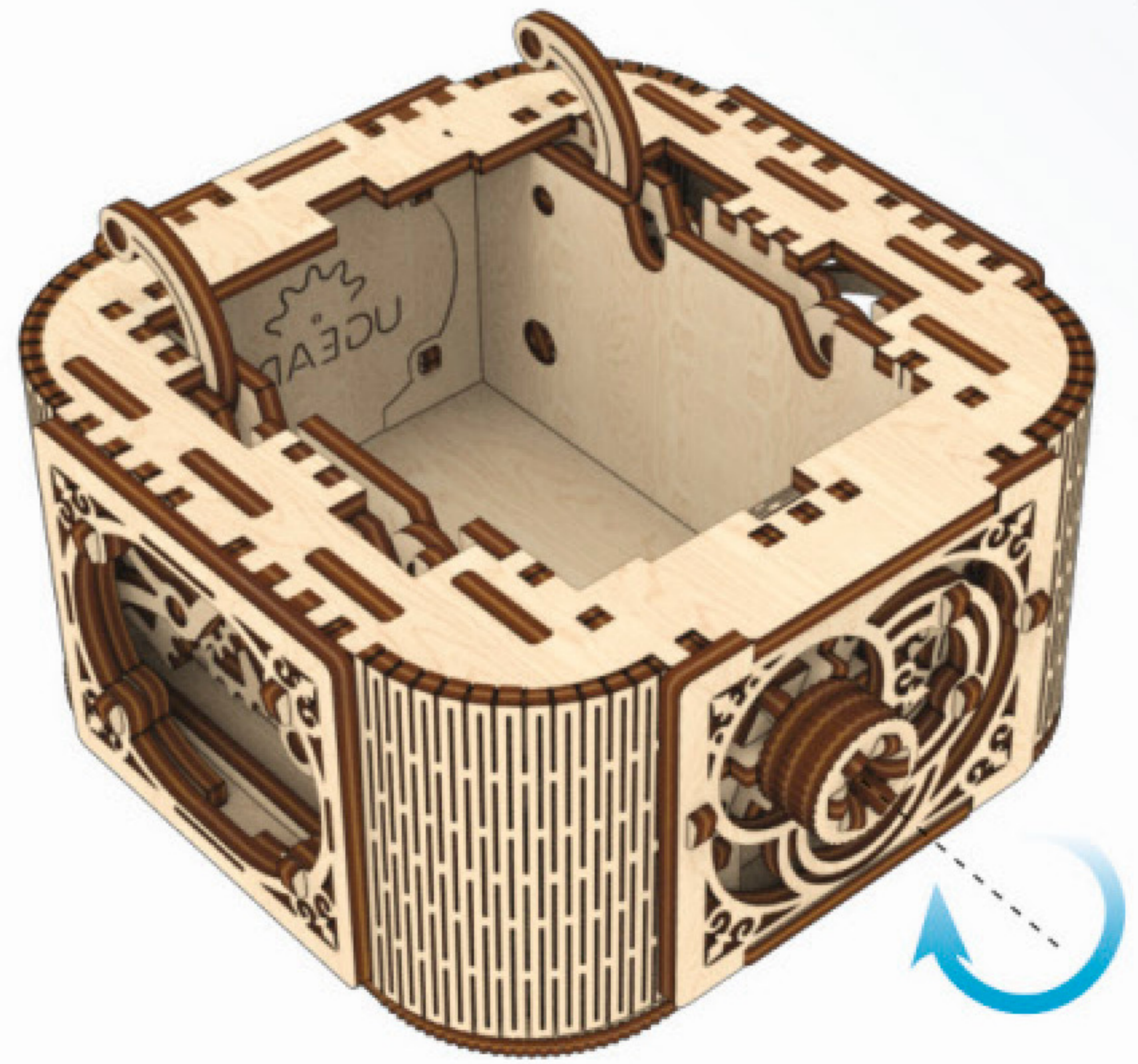

1

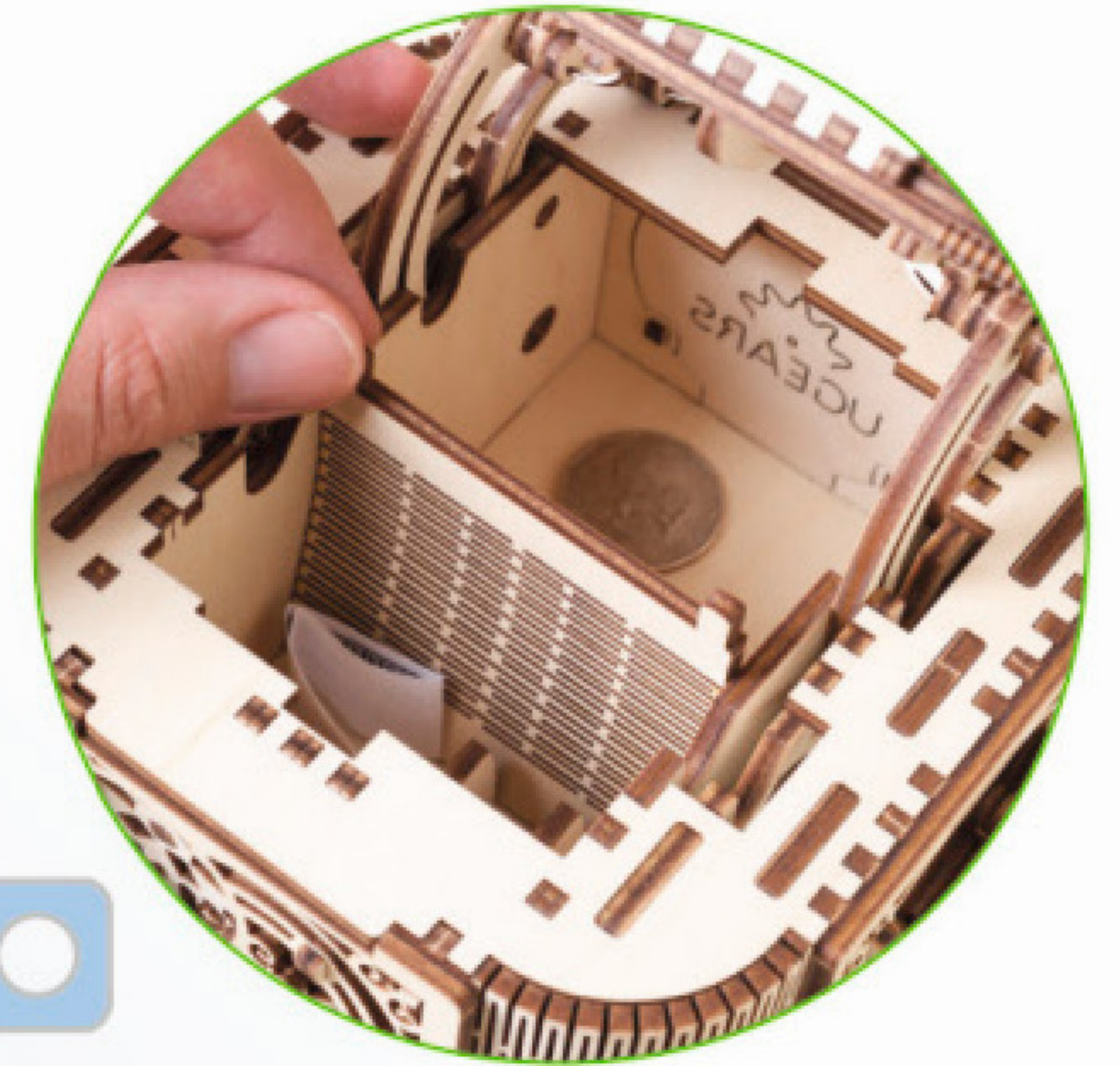
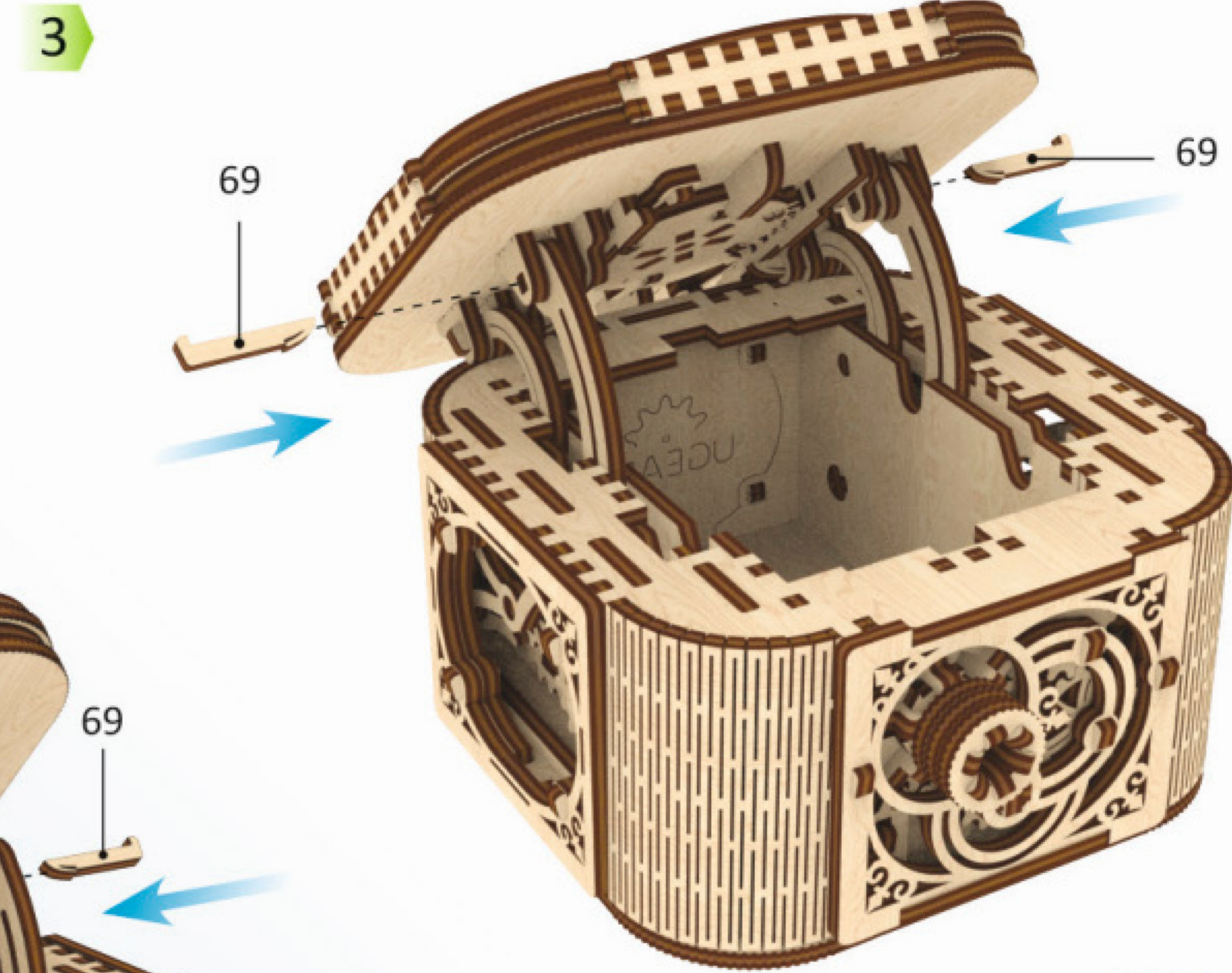
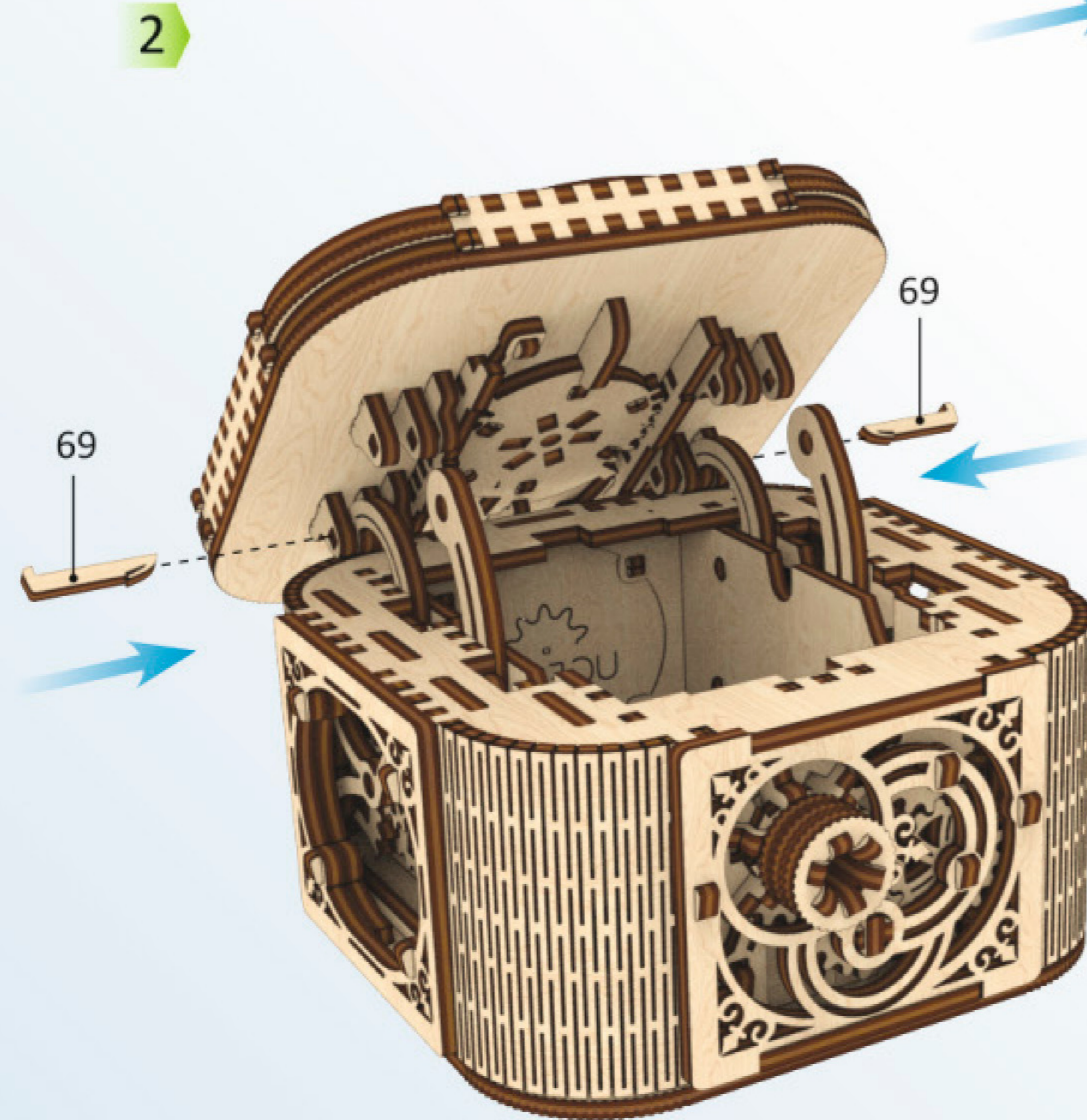
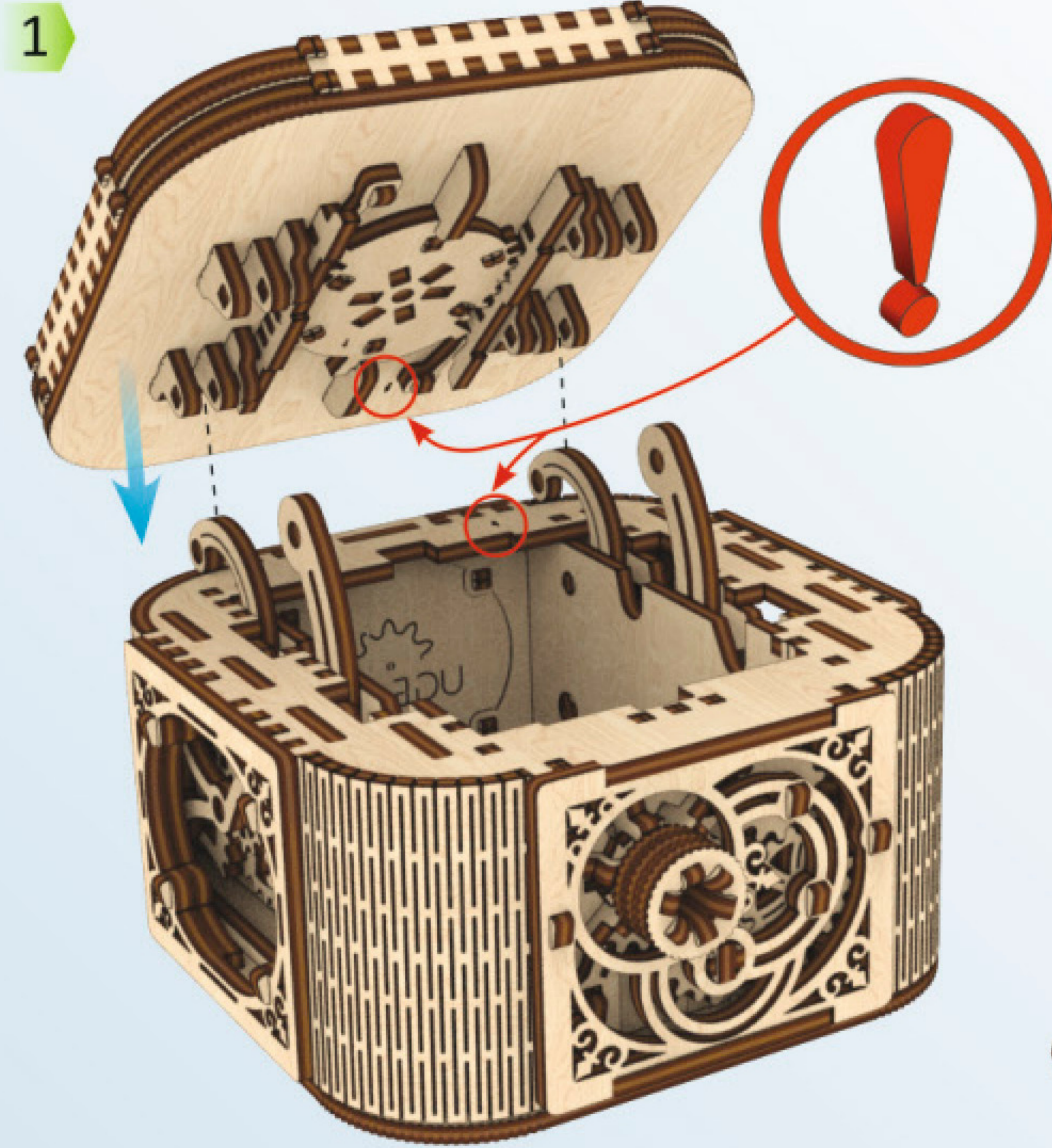
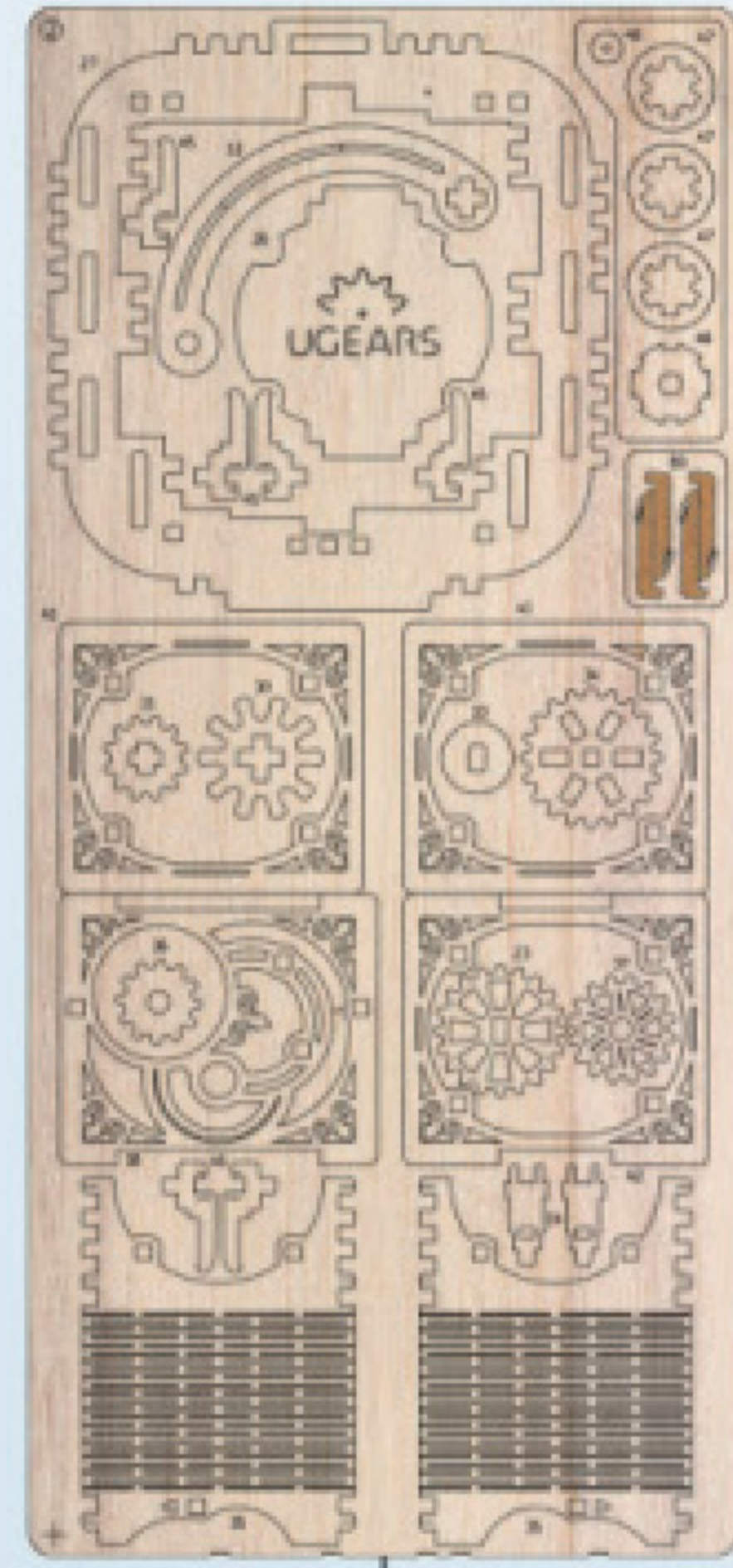

LOCK  
CLOSE

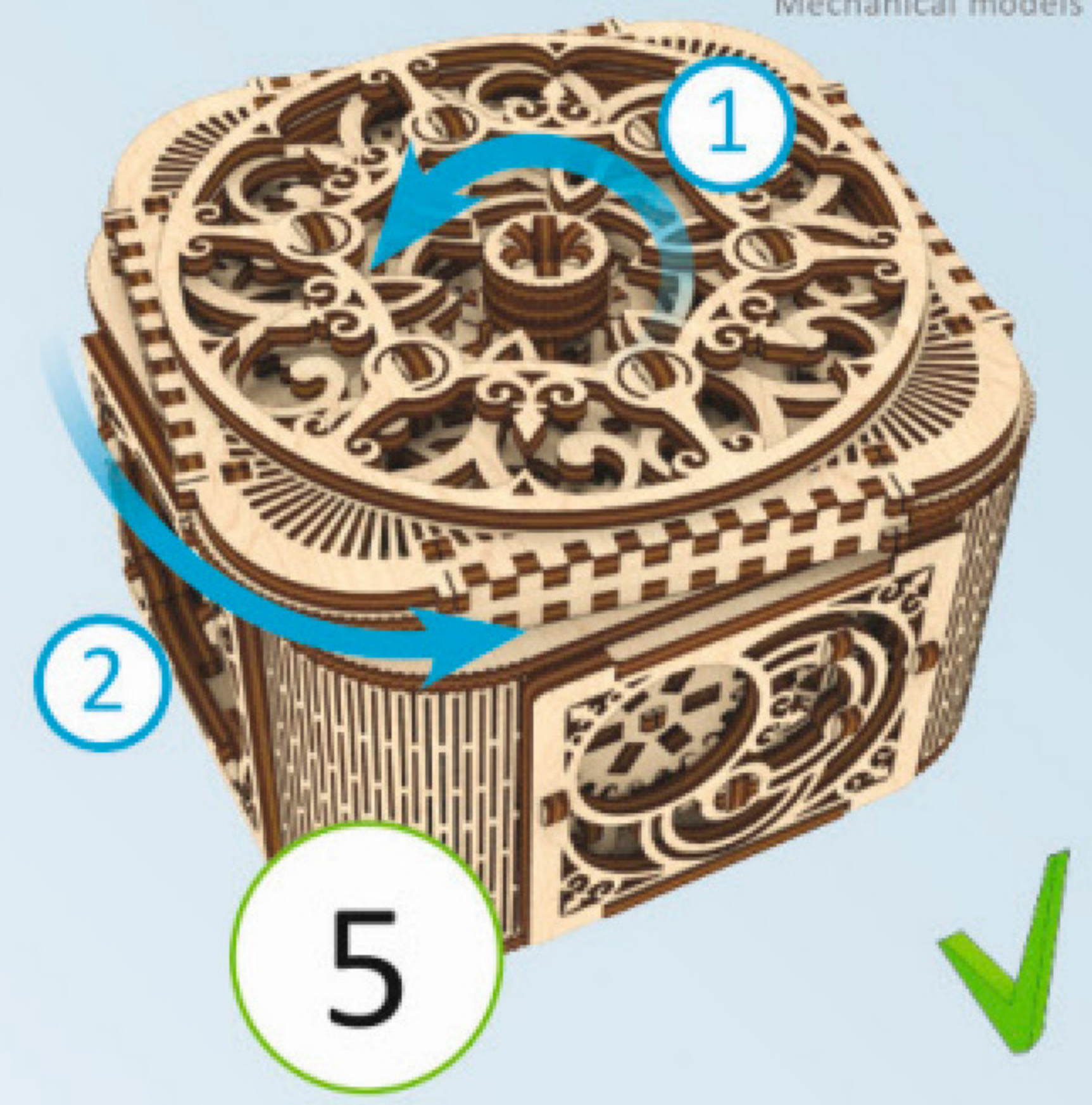
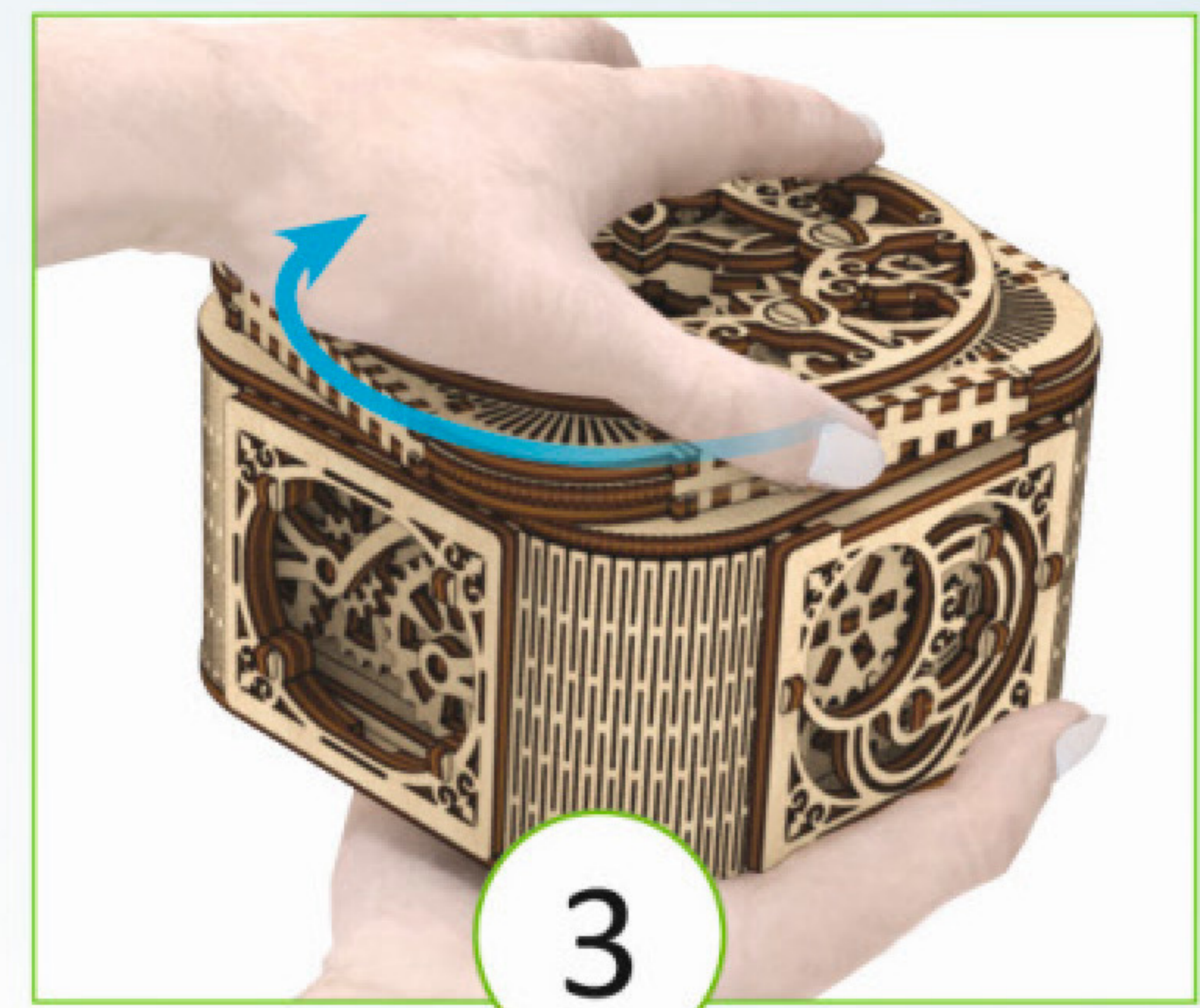

UNLOCK  
OPEN

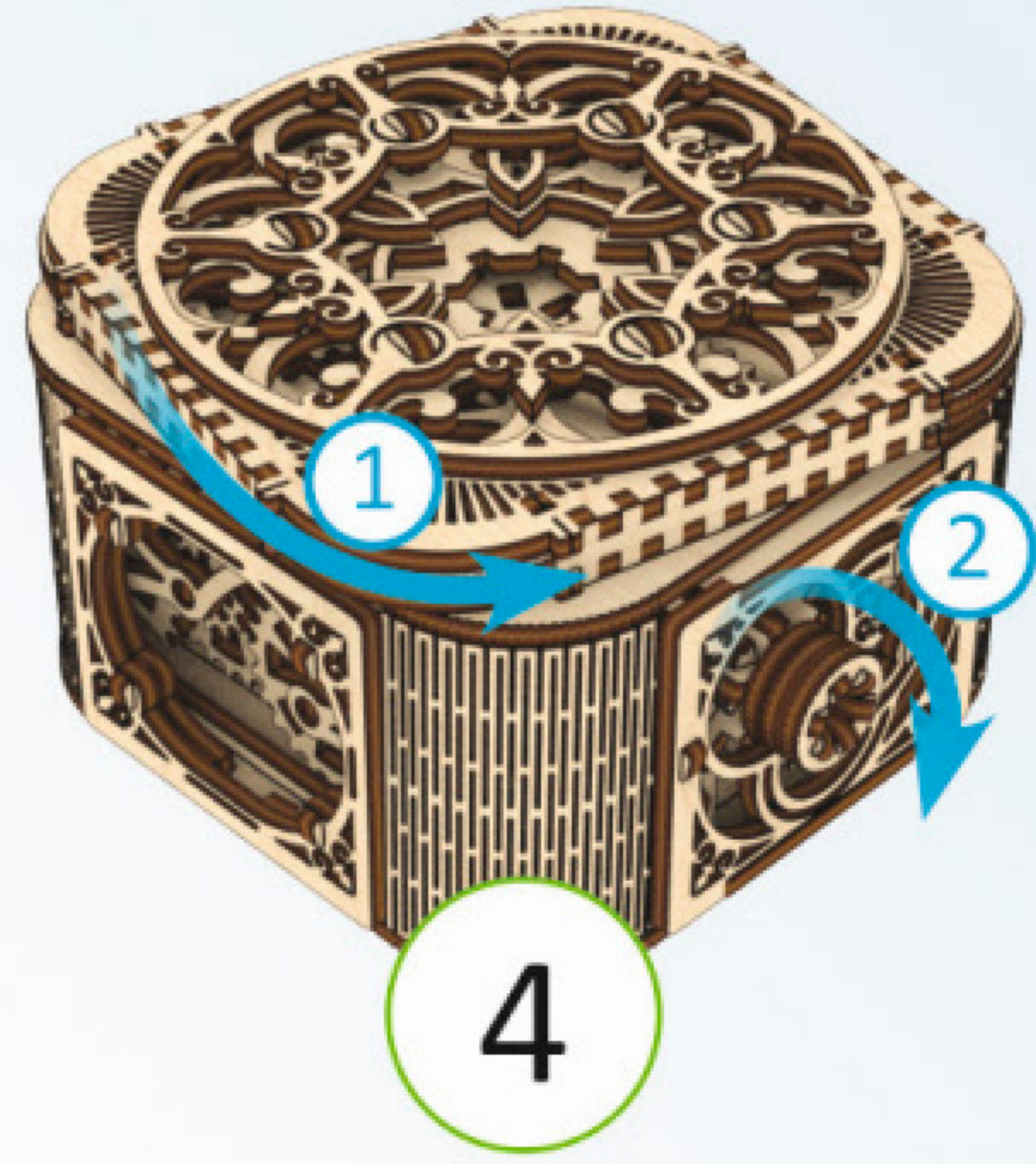
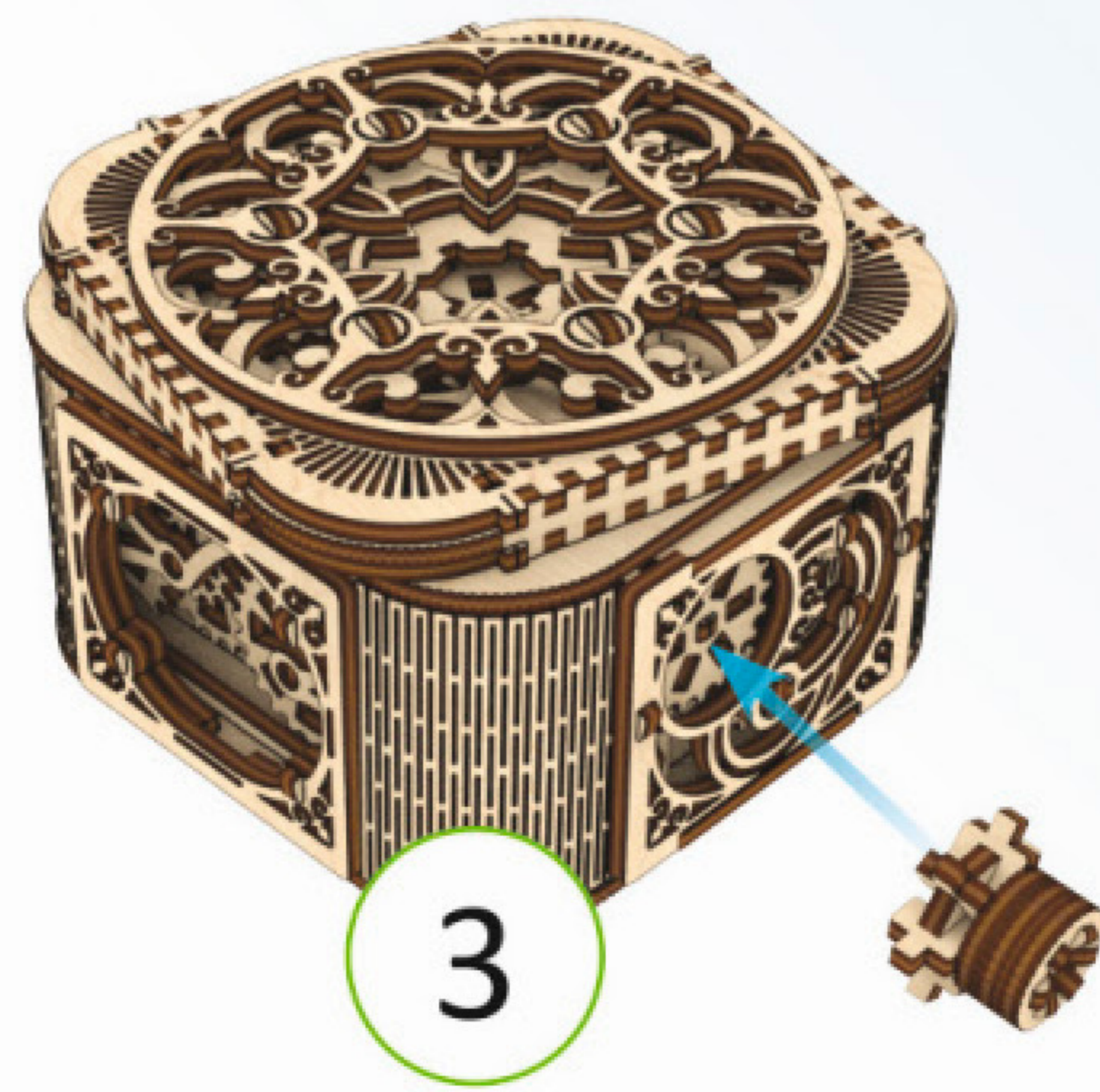
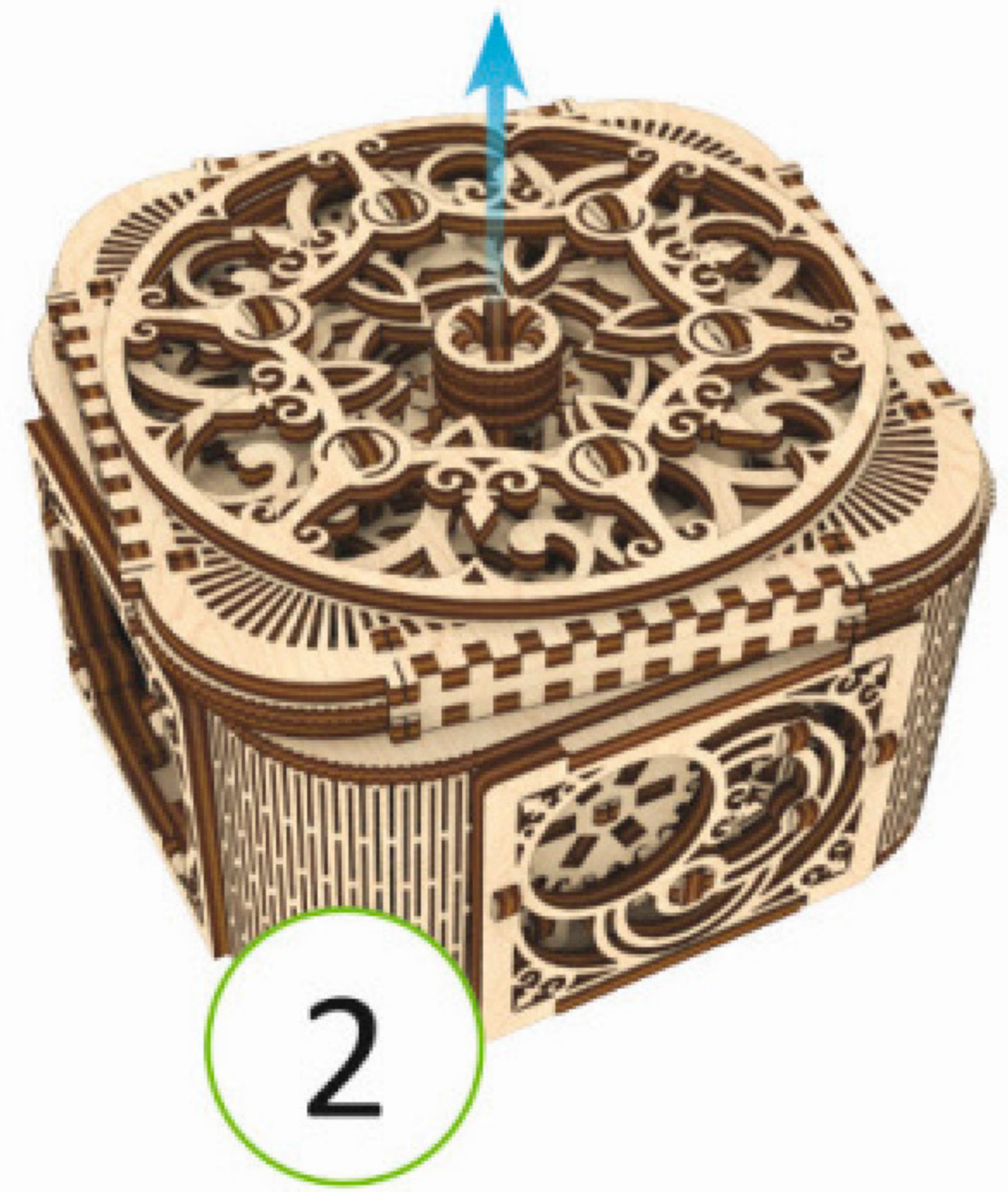
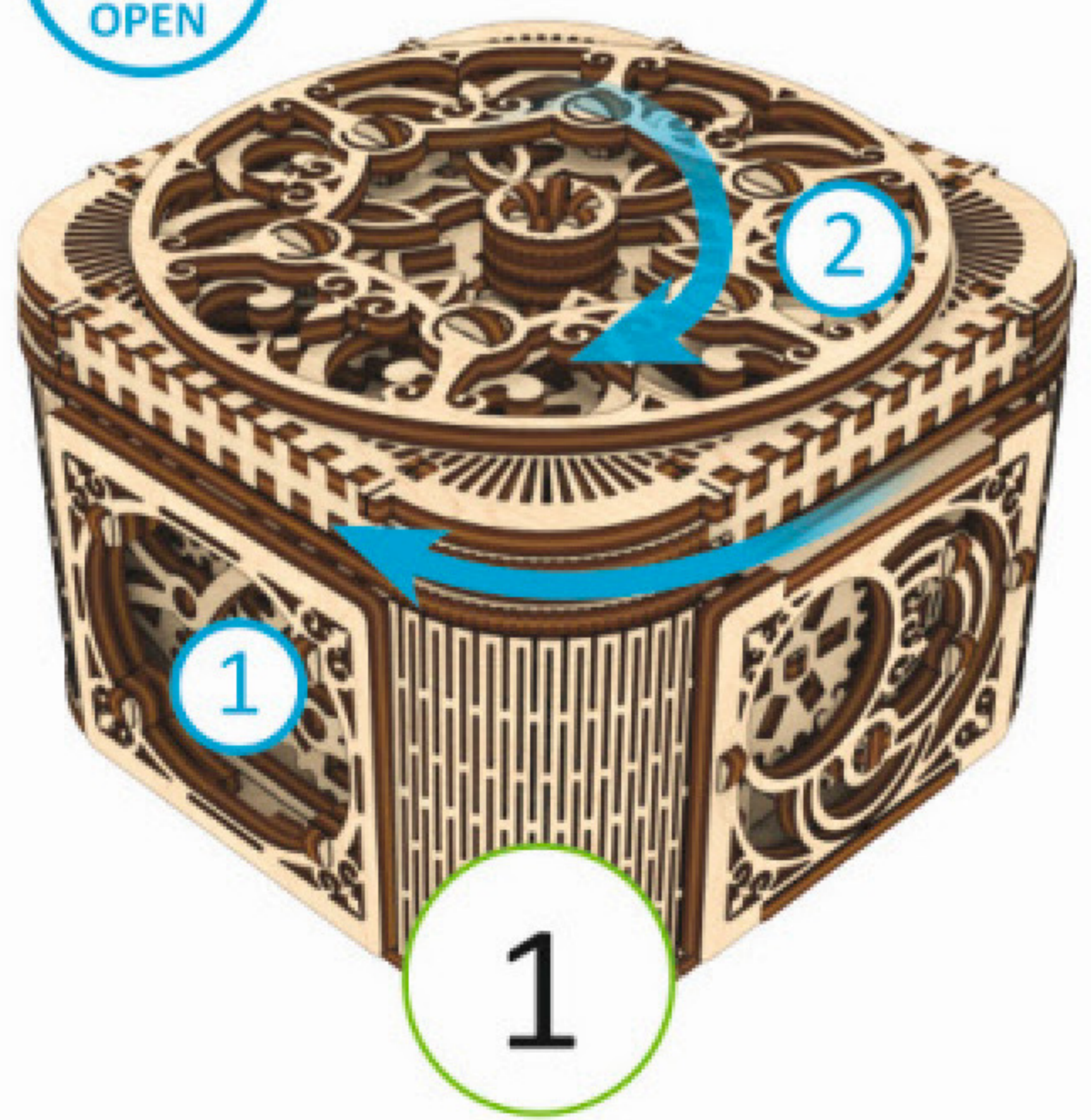



Bedankt voor de deelname aan deze reis met ons.

[ugears-shop.nl](https://ugears-shop.nl)

