

  
UGEAR<sup>®</sup>  
Mechanical models



Model "Timer van 20 min."

Nederlandische handleiding



## NED

### Bouwinstructies.

Verwijder de onderdelen van de borden zoals hieronder is geïllustreerd. Pas op dat de onderdelen niet breken. Wanneer het niet loskomt, gebruik dan voorzichtig een mesje. Dit model bouwt u zelf zonder gebruik te maken van lijm. Wanneer onderdelen moeilijk te plaatsen zijn. Smeer deze dan in met een kaars. Om frictie te voorkomen behandelt u ook alle beweegbare onderdelen met een kaars.

### Waarschuwing!



Gebruik geen kaars die brand!



Opgepast, de spieën zijn scherp!

## Pictogrammen.



Smeer het onderdeel in met kaarsvet.

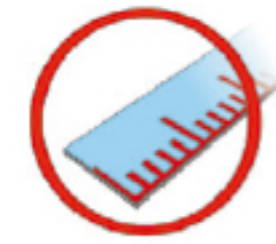

Controleer grootte.

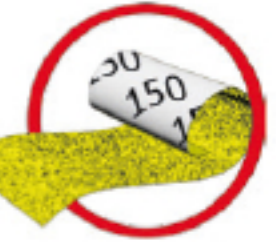

Schuur om de bramen te verwijderen.



Breek of snij het onderdeel uit.



Opgelet! Controleer de goede positie.



Reserveonderdelen.



Snijd dwarsstukken voordat u het onderdeel van het bord verwijdert.

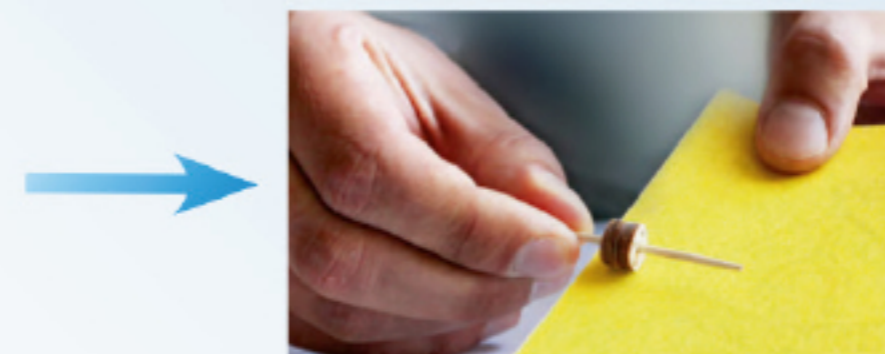

Dit is geen onderdeel. Het is een gereedschap voor meting en montage. Leder model heeft z'n eigen gereedschap.



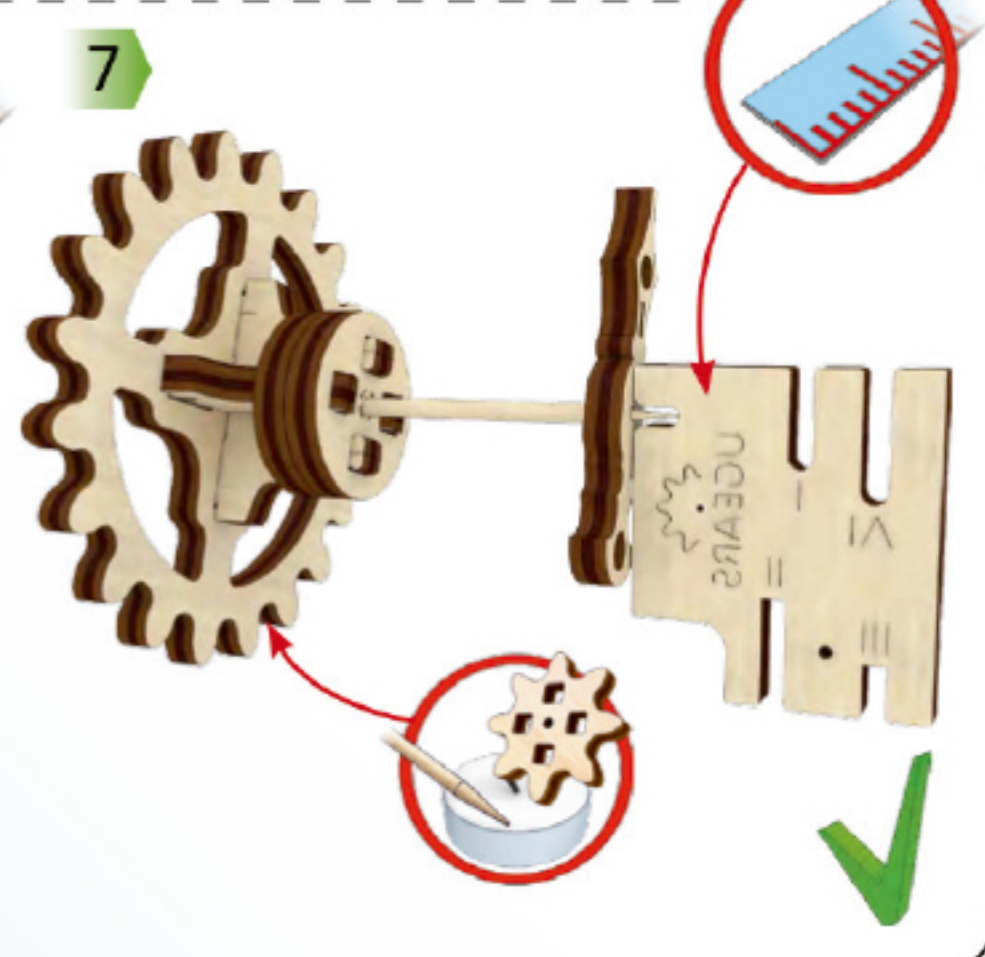
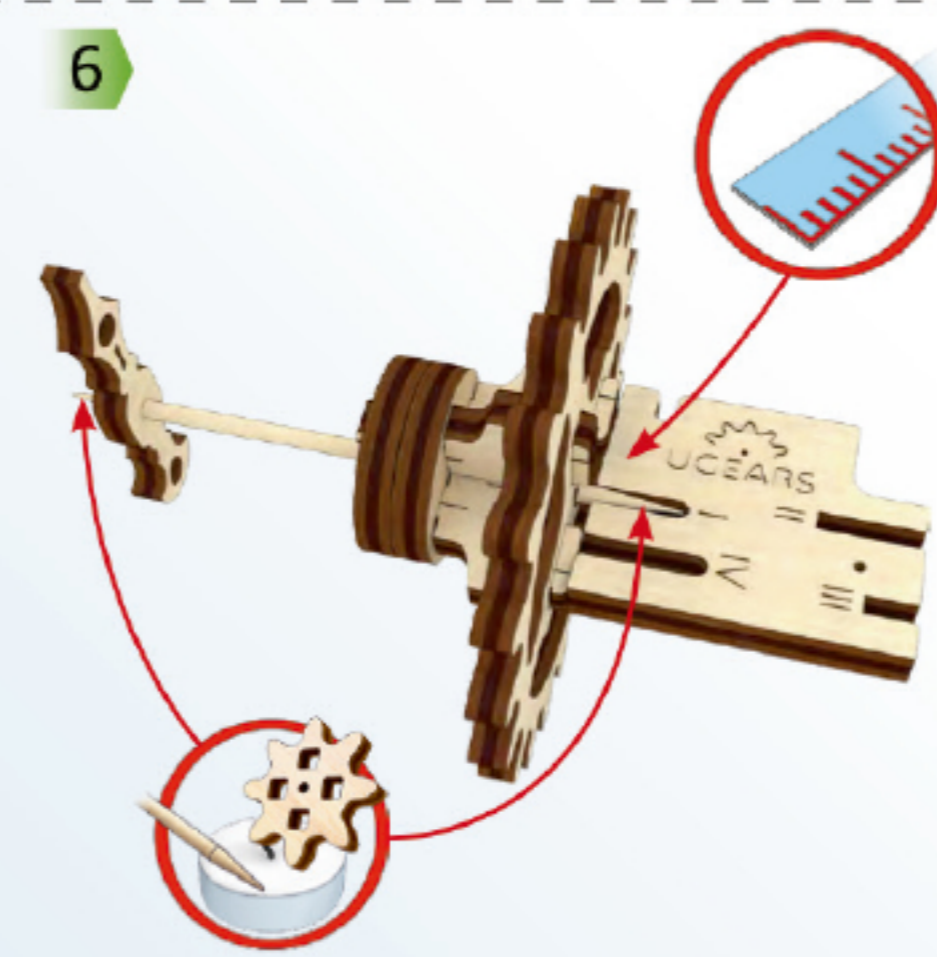
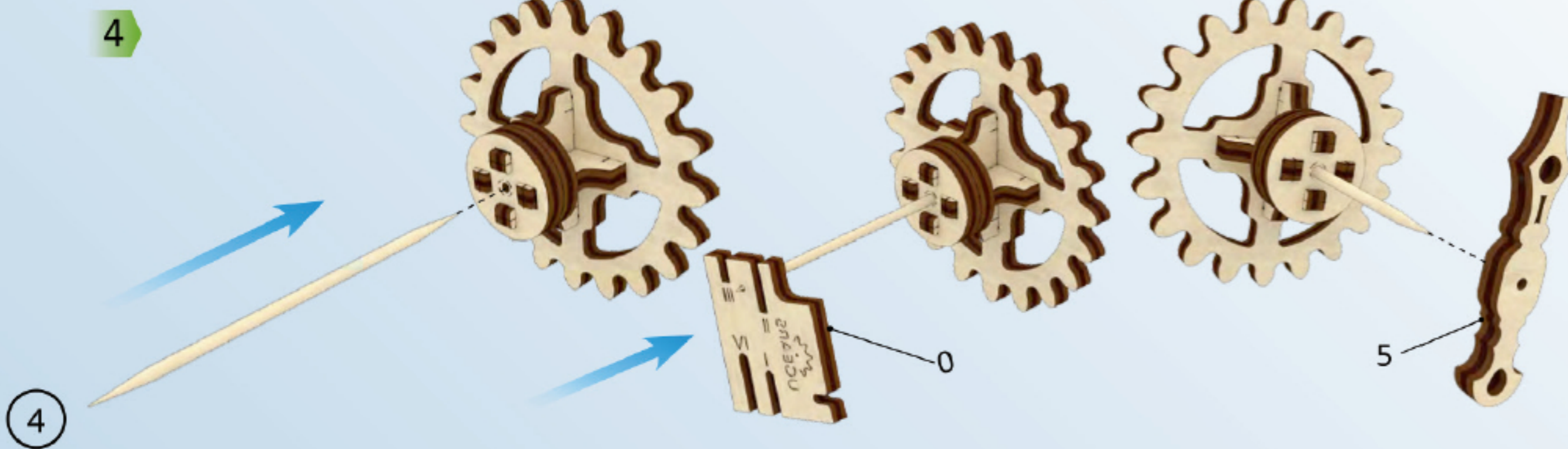
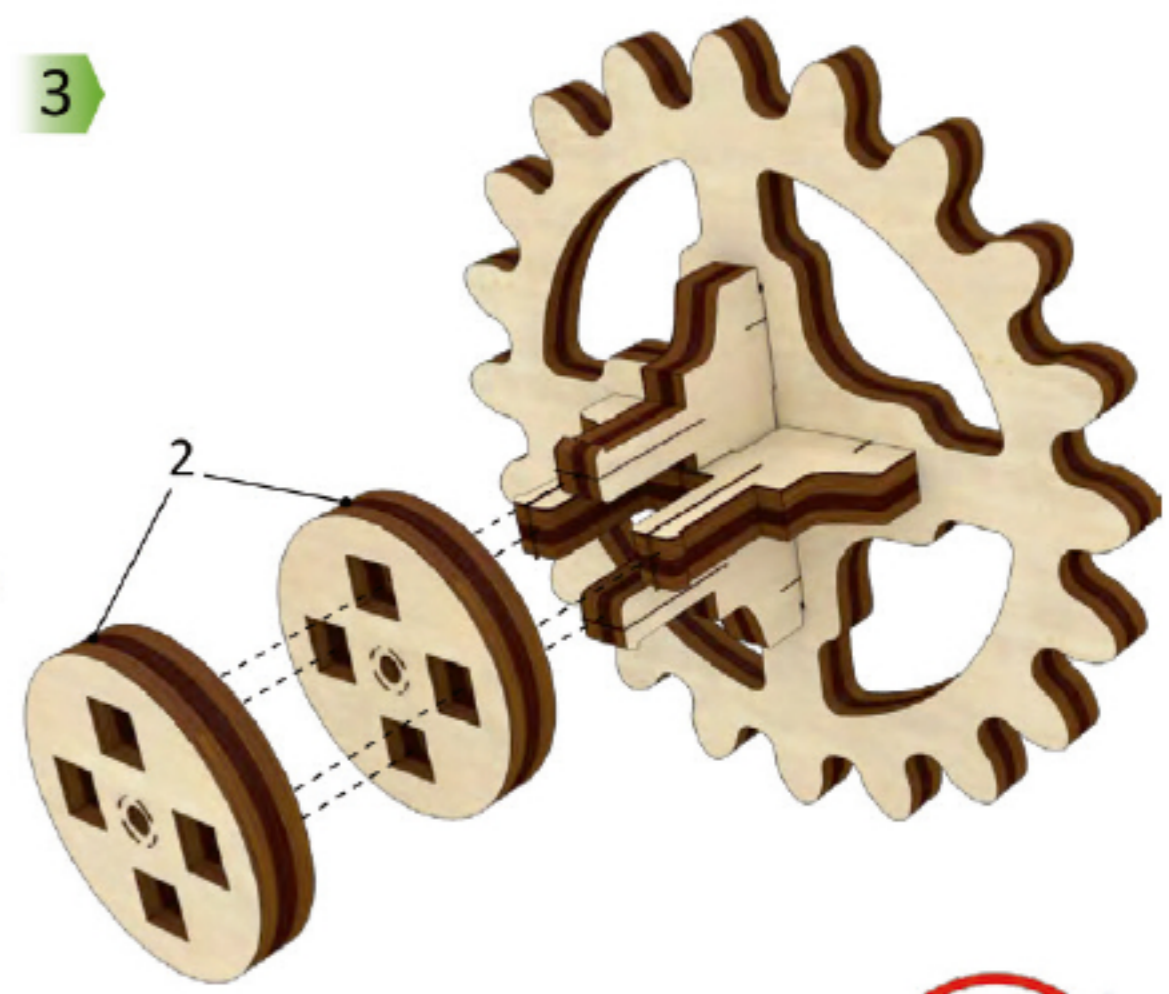
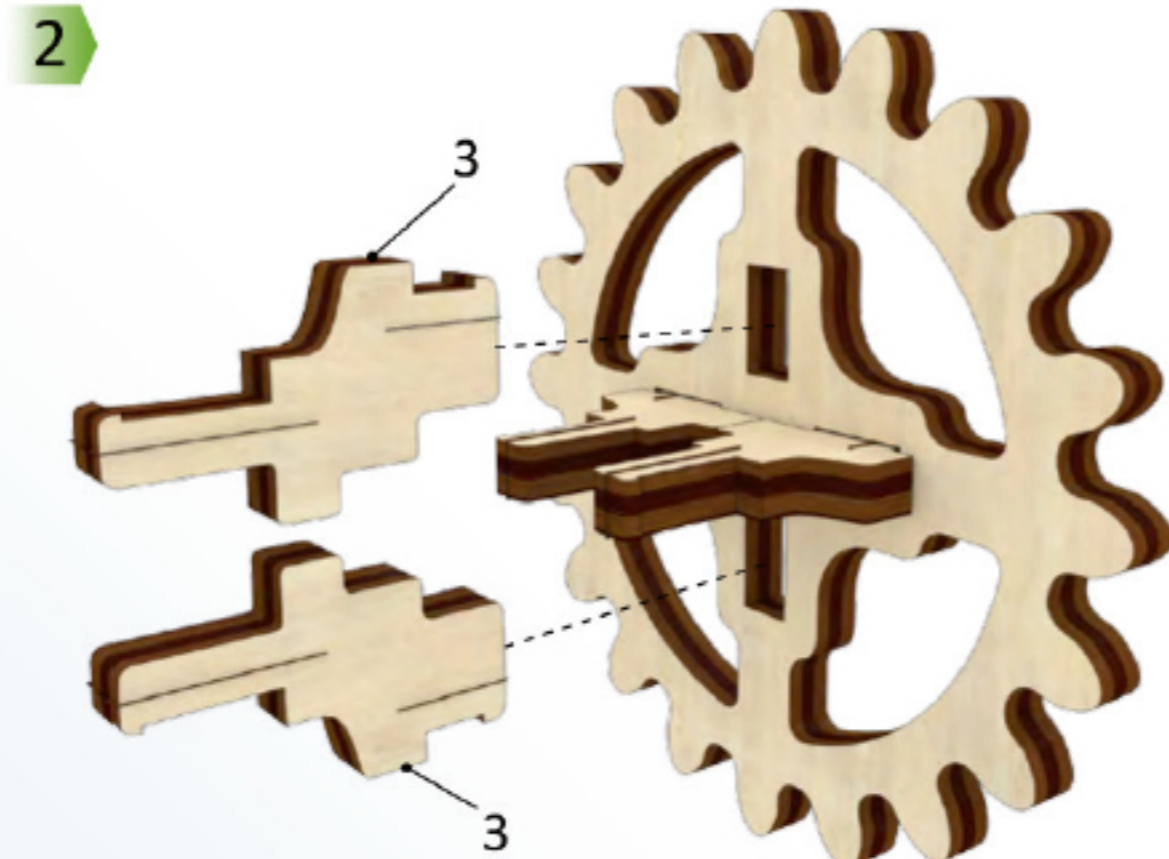
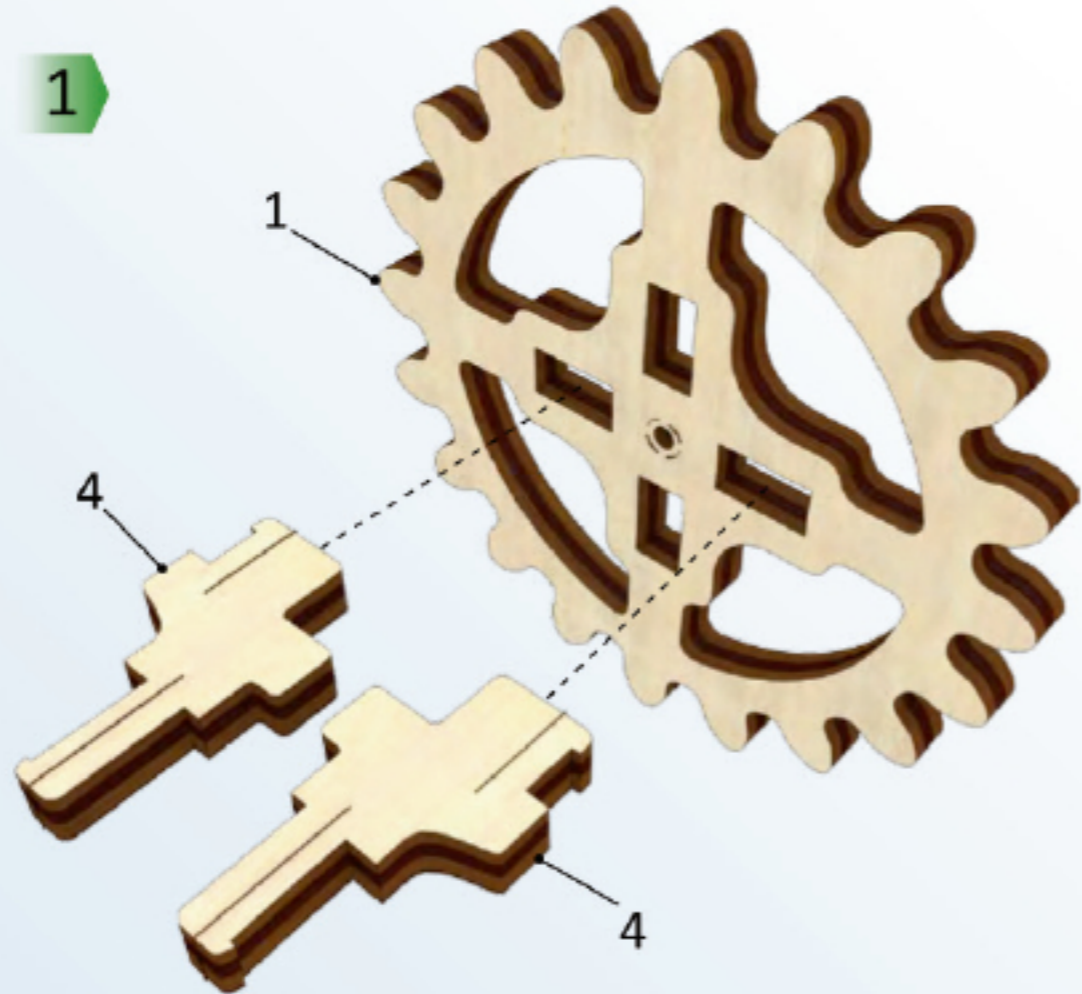
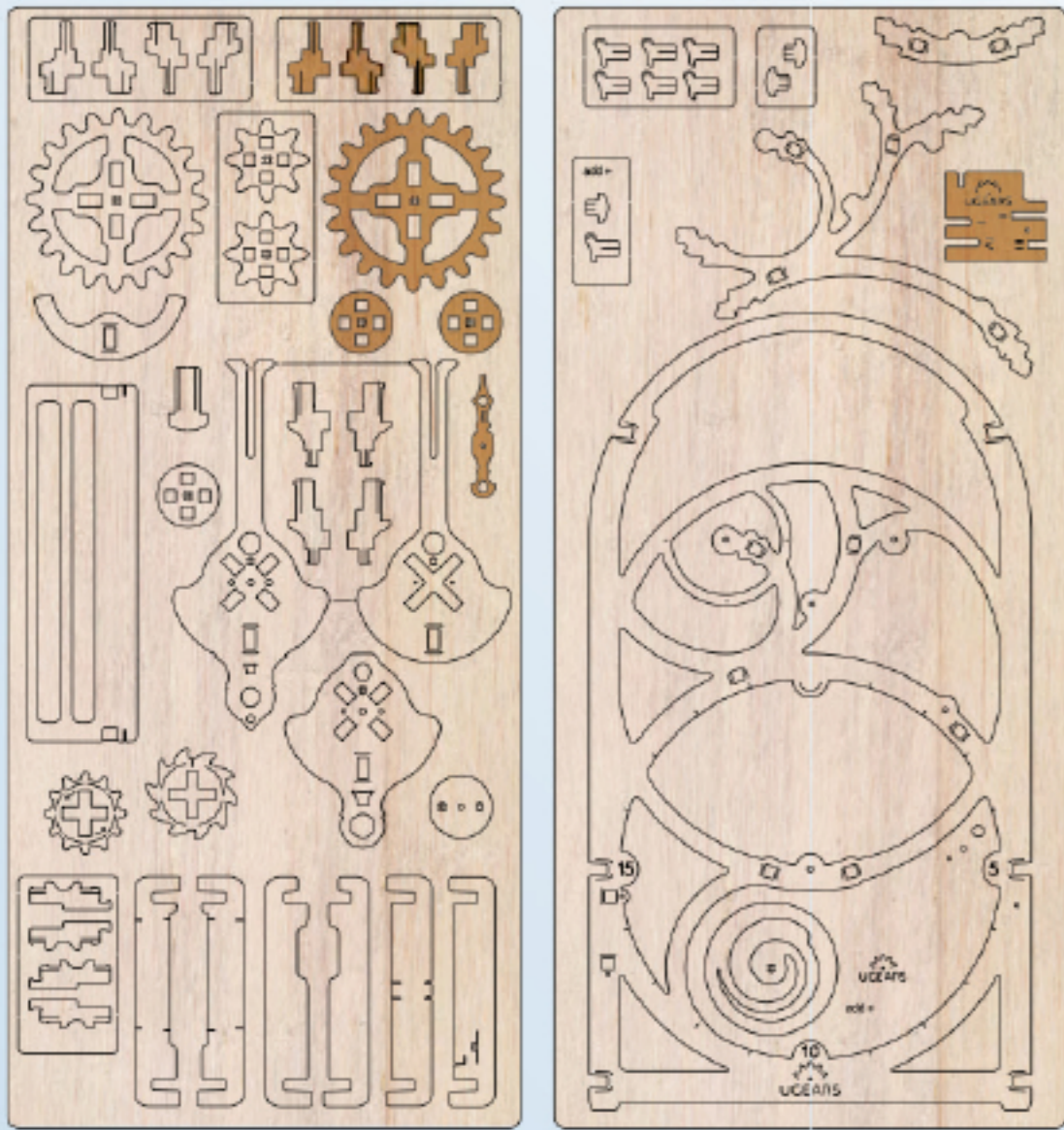

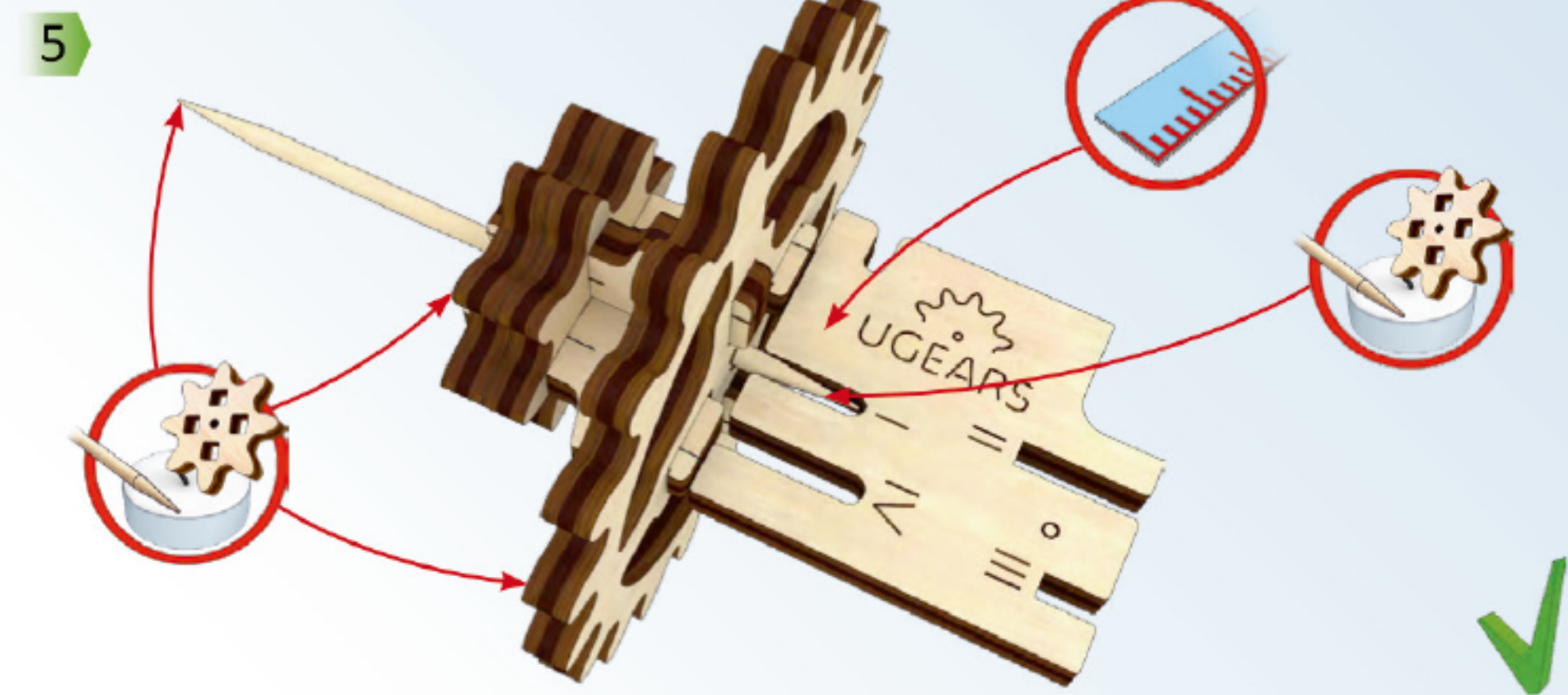
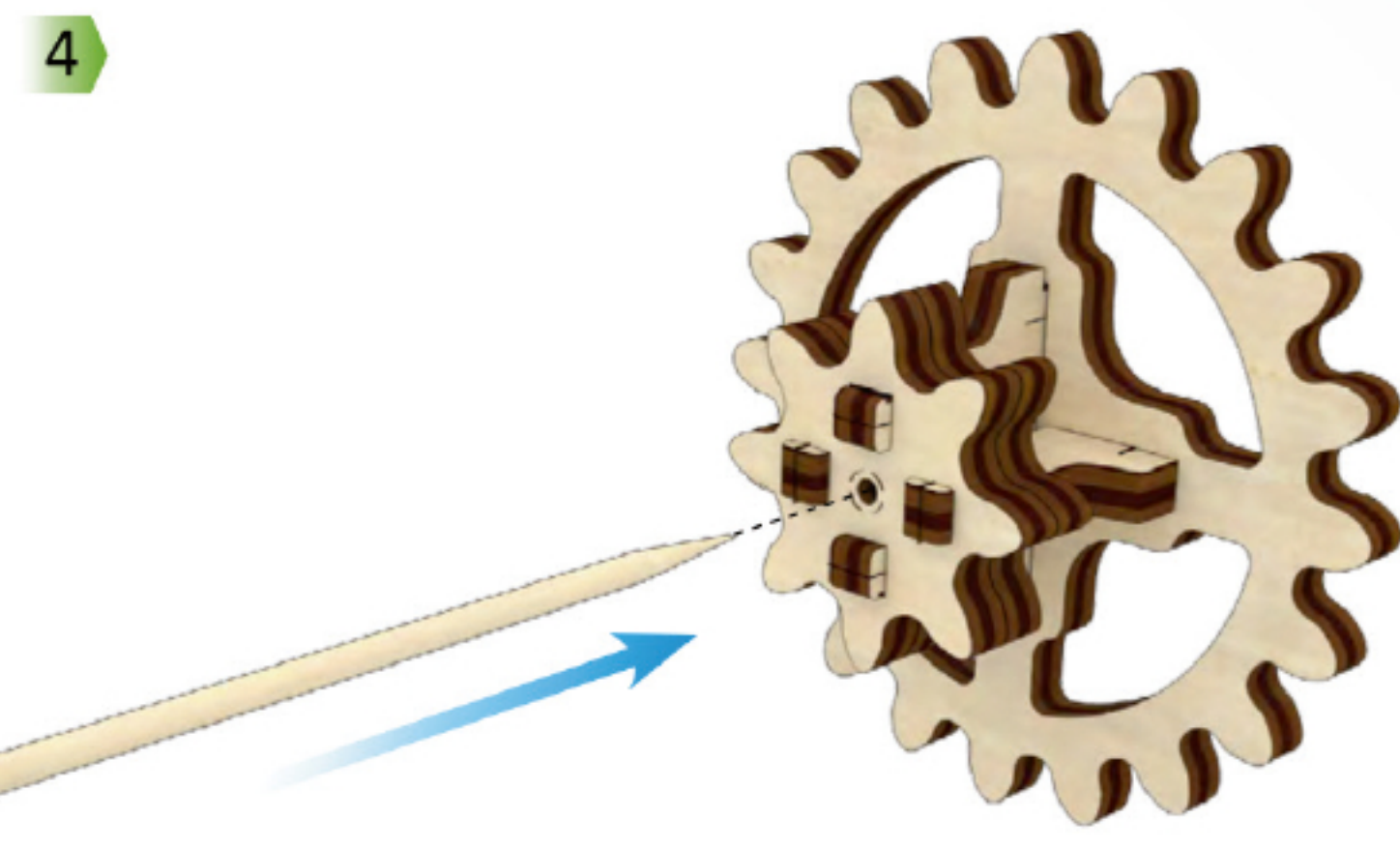
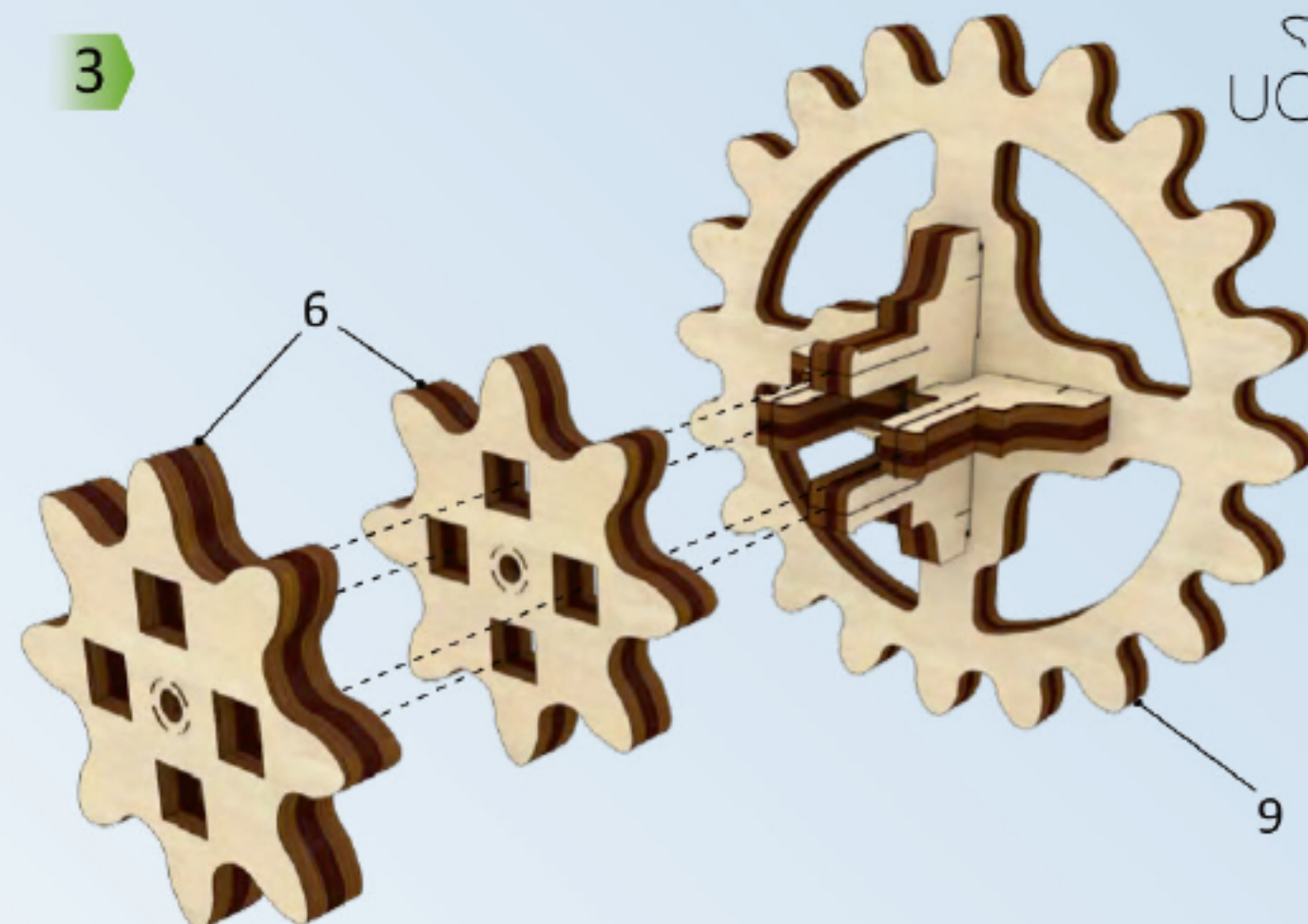
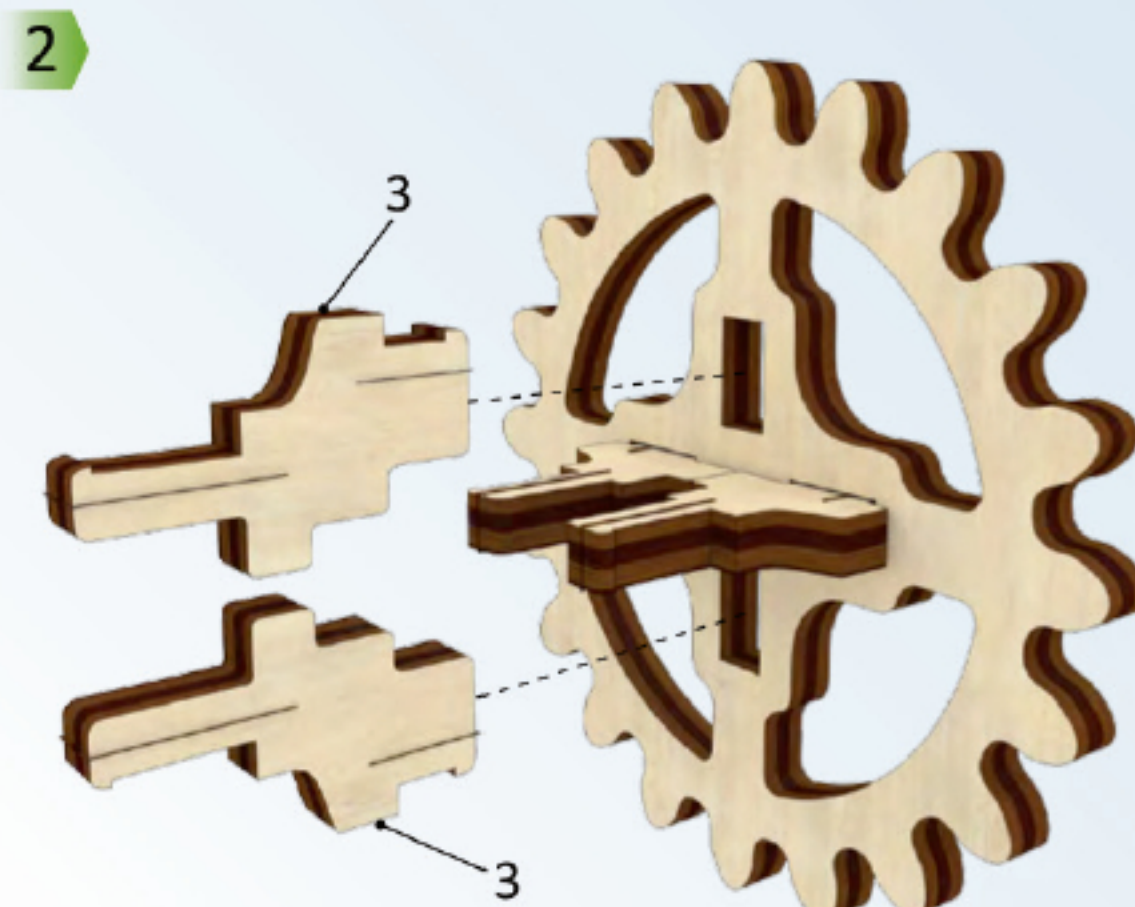
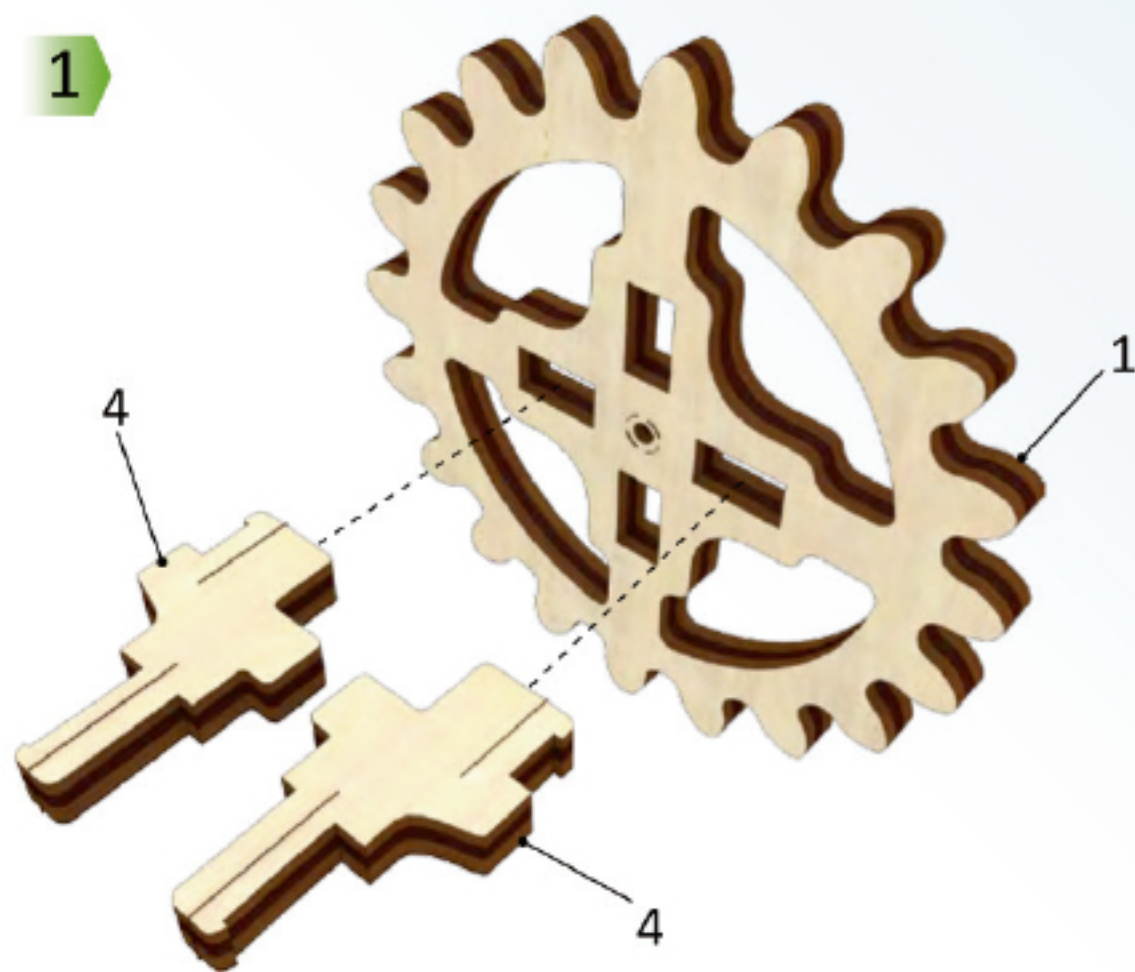
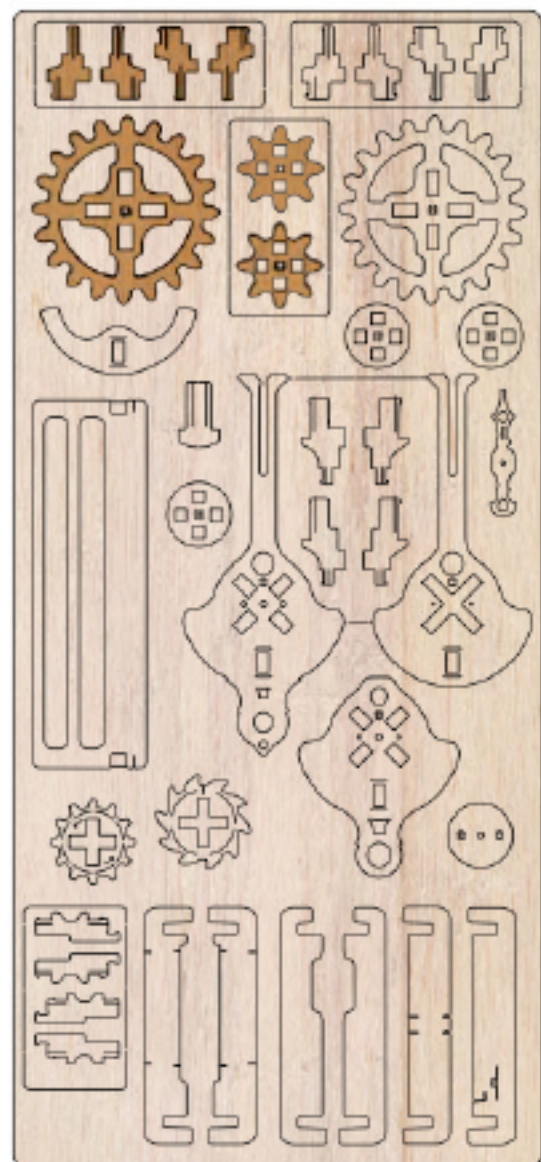

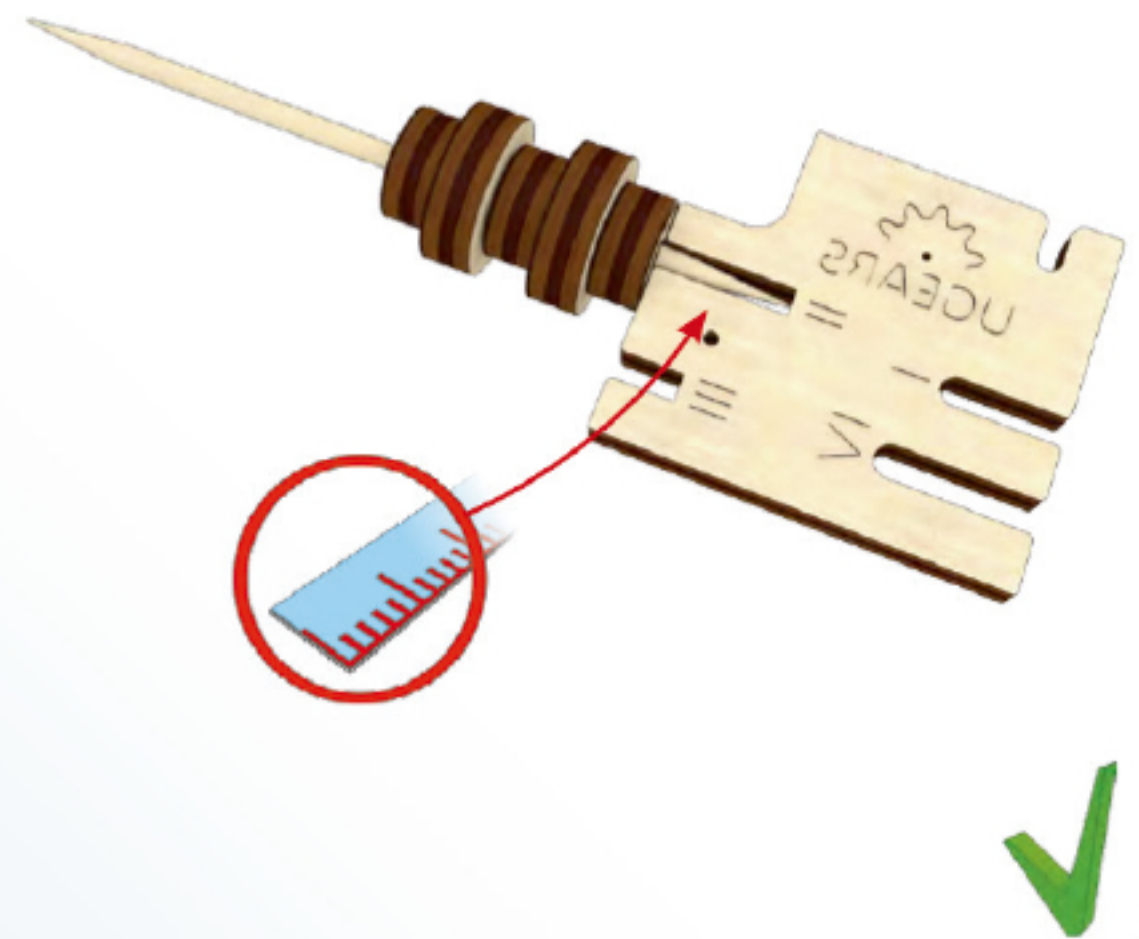
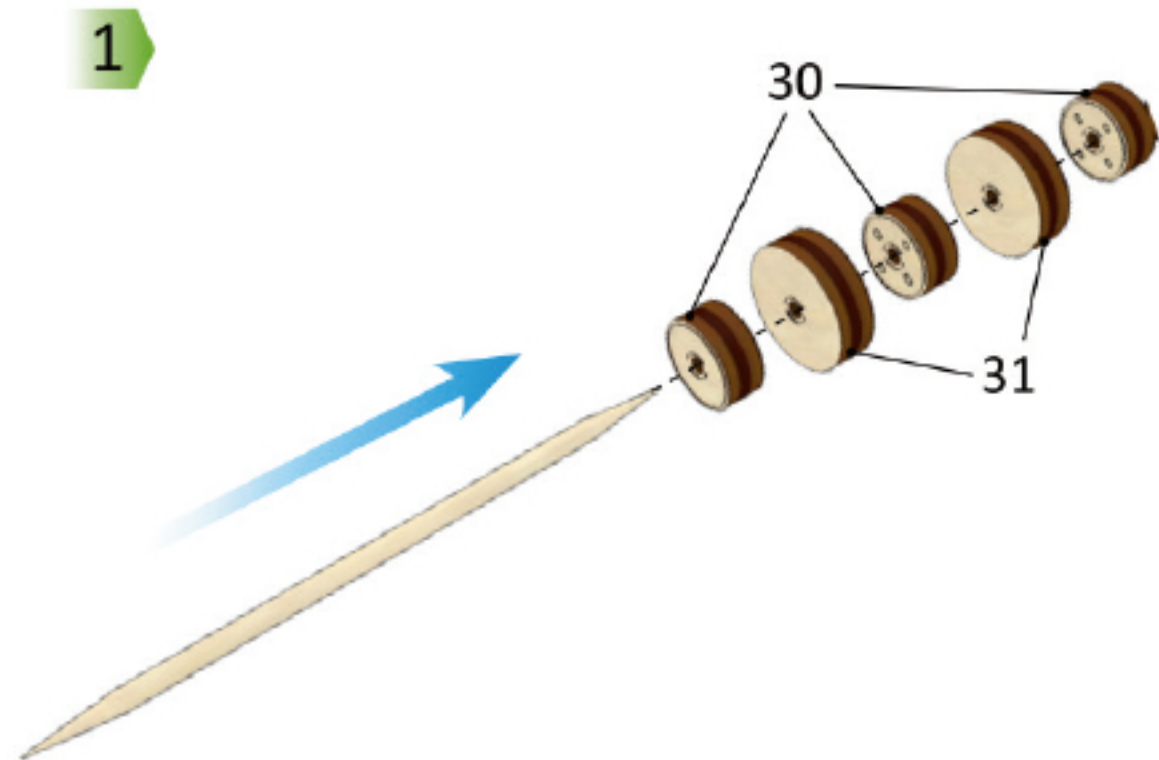
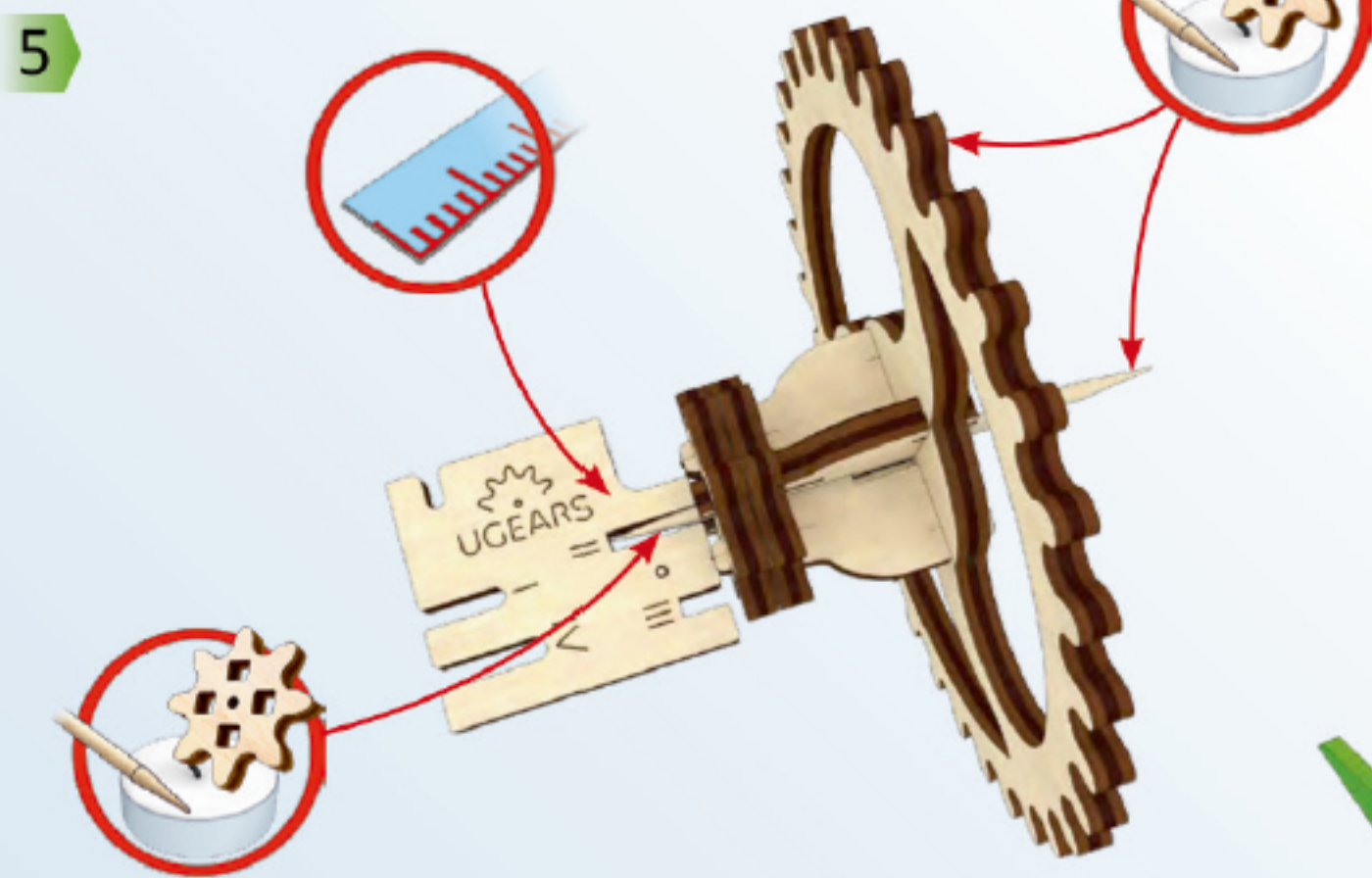
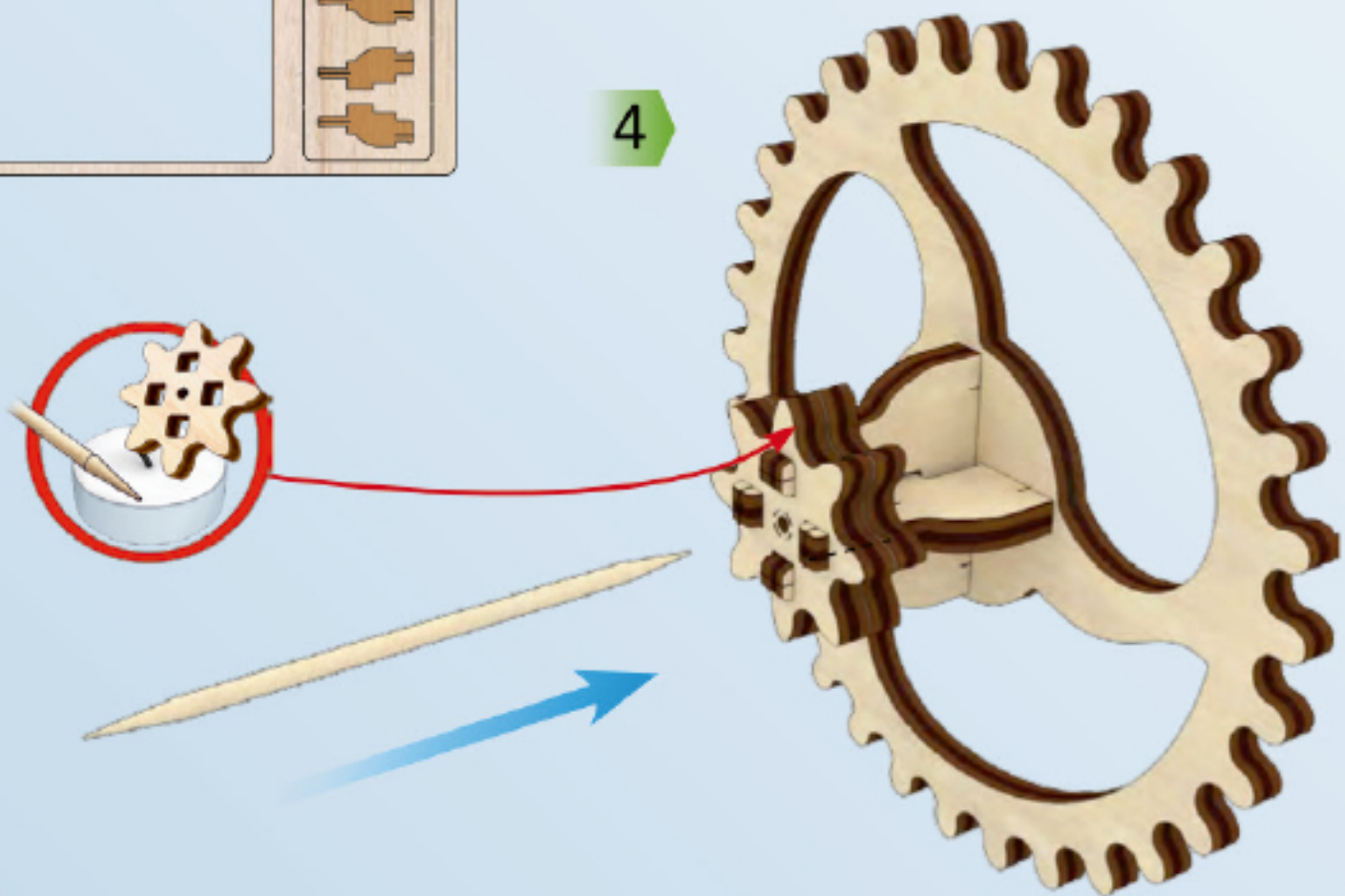
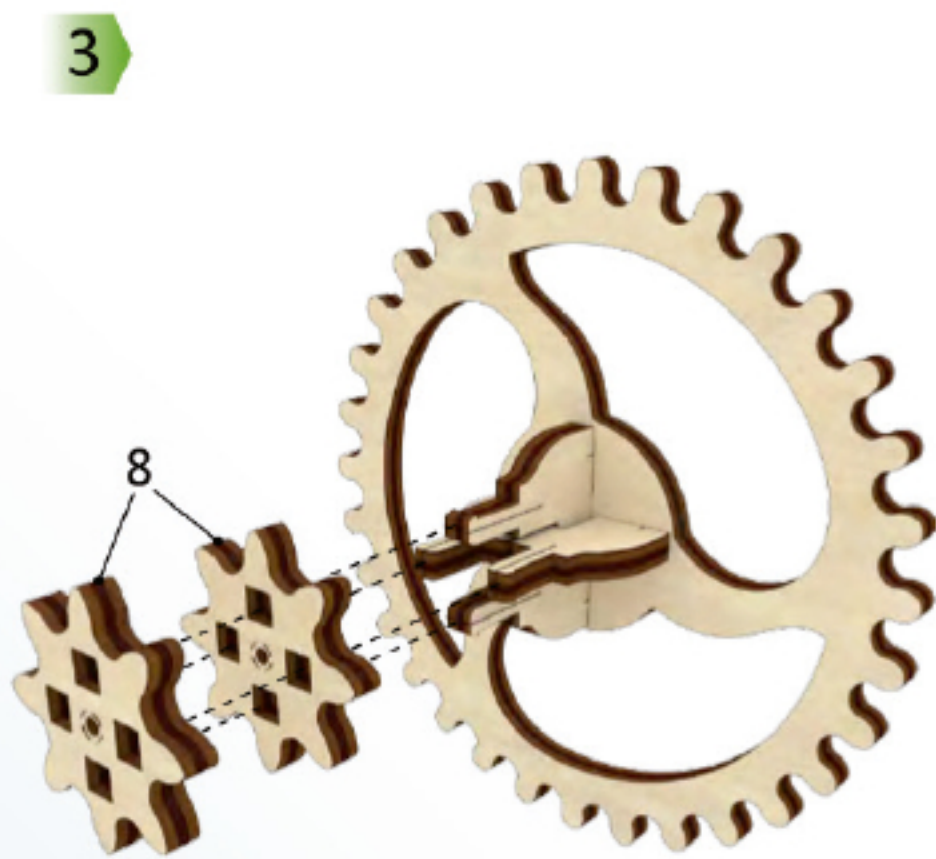
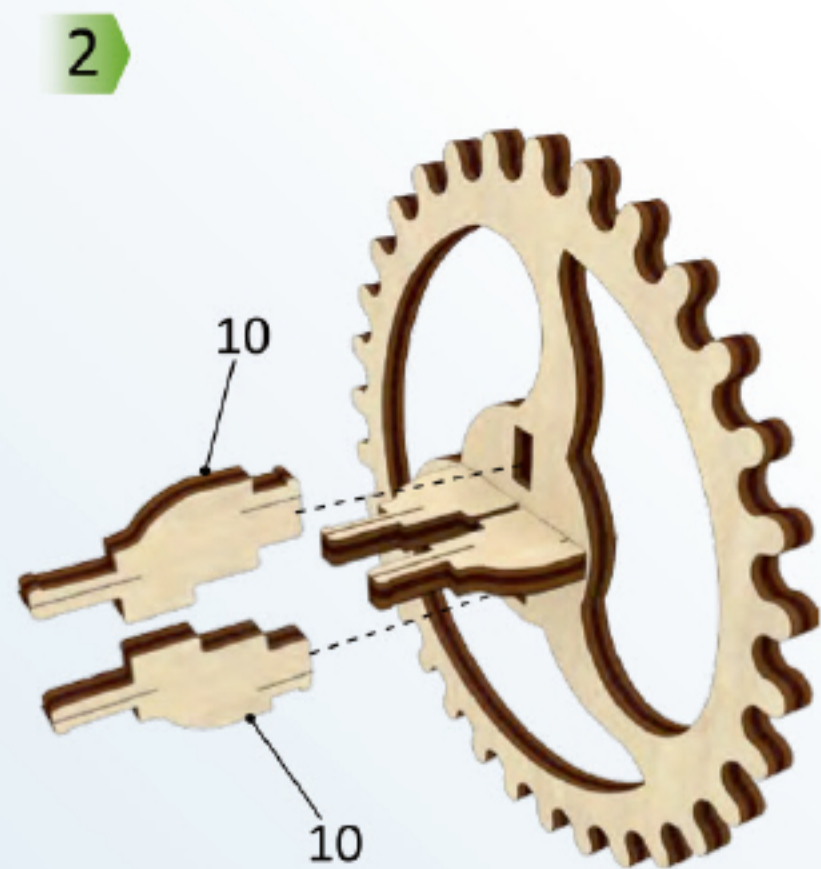
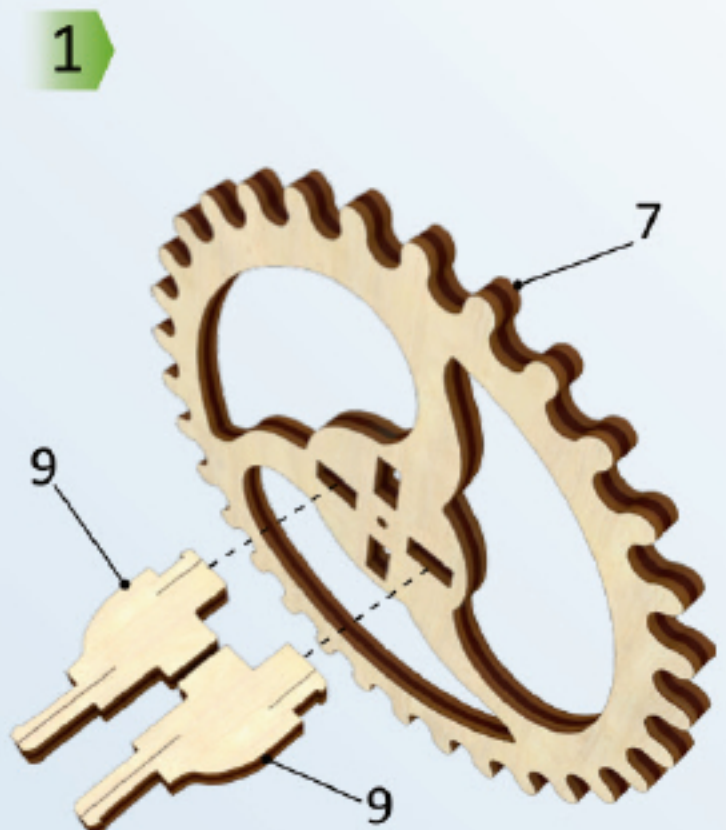
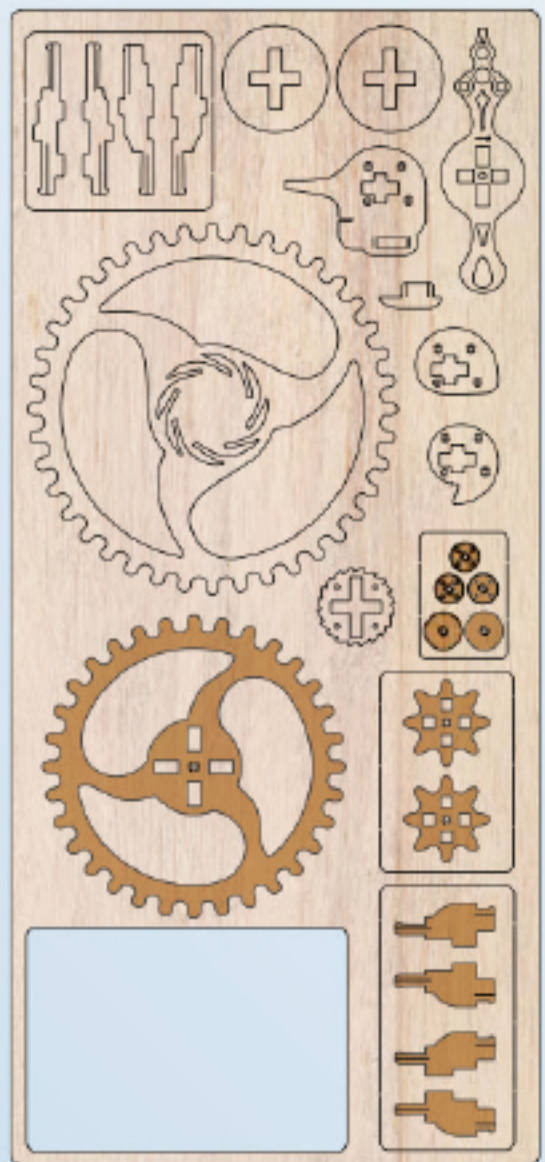

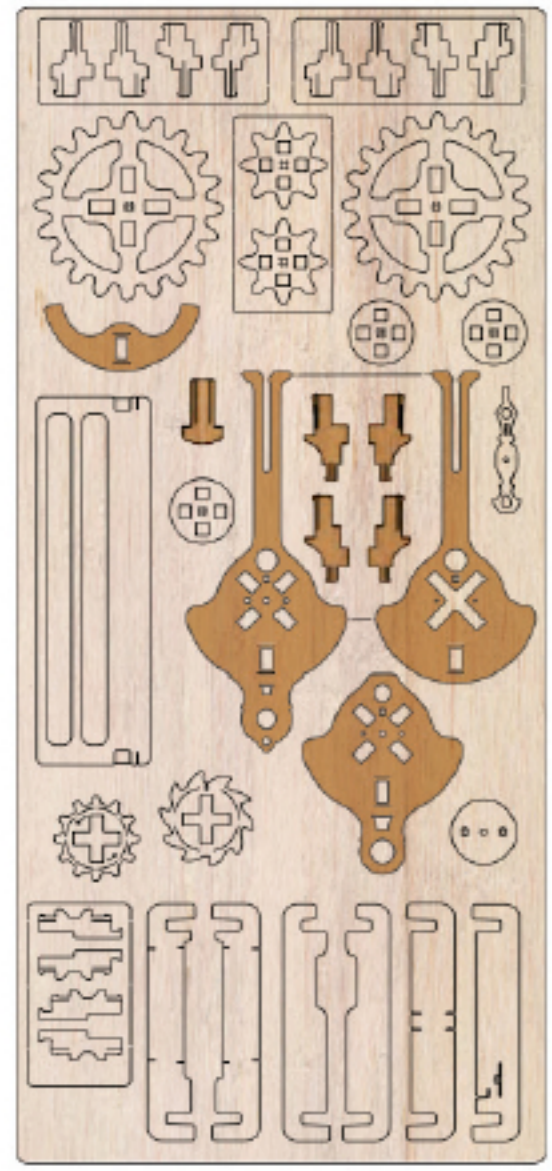

1

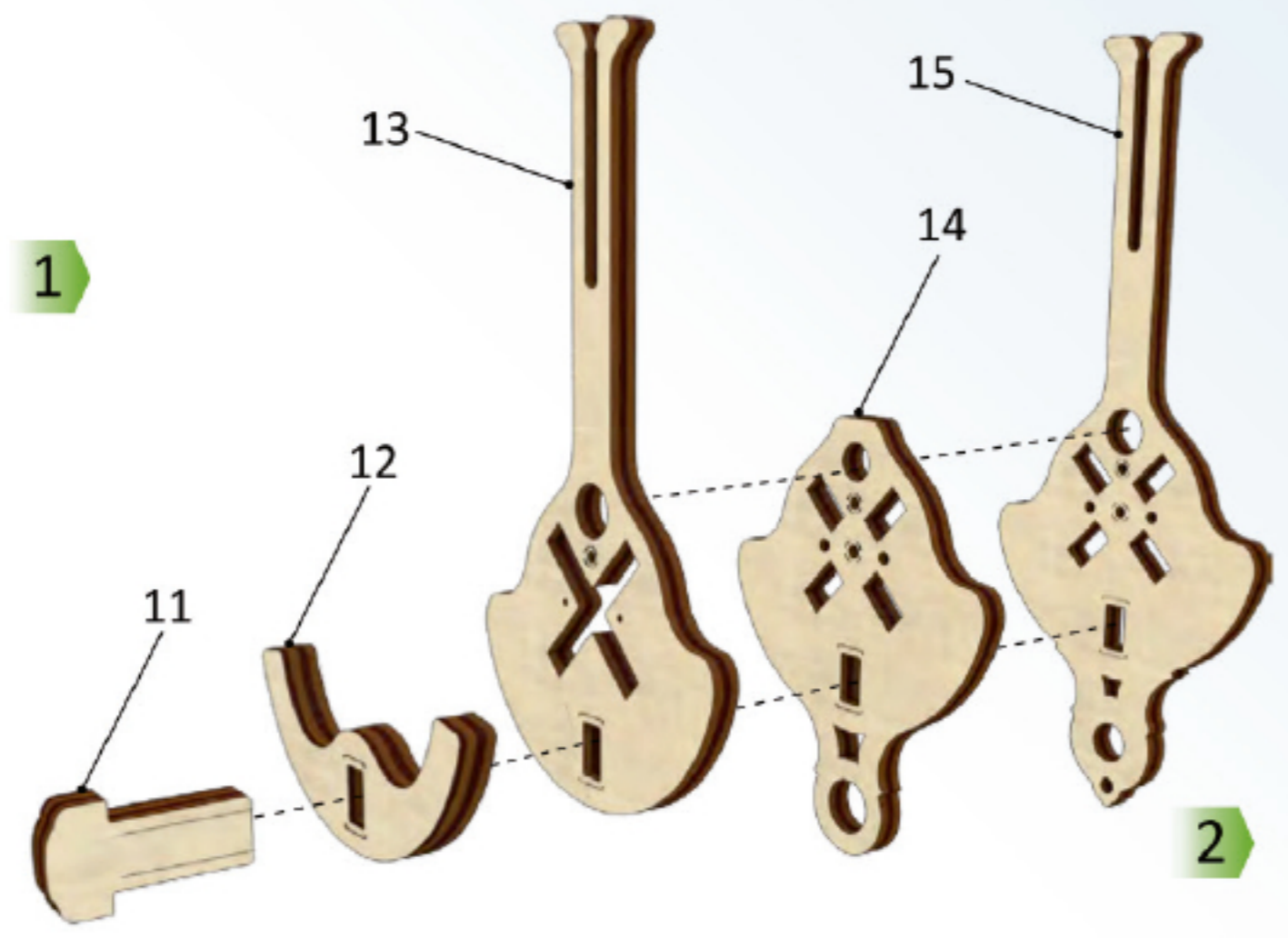

2

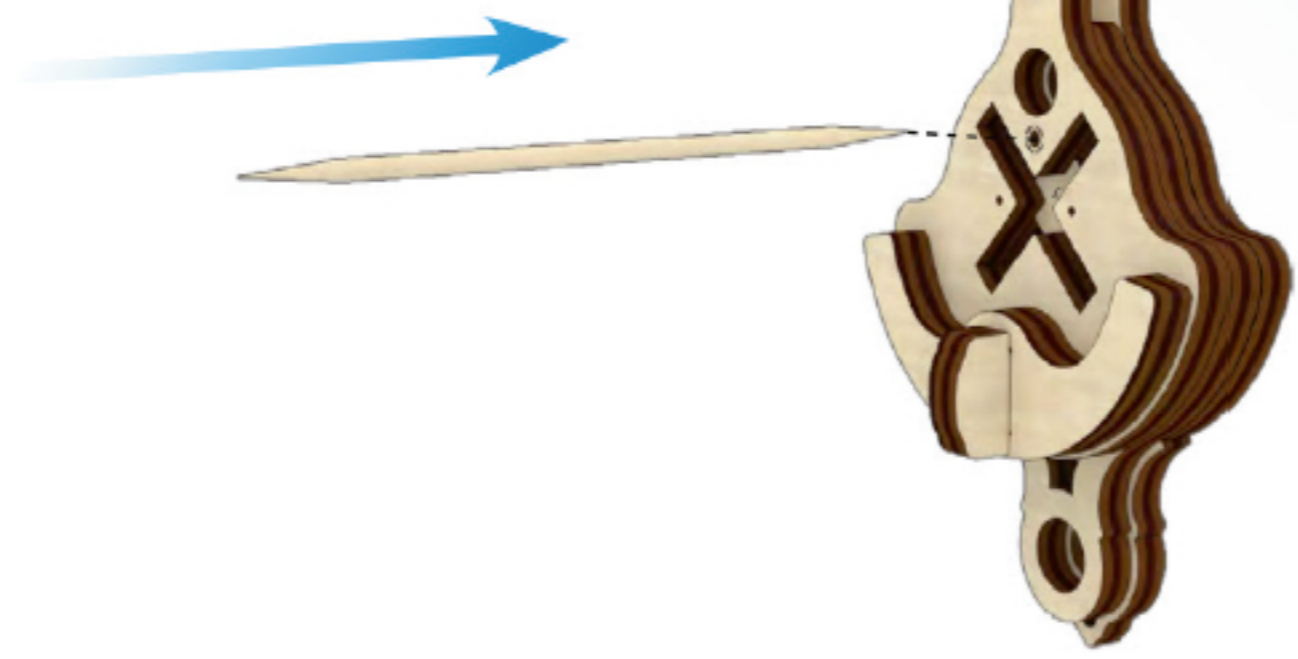

3

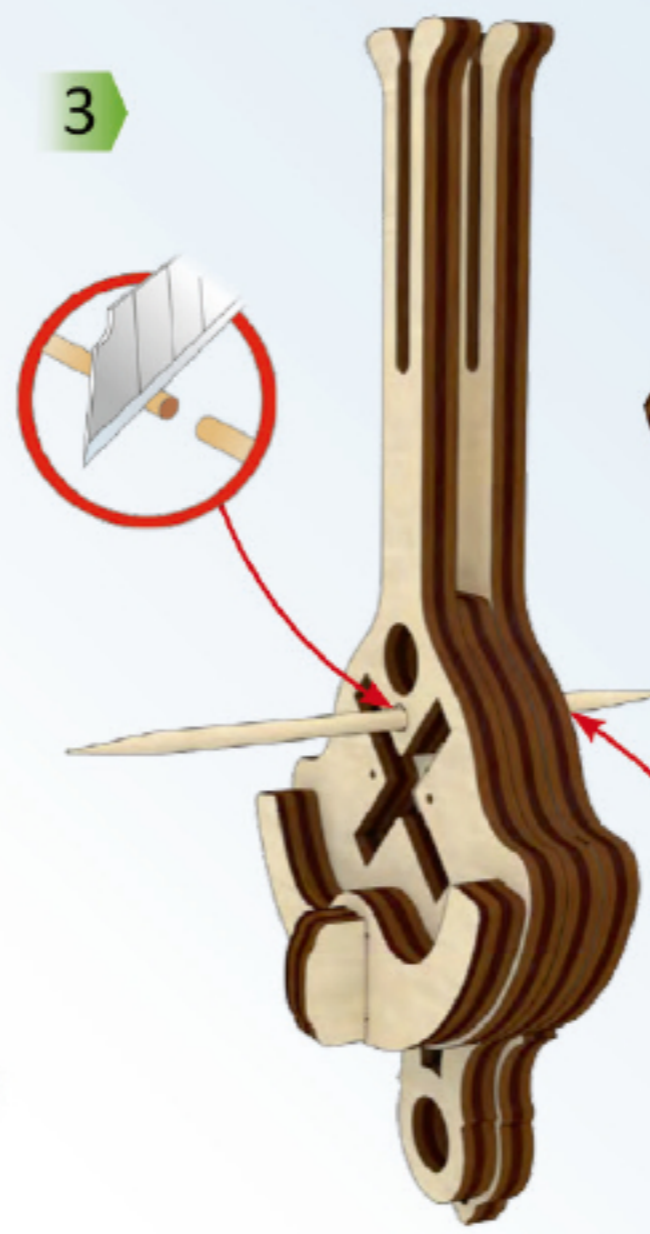

4

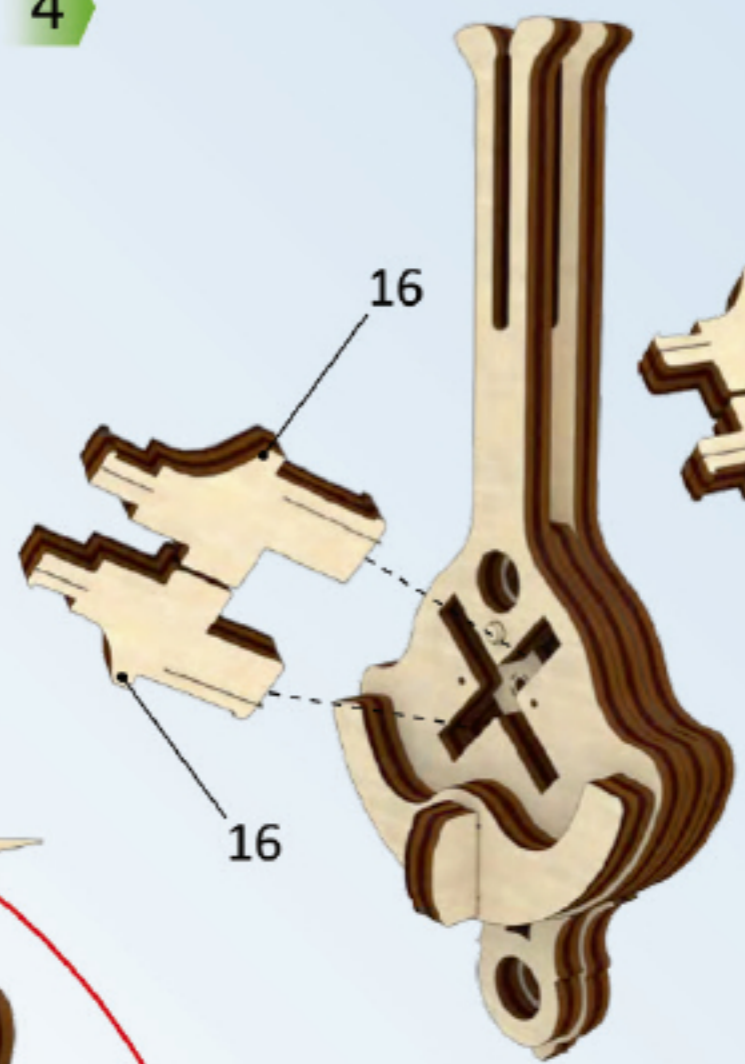

5

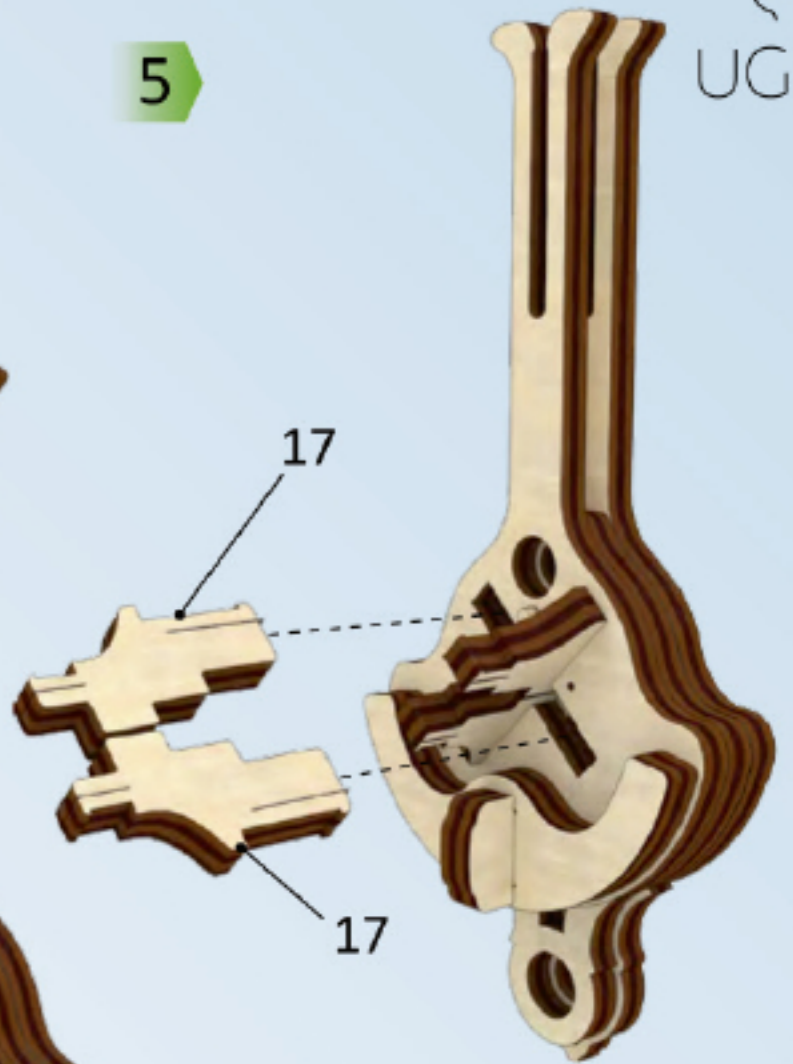

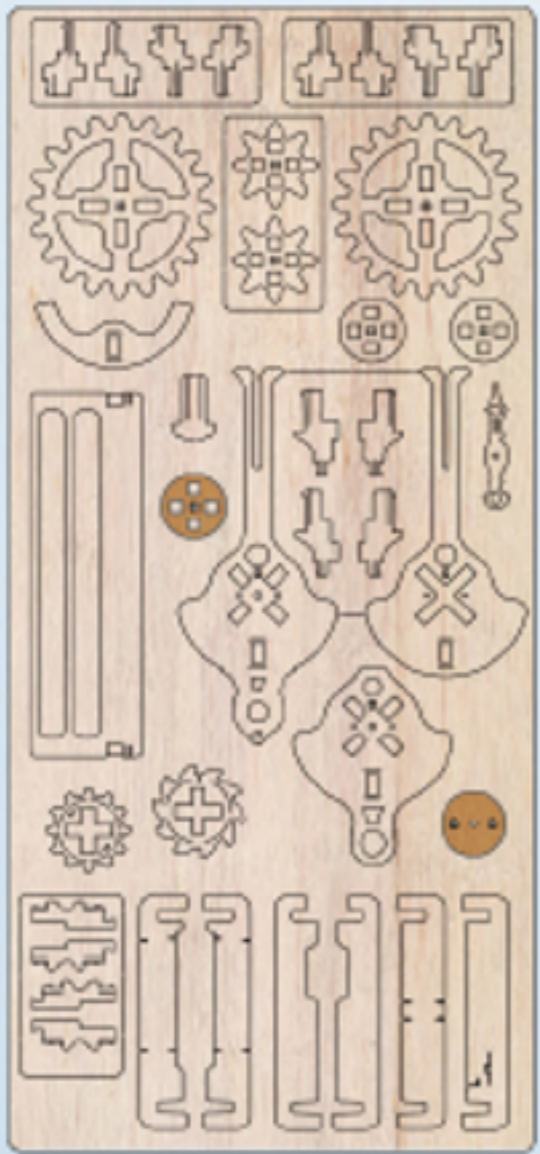

6



7

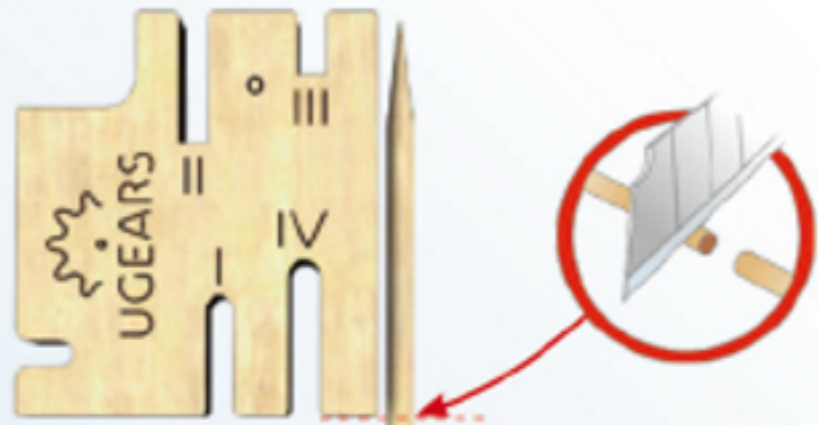

8

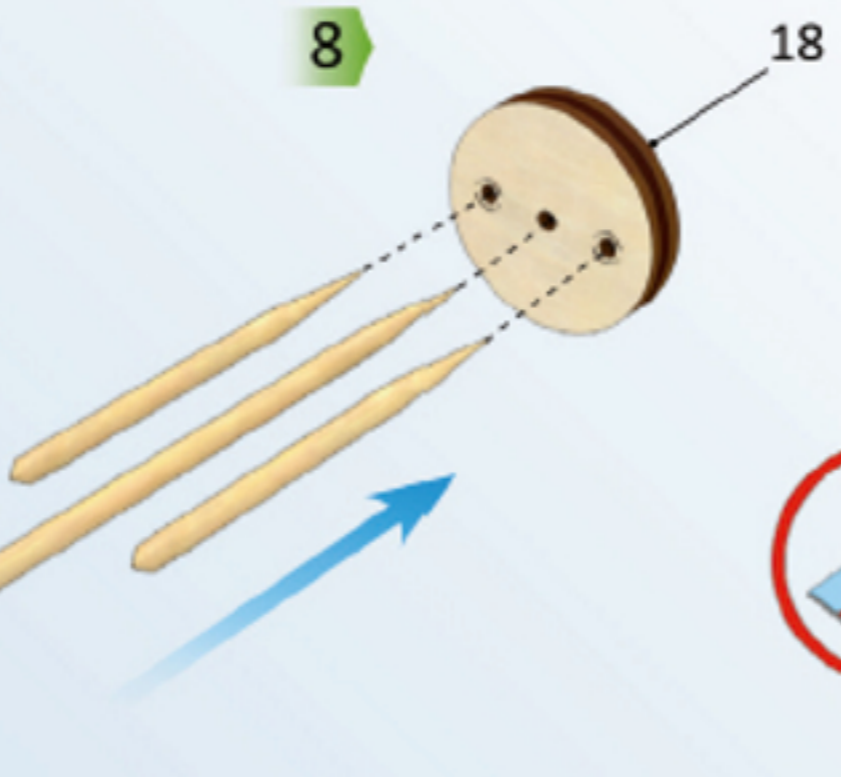

9

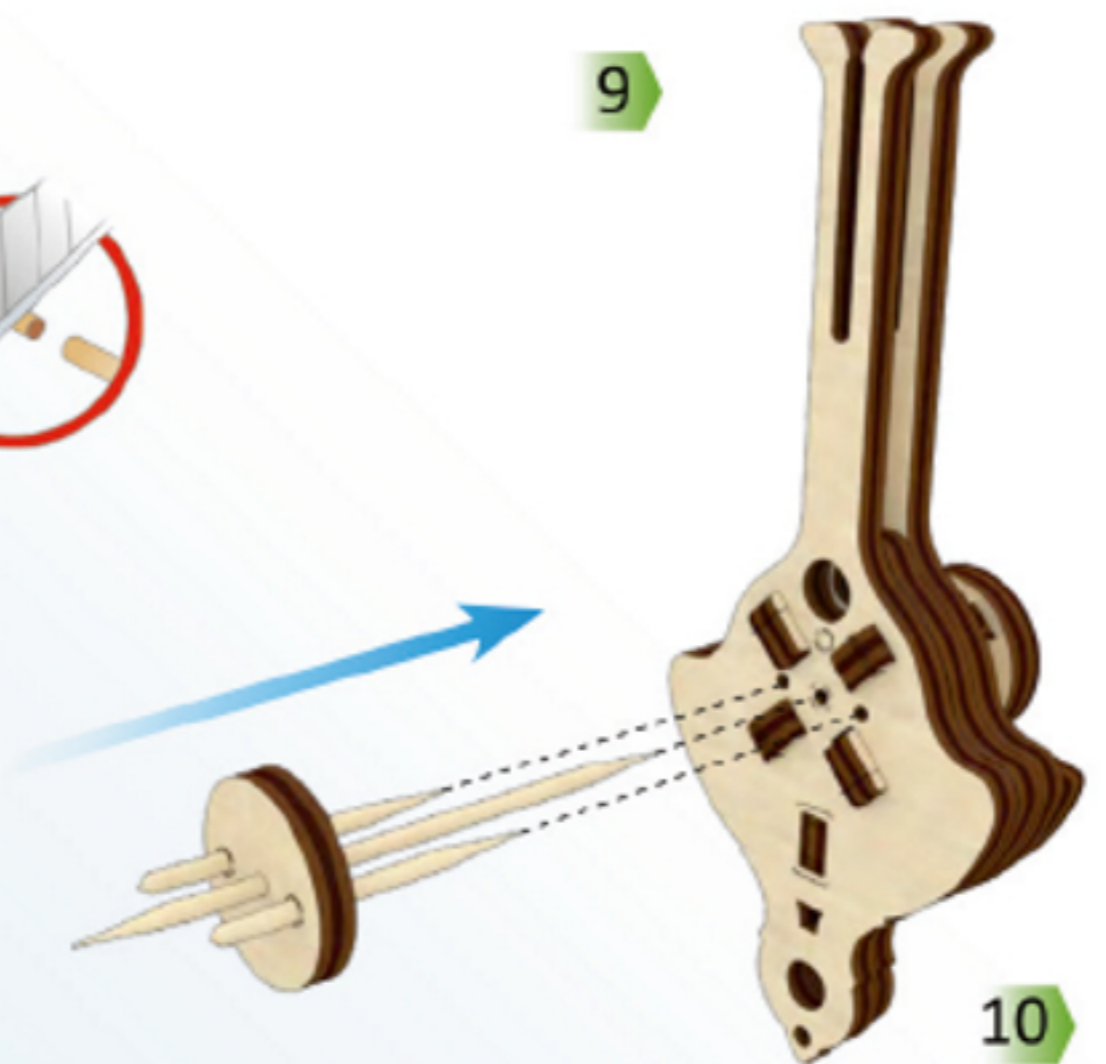

10



11

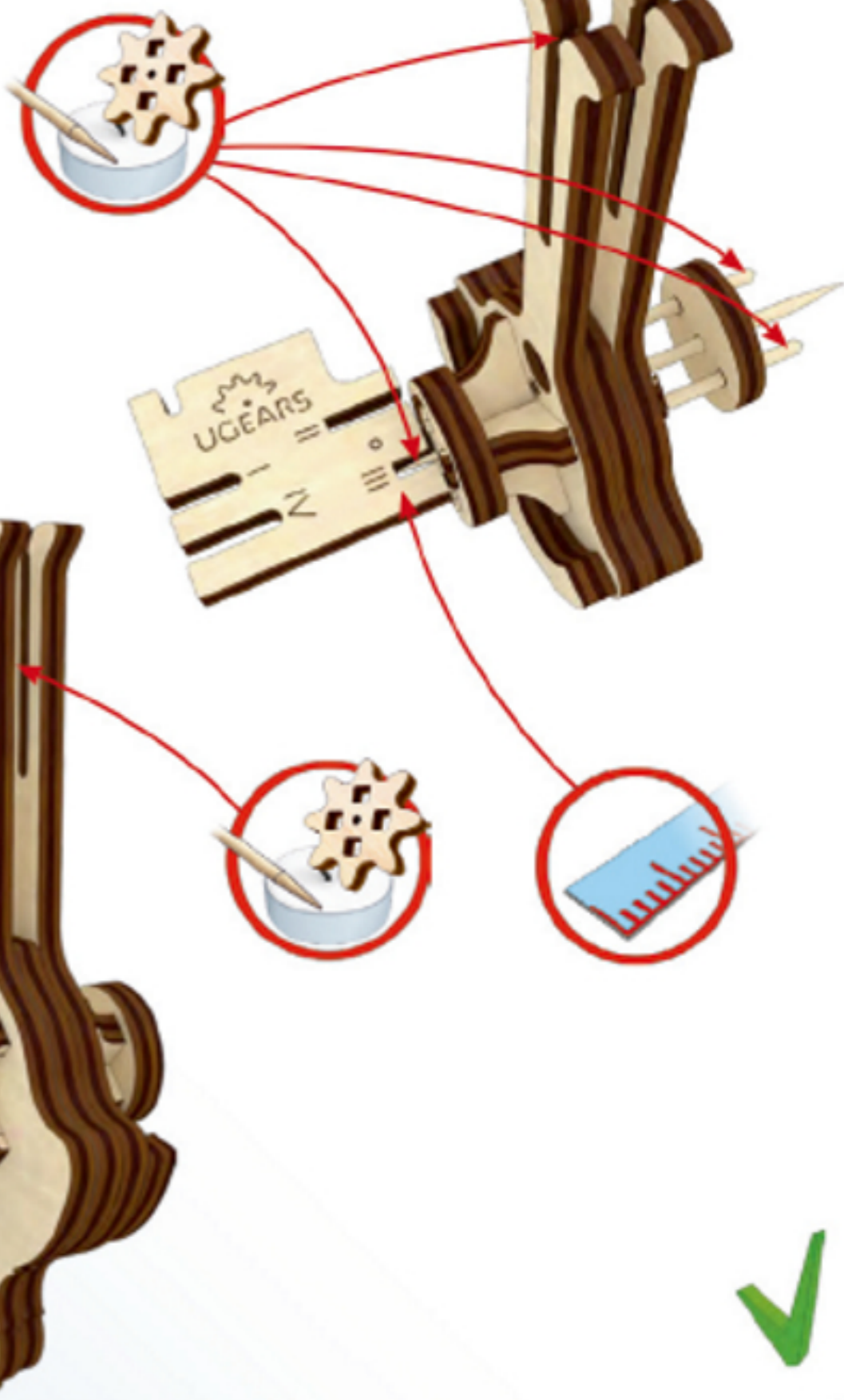





1

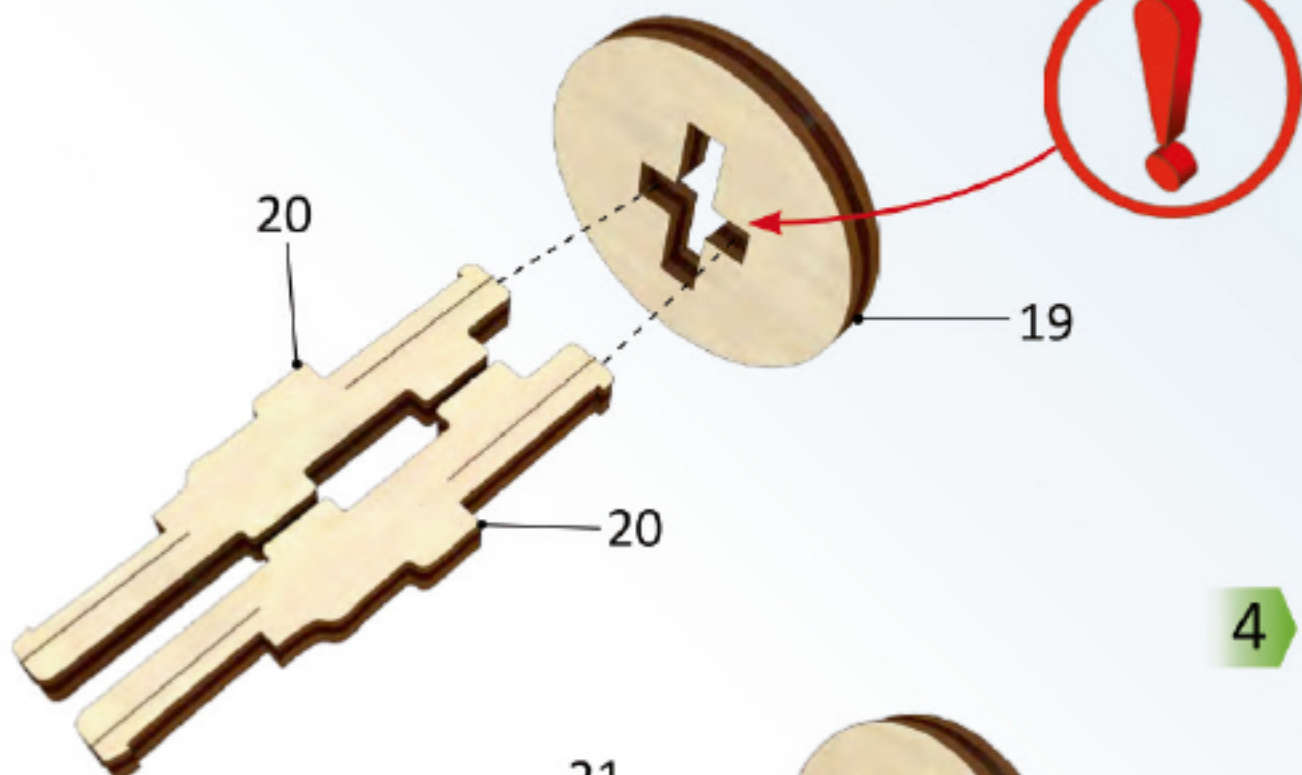

2

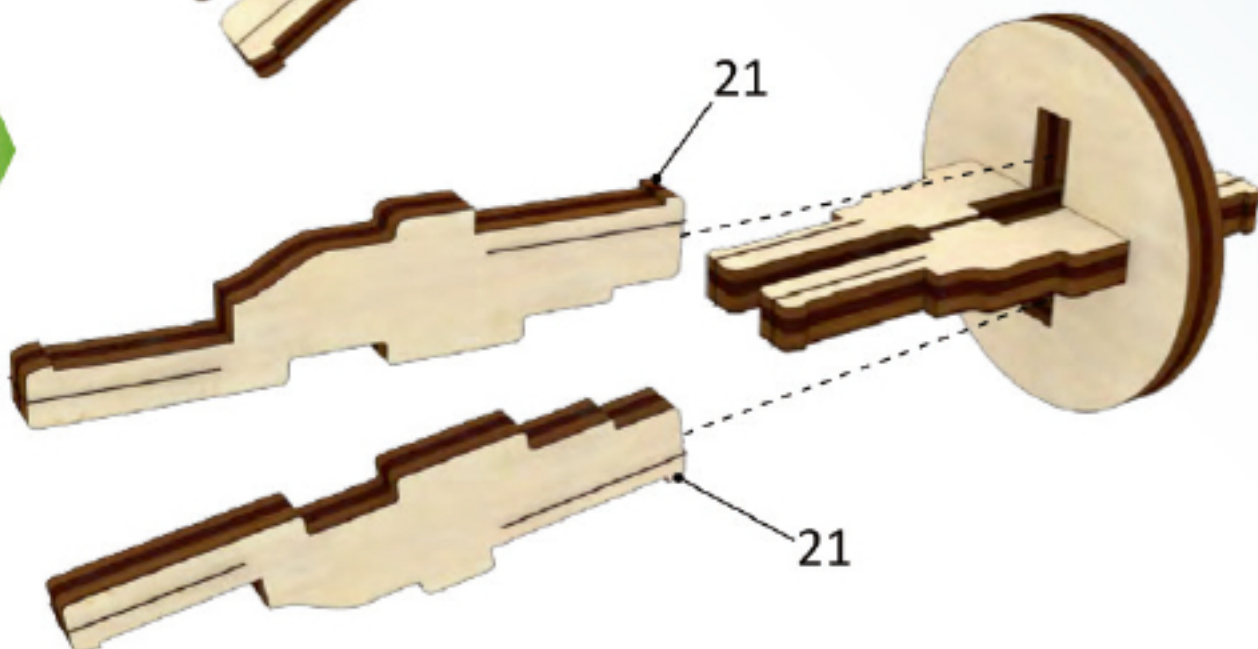

3

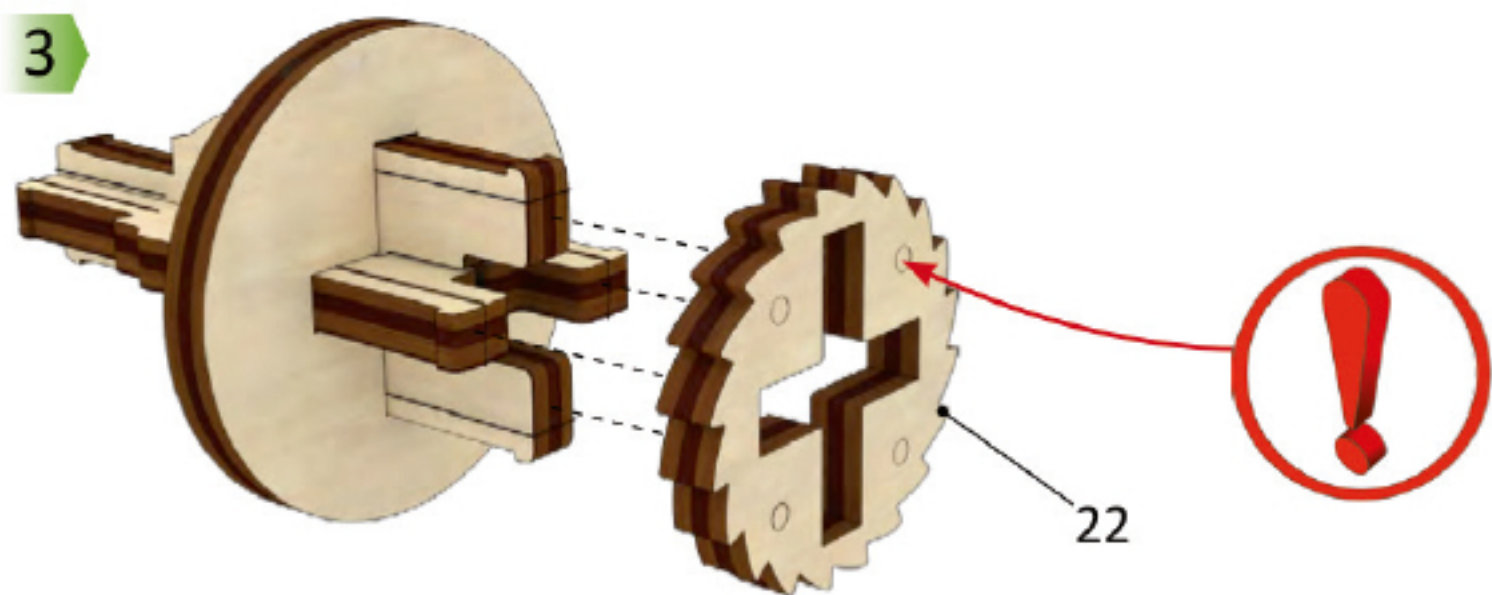

4

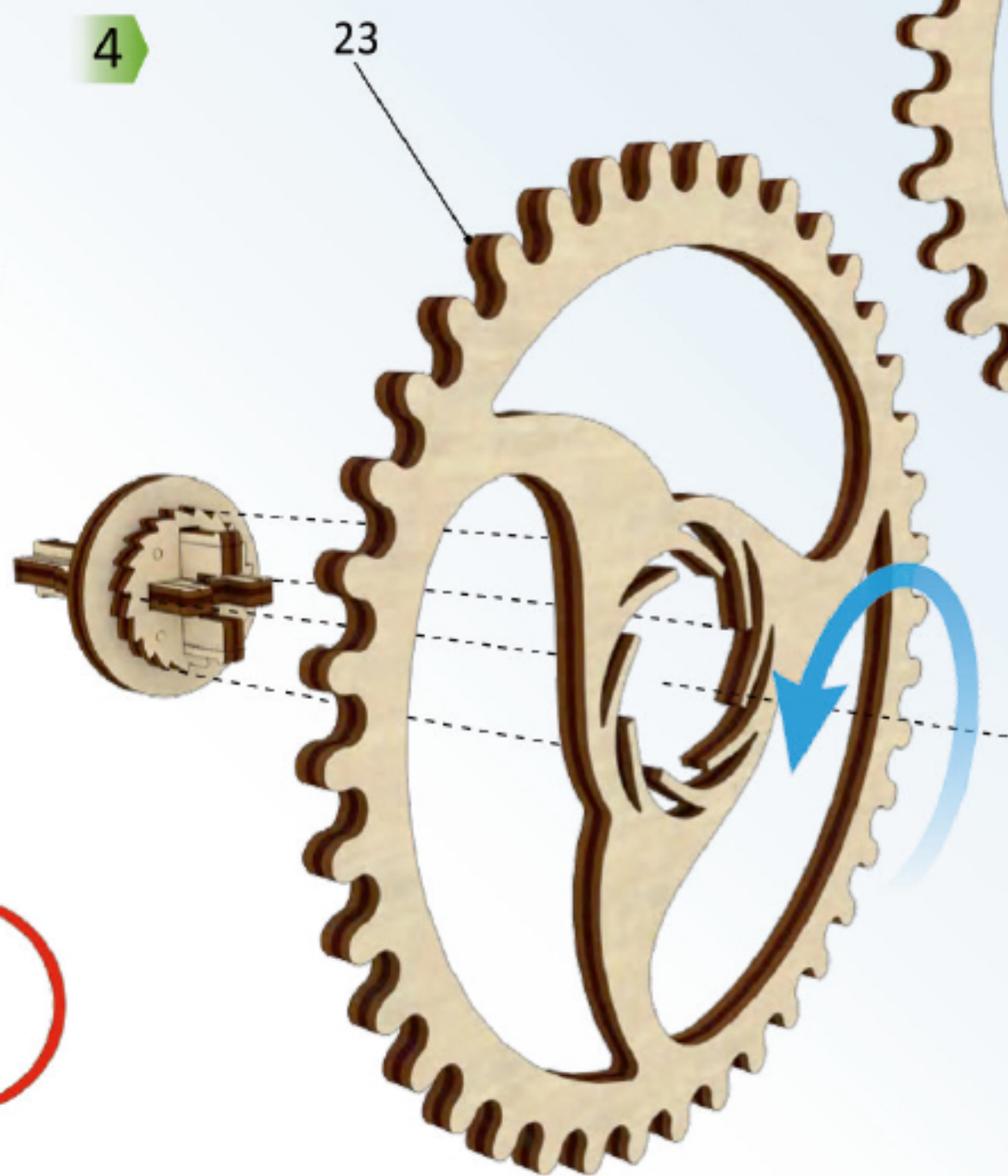

5

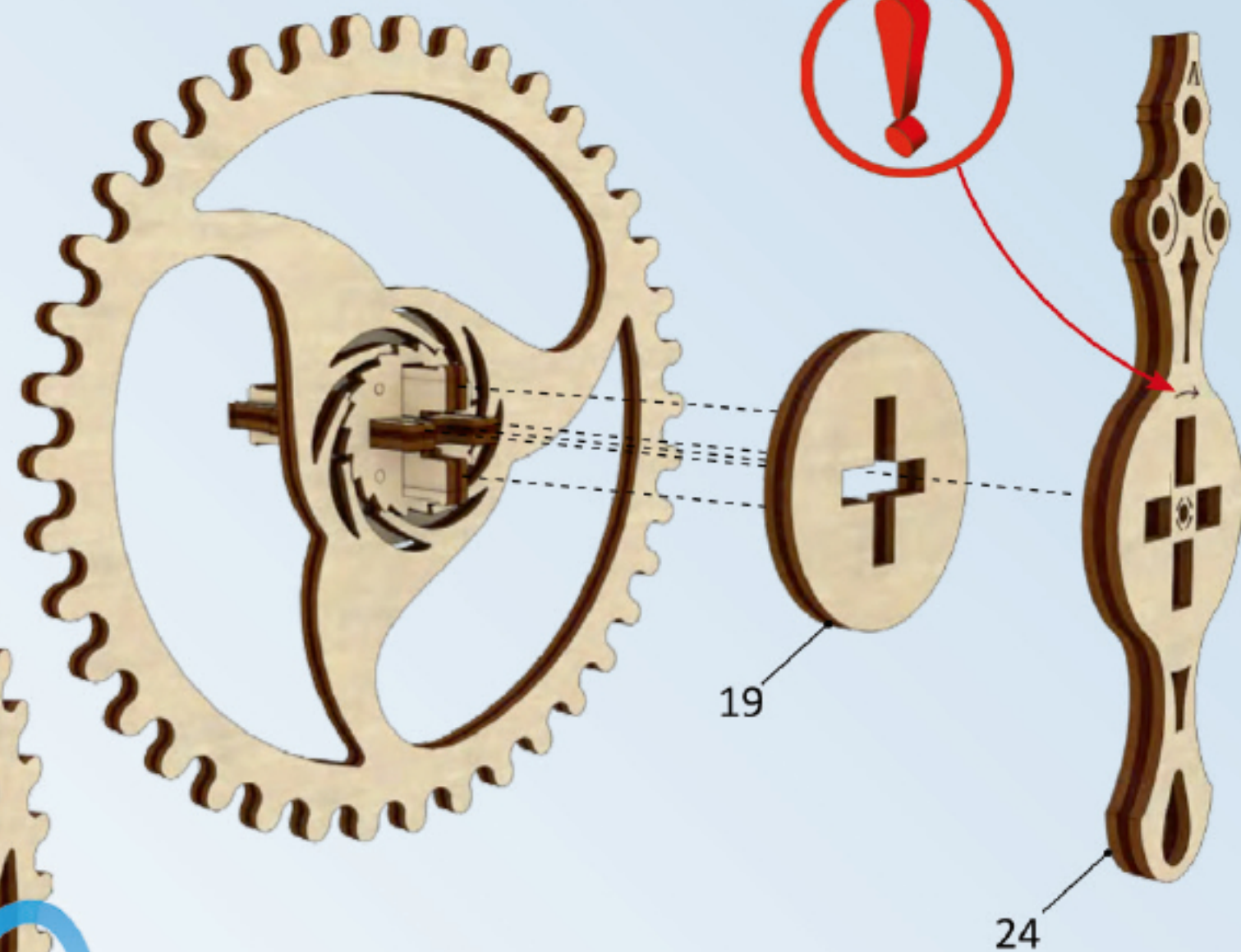

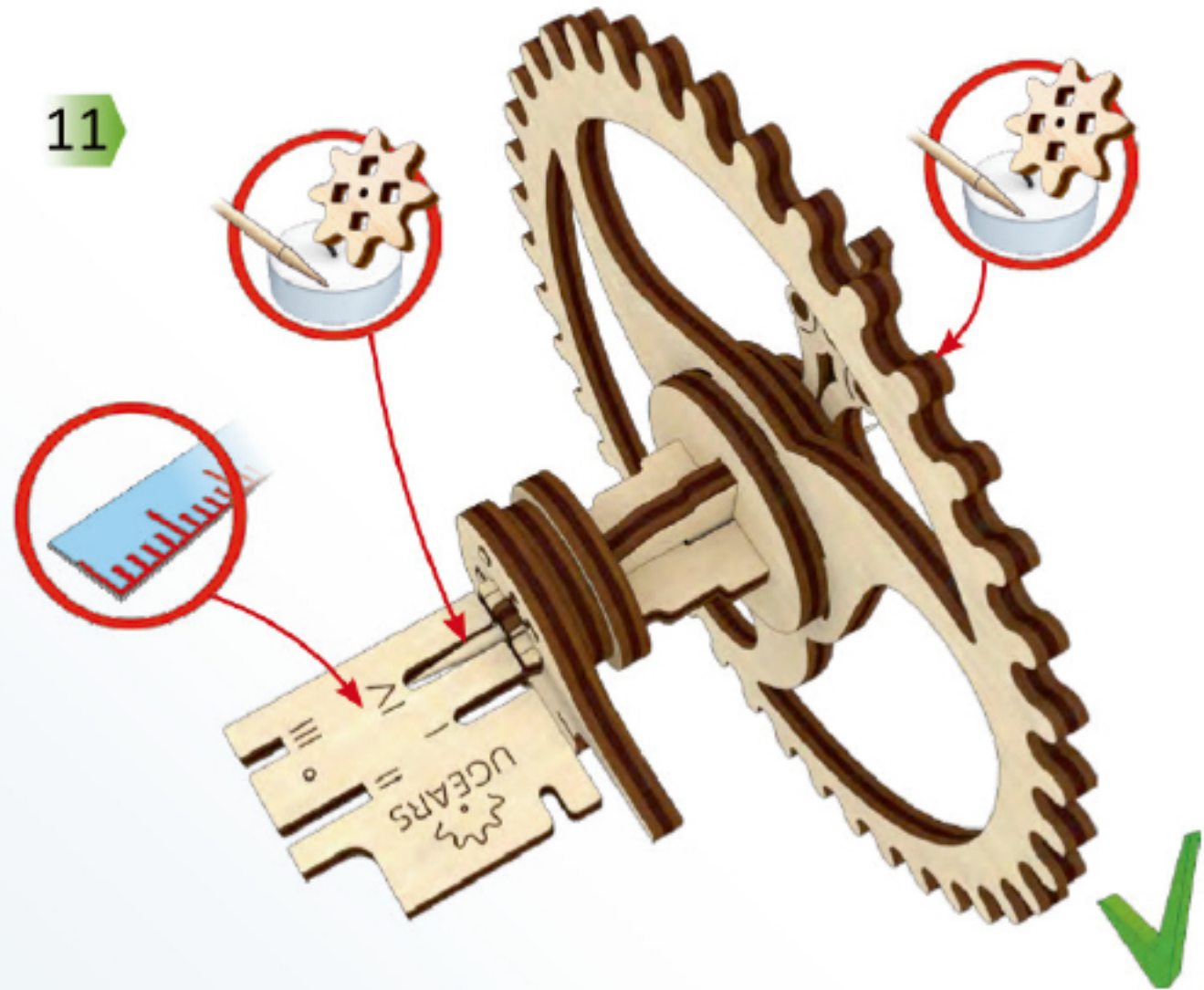
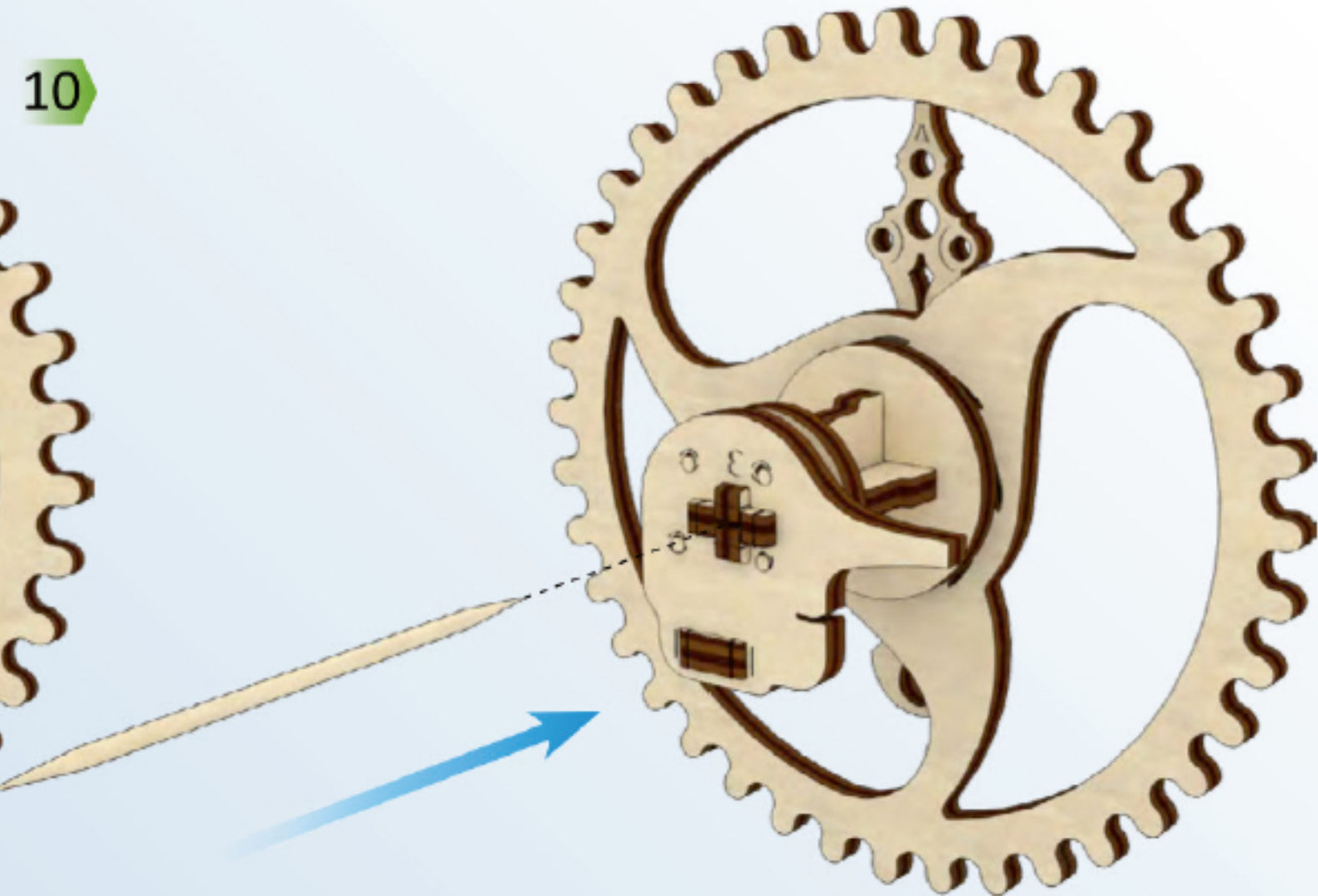
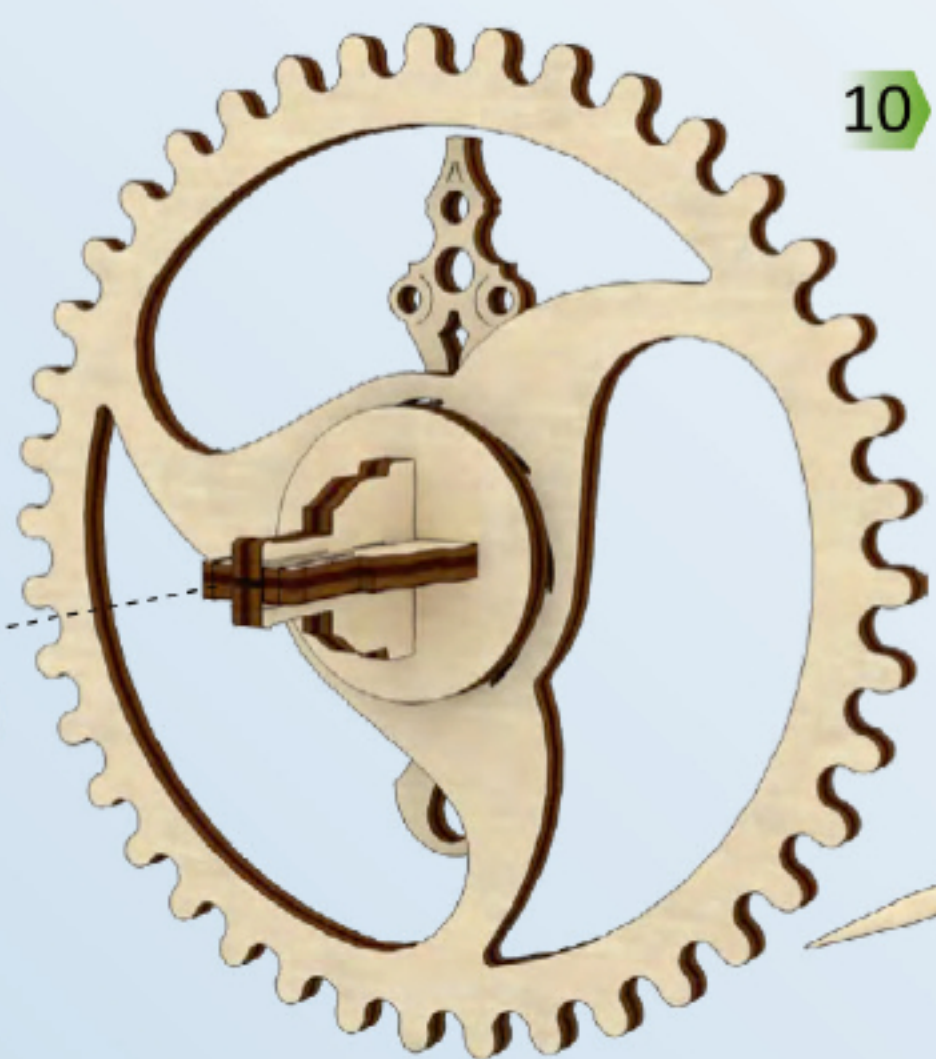
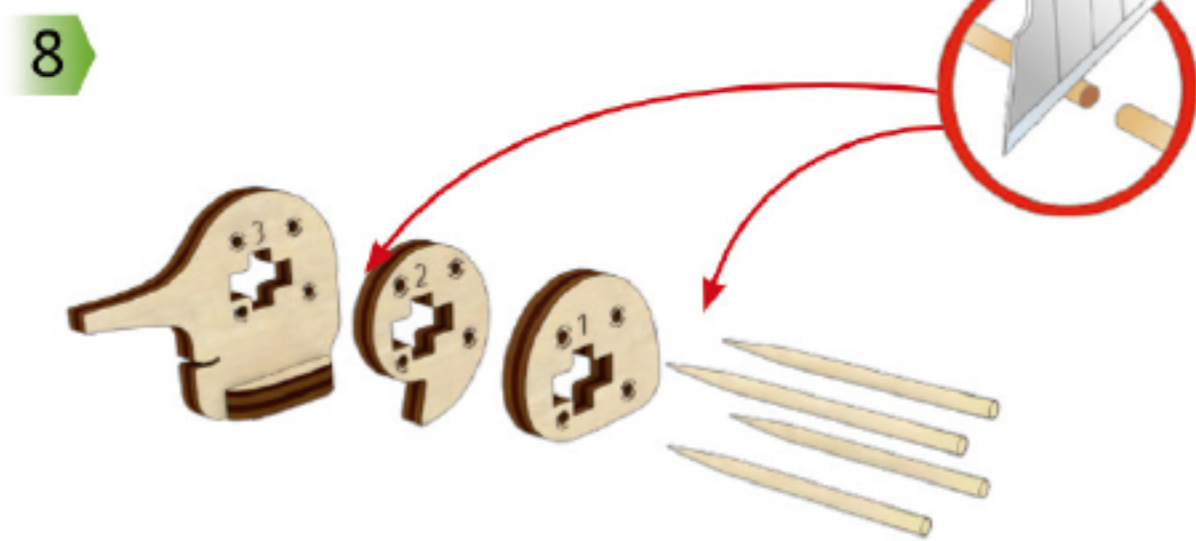
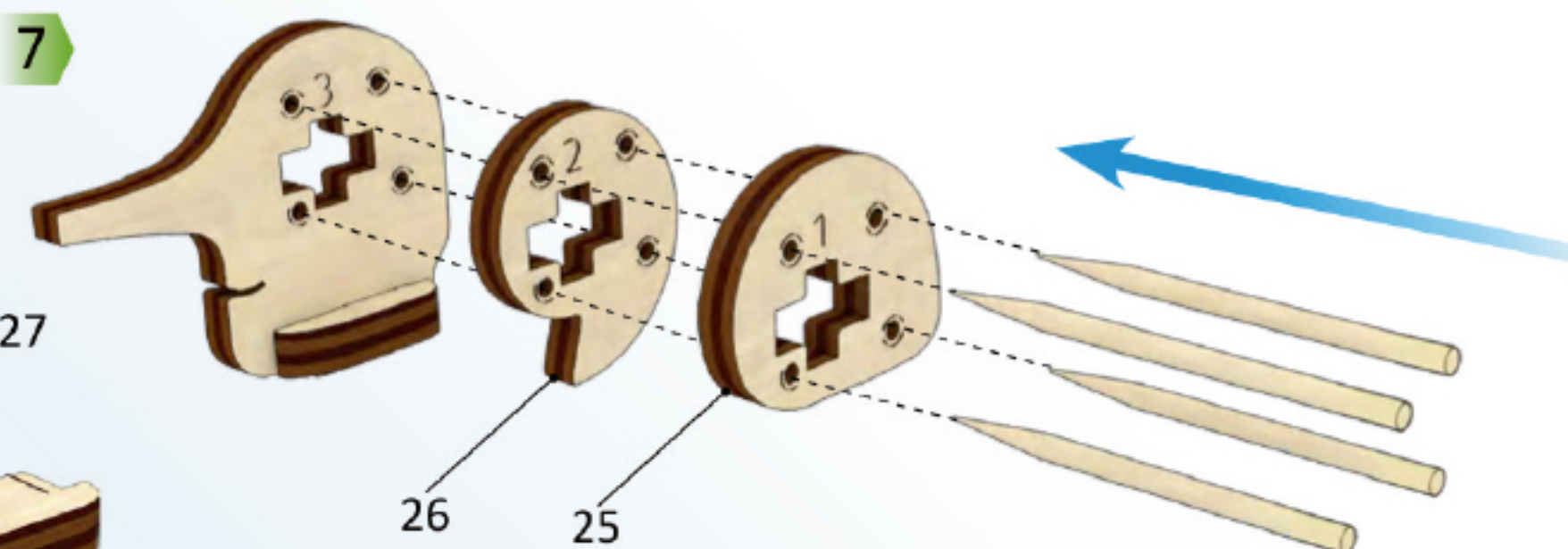
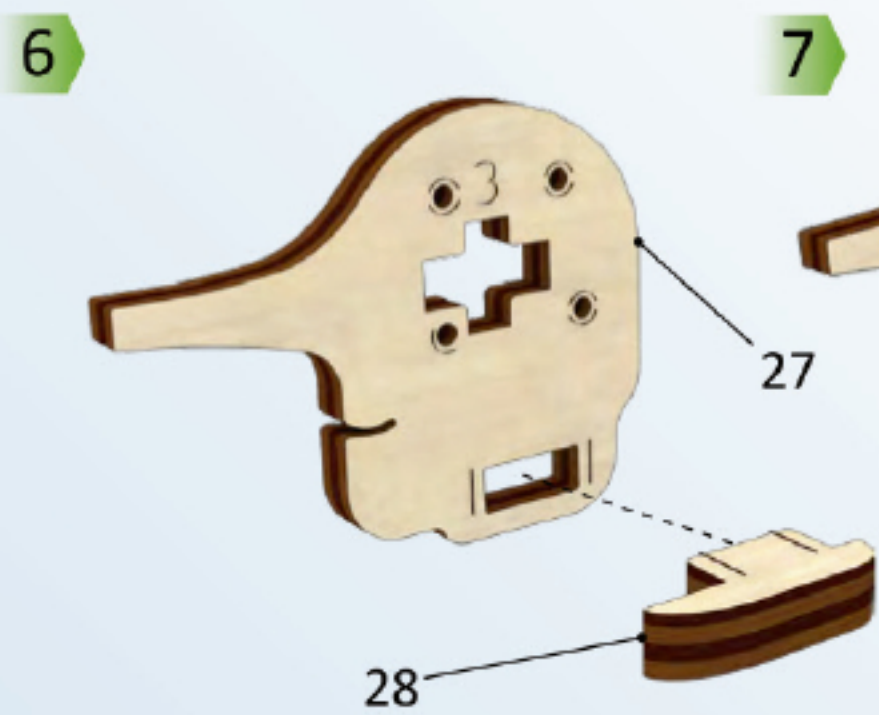
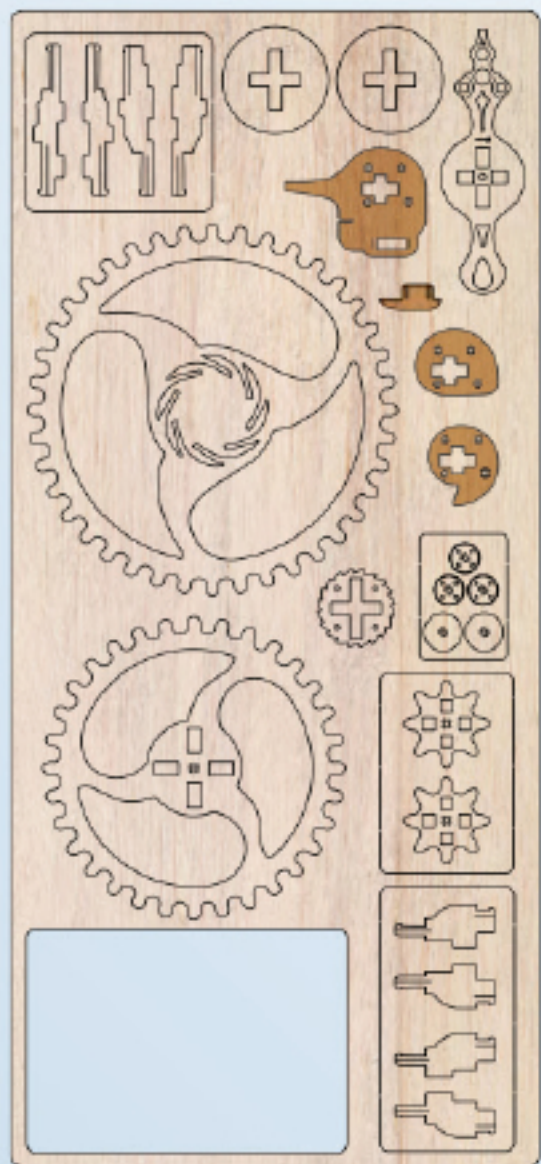

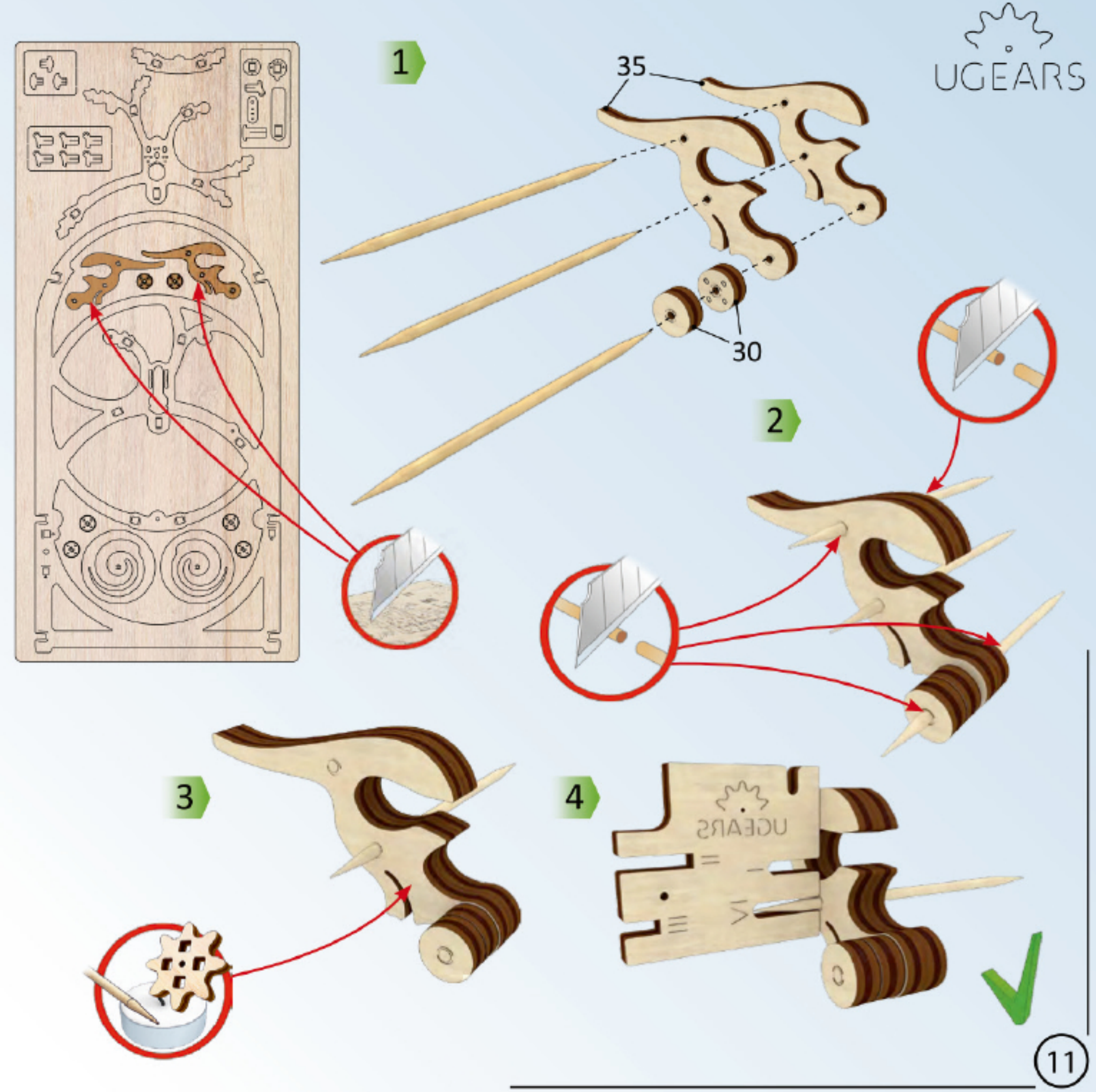
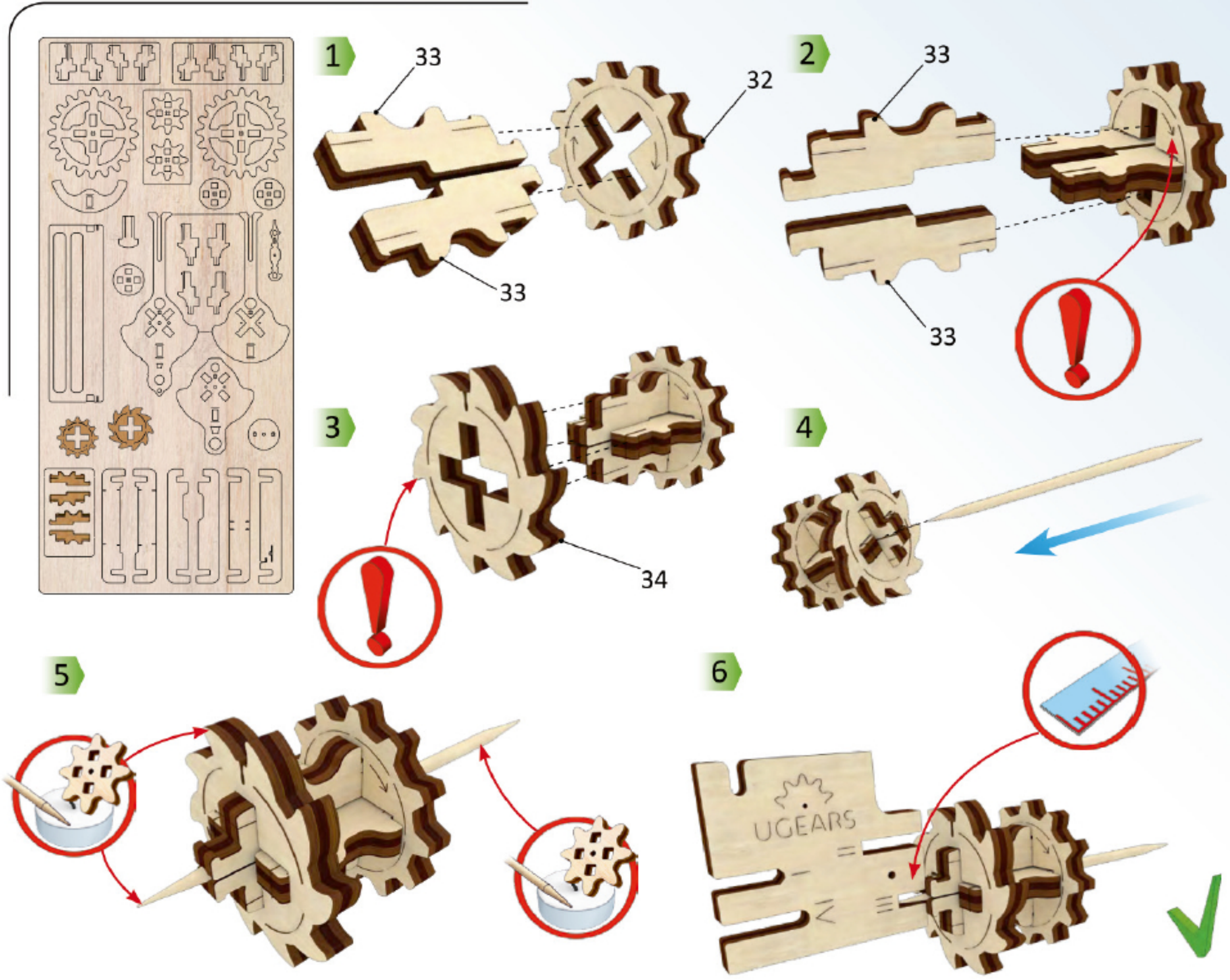

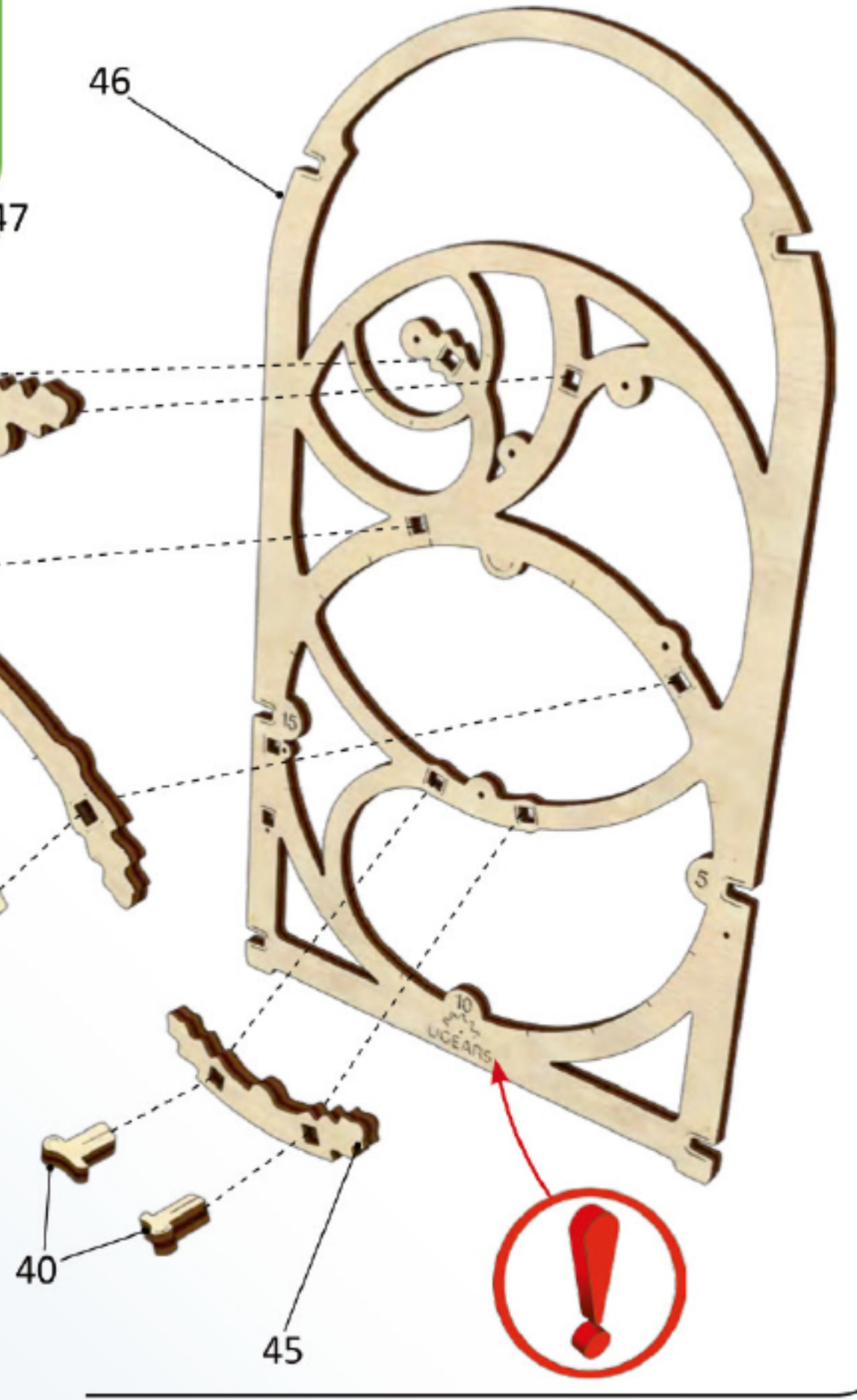
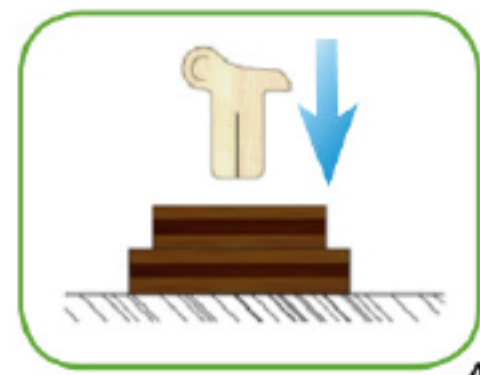
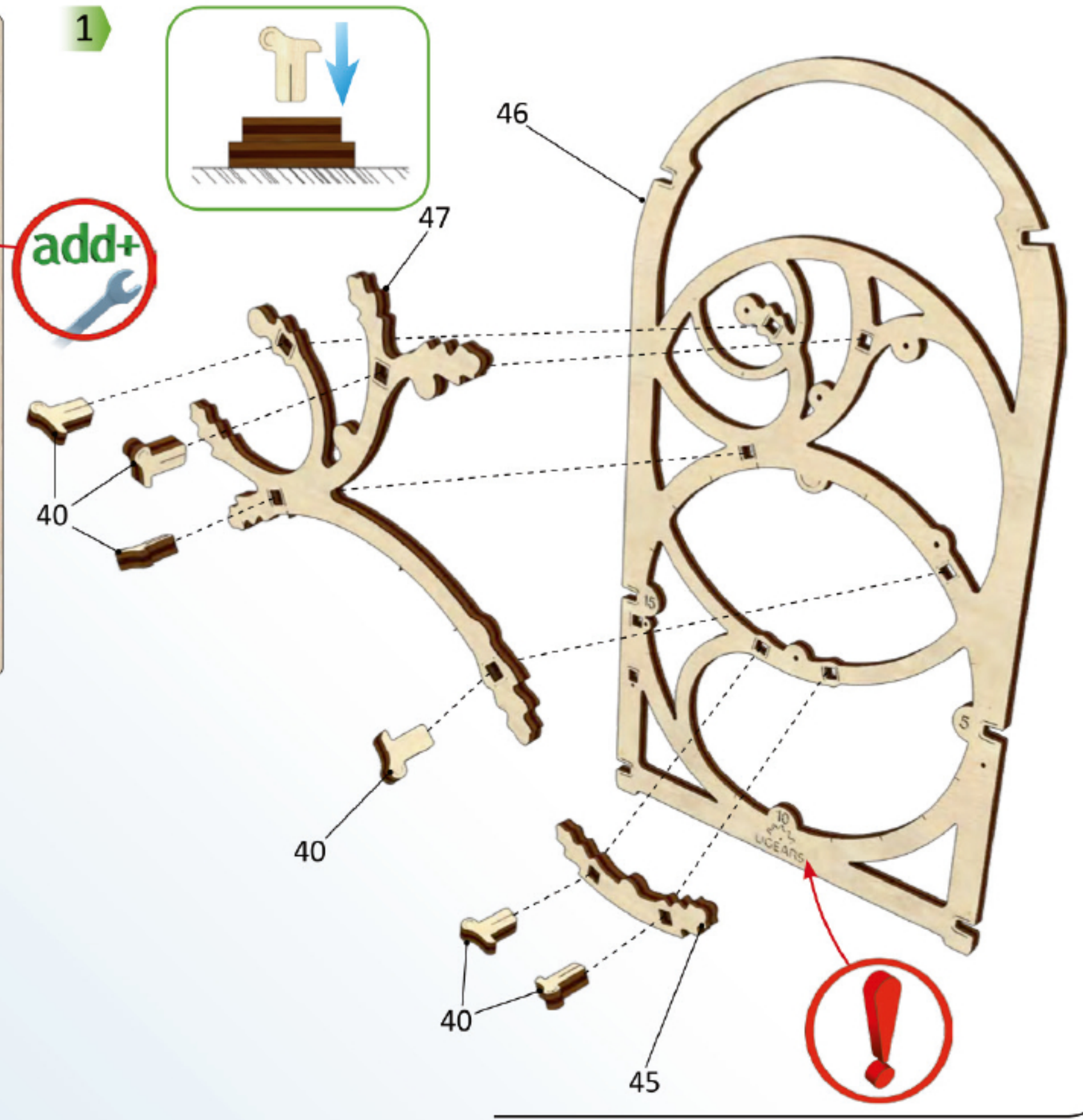
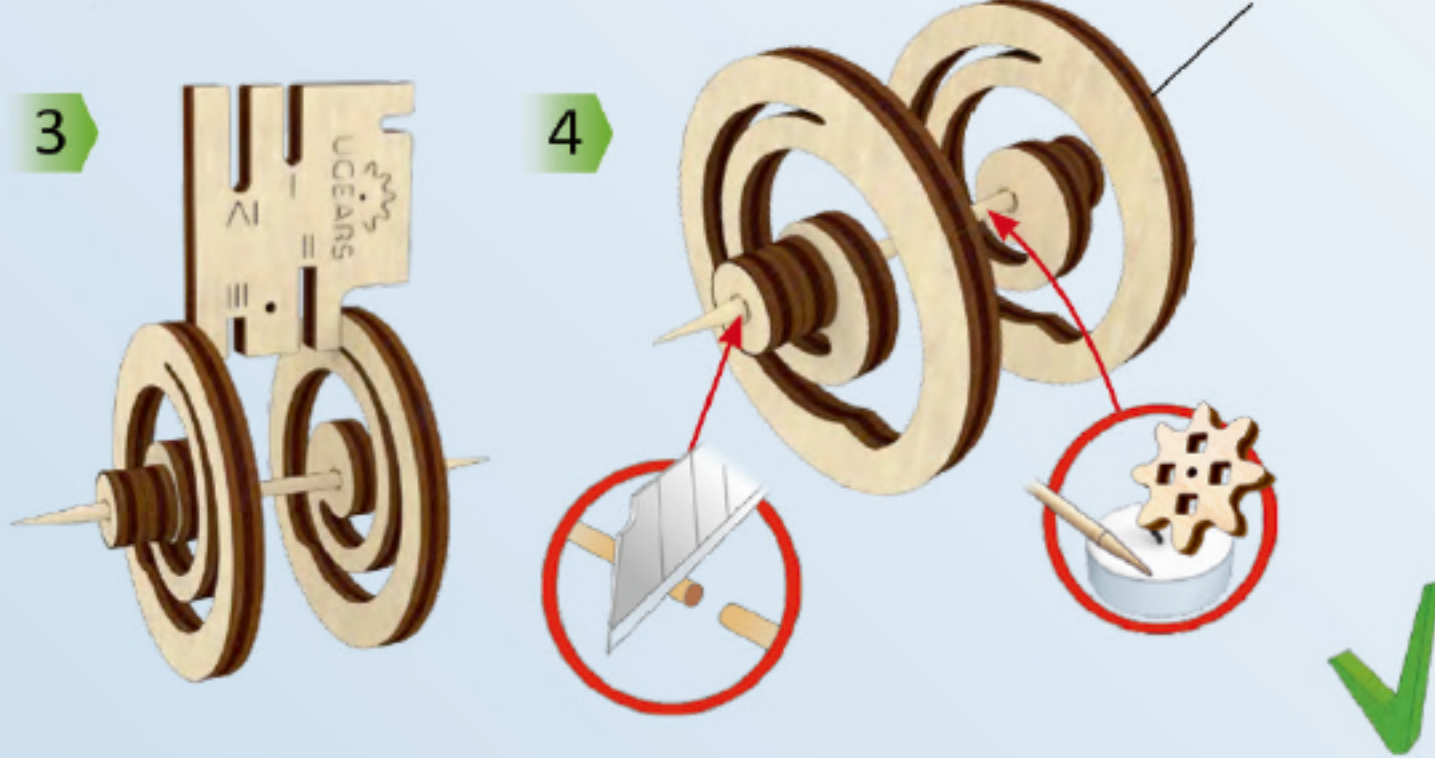
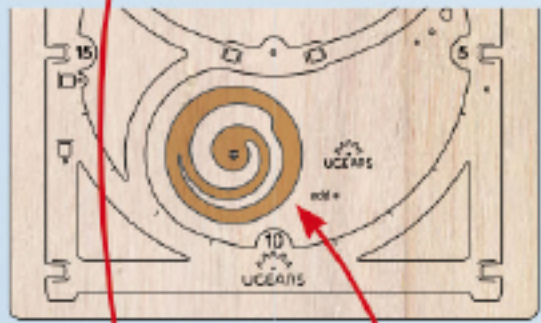
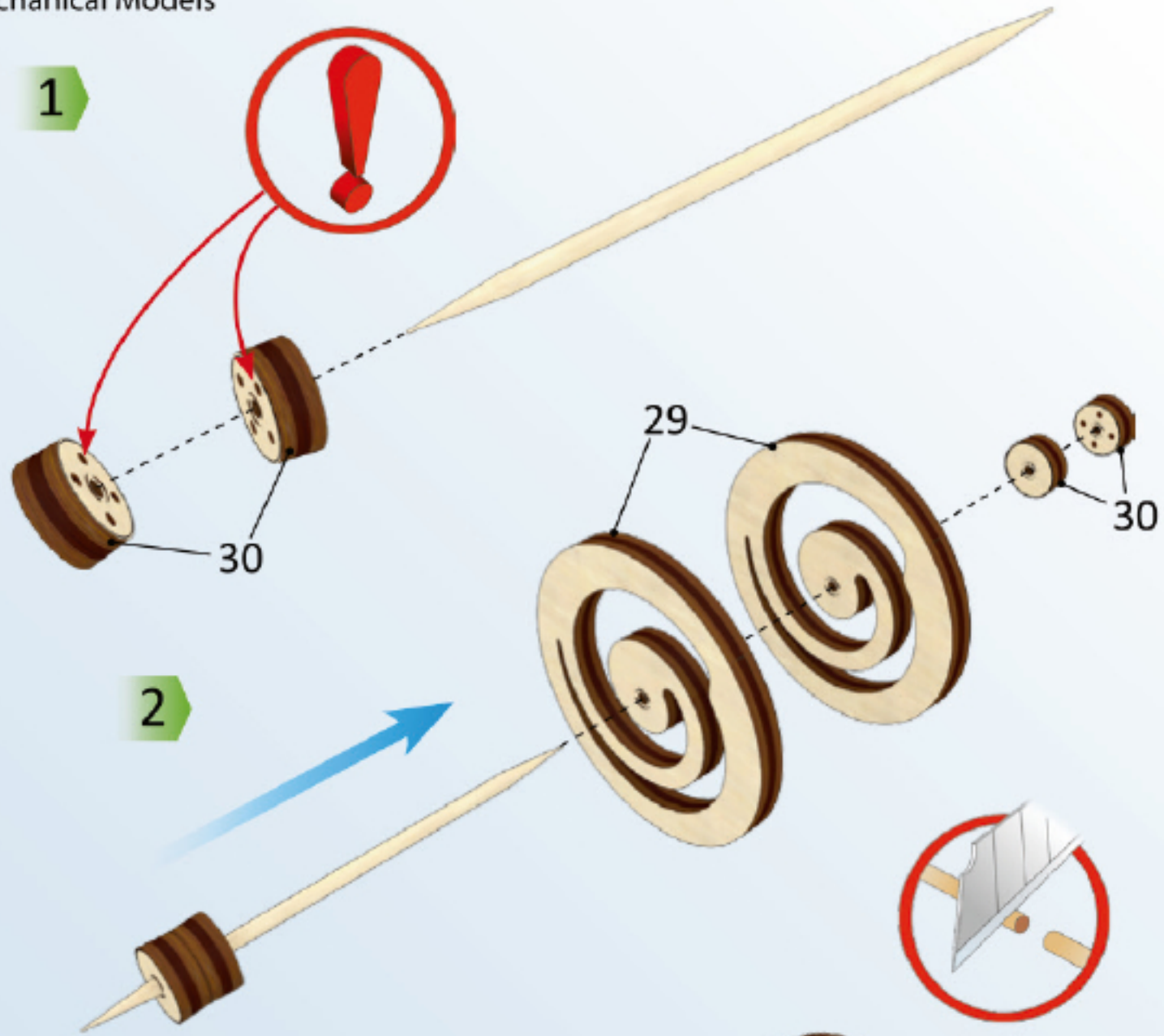

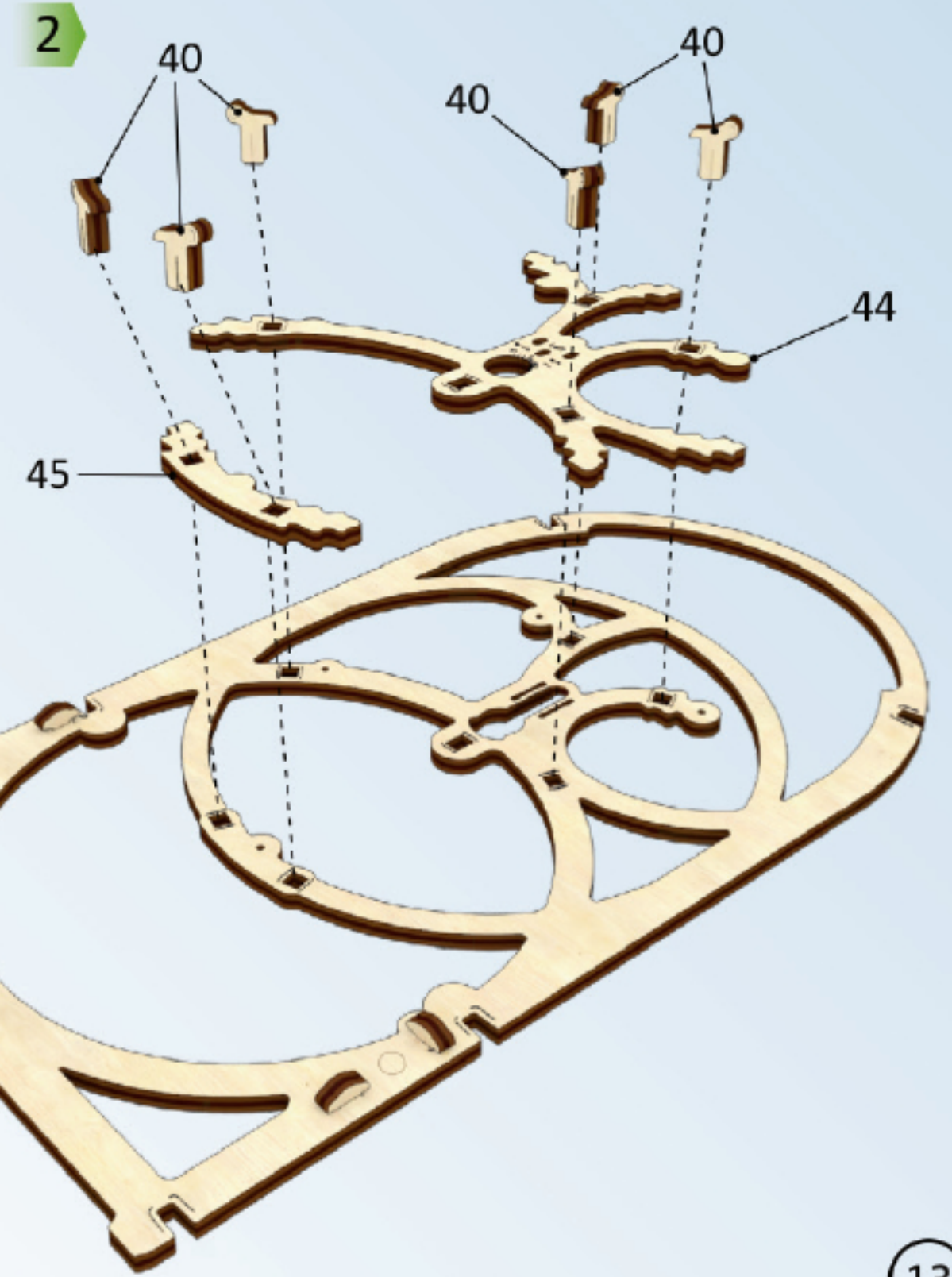
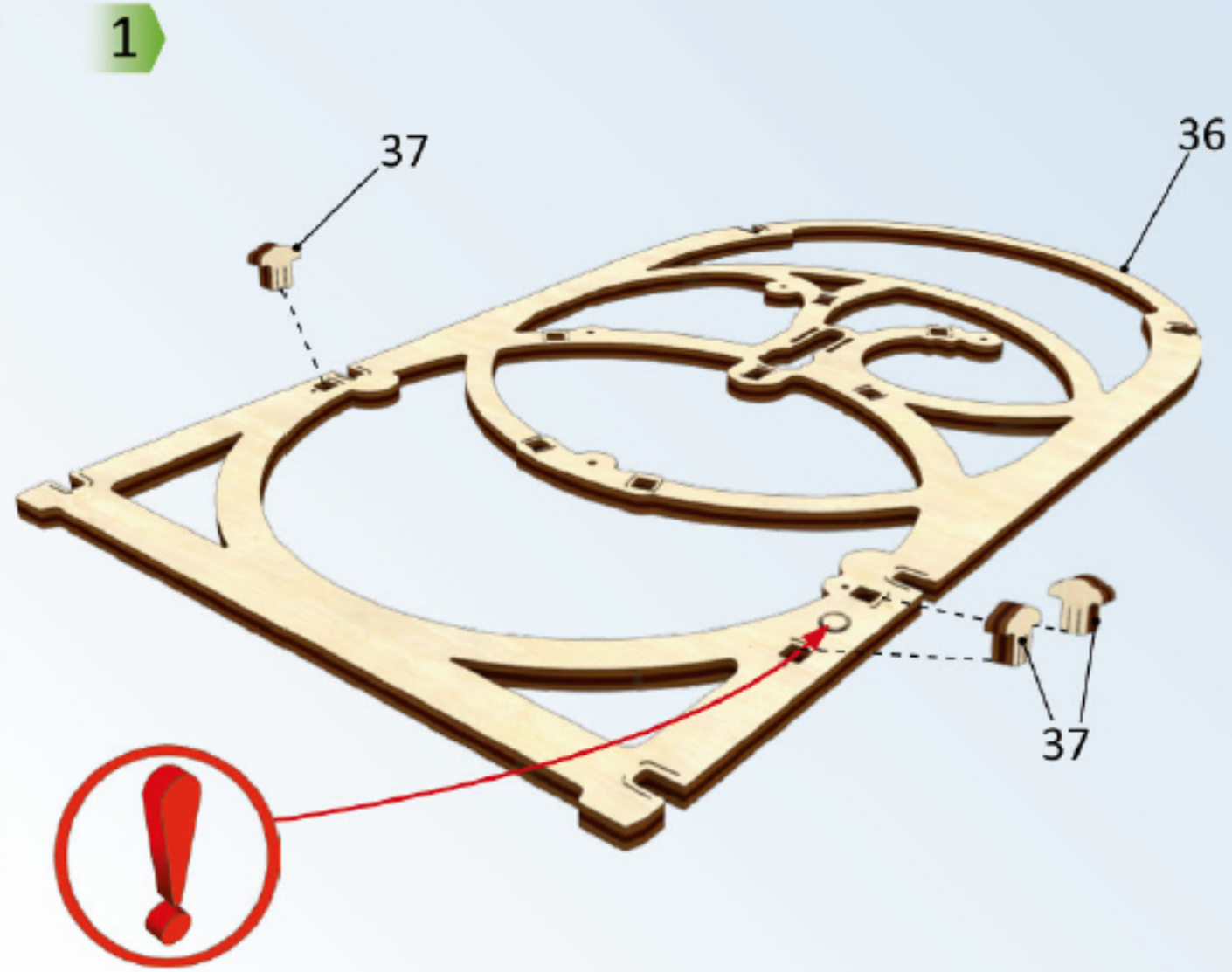
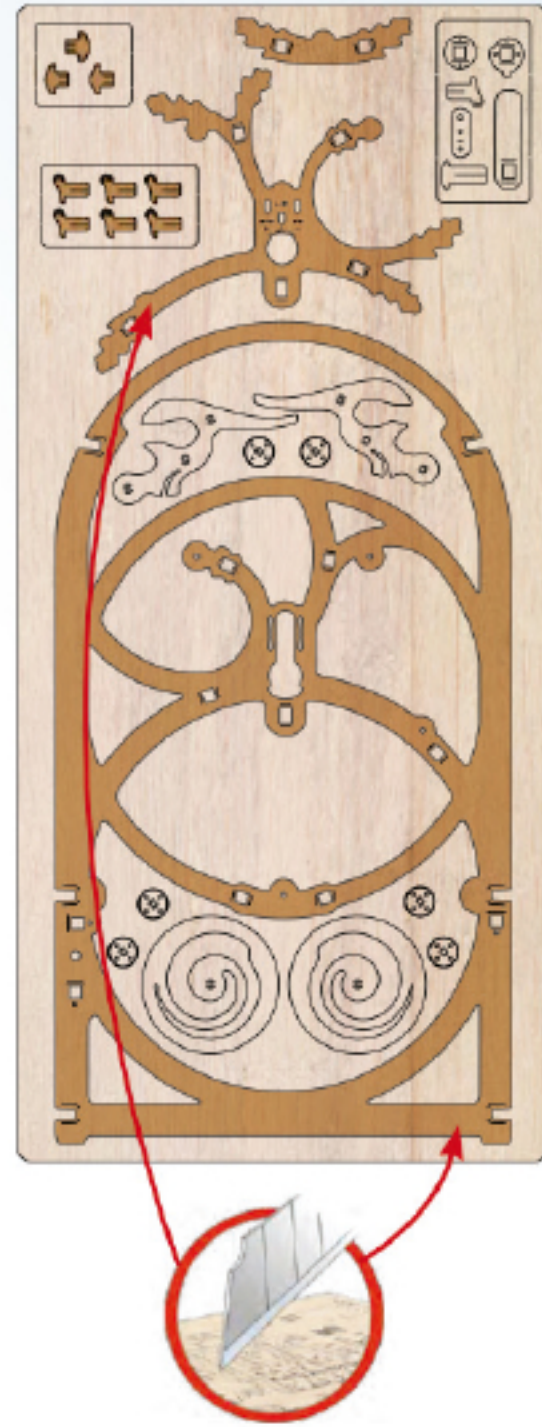
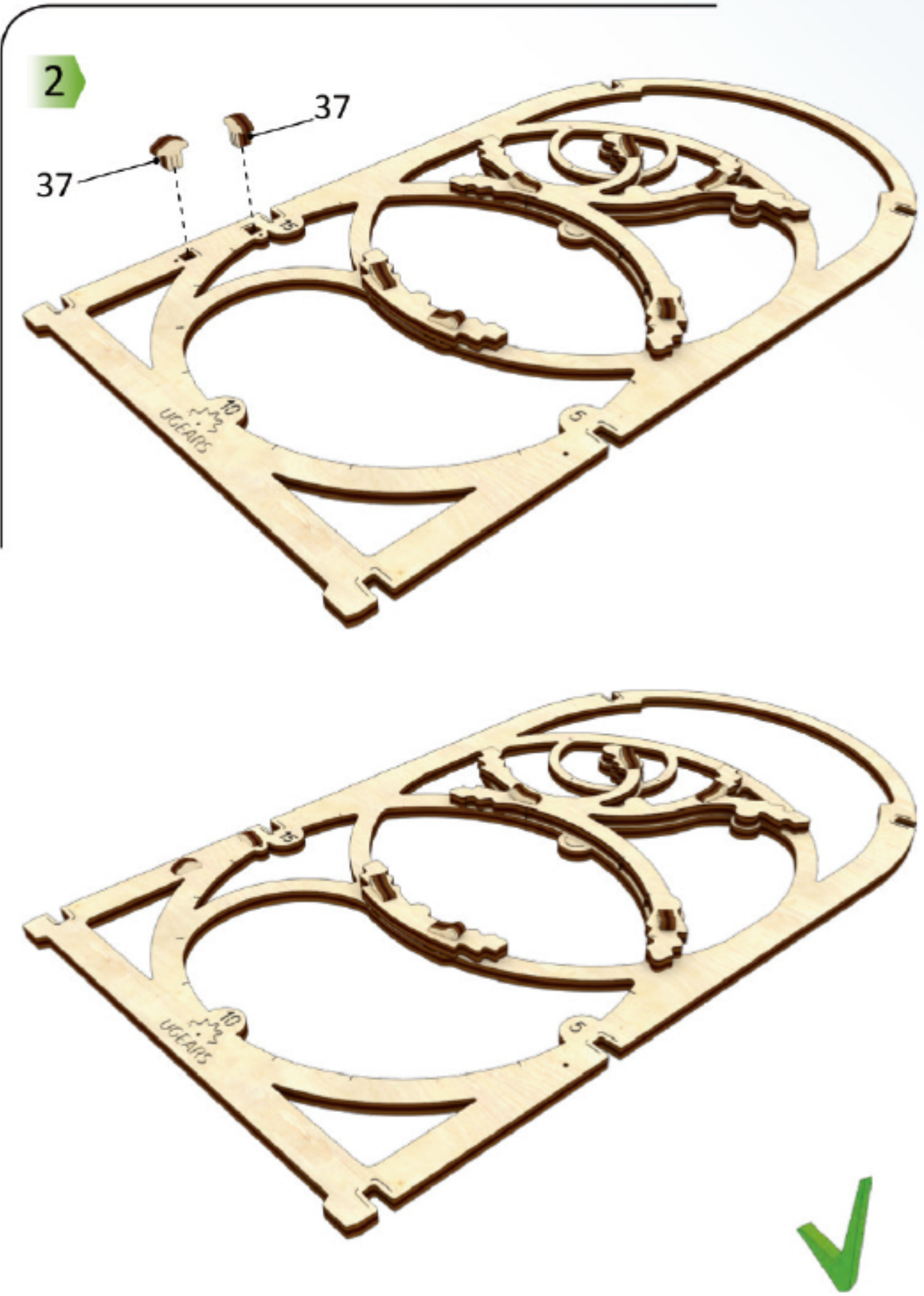

3

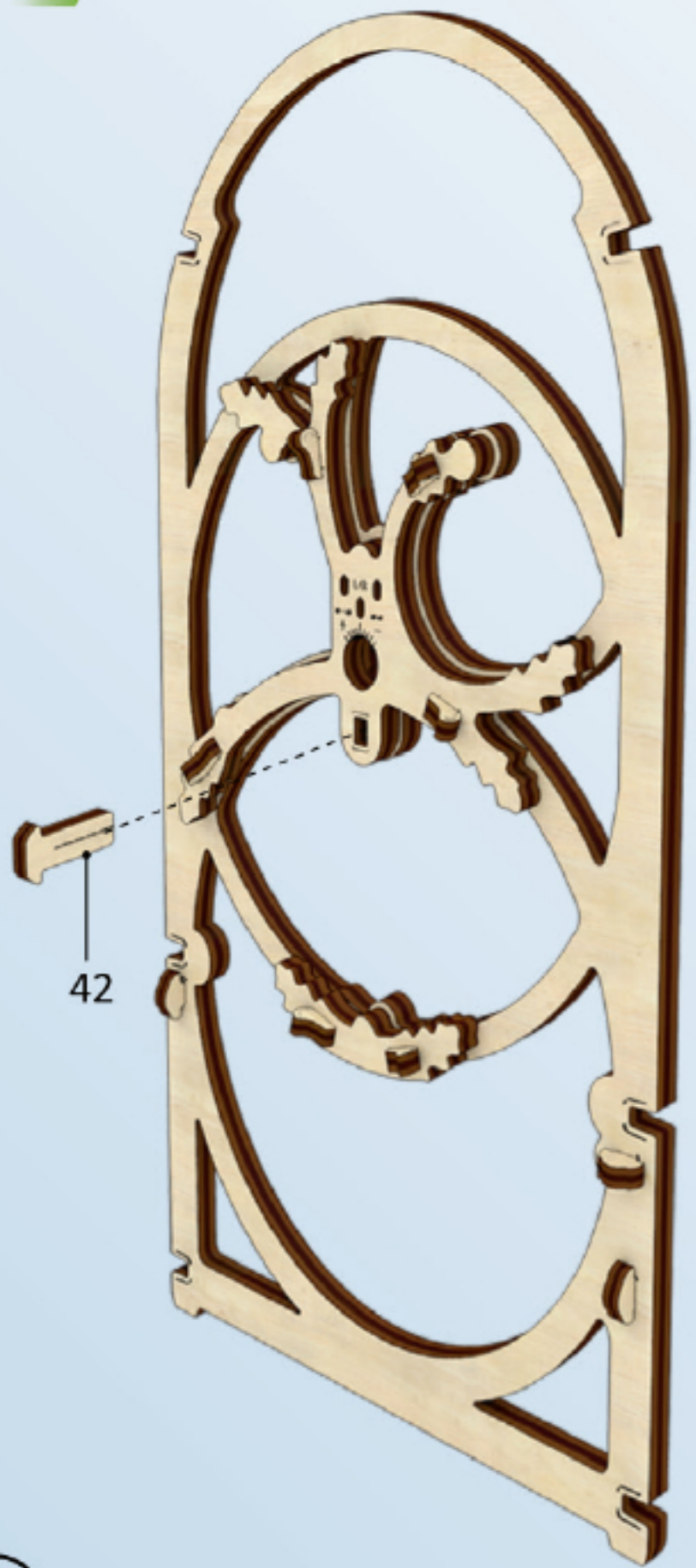

4

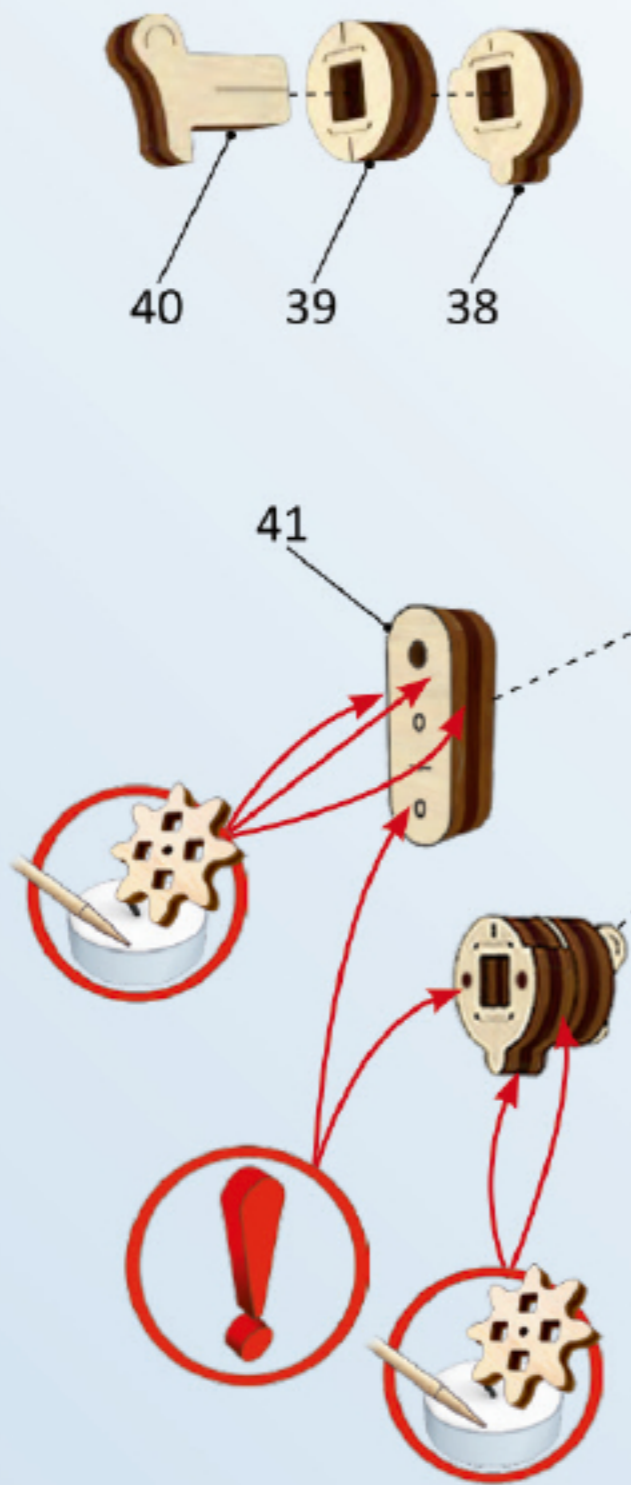

5

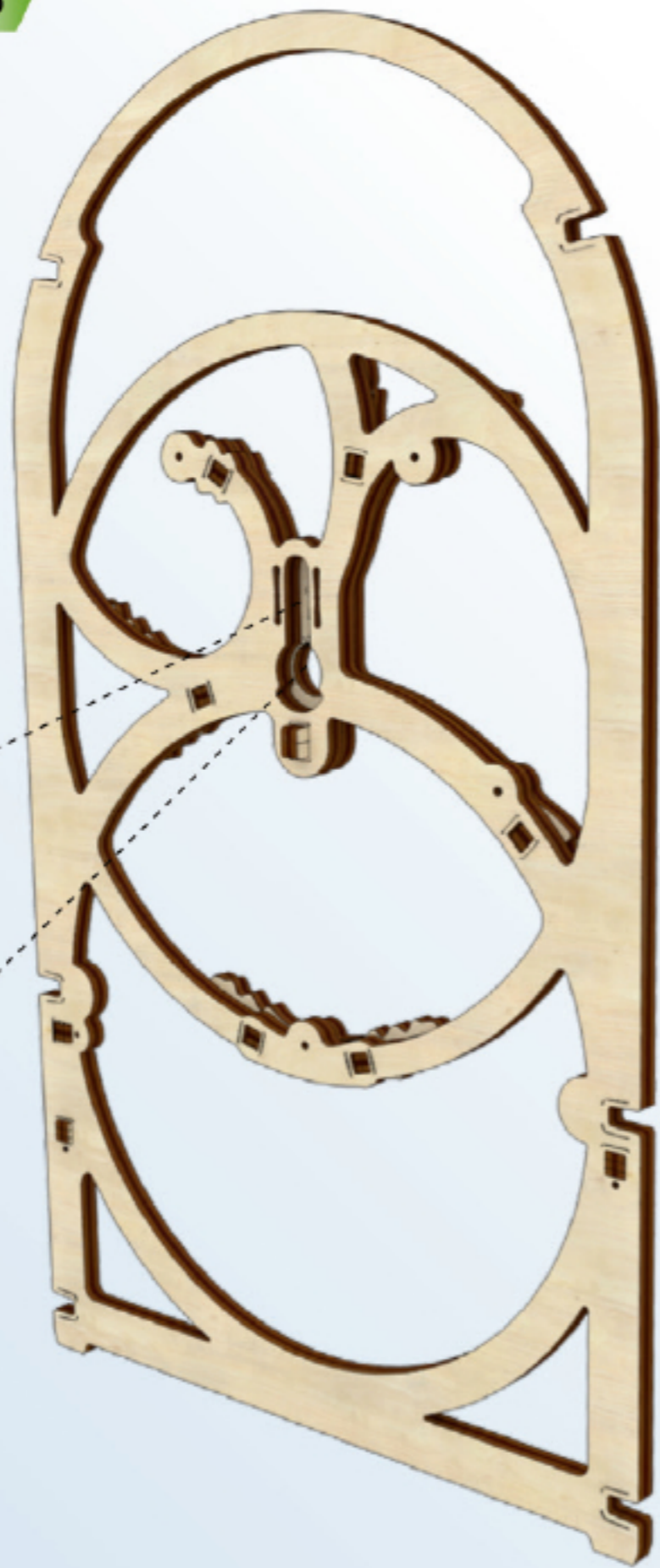

6

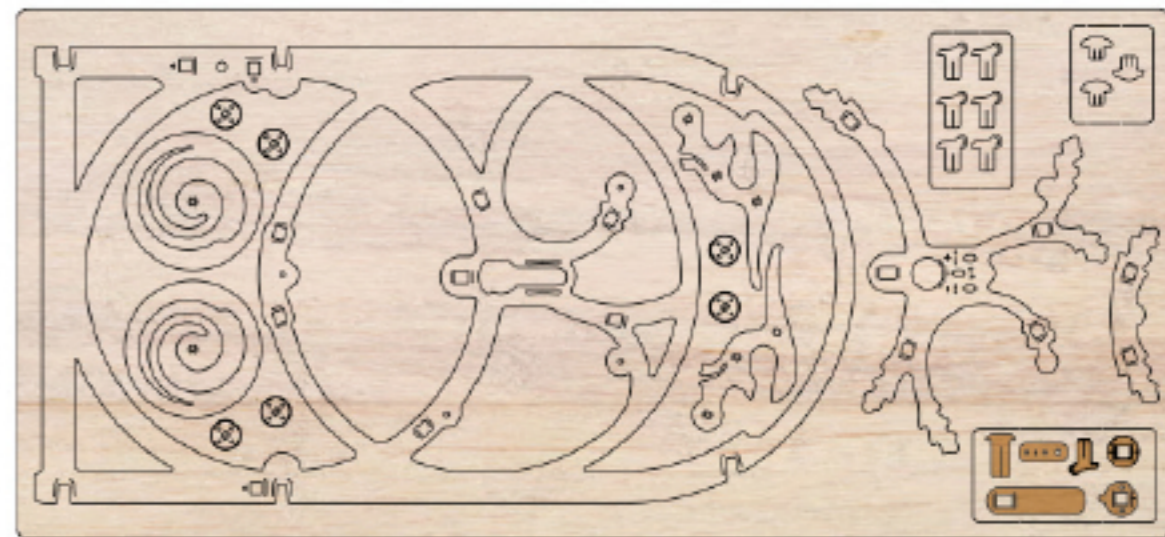
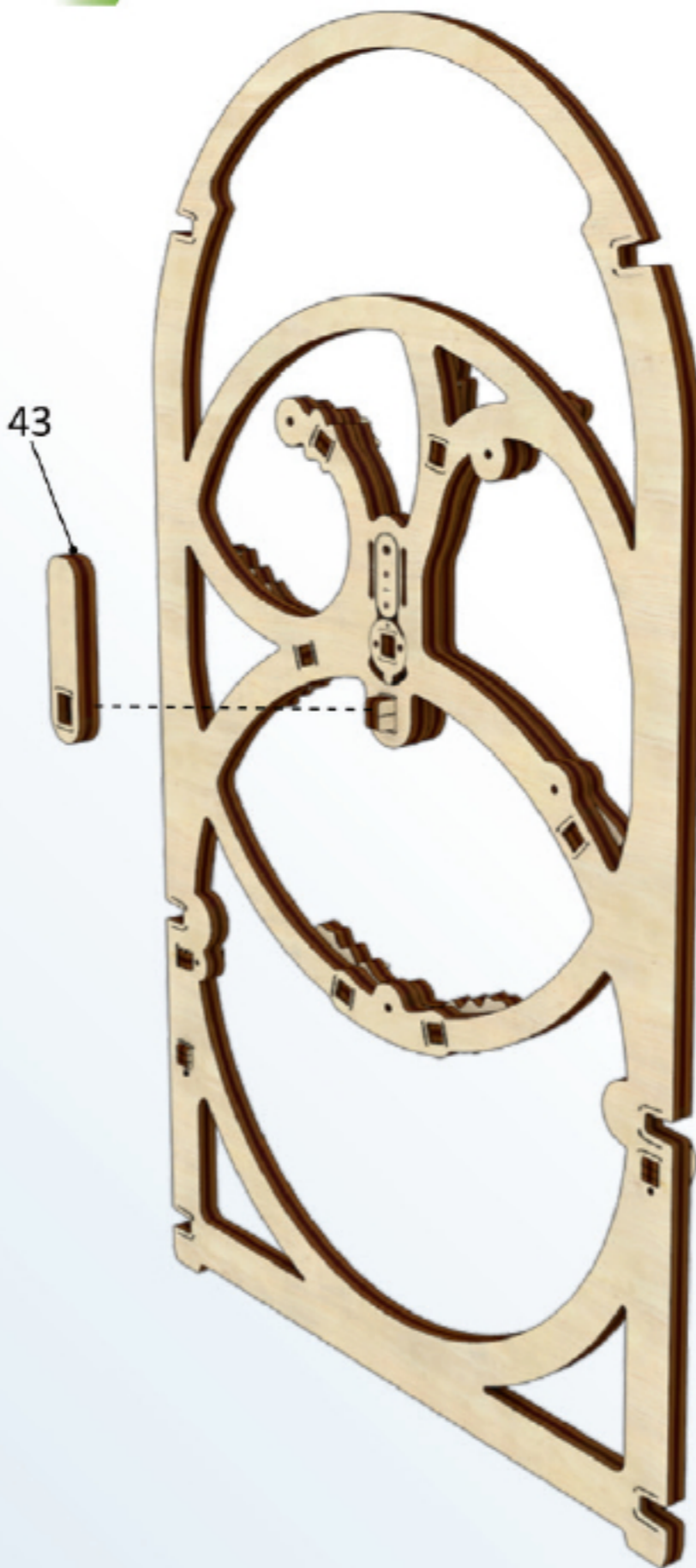

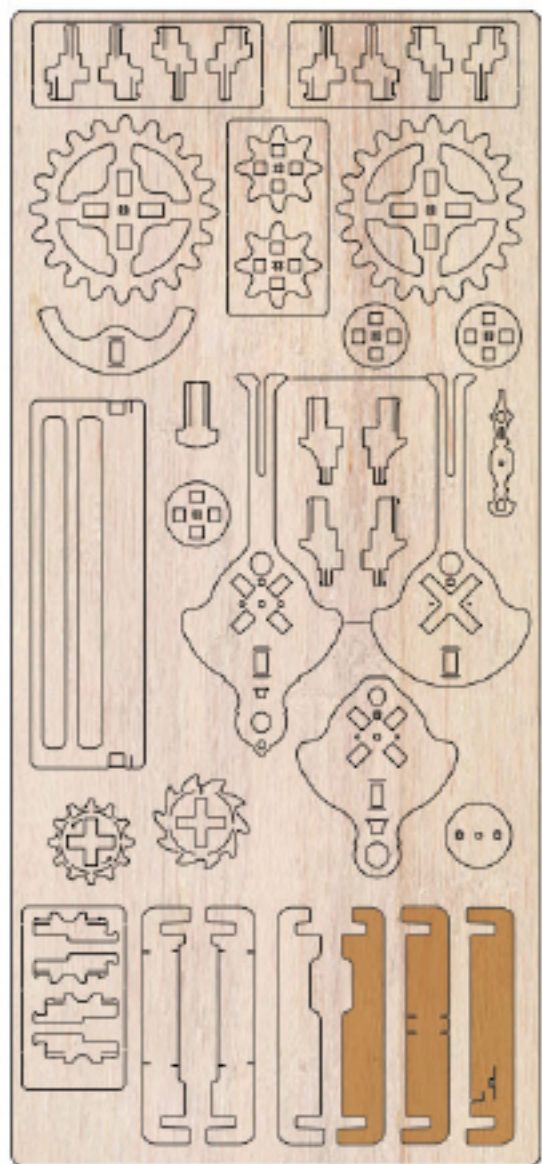

7

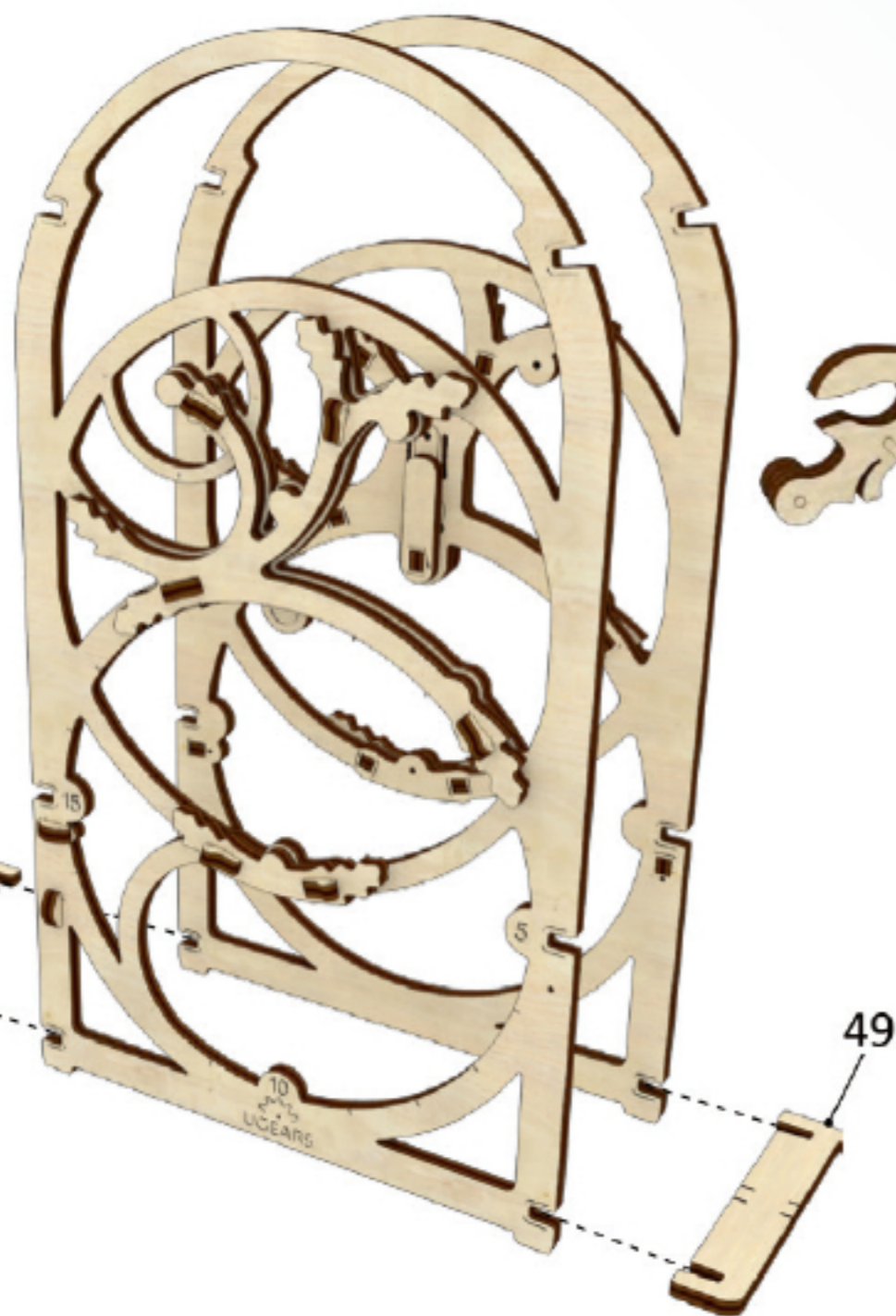

8

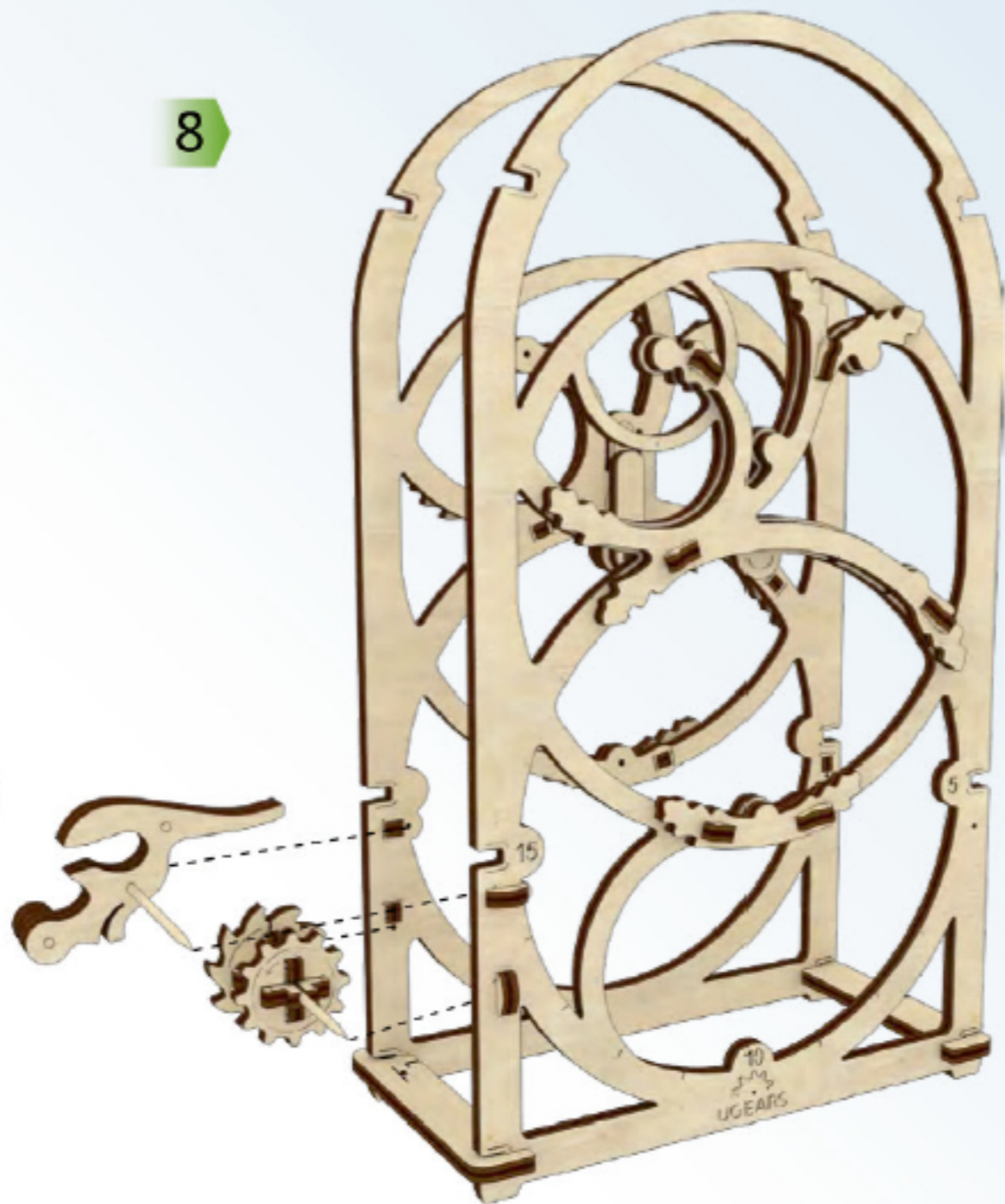

9

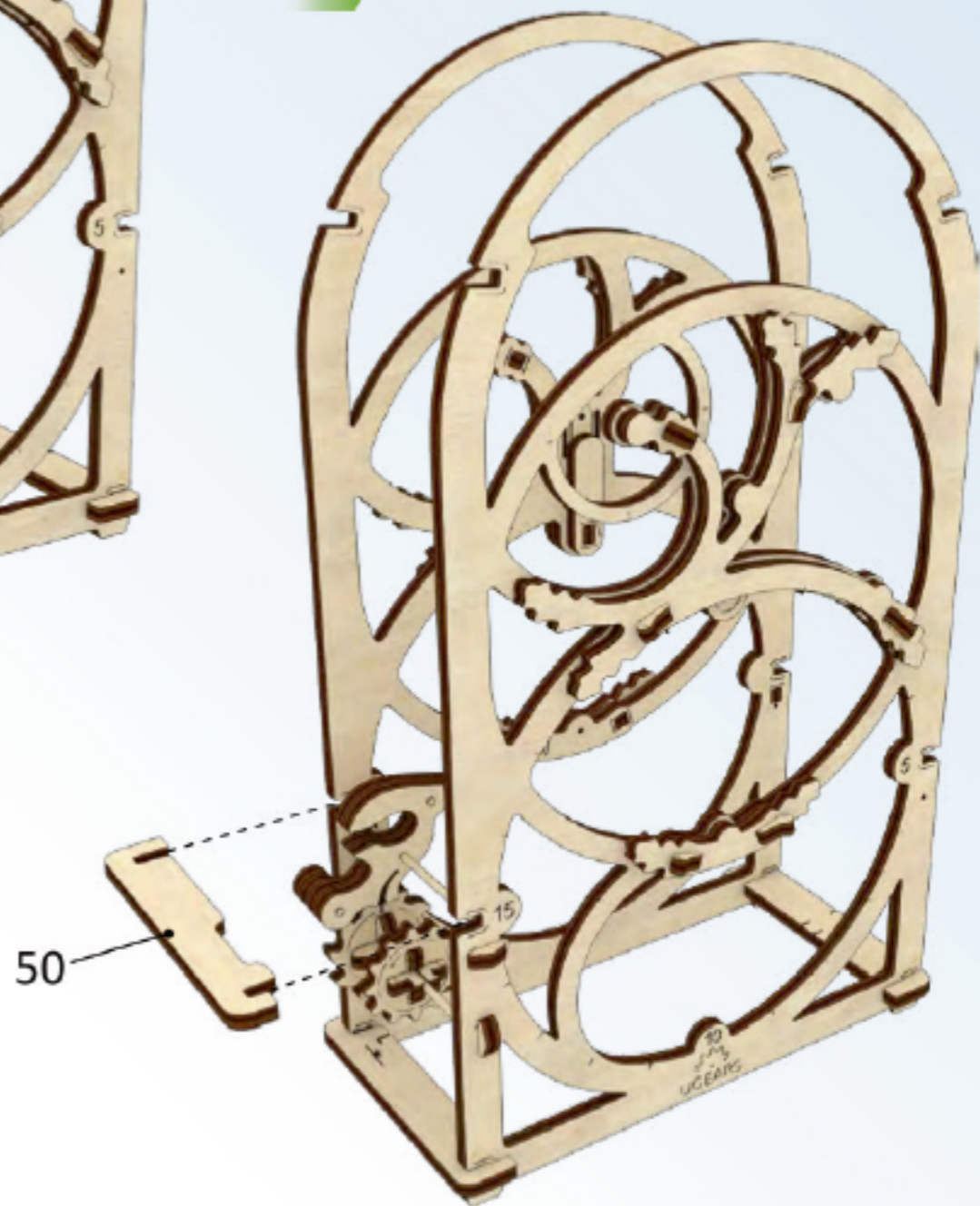

10



11

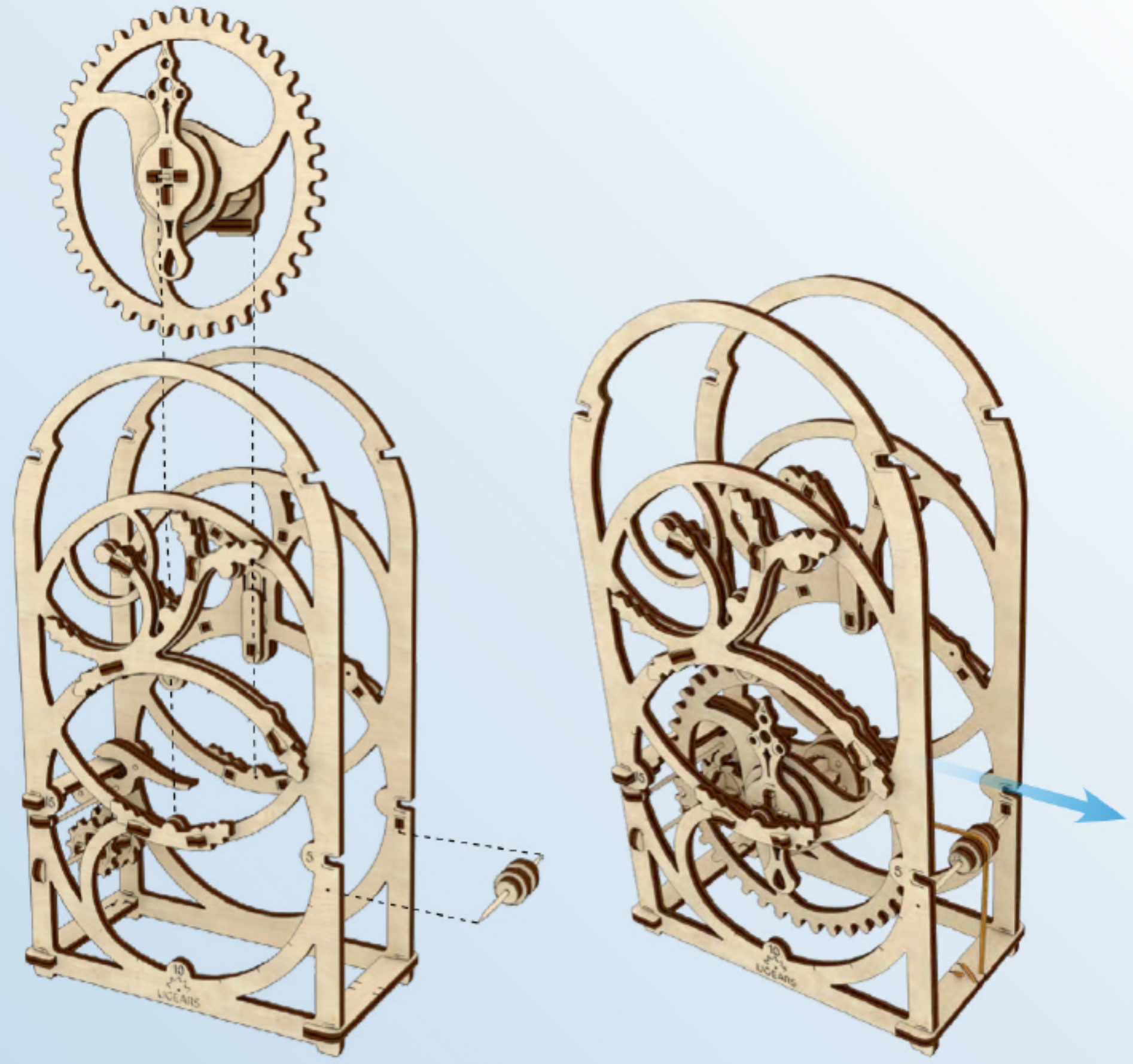

12

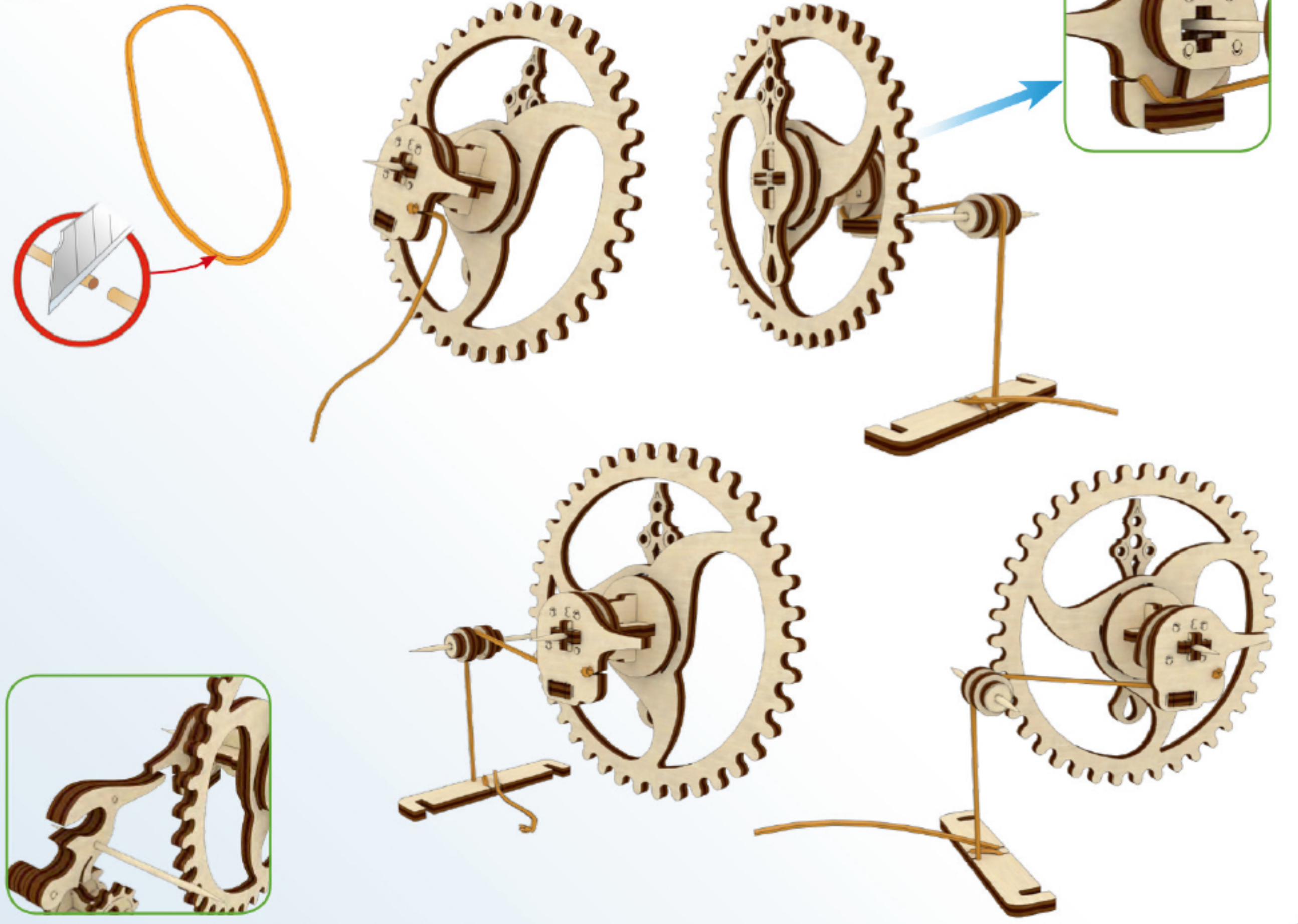



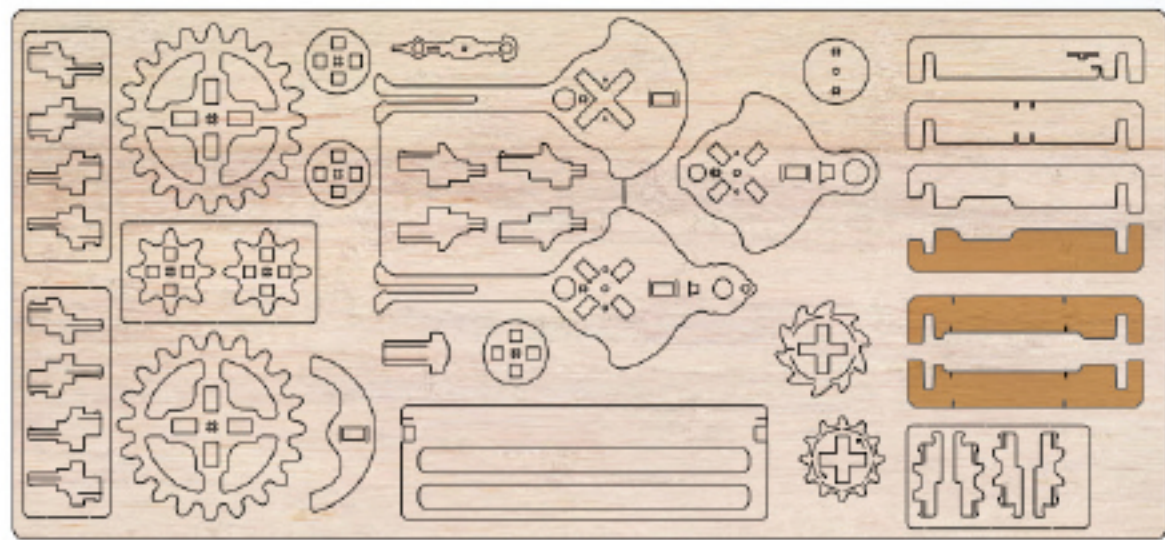

13



50

14



15



16

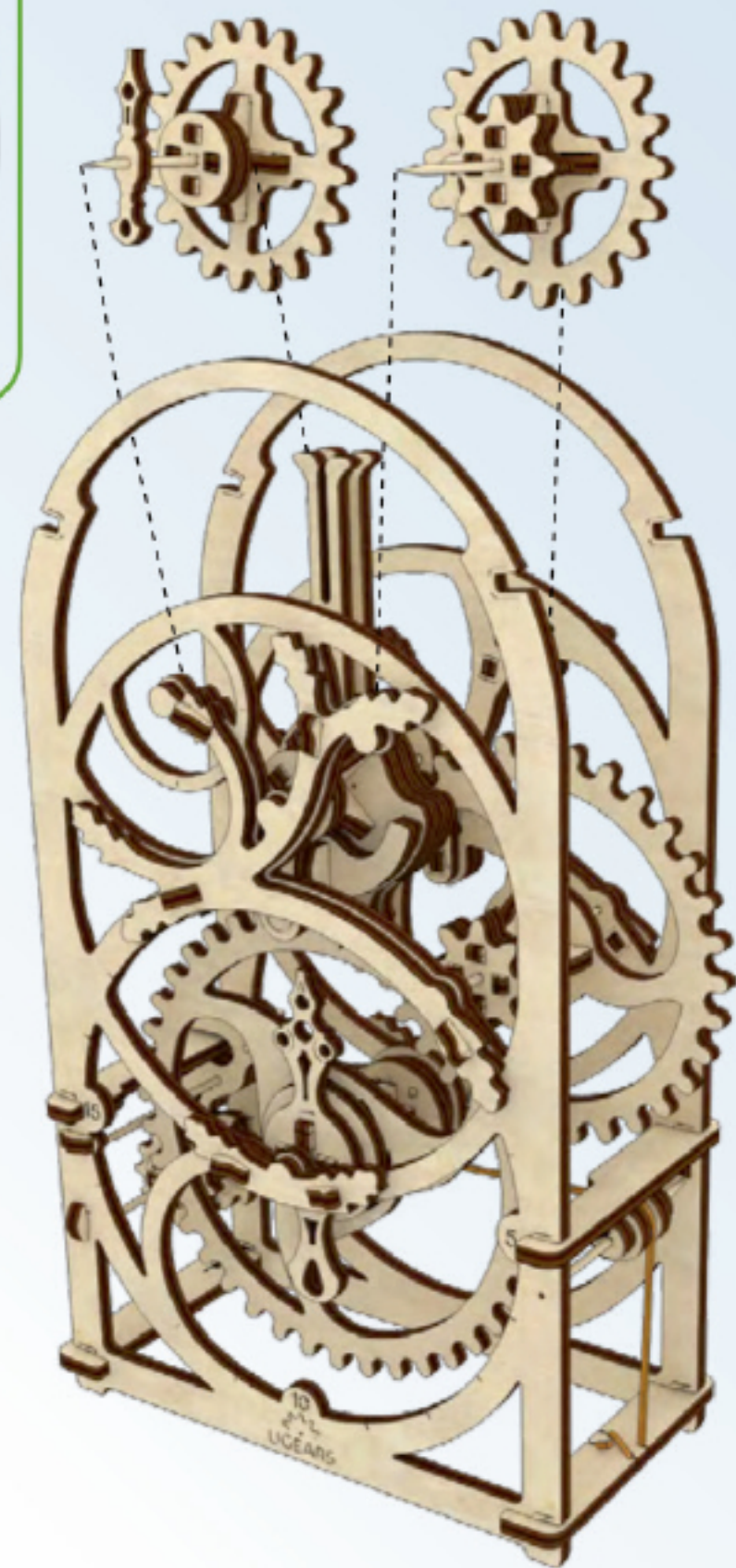

17

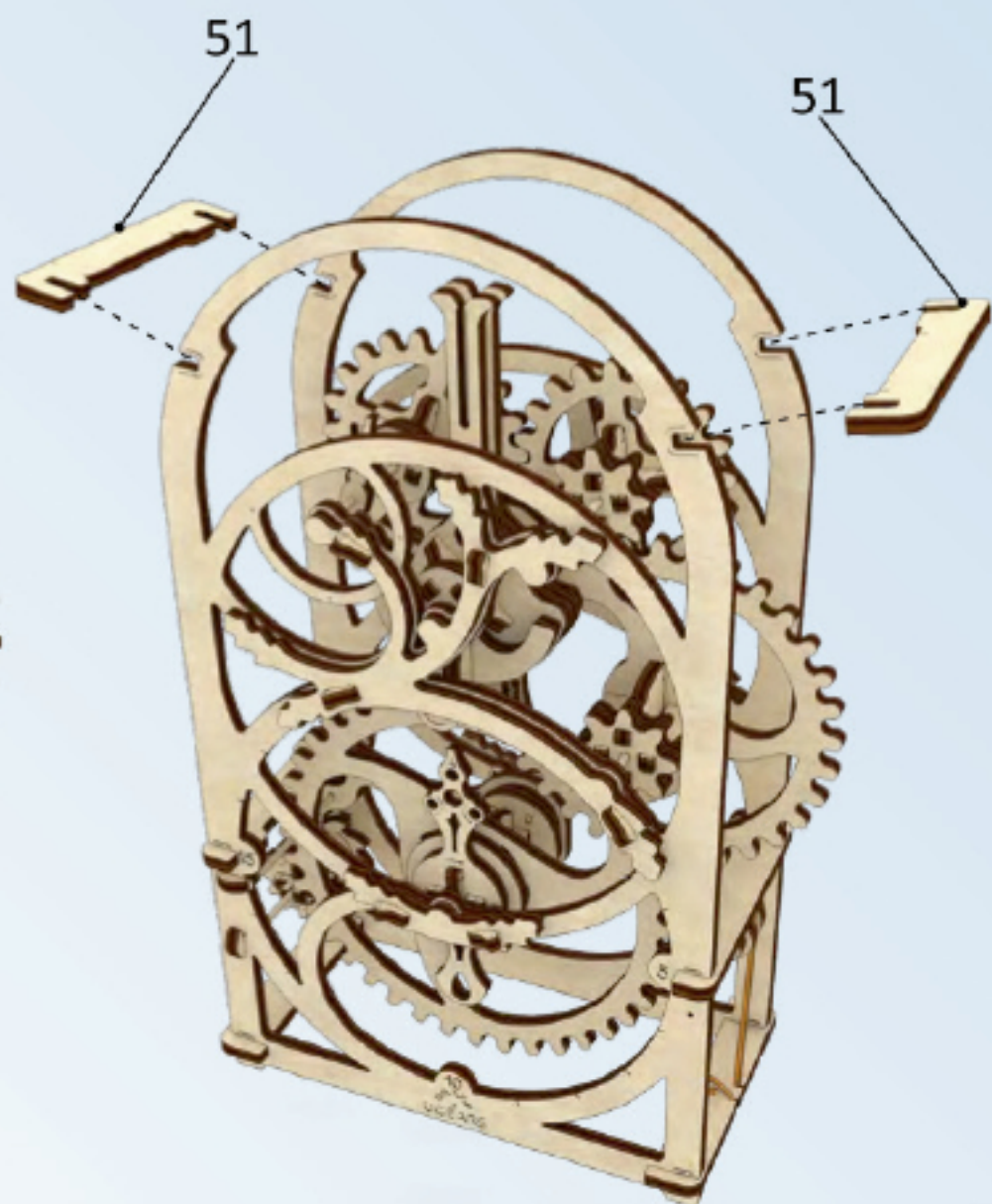

51

51

18

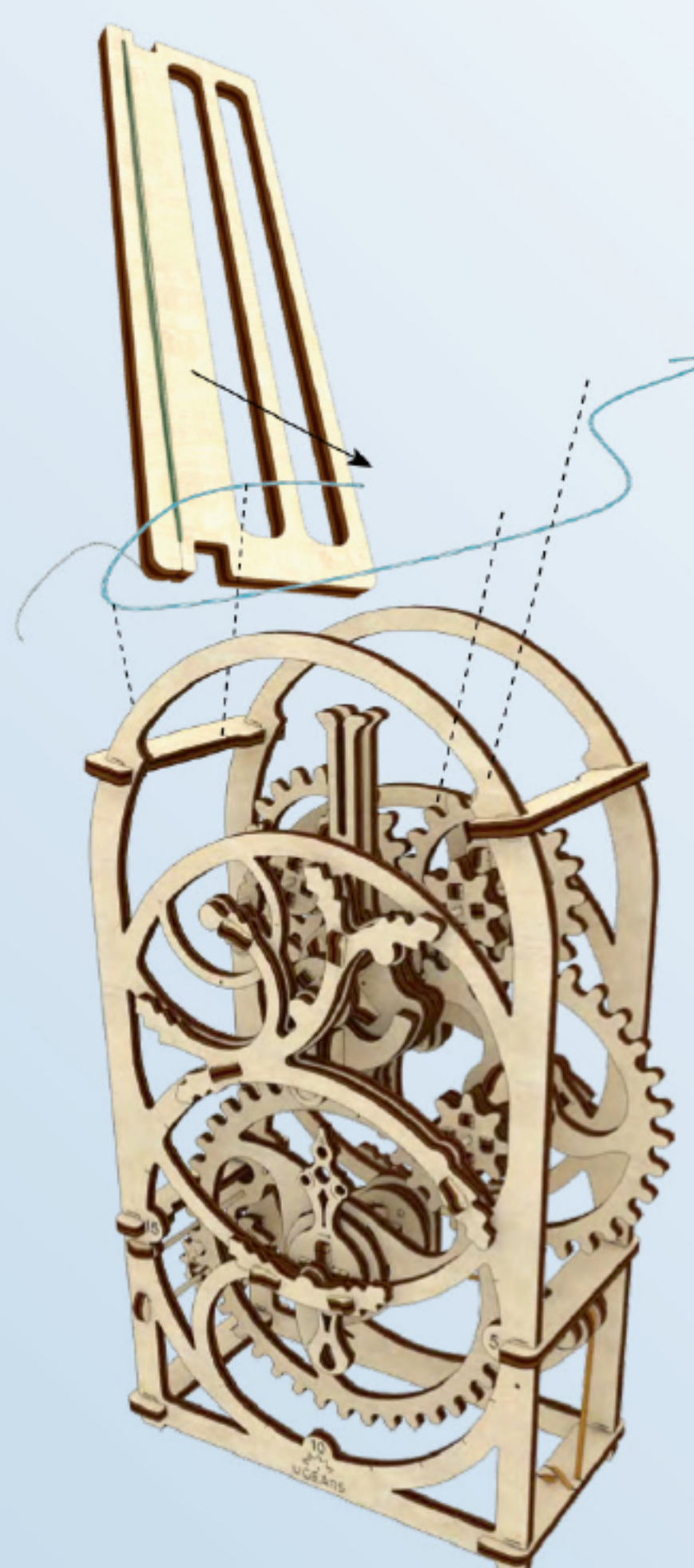

19

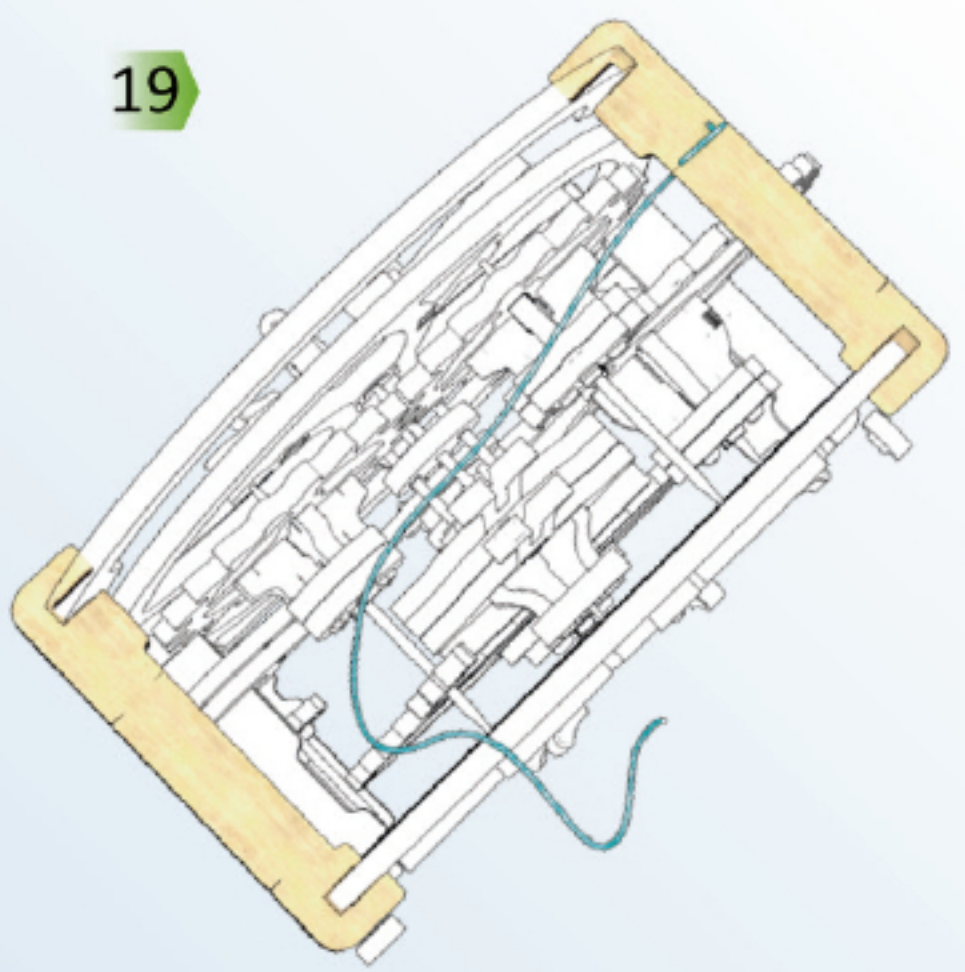

20

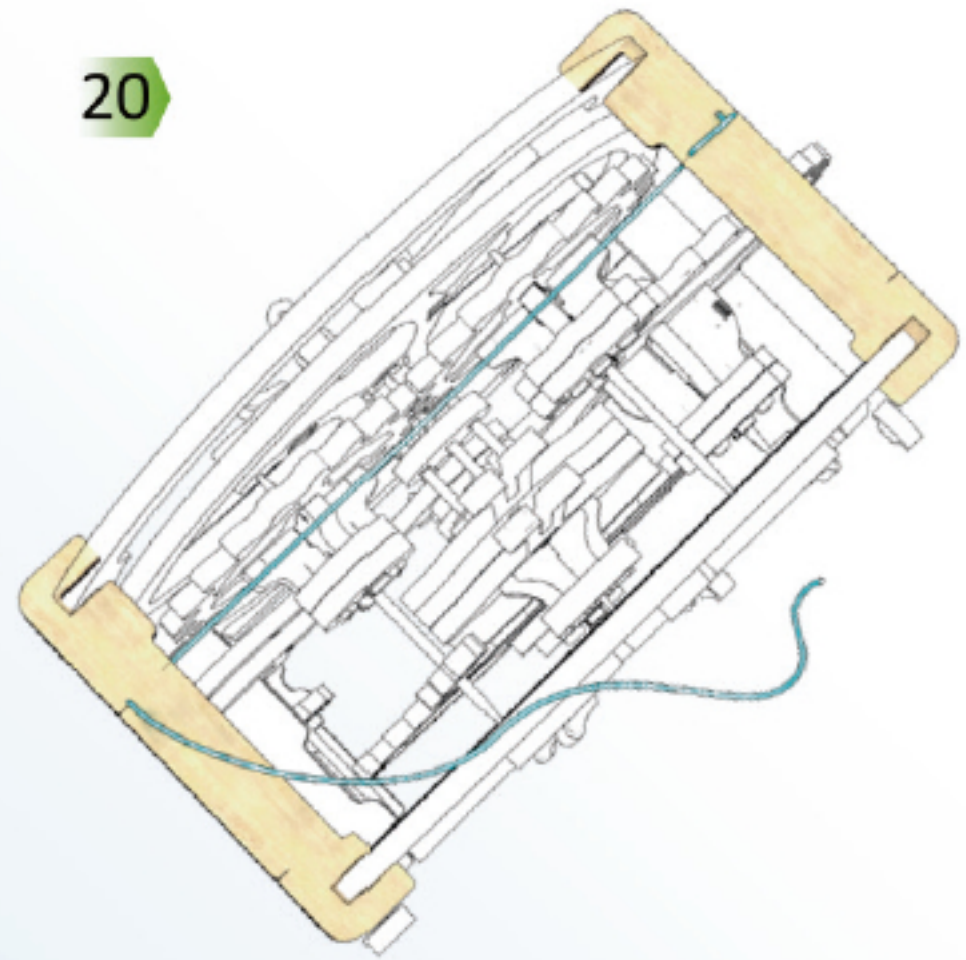

21

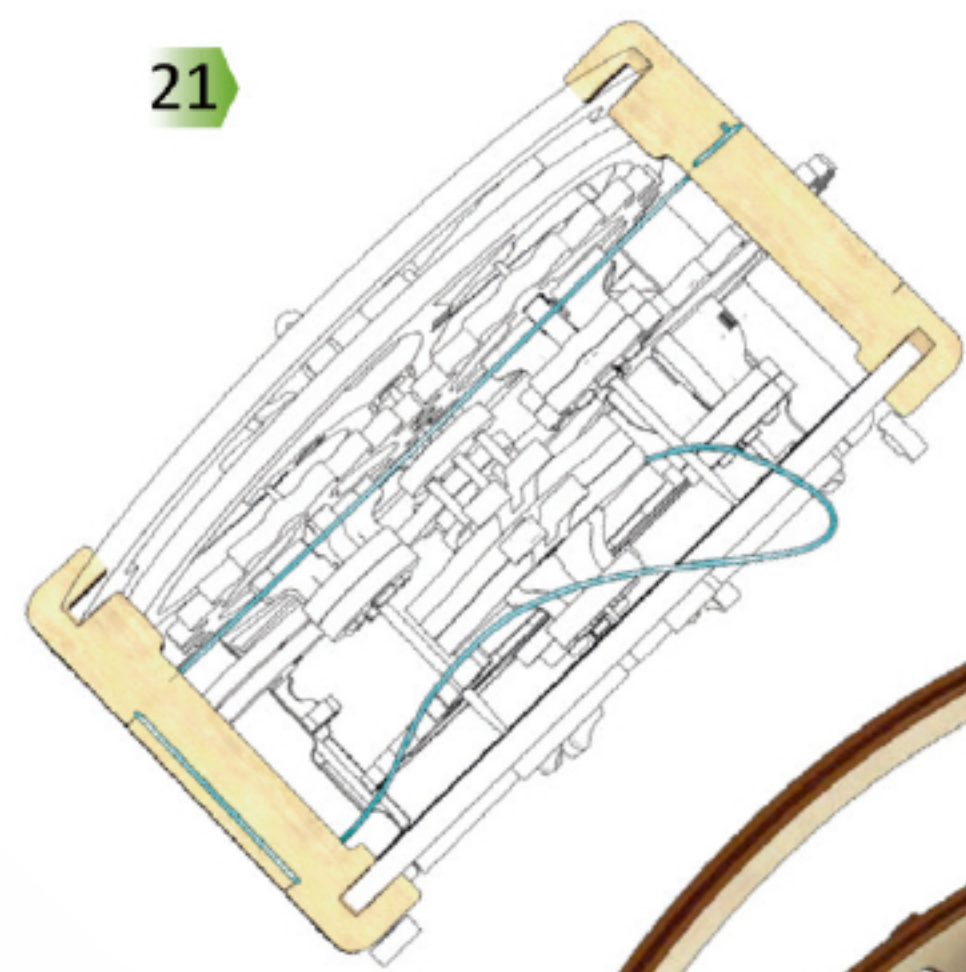

22

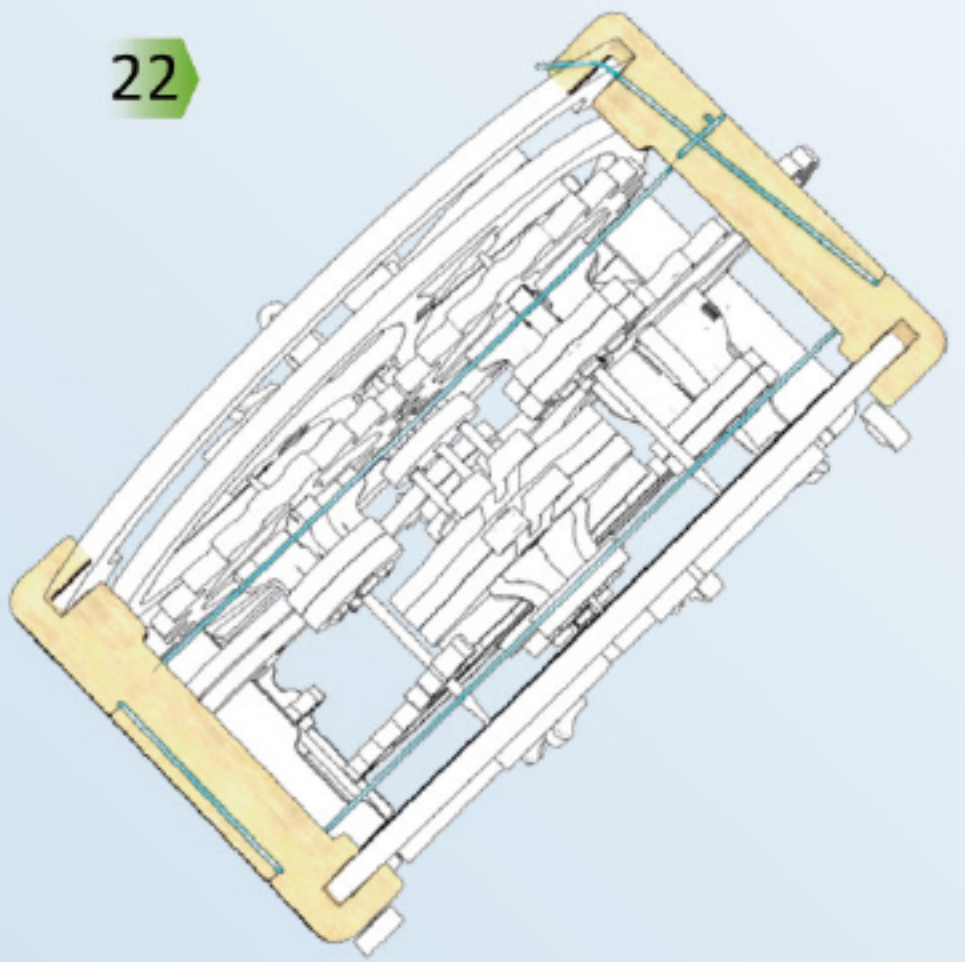

23

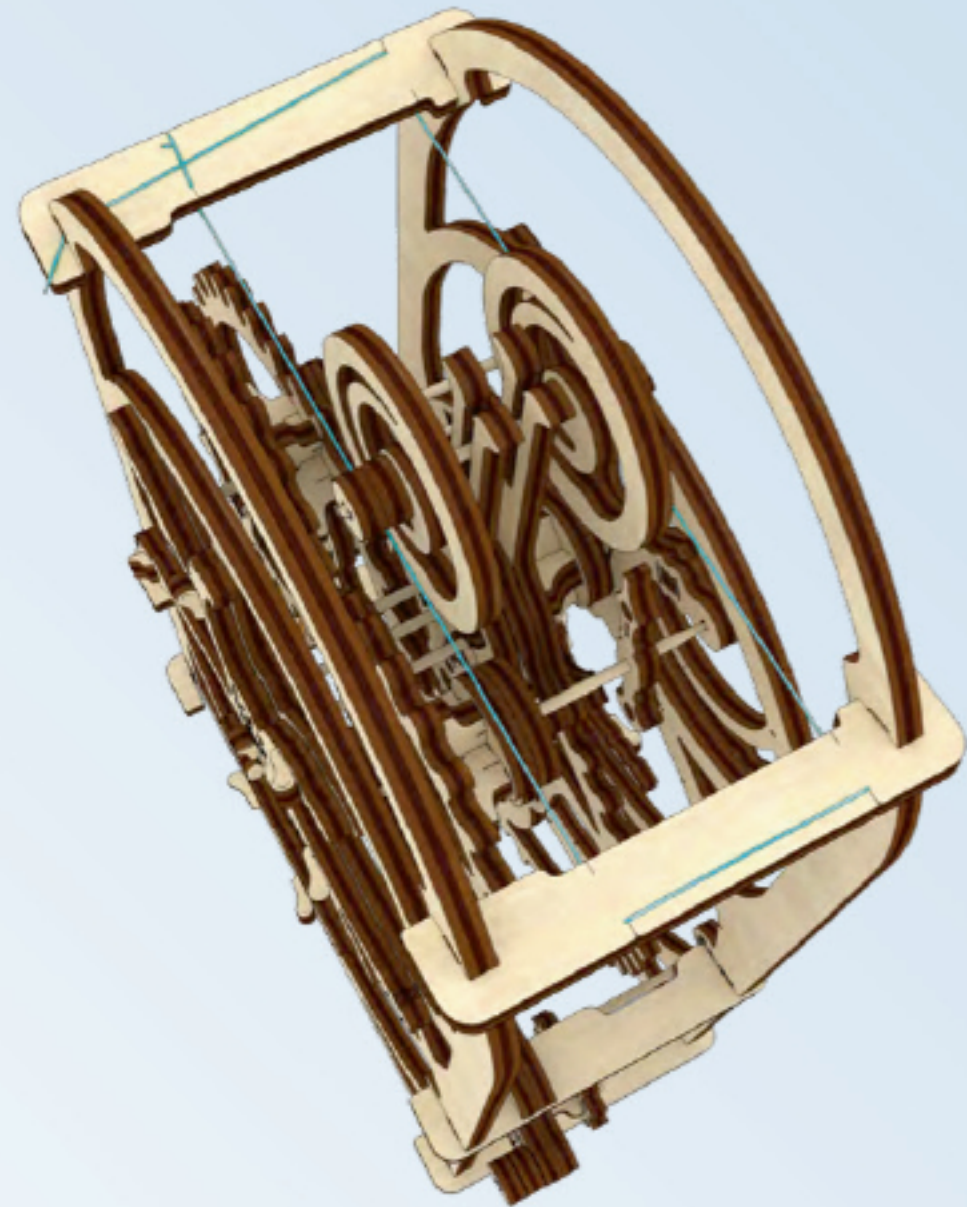
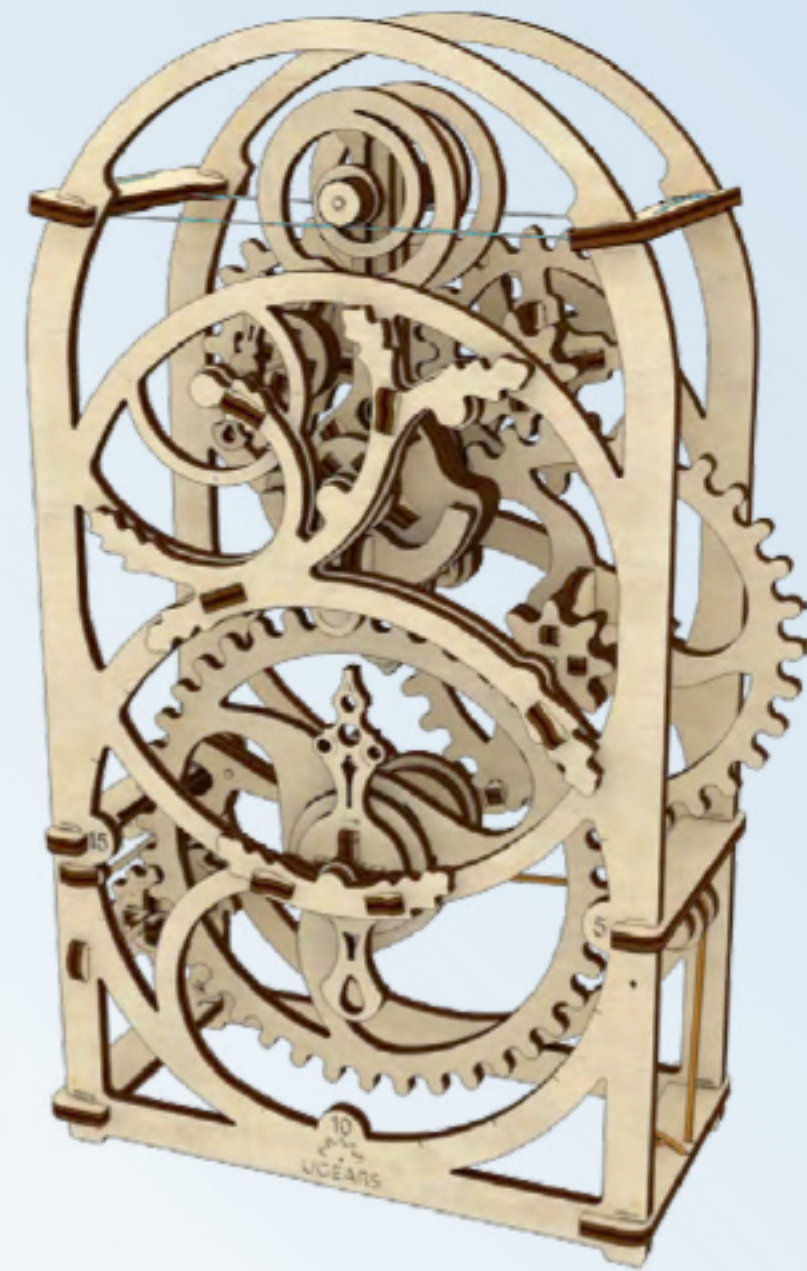
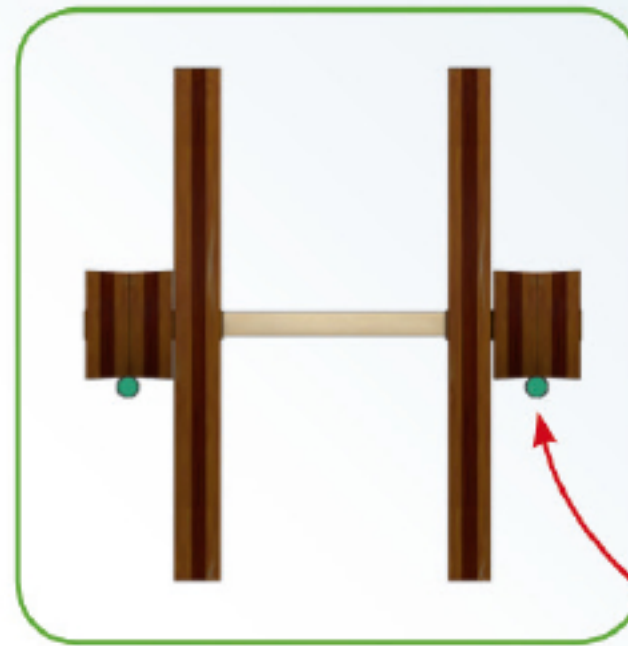
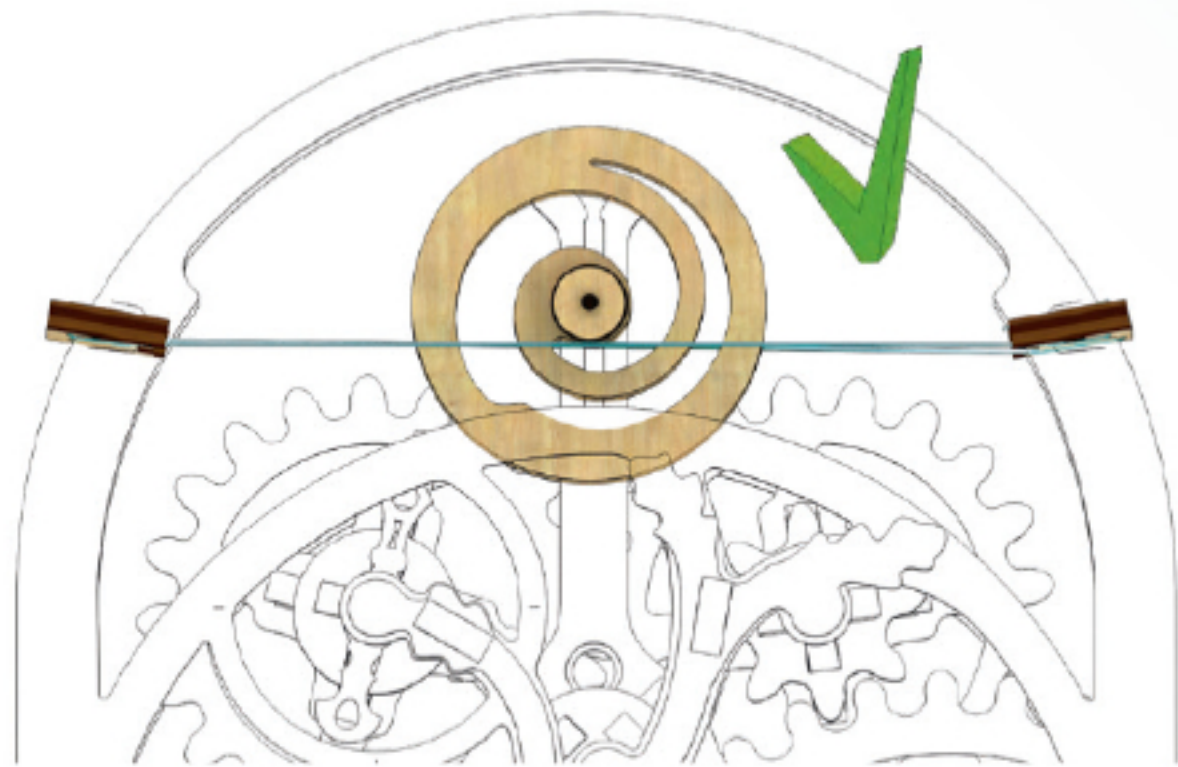
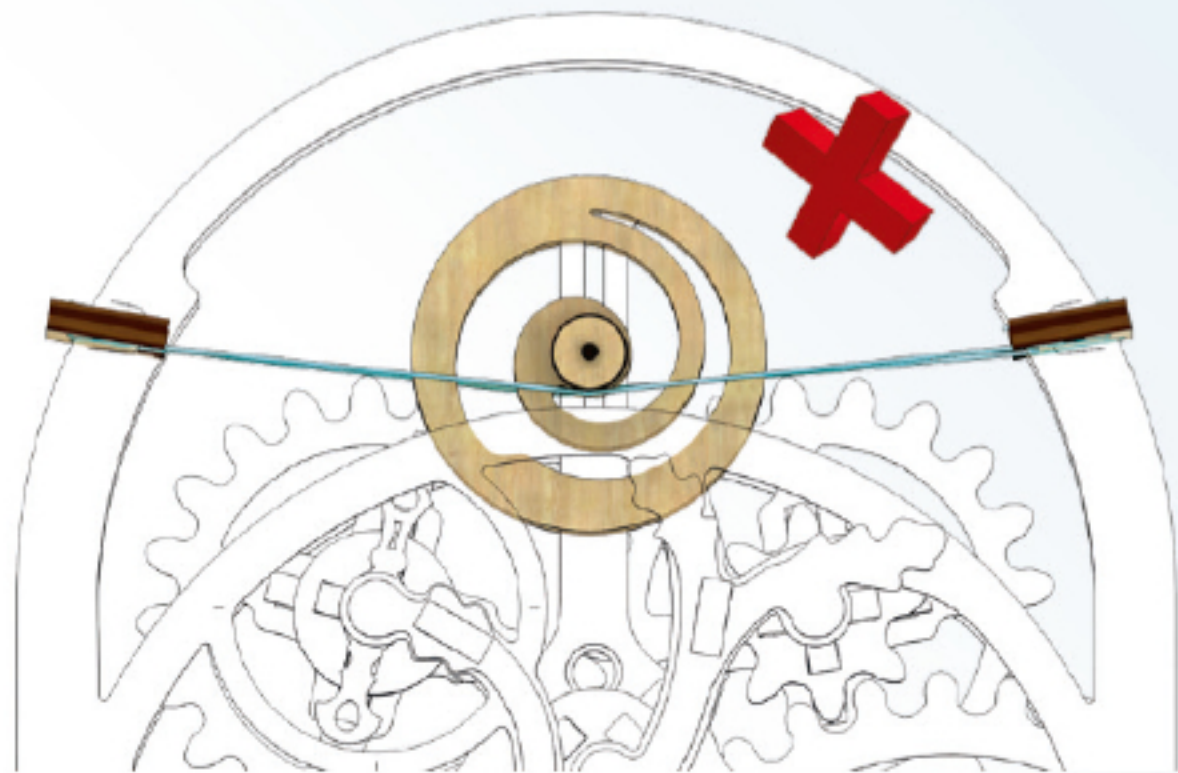
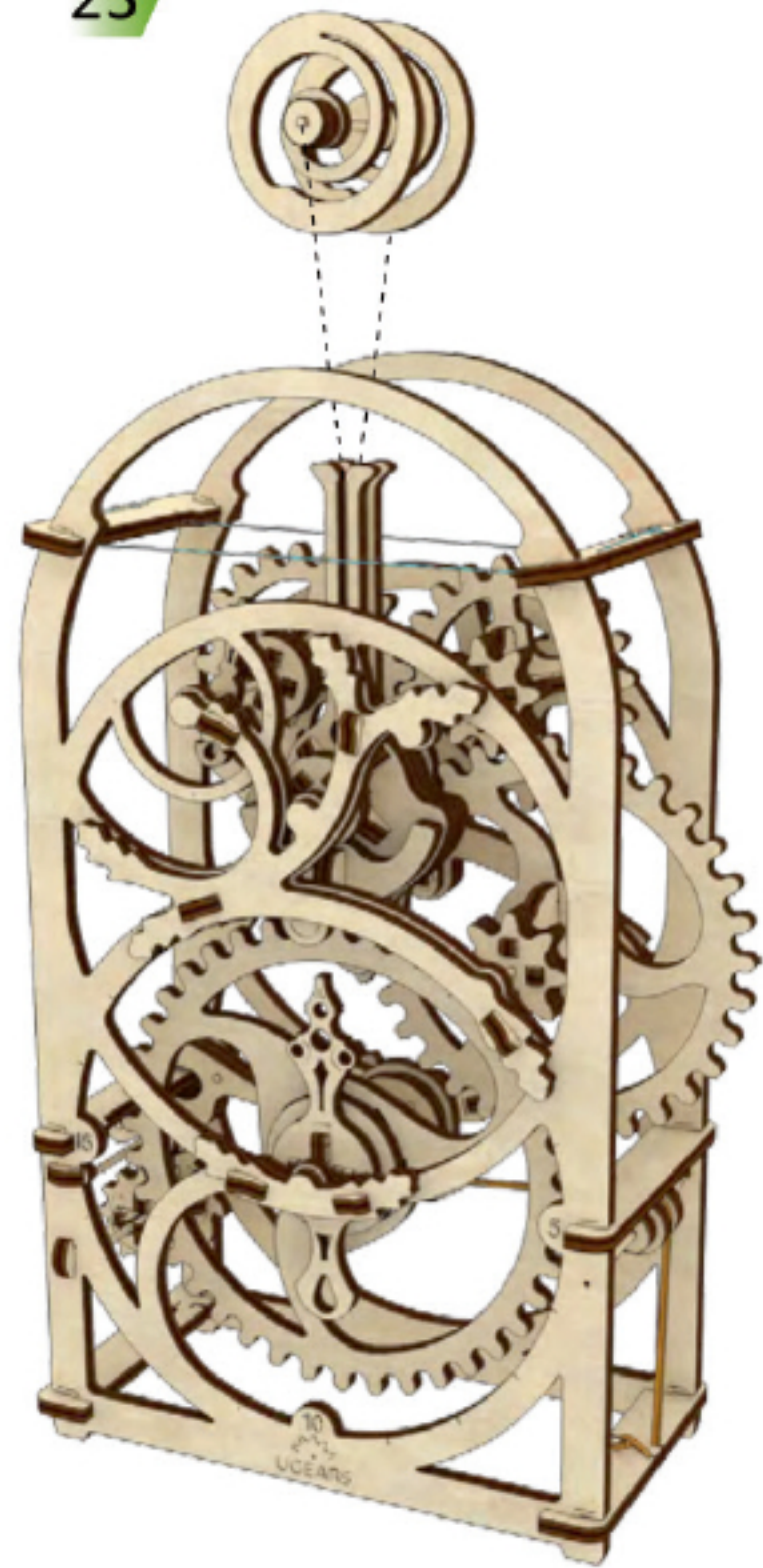

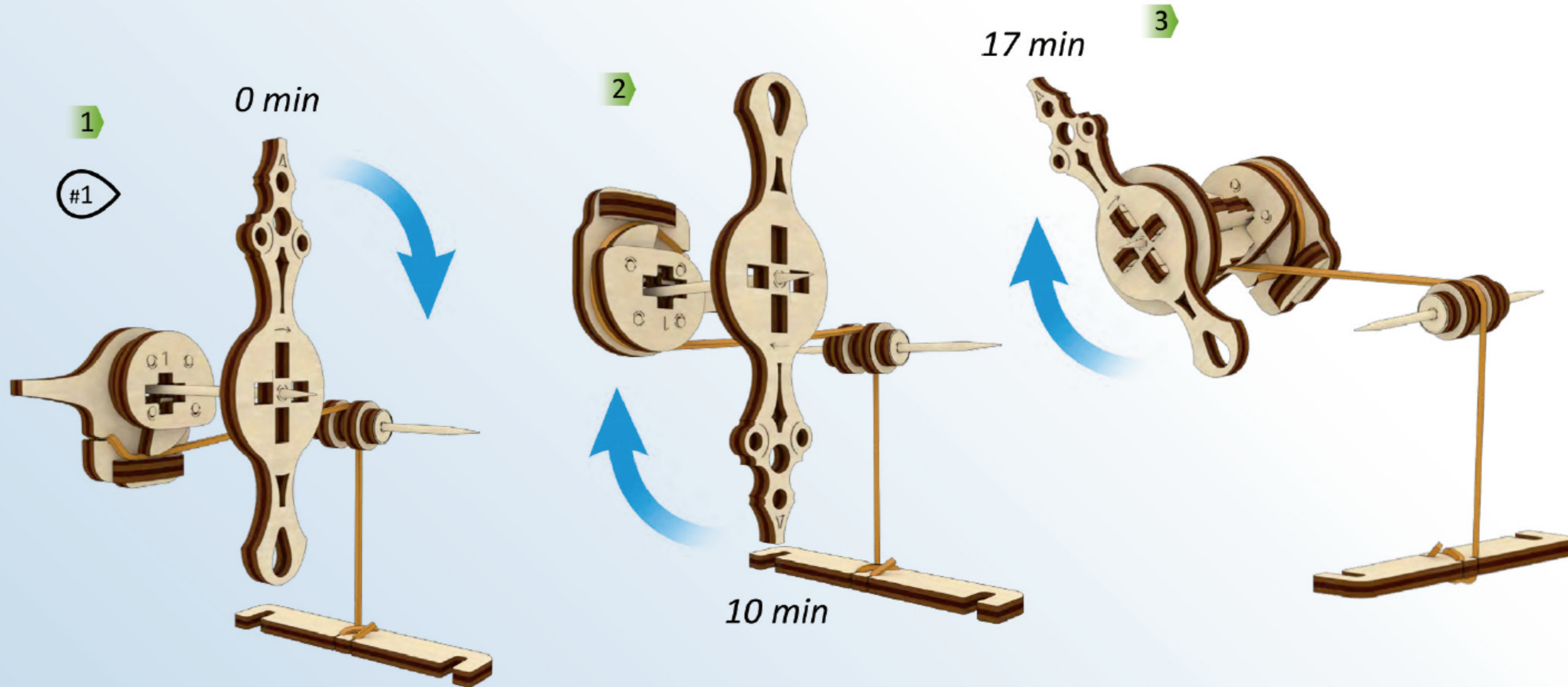

Pas de snelheid van de Timer aan door de spanning in het elastiek aan te spannen of te verminderen. (Figuur 1)



Stel de slingeramplitude in met behulp van de regulatorsleuf aan de achterkant van de timer. (L / R) (figuur 2)

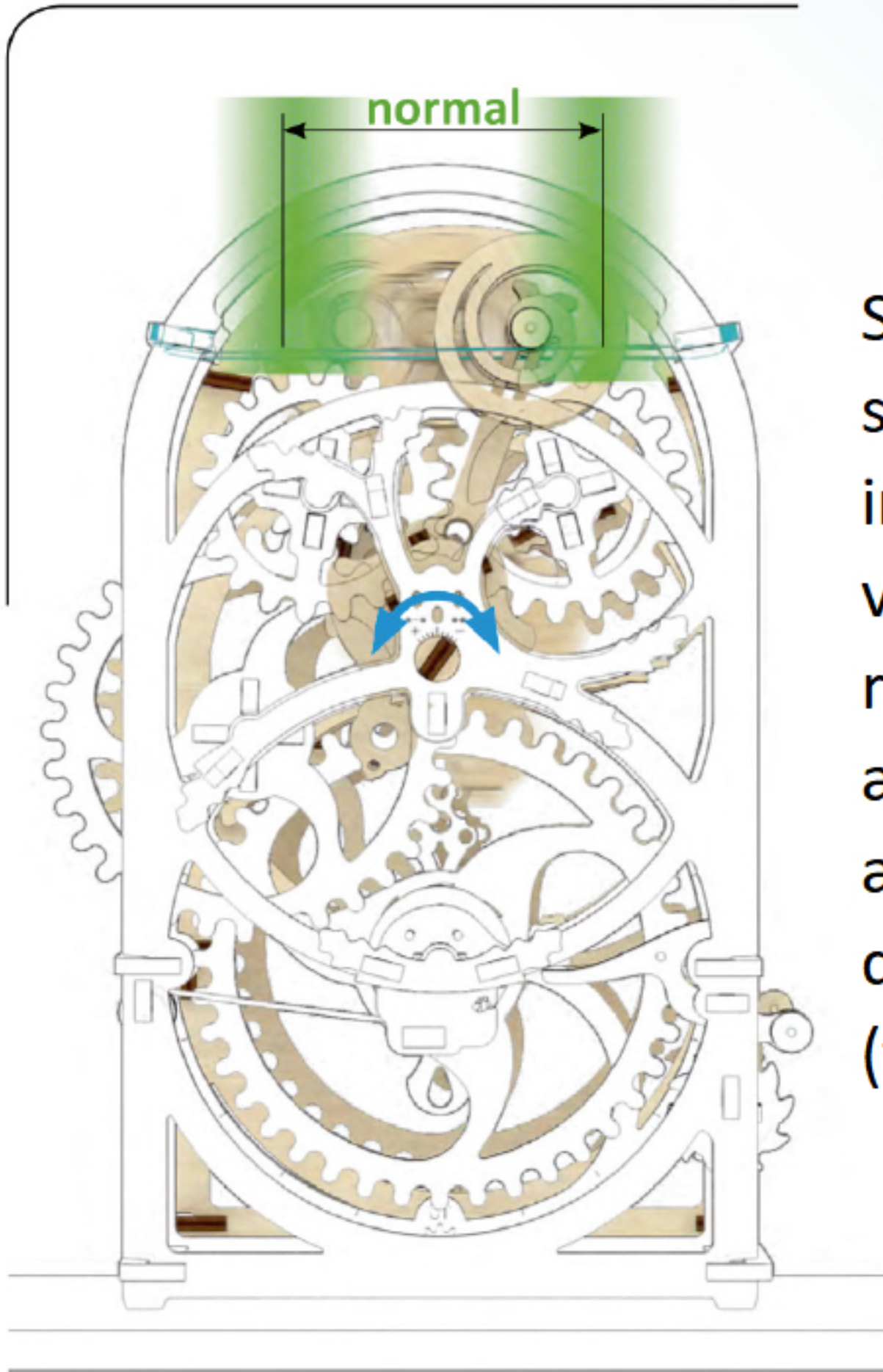

#2

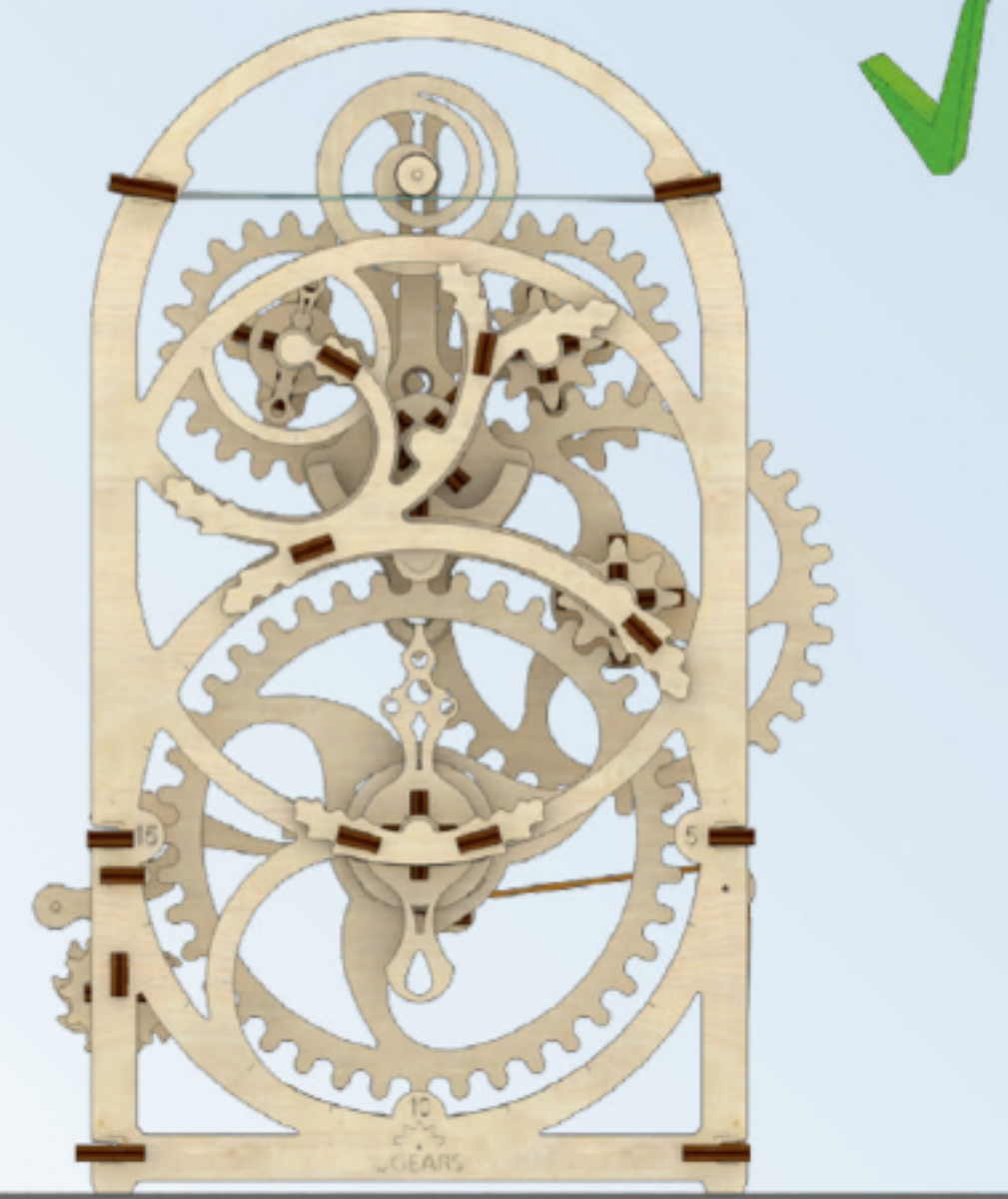
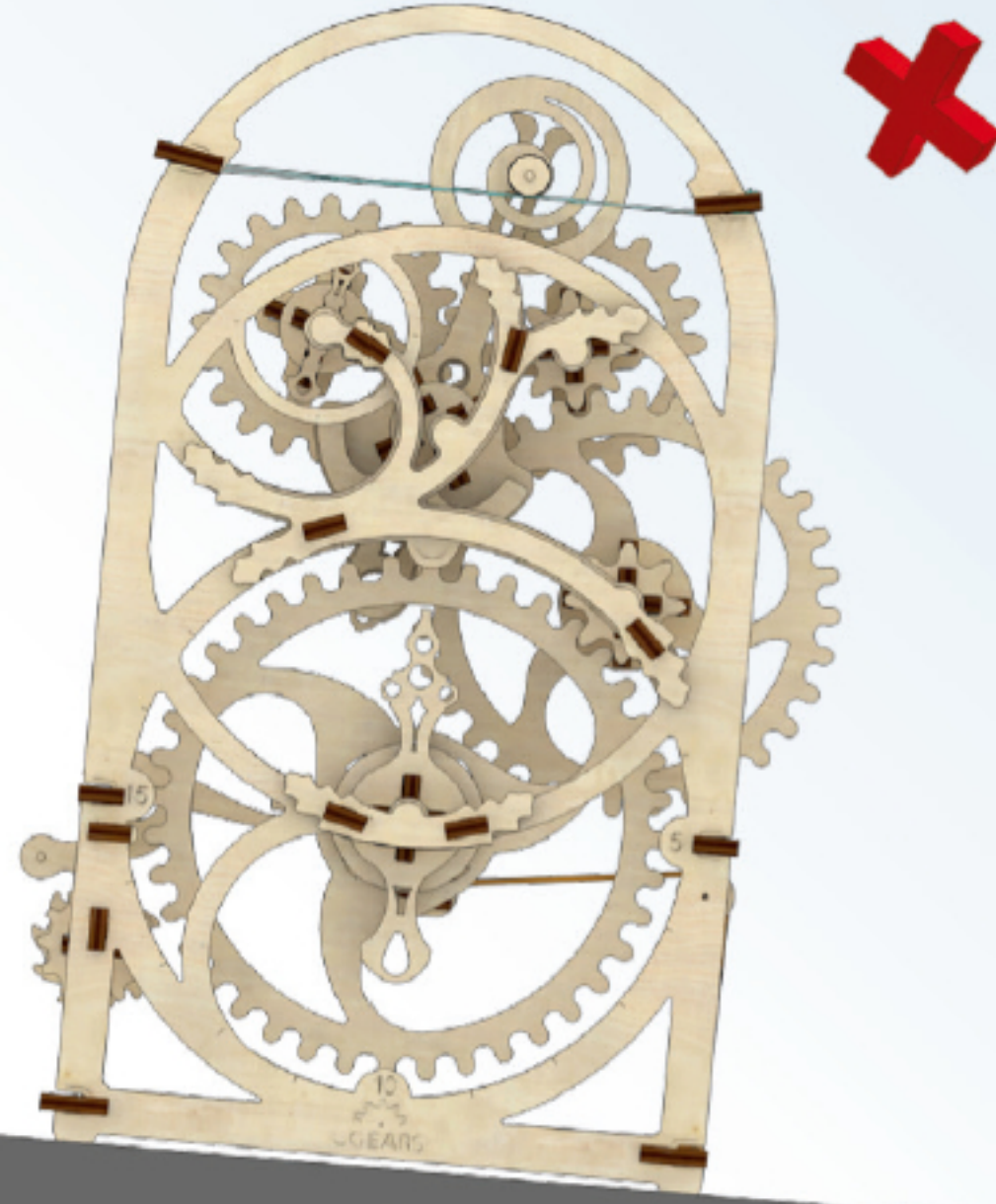



## Probleemoplossen

1

Controleer alle tandwielvlakken en roloppervlakken op ruwheid en verwijder deze. (figuur 3)

2

Controleer of tandwielen en andere bewegende delen correct zijn geplaatst en soepel kunnen bewegen en raak de zijpanelen *niet* aan op punten die worden aangegeven. (figuur 4)

#3

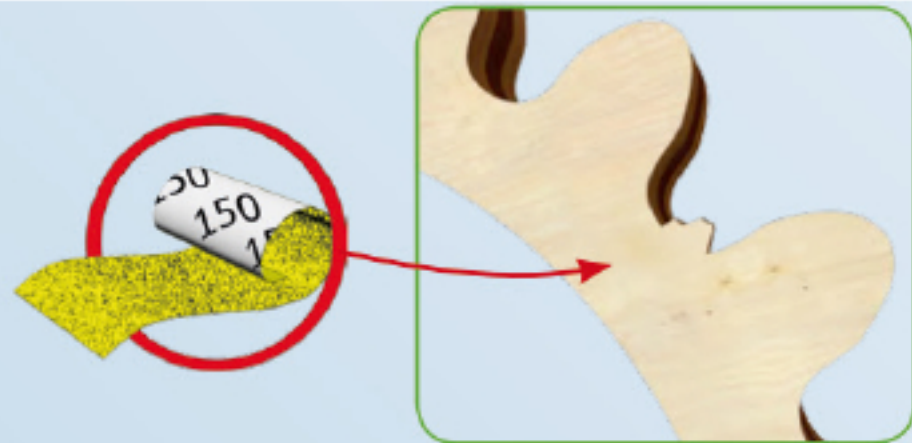

#4

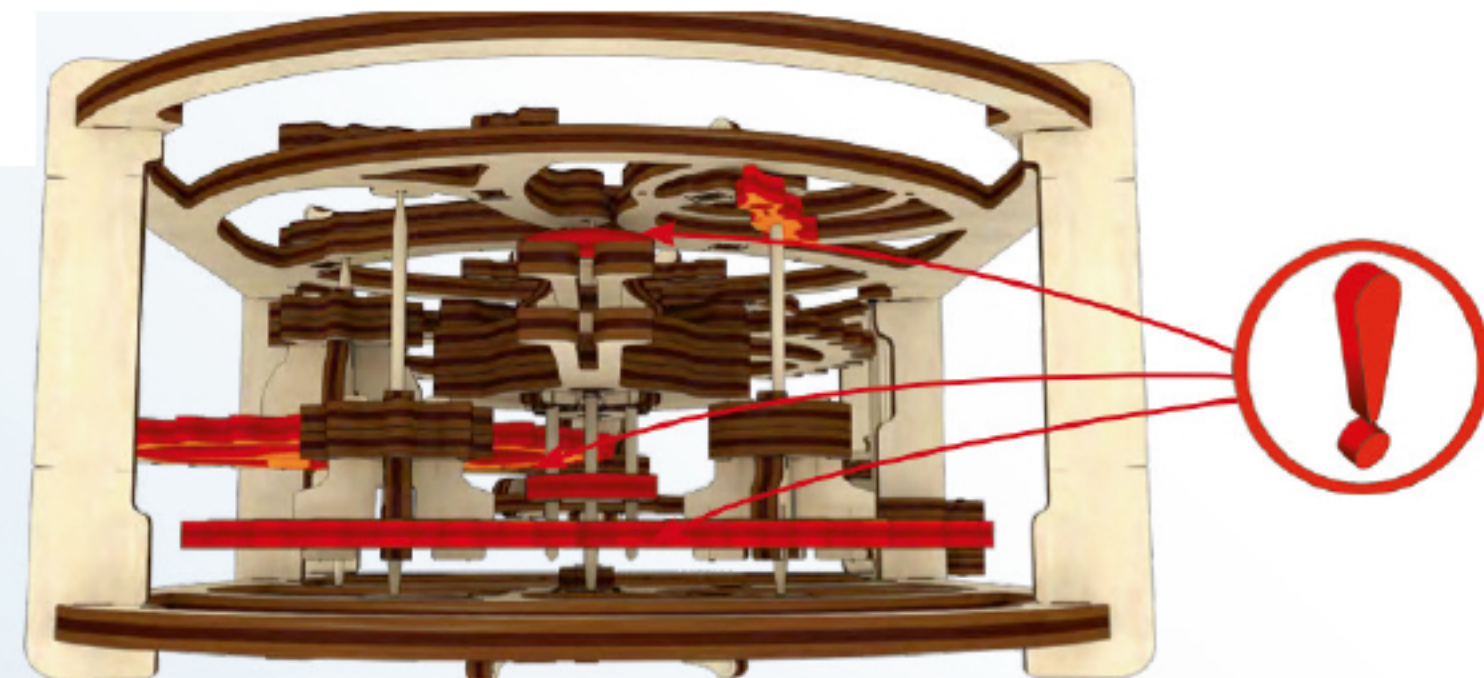

3

Draai de pijl naar rechts en start de timer. Stel de regelaar aan de achterkant van de timer in op midden. Verwijder de bovenste rol van de slinger. Draai de regelaar naar (-) om de slingerboog te verkorten en de timer te versnellen. Draai de regelaar naar (+) om de slingerboog te vergroten en de timer te vertragen. Als de slinger niet meer beweegt, draait u de regelaar naar (-). Als de timer loopt en vervolgens stopt, controleer dan alle tandwielvlakken en rolloppervlakken op ruwheid en verwijder deze. (figuur 5)



#5

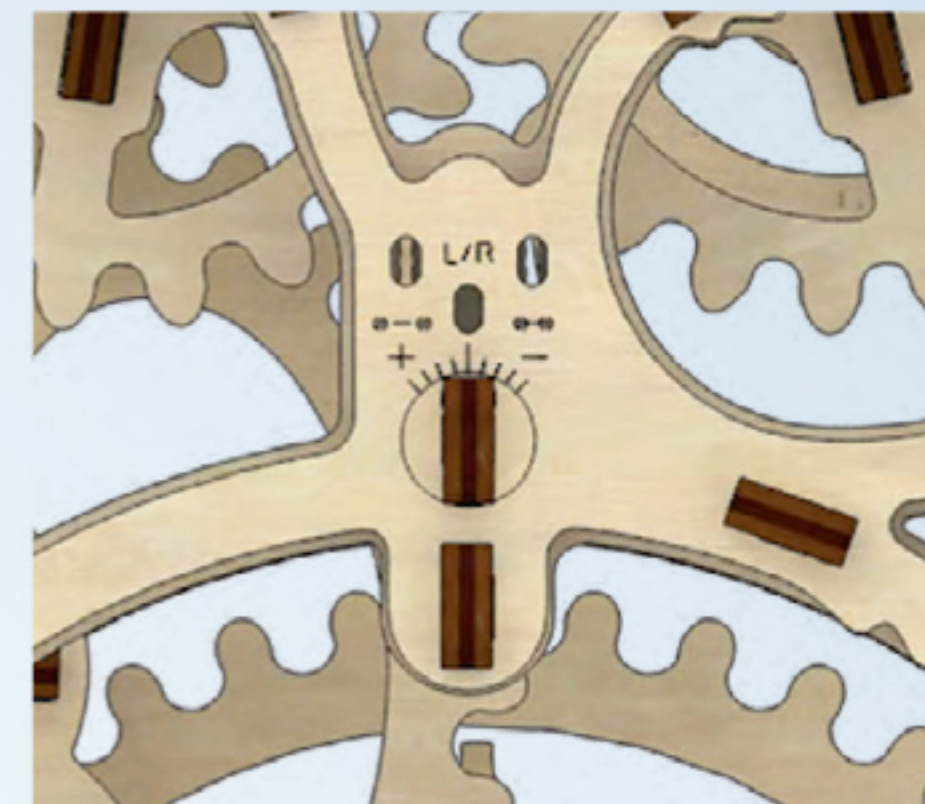

4

Gebruik massief kaarsvet om de cilinder in te smeren en plaats de cilinder in de slinger. Vergelijk de timer met een standaard klok. Pas de spanning in het elastiek aan. Als de timer nog steeds niet continu loopt, verhoog dan de spanning in het elastiek. Als de timer onregelmatig werkt, verlaag dan de spanning in het elastiek. (figuur 6)

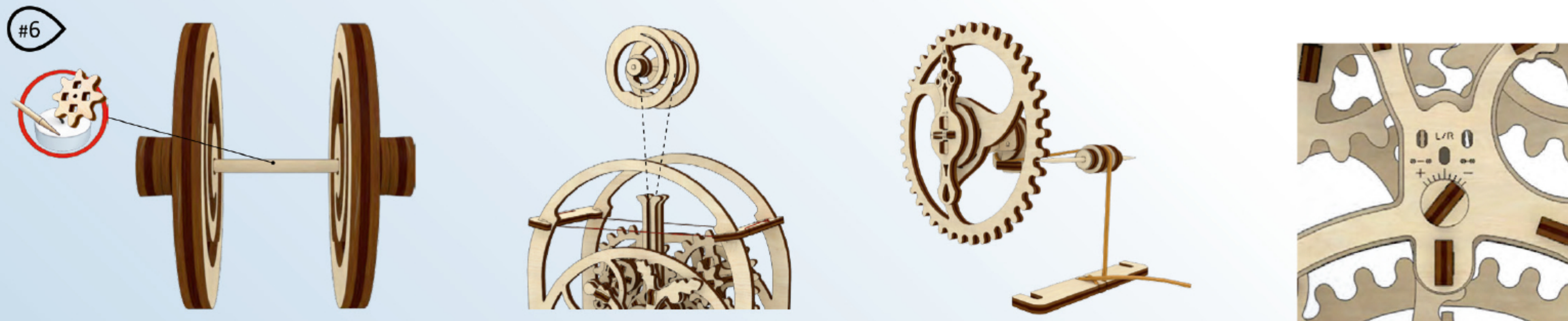



- 5 Als de slinger en de cilinder onregelmatig blijven werken nadat alle bovenstaande stappen voor probleemoplossing zijn uitgevoerd: Haal de slinger uit de timer, verwijder alle drie de assen van de slinger en vervang de assen door een nieuwe. Zorg ervoor dat de nieuwe assen recht zijn en dat alle onderdelen goed zijn geplaatst. Smeer de pendelassen in met massief kaarsvet. (Figuur 7)

