

Assemble me.
Take an ocean voyage
with me!



Find out MORE



UGEAR'S®
Mechanical models

Ocean Beauty Yacht Яхта Океанська Красуня

FRA Yacht Beauté de l'océan DEU Jacht Ocean Beauty
SPA Yate Belleza de los Océanos
ITA Yacht Ocean Beauty
JPN オーシャンビューヨット CHI 海洋美景游艇
POR late Beleza dos Oceanos
POL Jacht Ocean Beauty KOR 오션 뷰티 요트

Assembly instructions Інструкція зі складання

FRA Notice d'assemblage. DEU Aufbauanleitung.
SPA Instrucciones de montaje. ITA Istruzioni di montaggio.
JPN 組み立て説明書 CHI 装配说明书
POR Instruções de montagem.
POL Instrukcja montażu. KOR 조립 설명서.



MECHANICAL
МЕХАНІЧНИ



NO GLUE CONNECTION
БЕЗ КЛЕЮ



PLYWOOD
З ФАНЕРИ

Mechanical models

ENG Warning! **UKR** Увага! **FRA** Attention! **DEU** Achtung! **SPA** Precaución!
ITA Attenzione! **JPN** 注意! **CHI** 注意! **POR** Atenção! **POL** Uwaga! **KOR** 주의!



ENG Do not use a lighted candle! **UKR** Не підпалювати!
FRA Ne pas brûler! **DEU** Nicht anzünden!
SPA ¡No encender! **ITA** Non dare fuoco!
JPN 火のついたろうソクの使用はお止めください。
CHI 请勿点燃，请勿靠近火源!

POR Não use uma vela acesa para este propósito!
POL Nie podpalać! **KOR** 불이 붙은 초를 이용하지 마세요!



ENG Specified details come with spare duplicates
UKR Зазначені деталі є на дошках як запасні.
FRA Les détails spécifiés sont fournis avec des doublons de rechange. **DEU** Die angegebenen Details werden mit Ersatzduplikaten geliefert. **SPA** Los detalles especificados vienen con duplicados de repuesto. **ITA** I dettagli specificati vengono forniti con duplicati di riserva. **JPN** 指定された詳細には予備の複製が付属しています。 **CHI** 指定的細節帶有備用副本。 **POR** Os detalhes especificados vêm com peças sobressalentes duplicadas. **POL** Zapasowe elementy są zaznaczone na desce. **KOR** 명시된 세부 사항은 여분의 복사본과 함께 제공됩니다.

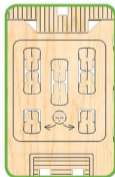

ENG Symbols. **UKR** Умовні позначення. **FRA** Légende. **DEU** Legende. **SPA** Leyenda. **ITA** Legenda.
JPN 記号 **CHI** 图标含义 **POR** Símbolos. **POL** Oznaczenia umowne. **KOR** 기호.



ENG Pay attention. Check position of the part. **UKR** Зверніть увагу. Перевірте розташування елемента. **FRA** Faites attention. Vérifiez la disposition de l'élément. **DEU** Bitte Beachten. Prüfen Sie die Einbaulage des Elementes. **SPA** Atención. Compruebe la situación del elemento. **ITA** Prestare attenzione. Controllare la posizione del componente. **JPN** 方向及び位置に注意して組み立ててください。 **CHI** 注意! 检查部件方向和位置 **POR** Preste atenção à posição da peça. **POL** Zwróć uwagę. Sprawdź lokalizację elementu. **KOR** 방향 또는 위치에 주의해서 조립해 주세요.



ENG Wax the part with a regular candle (rub with a candle). **UKR** Змастіть деталь звичайною свічкою (потріть об свічку). **FRA** Lubrifiez la pièce avec une bougie ordinaire (frottez contre la bougie). **DEU** Reiben Sie das Teil mit einer einfachen Kerze etwas ein. **SPA** Engrase la pieza con una vela común (frote con una vela). **ITA** Incerare il componente (Sfregare con la cera). **JPN** された部分に潤滑剤としてろうソクを塗ってください。 **CHI** 用普通蜡烛涂抹润滑部件 **POR** Encere a peça com uma vela comum (esfregue em uma vela). **POL** Przesmaruj zwykłą świecą. **KOR** 표시된 부분에 윤활을 위해 초를 칠해 주세요.

ENG It's easier to pull out some parts with the «helper (H)». **UKR** Буде легше видавити готові деталі за допомогою «helper (H)». **FRA** Il est plus facile de retirer certaines pièces avec la pièce-outils (H). **DEU** Es ist einfacher, einige Teile mit dem "Helfer (H)" herauszunehmen. Siehe Beispiel: **SPA** Para separar algunas partes resulta más fácil utilizando la ayuda del elemento "H". **ITA** È più facile estrarre alcuni elementi utilizzando l'"aiuto (H)". **JPN** ある部品は「helper (H)」を使うと取り外しやすいです。 **CHI** 使用「helper (H)」可以更轻松地拉出某些零件。 **POR** É mais fácil retirar algumas peças usando a «peça auxiliar(H)». **POL** Niektóre części łatwiej jest wyciągnąć za pomocą "pomocnika (H)". **KOR** 일부 부품은 'H' 도구를 이용하여 떼어내면 쉽습니다.

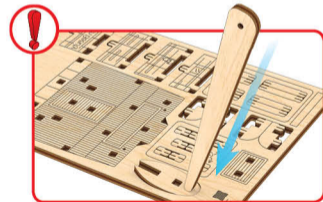

1

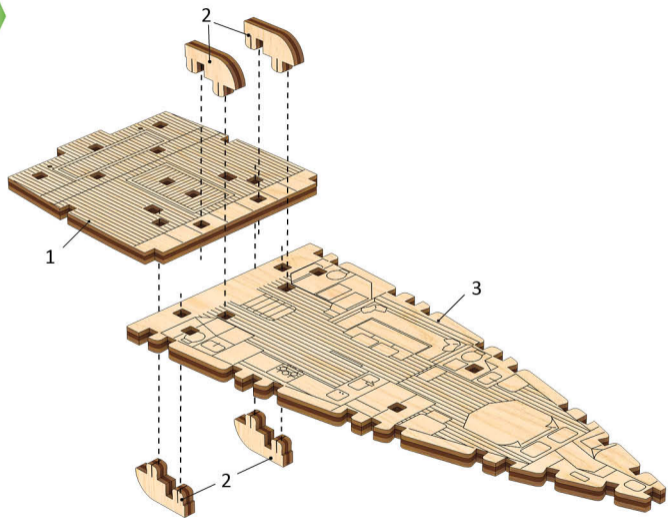

2

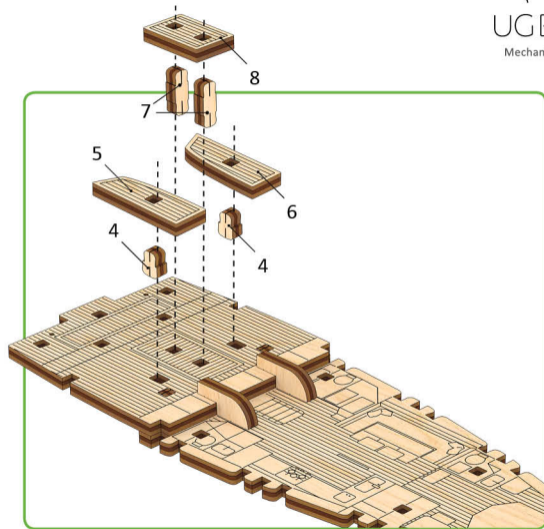

3

3

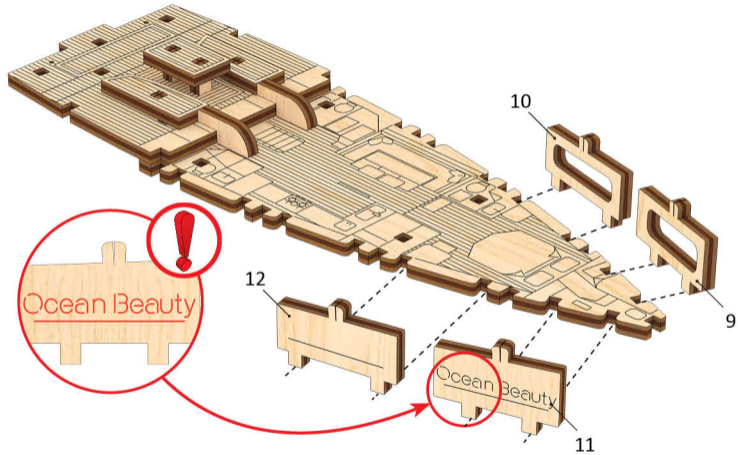

4

4

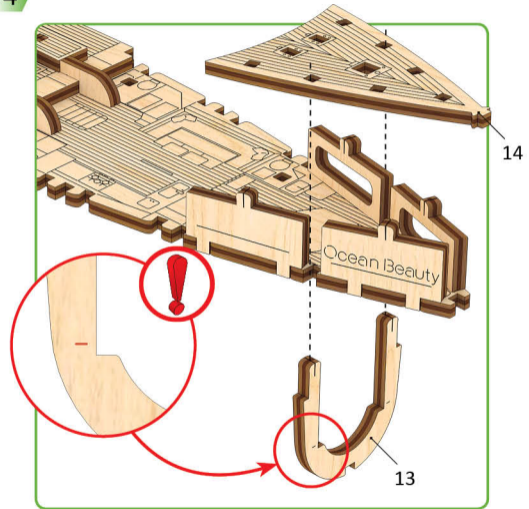

5

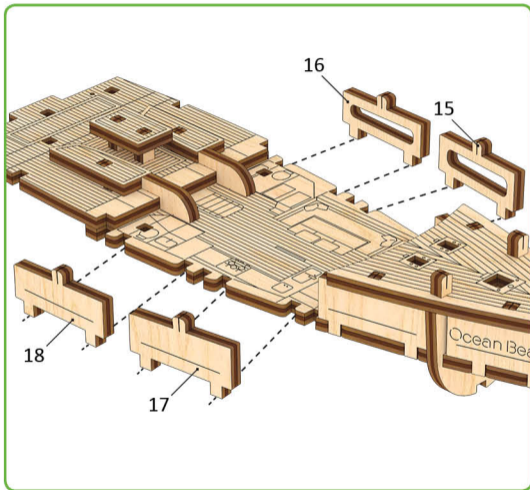

6

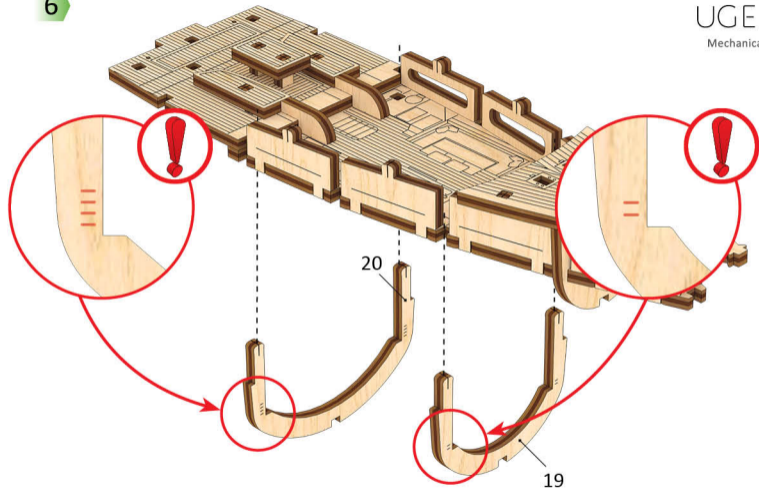

7

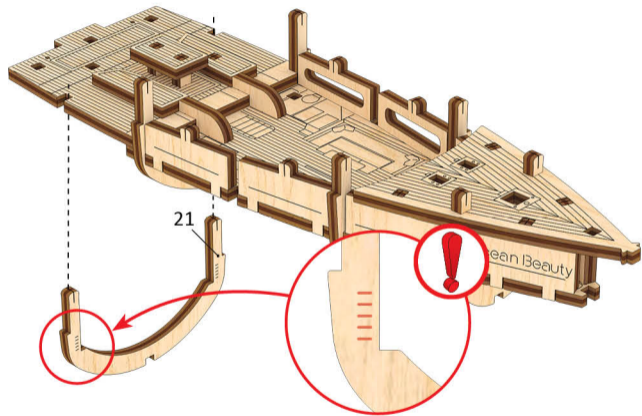

6

a1

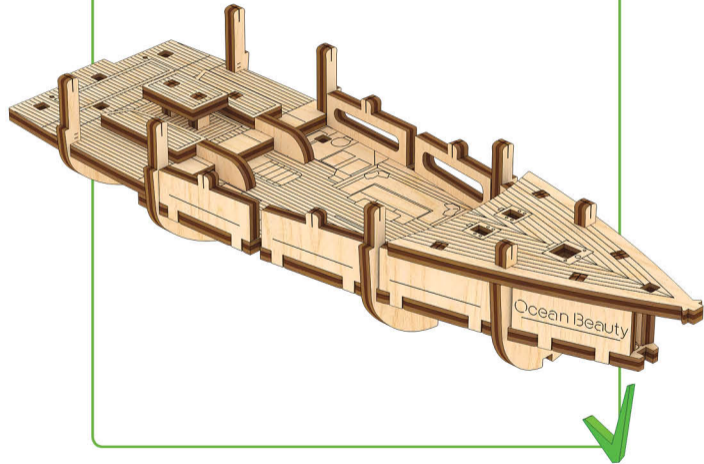

1

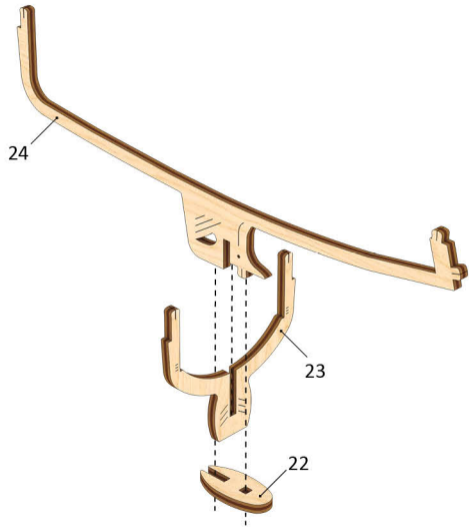

2

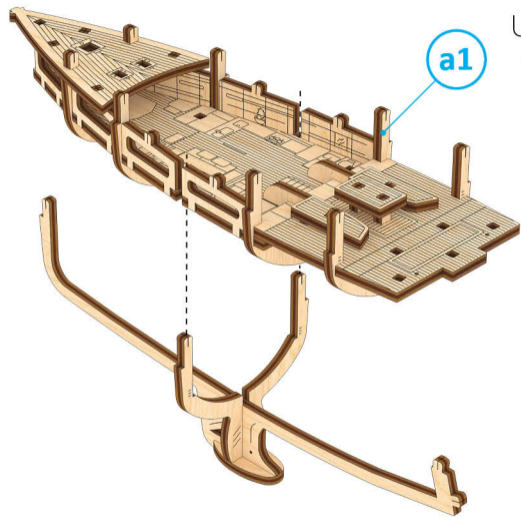

Mechanical models

3

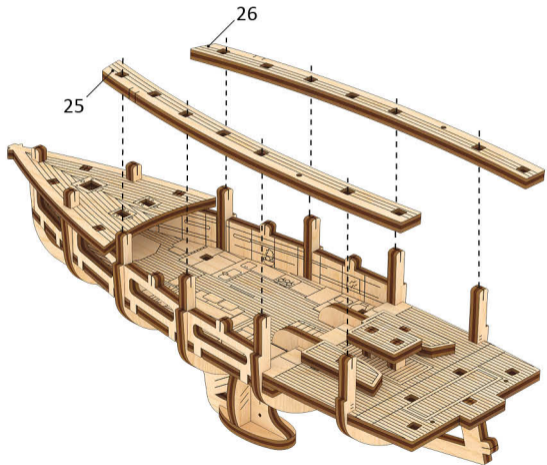

4

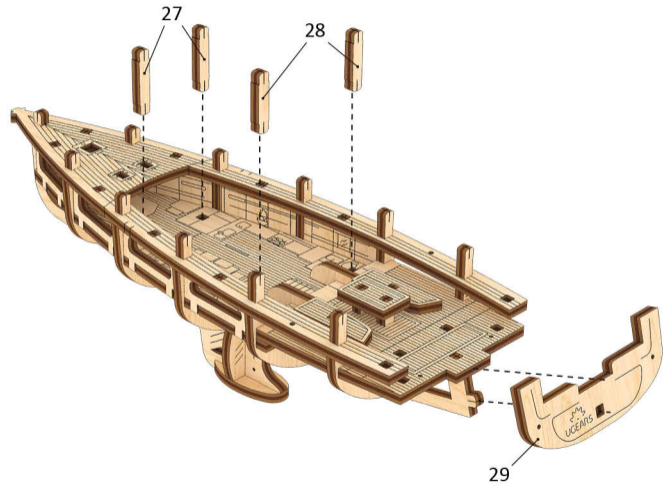

8

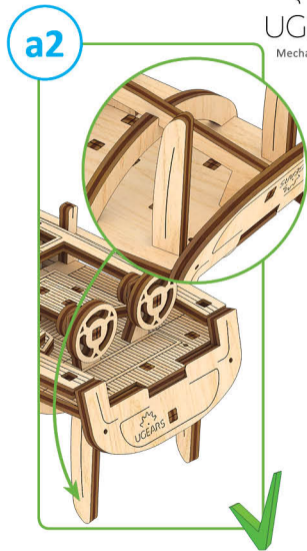
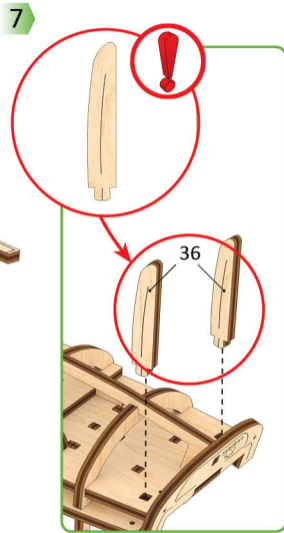
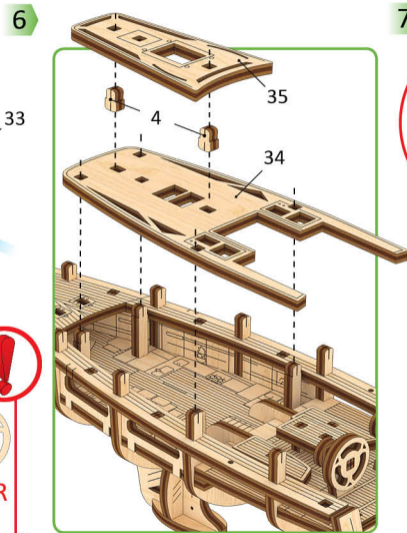
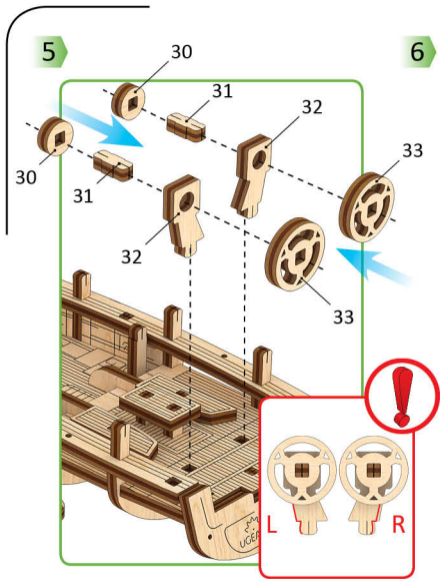

Mechanical models

1

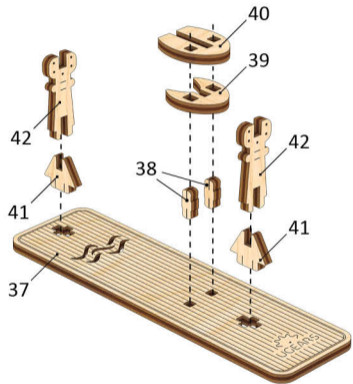

2

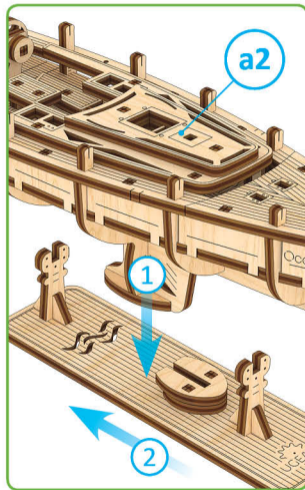

a3

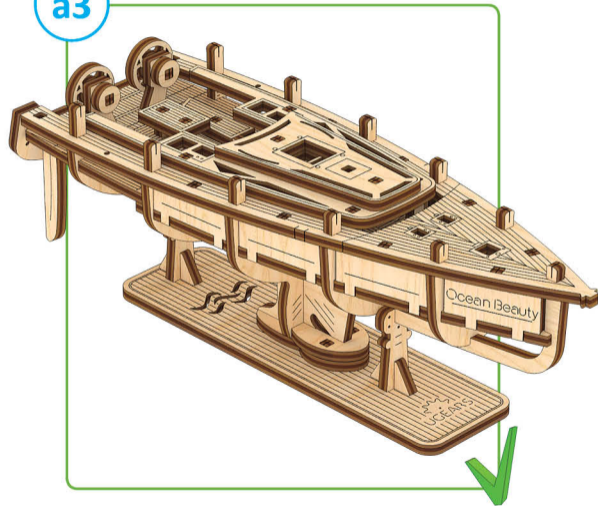

1

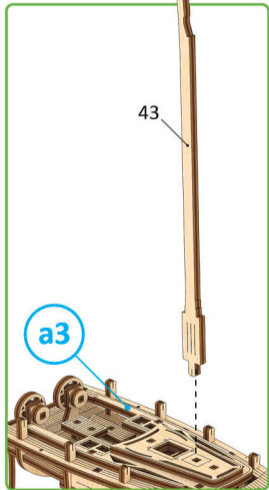

2

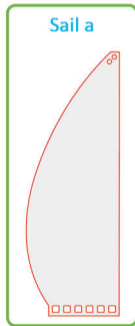

3

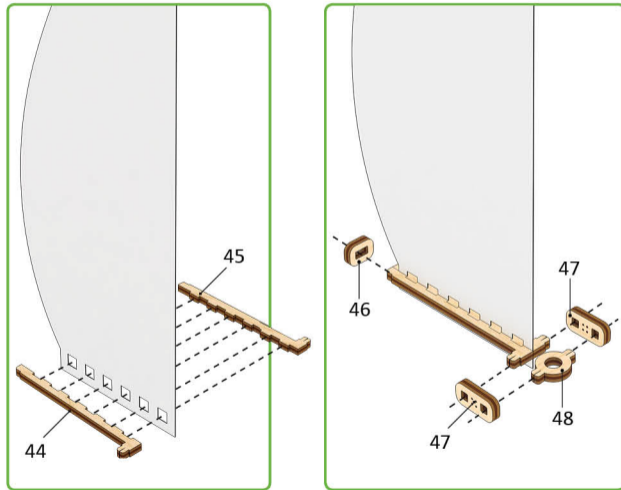

4

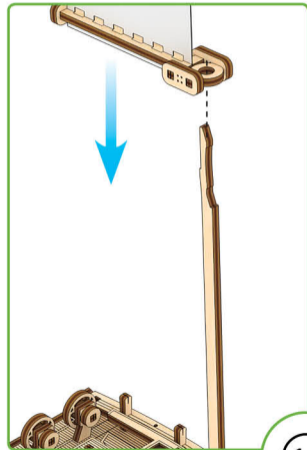

5

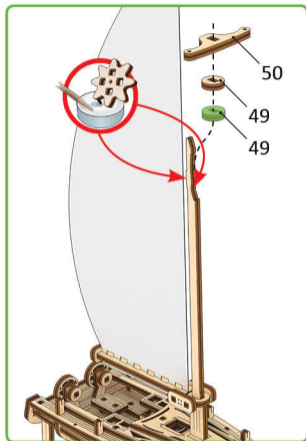

6

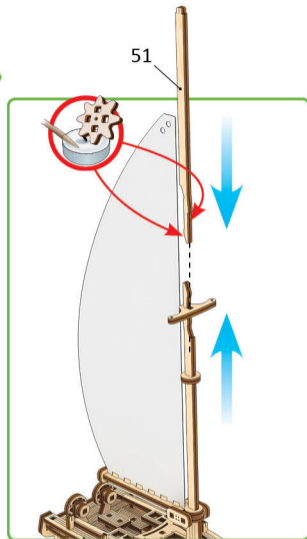

7

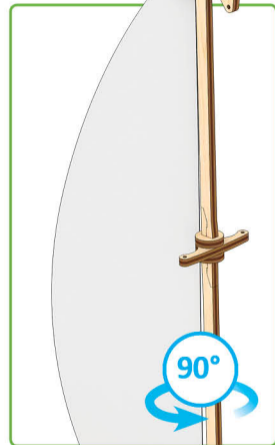
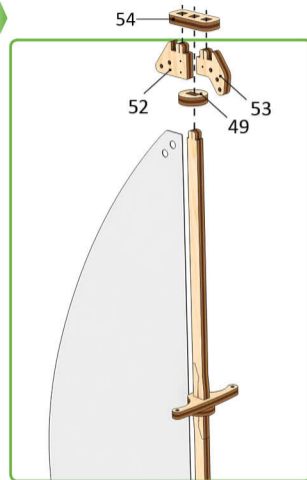

12



ENG Wax the part with a regular candle (rub with a candle). UKR Змастіть деталь звичайною свічкою (потріть об свічку). FRA Lubrifiez la pièce avec une bougie ordinaire (frottez contre la bougie). DEU Reiben Sie das Teil mit einer einfachen Kerze etwas ein. SPA Engrase la pieza con una vela común (frote con una vela). ITA Incerare il componente (Sfregare con la cera). JPN された部分に潤滑剤としてロウソクを塗ってください。CHI 用普通蜡烛涂抹润滑部件 POR Encere a peça com uma vela comum (esfregue em uma vela). POL Przesmaruj zwykłą świecę. KOR 표시된 부분에 윤활을 위해 초를 칠해 주세요.

8

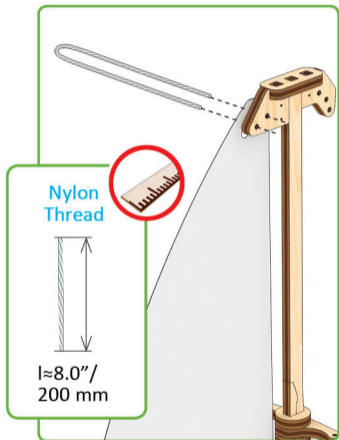

9

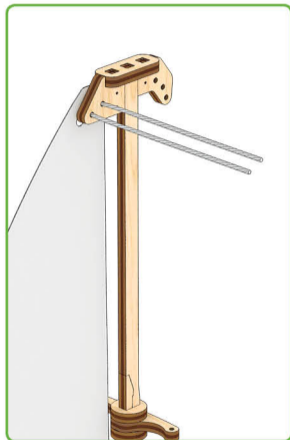

10

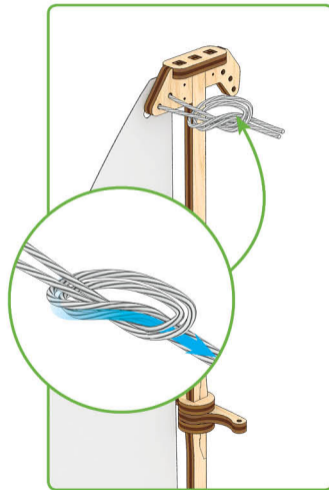

11

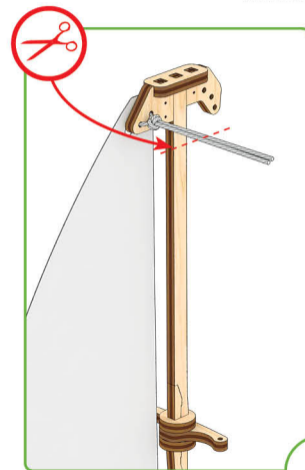

ENG Check size. UKR Перевірте розмір. FRA Vérifiez la dimension. DEU Prüfen Sie die Größe. SPA Compruebe el tamaño. ITA Controllare le dimensioni. JPN サイズをチェックしてください。CHI 測量尺寸 POR Verifique o tamanho. POL Sprawdz rozmiar. KOR 크기를 확인해 주세요.

Mechanical models

12

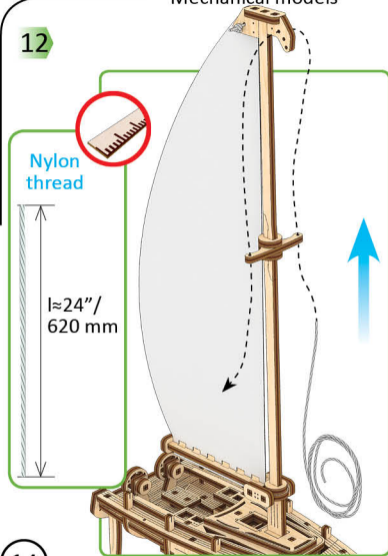

13

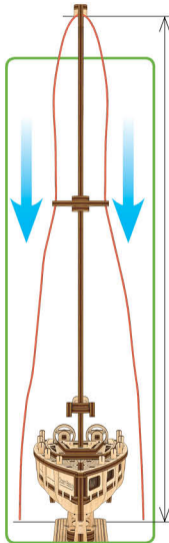

14

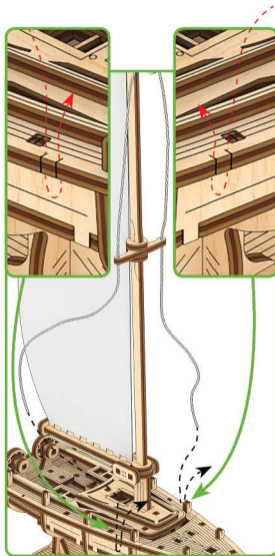

15

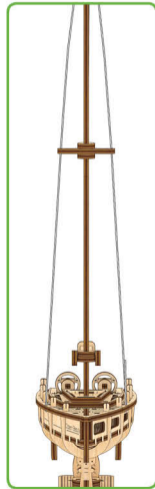

a4

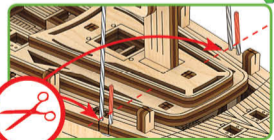
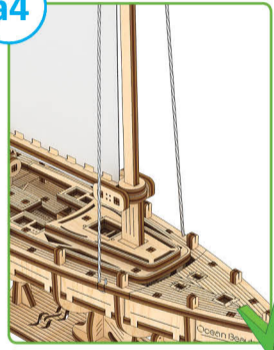

14

1

x2



Nylon
thread

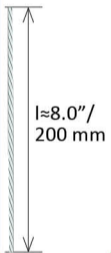

Sail b

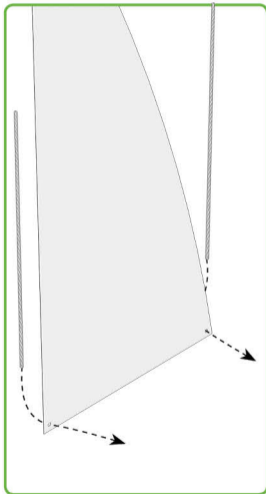
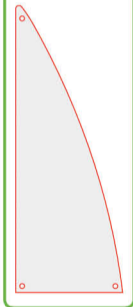

1

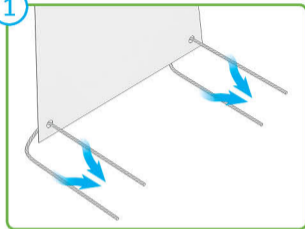

2

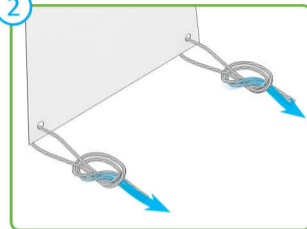

3

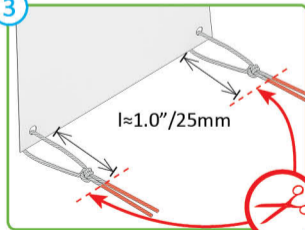

a5

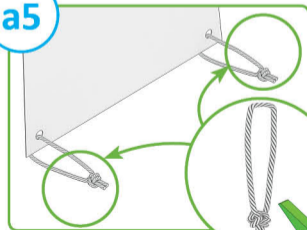

Mechanical models

1

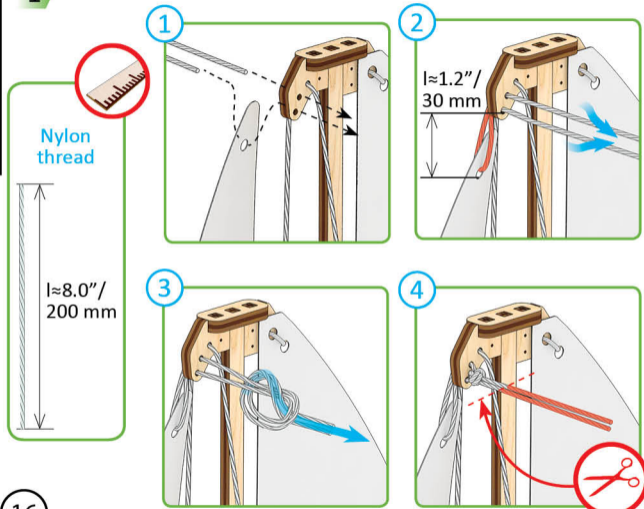

2

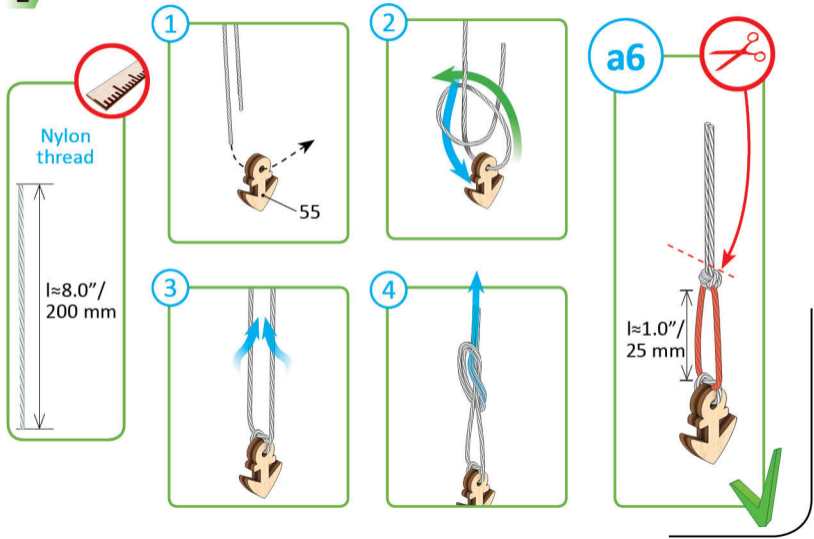

1

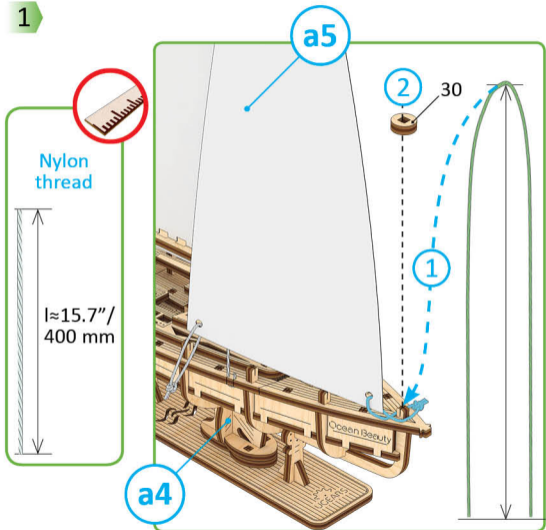

2

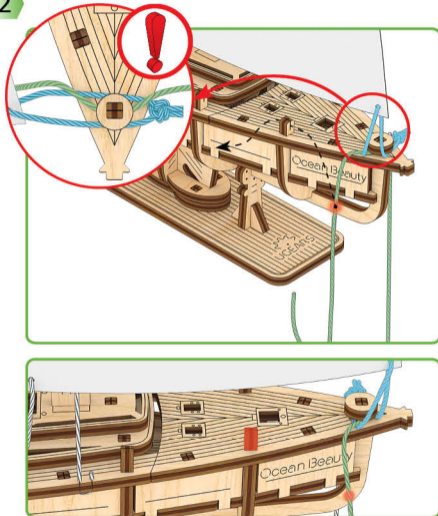

3

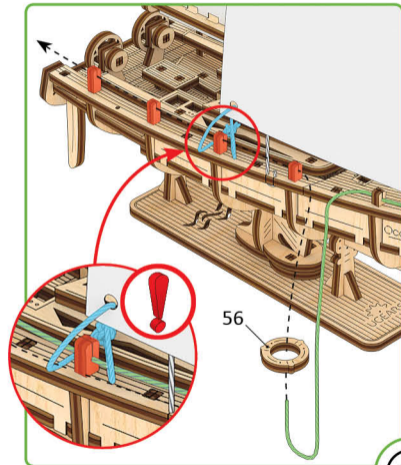

4

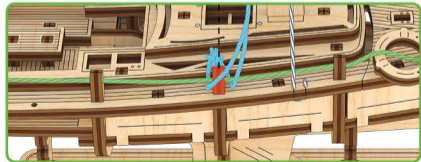
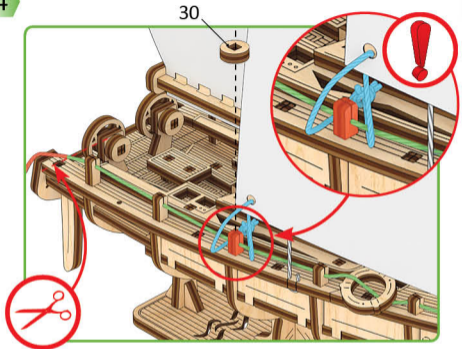

5

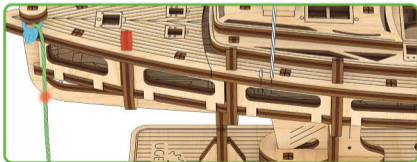
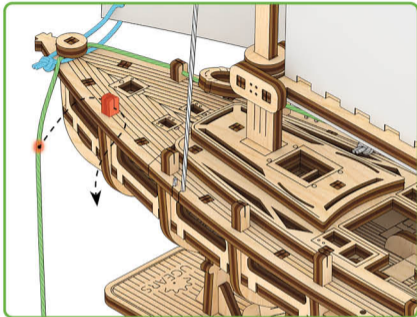

6

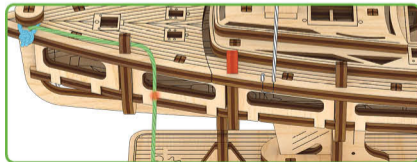
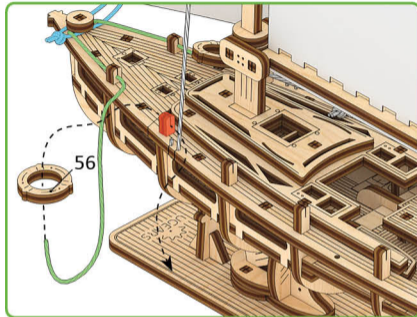

7

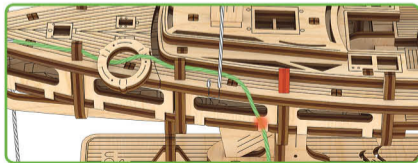
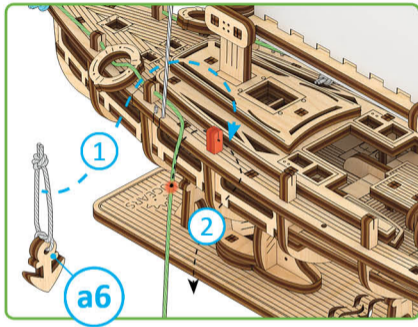

8

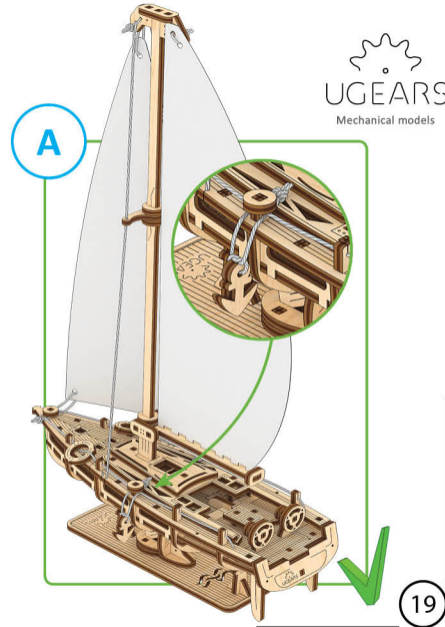
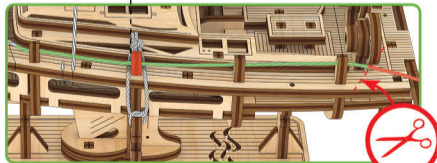
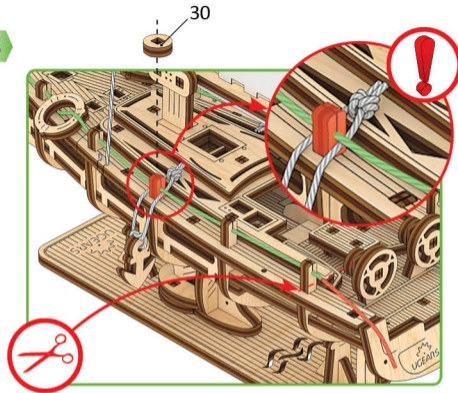

19

Mechanical models

1

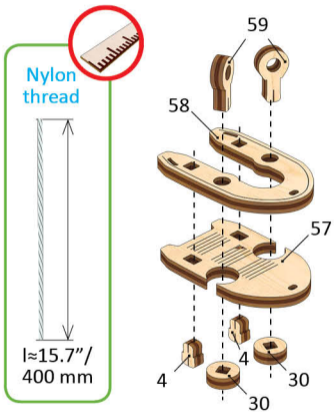

2

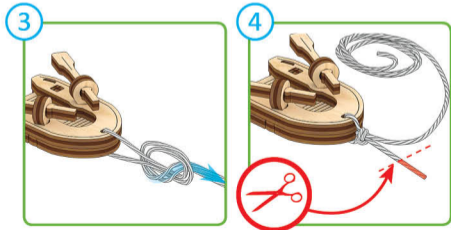
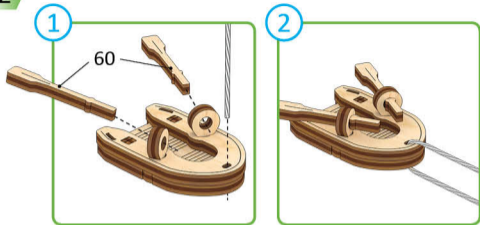

3

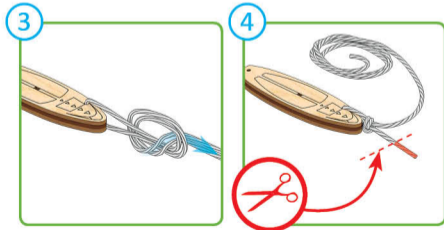
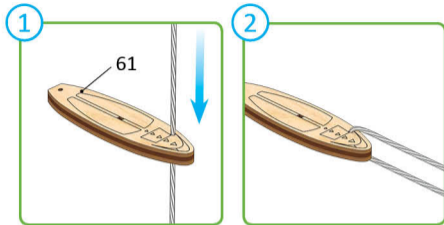
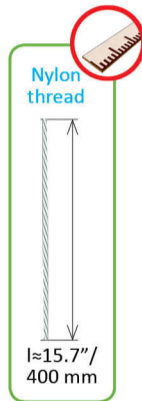

4

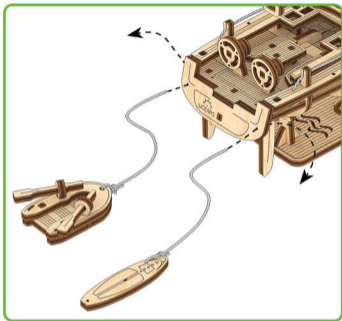

5

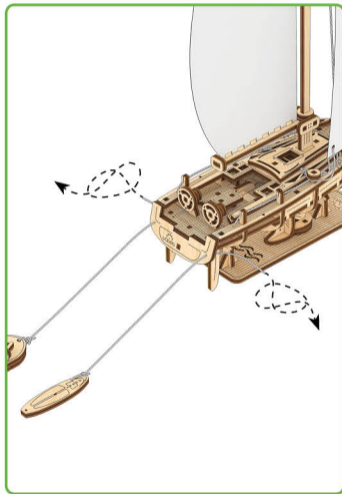

6

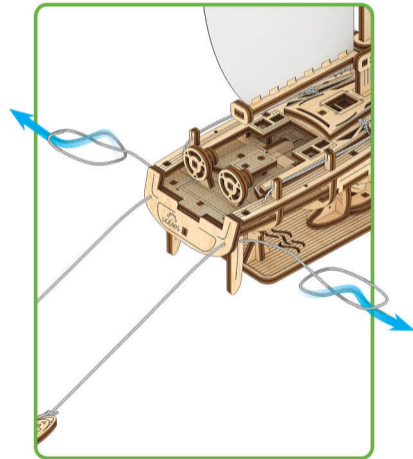

7

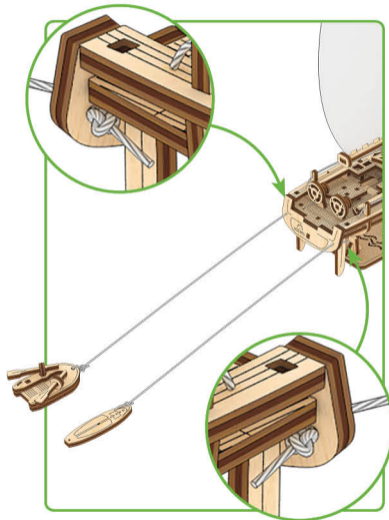
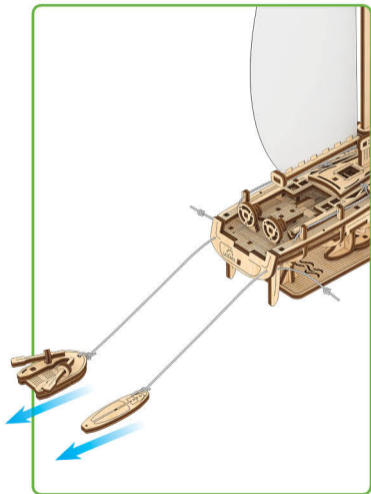

8

Flag

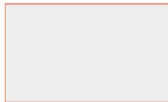

1.3x0.8" / 34x20 mm

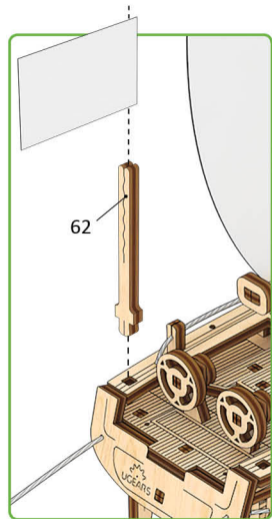

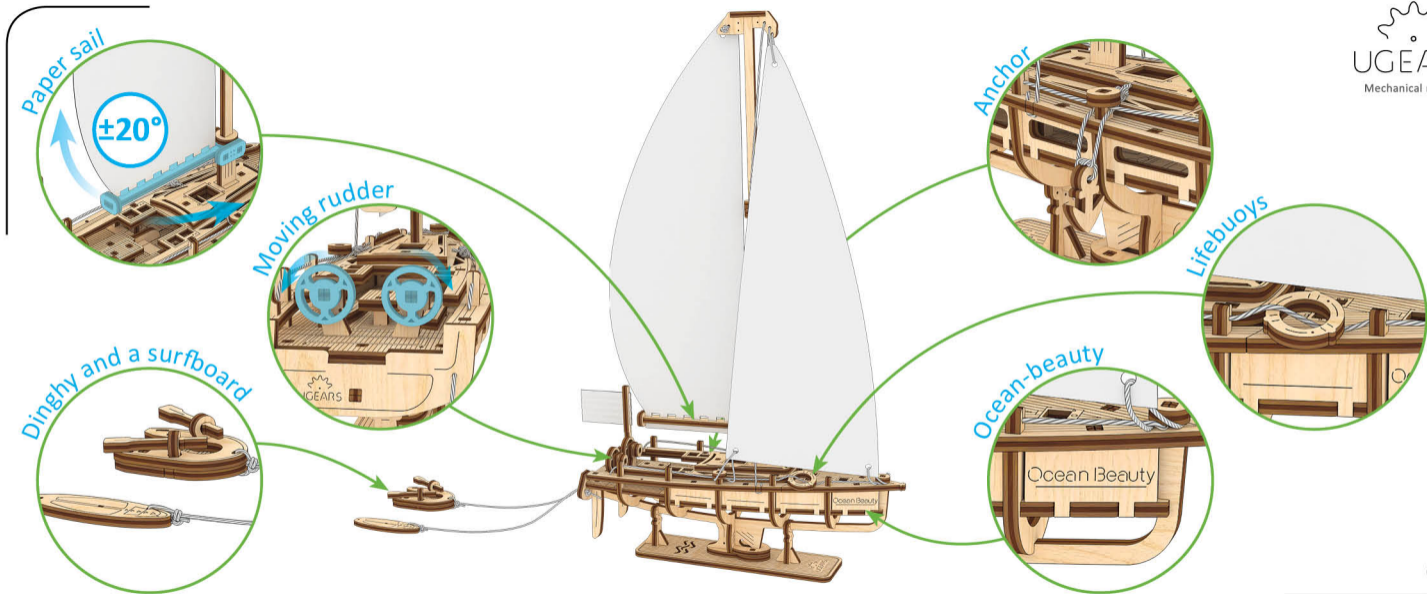



UGEAR'S®
Mechanical models

ENG Thanks for following along on this journey with us.

UKR Дякуємо, що ви пройшли цей шлях з нами.

FRA Merci denous avoir accompagnés tout au long de ces étapes.

DEU Vielen Dank, dass Sie diesen Weg mit uns gegangen sind.

SPA Gracias por haber recorrido el camino con nosotros.

ITA Grazie per aver fatto uesto percorso con noi.

JPN UGEARSをご利用いただきありがとうございます

CHI 感谢您参与有趣的模型拼装过程。

POR Obrigado por nos acompanhar nessa jornada.

POL Dziękujemy, że razem z nami pokonałeś tę drogę!

KOR UGEARS 와 함께해 주셔서 감사합니다.

ugearsmodels.com

ENG Customer support **UKR** Служба підтримки

FRA Service client **DEU** Kundendienst

SPA Servicio al cliente **ITA** Servizio di supporto

JPN お客様窓口 **CHI** 客户支持 **POR** Suporte ao cliente

POL Wsparcie klienta **KOR** 고객지원

customerservice@ugearsmodels.com